

Panasonic®

Operating Instructions

**SONIC
STEAMER™**

Commercial Microwave Ovens

NE-2180/NE-3280

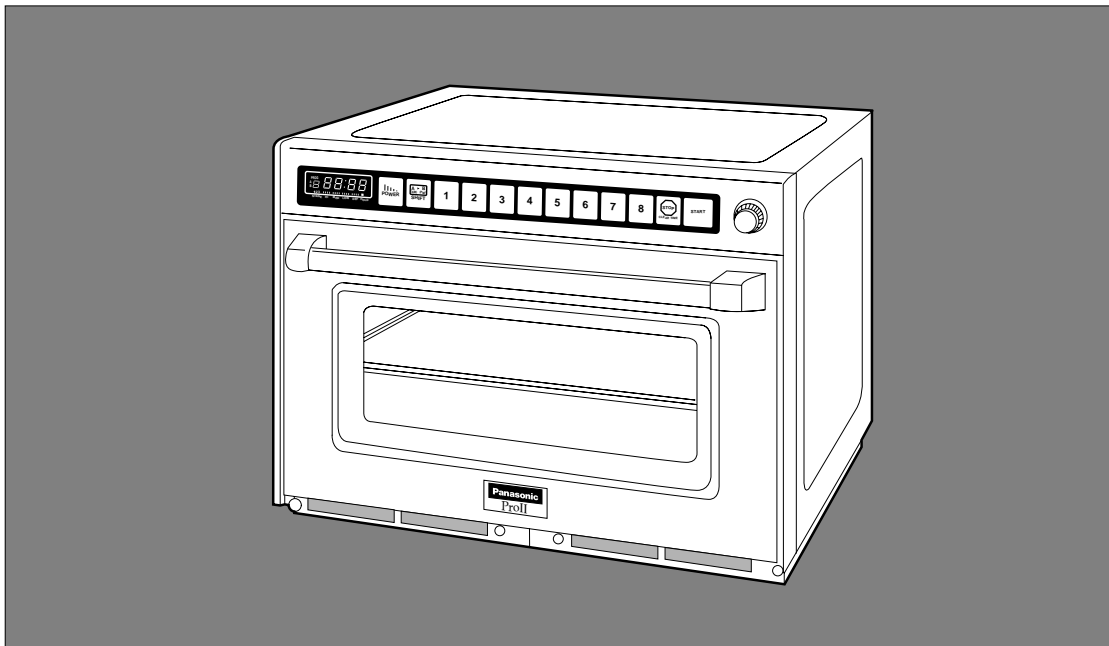

Please read these instructions completely before operating this oven.

Before Calling for Service:

If failure code "F**" appears in the display, unplug oven and wait for 10 seconds before reconnecting. If normal operation does not resume, call the service agent with the information of failure code.

Contents

PRECAUTIONS TO AVOID POSSIBLE EXPOSURE TO EXCESSIVE
 MICROWAVE ENERGY3
 IMPORTANT SAFETY INSTRUCTIONS3
 Installation and Grounding Instructions4
 Power Source Voltage Adjustment5
 How Does The Microwave Work?5
 Outline Diagram6
 How to Operate
 A. Manual Heating . .single stage heating7
 2 or 3 stage heating8
 B. Programmed Heating9
 C. Programming Memory padssingle stage heating10
 2 or 3 stage heating11
 D. Program Lock11
 E. Beep Tone12
 F. Program List13
 G. Cycle Counter13
 Self Diagnostics Failure Code Explanation13
 Sanitary Counter Top Seal14
 Care of Your Oven14
 Cooking Instructions15
 Technical Specifications16

<p style="text-align: center;">Owner's Record</p> <p>Model No. _____ Serial No. _____</p> <p style="text-align: center; font-size: small;">The serial number of this products can be found on the lower right hand side of the oven.</p> <p>Dealer's Name _____ Dealer's Address _____ Date of Purchase _____</p>	<p style="text-align: center; font-size: small;">See page 13 before calling</p> <p style="text-align: center;">Toll Free Service Information</p> <p style="text-align: center; font-size: small;">To locate a convenient service agent call</p> <p style="text-align: center;">1-888-350-9590</p> <p style="text-align: center; font-size: small;">Chef Support: 201-348-7305 www.panasonic.com/cmo Virtual Test Kitchens</p>
--	---

PRECAUTIONS TO AVOID POSSIBLE EXPOSURE TO EXCESSIVE MICROWAVE ENERGY

- (a) **Do not attempt to operate this oven with the door open** since open-door operation can result in harmful exposure to microwave energy. It is important not to defeat or tamper with the safety interlocks. Under normal conditions, the oven will not operate with the door open.
- (b) **Do not place any object** between the oven front face and the door, or allow soil or cleaner residue to accumulate on sealing surfaces.
- (c) **Do not operate the oven** if it is damaged. It is particularly important that the oven door close properly and that there is no damage to the :
 - (1) door (bent)
 - (2) hinges and latches (broken or loose)
 - (3) door seals and sealing surfaces.
- (d) **The oven should not be adjusted or repaired** by anyone except properly qualified service personnel. (See page 2.)

IMPORTANT SAFETY INSTRUCTIONS

Your microwave oven is a cooking device and you should use as much care as you use with a stove or any other cooking device.

When using this electric appliance, basic safety precautions should be followed, including the following:

WARNING—To reduce the risk of burns, electric shock, fire, injury to persons or exposure to excessive microwave energy:

1. Read all instructions before using the appliance.
2. Read and follow “**PRECAUTIONS TO AVOID POSSIBLE EXPOSURE TO EXCESSIVE MICROWAVE ENERGY,**” above on this page.
3. This appliance must be grounded. Connect only to a properly grounded outlet. See “**Grounding Instructions**” found on page 4.
4. Install or locate this appliance only in accordance with the provided installation instructions found on page 4.
5. Do not cover or block any openings on this appliance.
6. Do not store or use this appliance outdoors. Do not use this product near water—for example, near a kitchen sink, in a wet basement, or near a swimming pool, and the like.
7. Use this appliance only for its intended use as described in this manual. Do not use corrosive chemicals or vapors in this appliance. This type of oven is specifically designed to heat, or cook food. It is not designed for industrial or laboratory use.
8. When cleaning surfaces of door and oven that come together on closing the door, use only mild, non-abrasive soaps or detergents applied with a sponge or soft cloth.
9. As with any appliance, close supervision is necessary when used by children.
10. Do not operate this appliance if it has a damaged cord or plug, if it is not working properly, or if it has been damaged or dropped.
11. Do not immerse cord or plug in water.
12. Keep cord away from heated surfaces.
13. Do not let cord hang over edge of table or counter.
14. This appliance should be serviced only by qualified service personnel. Contact the nearest authorized service facility for examination, repair or adjustment.
15. Some products such as whole eggs and sealed containers (for example, closed glass jars) may explode and should not be heated in this oven.
16. To reduce the risk of fire in the oven cavity:
 - (a) Do not overcook food. Carefully attend appliance if paper, plastic, or other combustible materials are placed inside the oven to facilitate cooking.
 - (b) Remove wire twist-ties from paper or plastic bags before placing bag in oven.
 - (c) If materials inside the oven should ignite, keep oven door closed, turn oven off, and disconnect the power cord, or shut off power at the fuse or circuit breaker panel.
 - (d) Do not use the cavity for storage purposes. Do not leave paper products, cooking utensils, or food in the cavity when not in use.
17. Liquids, such as water, coffee, or tea are able to be overheated beyond the boiling point without appearing to be boiling due to surface tension of the liquid. Visible bubbling or boiling when the container is removed from the microwave oven is not always present. **THIS COULD RESULT IN VERY HOT LIQUIDS SUDDENLY BOILING OVER WHEN A SPOON OR OTHER UTENSIL IS INSERTED INTO THE LIQUID.** To reduce the risk of injury to persons:
 - (a) Do not overheat the liquid.
 - (b) Stir the liquid both before and halfway through heating it.
 - (c) Do not use straight-sided containers with narrow necks.
 - (d) After heating, allow the container to stand in the microwave oven for a short time before removing the container.
 - (e) Use extreme care when inserting a spoon or other utensil into the container.

SAVE THESE INSTRUCTIONS

For proper use of your oven read remaining safety cautions and operating instructions.

Installation and GROUNDING INSTRUCTIONS

Placement of the Oven

Locate the oven on a smooth, flat and stable surface. There should be no gap between the table surface and the bottom of the oven. Do not place the oven in a hot or damp area, ie. near a stove, sink or directly above heat lamps on a serving line. Free airflow around the oven is important. There is a possibility of a small amount of interference with weak broadcast signals if the microwave oven is too close to a radio or TV.

Grounding Instructions

This oven must be electrically grounded. In the event of an electrical short circuit, grounding reduces the risk of electric shock by providing an escape wire for the electric current. The appliance is equipped with a cord having a grounding wire with a grounding plug. The plug must be plugged into an outlet that is properly installed and grounded.

WARNING — improper use of the grounding plug can result in a risk of electric shock.

Consult a qualified electrician or service person if the grounding instructions are not completely understood, or if doubt exists as to whether the appliance is properly connected.

Do not use an extension cord. If the power supply cord is too short, have a qualified electrician or serviceman install an outlet near the appliance.

Removal of Protective Film

A blue protective film is used to prevent scratching of the outer case during transportation. Peel the film from the exterior of the oven before installation or use.

Wiring Requirements

1. No other appliance should share the circuit with the microwave oven. If it does, the branch circuit fuse may overload and either cause the oven to produce lower power output or blow the fuse.
2. The microwave ovens are built to operate on 2 different voltages (220-240 V or 208 V). Be sure that the voltage selector connector (on the back of the oven) is set for your power supply (see page 5). Using a higher voltage setting is dangerous and may result in overheating of the electrical components thus shortening their life expectancy or possibly causing a fire or other accident. Using a lower voltage will lower the power output of the oven, resulting in slower heating of the food. Panasonic is NOT responsible for damage resulting from the use of the oven with other than the specified voltage.

For Model NE-3280/NE-2180

This oven must be on a separate 60 Hz
GROUNDED CIRCUIT - minimum 30 amps.

NEMA#
6-30P

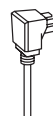

NEMA# 6-30R
Grounded Outlet



Caution

1. Do not attempt to tamper with or make any adjustments or repairs to the door, control panel housing, safety interlock switches or any other part of the oven. Do NOT remove the outer panel of the oven. Repairs should only be done by a qualified service person.
2. Do NOT operate the oven empty. The microwave energy will reflect continuously throughout the oven if no food or water is present to absorb energy, this could damage the oven and result in the danger of a fire.
3. If a fire occurs in the oven, press the Stop/Clear time Pad and LEAVE THE DOOR CLOSED. Disconnect the power cord, or shut off the power at the fuse or circuit breaker panel.
4. Do NOT attempt to dry clothes, newspapers or other materials in the oven, as they may catch on fire.
5. Do NOT use recycled paper products, as they may contain impurities which may cause sparks and/or fires.
6. Do NOT use newspapers or paper bags for cooking.
7. Do NOT hit or strike the control panel. Damage to controls may occur.
8. POT HOLDERS may be needed when removing food from the oven. Heat is transferred from the hot food to the container.
9. Do NOT store flammable materials next to, on top of, or in the oven. It is a fire hazard.
10. Do NOT slide the removable middle shelf in or out when placing or removing food. This action could cause damage to the shelf or cause hot food to tip towards the operator.
11. Do NOT use this oven to heat chemicals or any other non - food products. Do NOT clean this oven with any product that is labeled as containing corrosive chemicals. **Heating of corrosive chemicals in this oven can cause microwave radiation leaks.**

Power Source Voltage Adjustment

Your microwave oven is factory set for 208 V operation. For 220 V - 240 V operation, the following adjustment **MUST** be made.

- (Step 1) Unplug the oven.
- (Step 2) Unscrew the voltage adjustment cover which is located on the back of the oven. Do not remove any other parts from the oven.
- (Step 3) Remove the connector from the white socket and rotate it 180 degrees and plug it into black socket. (see sketch)
- (Step 4) Reattach the voltage adjustment cover to the cabinet.
 - For 220 V - 240 V – Plug the connector into black socket.
 - For 208 V ——— Plug the connector into white socket.

CAUTION
Make sure that the power cord is unplugged before removing the voltage adjustment cover.

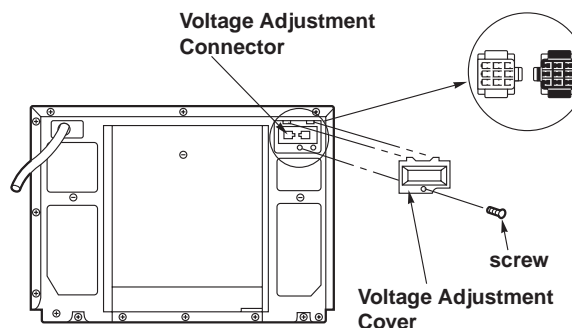

How Does The Microwave Work?

Microwaves are a form of high frequency radio waves similar to those used by a radio including AM, FM, and CB. They are, however, much shorter than radio waves; approximately five inches in length. Electricity is converted into microwave energy by the magnetron tube. From the magnetron tube, microwave energy is transmitted to the oven cavity where it is: reflected, transmitted and absorbed.

Reflection

Microwave are reflected by metal just as a ball is bounced off a wall. A combination of stationary (interior walls) and rotating antenna, located underneath the bottom shelf and above the ceiling cover assure that the microwaves are well distributed within the oven cavity to produce even heating or cooking of foods.

Transmission

Microwave pass through some materials such as paper, glass and plastic much like sunlight shining through a window. Because these substances do not absorb or reflect the microwave energy, they are ideal materials for microwave oven heating containers when covered.

Absorption

During heating, microwaves will be absorbed by food. They penetrate to a depth of about $\frac{3}{4}$ to $1\frac{1}{2}$ inches. Microwave energy excites the molecules in the food (especially water, fat and sugar molecules), and causes them to vibrate at a rate of 2,450,000,000 times per second. This vibration causes friction, and heat is produced just as you will feel heat produced if you vigorously rub your hands together. The internal heating of larger foods is done by conduction. The heat which is produced by friction is conducted to the center of the food. Foods also continue to heat by conduction during standing time. ("carry-over" cooking)
Because microwave energy dissipates, It is not stored in food.

Radio Inference

1. Operation of the microwave oven may cause interference to your radio, TV or similar equipment.
2. When there is interference, it may be reduced or eliminated by taking the following measures:
 - a. Clean door and sealing surfaces of the oven.
(See Care of Your Microwave Oven found on page 14.)
 - b. Place the radio, TV, etc. away from the microwave oven as far as possible.
 - c. Use a properly installed antenna, to obtain stronger signal reception.

Outline Diagram

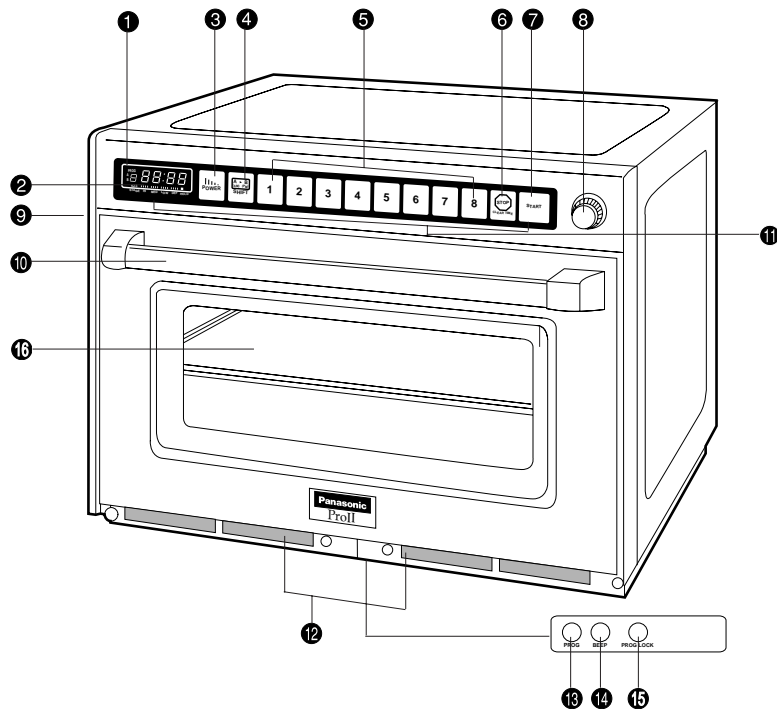

- ① Digital Display Window (see below)
- ② Power Level Indicator Display
- ③ Power Level Selector Pad
- ④ Memory Shift Pad
- ⑤ Memory Pads
- ⑥ Stop/Clear Time Pad
- ⑦ Start Pad
- ⑧ Timer Dial
- ⑨ Oven Lamp Cover
- ⑩ Door Handle
- ⑪ Control Panel
- ⑫ Air Filters
- ⑬ Program Entry Button (behind Air Filters)
- ⑭ Beep Control Button (behind Air Filters)
- ⑮ Program Lock Button (behind Air Filters)
- ⑯ Middle Shelf

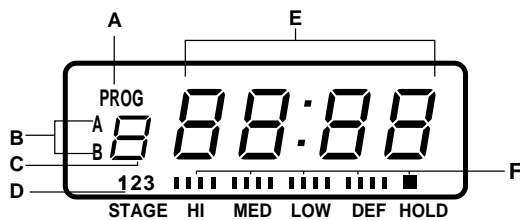

- A - Program Display
- B - Memory Area Code Display
- C - Memory Pad Number Display
- D - Stage Heating Indicator
- E - Heating Time Display (min. sec.)
- F - Power Level Indicator

- HI (HIGH)
- MED (MEDIUM)
- LOW
- DEF (DEFROST)
- HOLD

This oven is preset at the factory for the following:

- ◆ Manual operation
- ◆ Memory pads preset HIGH power at the indicated heating times for single stage heating

1 = 10 sec.	2 = 20 sec.	3 = 30 sec.	4 = 45 sec.	5 = 1 min.
6 = 1 min. 15 sec.	7 = 1 min. 30 sec.	8 = 2 min.		

 (There are two sides, A and B. Only A-side is preset.)
- ◆ Program Unlock
- ◆ Cycle Counter set to "0" on all pads

If you wish to change these times, please consult the operating instructions to find how to program them.

How to Operate

A. MANUAL HEATING

◆ *Single stage heating*

This feature gives the user maximum flexibility to set the oven to desired heating times and power levels. Ideal for menus that require variations in heating requirements.

Example: To cook food at HIGH power for 2 minutes

	PAD	INSTRUCTION	DIGITAL DISPLAY WINDOW
1		Open the door and put the food in the oven. ☛ The oven lamp will turn on and "0" will appear. Note: While "0" appears, operation is available. One minute after the door is closed, "0" will disappear.	
2		Press Power Level Selector pad once. ☛ The selected power level will be indicated and 1st Stage Heating Indicator "1" will start to blink. Note: Press once for HIGH power, twice for MEDIUM power, 3 times for LOW, four times for DEFROST and 5 times for HOLD.	
3		Set the desired heating time using the Timer Dial. ☛ The selected heating time will appear. Note: up to 15 min. on HI or MED, 60 min. on LOW, DEF or HOLD	
4		Press Start pad. ☛ The oven lamp will turn on and heating will start. Power Level Indicator will start to blink, and heating time will count down.	
<ul style="list-style-type: none"> • When all time expires, beep tone will sound and heating will stop. The oven lamp will turn off. "0" will blink until the door is opened. One minute later, cooling fan will stop. • Open the door and take the food out. The oven lamp will turn on. Digital Display Window will show the originally selected time and power. ("REPEAT" feature) • Close the door. The oven lamp will turn off. One minute later, Digital Display Window will go blank. 			

How to Operate

◆ 2 or 3 stage heating

This feature allows you to set to begin heating at one power level then shift automatically to a different power level after designated amount of heating time.

Example: To cook food at HIGH power for 2 minutes and at DEFROST power for 1 minute

	PAD	INSTRUCTION	DIGITAL DISPLAY WINDOW
		Follow steps 1 to 3 on page 7.	
4		Press Power Level Selector pad four times. ☛ The selected power level will be indicated and 2nd Stage Heating Indicator "2" will start to blink.	
5		Set the desired heating time for the second stage using the Timer Dial. ☛ The set heating time will appear. Note: up to 15 min. on HI or MED, 60 min. on LOW, DEF or HOLD	
6		Press Start pad. ☛ The oven lamp will turn on. The total time for both stages will appear and start to count down. 1st Stage Heating Indicator "1" and Power Level Indicator for the first stage heating will start to blink.	
		<ul style="list-style-type: none"> • After the first stage heating, a single beep tone will sound. 2nd Heating Stage Indicator "2" and Power Level Indicator for the second stage heating will start to blink and the remaining heating time will count down. • When all time expires, beep tone will sound and heating will stop. The oven lamp will turn off. "0" will blink until the door is opened. One minute later, cooling fan will stop. • Open the door and take the food out. The oven lamp will turn on. Digital Display Window will show the originally set time and power. ("REPEAT" feature) • Close the door. The oven lamp will turn off. One minute later, Digital Display Window will go blank. 	

Note: For 3 stage Heating, repeat steps 4 and 5 above before pressing Start pad.

SPECIAL NOTE: For both single and 2 or 3 stage heating

1. While heating, pressing Stop/Clear Time pad stops the operation. You can restart it by pressing Start pad. Pressing Stop/Clear Time pad again will cancel the selected program.
2. While not heating, pressing Stop/Clear Time pad cancels the selected program.
3. You can repeat exactly the same manually selected heating time by pressing only Start pad, if you use the oven again within one minute (within 30 minutes when the door has been left open).
4. One minute later of non-use with door closed, the REPEAT feature will be cancelled.

How to Operate

B. PROGRAMMED HEATING

◆ In Program Unlock Mode:

MAKE SURE THE UNIT IS PROGRAMMED TO YOUR SPECIFICATION OR NEEDS(see page 10).

Example: To select Memory pad "5" on the A side in which your desired heating program (at HIGH power for 3 min., single stage heating) is set

	PAD	INSTRUCTION	DIGITAL DISPLAY WINDOW
1		Open the door and put the food in the oven. ⚡ The oven lamp will turn on and "0" will appear. Note: While "0" appears, operation is available. One minute after the door is closed, "0" will disappear.	
2		Press the Desired Memory Pad "5". ⚡ The currently programmed information will be indicated.	
3		Press Start pad. ⚡ The oven lamp will turn on and heating will start. The heating time will count down.	
<ul style="list-style-type: none"> • When all time expires, beep tone will sound and heating will stop. The oven lamp will turn off. "0" will blink until the door is opened. One minute later, cooling fan will stop. • Open the door and take the food out. The oven lamp will turn on. • Close the door. The oven lamp will turn off. One minute later, Digital Display Window will go blank. 			

Note:

- When you want to select Memory Area B, press Memory Shift pad before pressing the desired Memory pad.

◆ In Program Lock Mode:

Just press the desired Memory pad. Heating will automatically start without having to press Start pad.









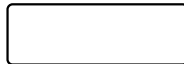

How to Operate

C. PROGRAMMING MEMORY PADS

◆ *Single stage heating*

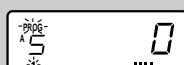
THE OVEN CAN NOT BE PROGRAMMED WHEN PROGRAM LOCK IS ACTIVATED! (see page 11)
DO NOT OPEN THE DOOR WHILE PROGRAMMING!

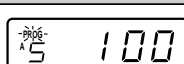
Example: To program cooking on DEFROST power for 1 minute into Memory pad "5"

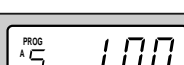
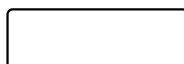
PAD	INSTRUCTION	DIGITAL DISPLAY WINDOW
1	Keep the door closed. ☞ Digital Display Window must be blank or show "0".	
2 	Press Program Entry Button. ☞ "PROG" will start to blink.	
3 	Press Memory pad you wish to program. ☞ The selected pad number will appear and currently programmed information will be indicated.	
4 	Press Power Level Selector pad four times. ☞ The selected power level will be indicated, "PROG" and 1st Stage Heating Indicator "1" will start to blink.	
5 	Set the desired heating time using Timer Dial. ☞ The set heating time will appear. Note: up to 15 min. on HI or MED, 60 min. on LOW, DEF or HOLD	
6 	Press Program Entry Button again. ☞ "PROG" and 1st Stage Heating Indicator "1" will stop blinking. This means that you have completed programming.	
<ul style="list-style-type: none"> • Three seconds later, Digital Display Window will go blank. 		

Note:

- Program the remaining Memory pads as desired by repeating steps 2-6 above.
- When you want to select Memory Area B, press Memory Shift pad  before selecting the desired Memory pad (step 3).

How to Operate

◆ 2 or 3 stage heating

THE OVEN CAN NOT BE PROGRAMMED WHEN PROGRAM LOCK IS ACTIVATED! (see below on this page)
DO NOT OPEN THE DOOR WHILE PROGRAMMING!

Example: To program cooking at DEFROST power for 1 minute and at HIGH power for 2 minutes into Memory pad "5"

PAD	INSTRUCTION	DIGITAL DISPLAY WINDOW
	Follow steps 1 to 5 on page 10.	
6	Press Power Level Selector pad once. ☛ The power level for 2nd stage will be indicated, 2nd Stage Heating Indicator "2" will start to blink.	
7	Set the desired heating time using Timer Dial. ☛ The set heating time will appear. Note: up to 15 min. on HI or MED, 60 min. on LOW, DEF or HOLD	
8	Press Program Entry Button again. ☛ "PROG" and 2nd Stage Heating Indicator "2" will stop blinking. The total time for both stages will appear. This means that you have completed programming.	
<ul style="list-style-type: none"> • Three seconds later, Digital Display Window will go blank. 		

D. PROGRAM LOCK

◆ To activate Program Lock:

PAD	INSTRUCTION	DIGITAL DISPLAY WINDOW
1	Keep the door closed. ☛ Digital Display Window must be blank.	
2	Press Program Lock Button for five seconds until "PROG", "P" and "L" appear. ☛ "PROG", "P" and "L" will appear.	

In Program Lock mode:

- The oven is started by pressing the desired Memory pad. There is no need to press Start pad.
- Opening the door cancels the remaining time on the program.
- The oven can not be programmed until the program lock is released.

◆ To release Program Lock:

PAD	INSTRUCTION	DIGITAL DISPLAY WINDOW
1	Keep the door closed. ☛ Digital Display Window must be blank.	
2	Press Program Lock Button for five seconds until "PROG" and "P" appear. ☛ "PROG" and "P" will appear.	

In Program Unlock mode:







- Oven reverts to a two-touch operating mode (Memory pad + Start pad).
- Repeat and interrupt feature are operational.
- Memory pads can be programmed.
- Tone loudness and length can be changed.

How to Operate



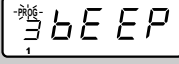

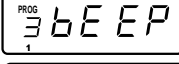
E. BEEP TONE

The loudness of beep tone and its duration at the end of heating cycle can be set. There are four levels of the loudness and two levels of duration. The loudest level and 3 beeps are preset at the factory.



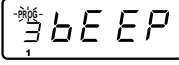

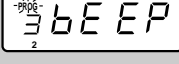

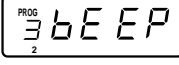
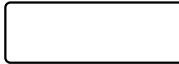
◆ To select loudness level and length “3 beeps”:

	PAD	INSTRUCTION	DIGITAL DISPLAY WINDOW
1		Press Program Entry Button. ☛ “PROG” sign will start to blink in the display window. (The door may be open or closed at this stage.)	
2		Press Beep Control Button. ☛ The tone will sound at its loudest level (level “3”) and the word “bEEP” will appear. “PROG” will start to blink and 1st Stage Heating Indicator “1” (the length of beep tone “3 beeps”) will be indicated. Note: Repeating to press Beep Control Button will lower the loudness level all the way to silent. (3bEEP — loudest, 2bEEP — middle, 1bEEP — quietest, and 0bEEP — silent)	
3		Press Program Entry Button again. ☛ “PROG” will stop blinking. That means that you have completed program. Three seconds later, the display window will go blank when the door is closed.	 

◆ To select length of tone “long beeps for 60 seconds”:

	PAD	INSTRUCTION	DIGITAL DISPLAY WINDOW
3 a		Follow steps 1 to 3 of above.	
4		Within three seconds after pressing Program Entry Button, press Beep Control Button. ☛ “PROG” will start to blink and 2nd Stage Heating Indicator “2” (the length of beep tone “long beeps for 60 seconds”) will be indicated.	
5		Press Program Entry Button again. ☛ “PROG” will stop blinking. This means that you have completed programming. Three seconds later, the display window will go blank when the door is closed.	 

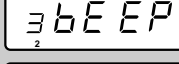
F. PROGRAM LIST

	PAD	INSTRUCTION	DIGITAL DISPLAY WINDOW
1		Open the door and leave it open. ☛ The oven lamp will turn on and “0” will appear.	
2	 + 	While pressing Stop/Clear Time pad, press Start pad. ☛ All currently programmed information (the program set into each Memory pad (A/B sides), Beep Tone, and Program Lock information) will continuously appear.	   

How to Operate

G. CYCLE COUNTER

◆ To Read Total Cumulative Times That The Oven Has Been Used:

	PAD	INSTRUCTION	DIGITAL DISPLAY WINDOW
1		Open the door and leave it open. ☛ The oven lamp will turn on and "0" will appear.	
2		Close the door. ☛ Carry out Step 3 within 60 seconds of closing the door, or the display will go blank.	
3	+	While pressing Beep Control Button, press Program Entry Button. ☛ The display shows the total cumulative number of times the oven has been used.	

Self Diagnostics Failure Code Explanation

This oven monitors its operation and displays a Failure Code in the display window when a problem occurs.

What to do when a failure code appears:

CODE	CAUSE	WHAT TO DO						
F01	<ul style="list-style-type: none"> Overcooked food. Temperature of exhaust air too high. 	<ul style="list-style-type: none"> Unplug the appliance to stop beeping. Wait for appliance to cool down to reset operation. If food ignites, do not open the door. If normal operation does not resume, call the service agent with information of failure code. 						
F03	<ul style="list-style-type: none"> Incoming line voltage too high. <div style="border: 1px solid black; padding: 5px; width: fit-content; margin: 10px auto;"> This oven is designed to operate with 208 or 220-240 Volts AC. </div>	<ul style="list-style-type: none"> Check line voltage and that voltage adjustment is matched. (Refer to page 5 for power source voltage adjustment.) <table style="margin-left: auto; margin-right: auto;"> <tr> <td style="padding-right: 20px;">Line Volt.</td> <td>Connector Color</td> </tr> <tr> <td style="padding-right: 20px;">208 V</td> <td>White</td> </tr> <tr> <td style="padding-right: 20px;">220-240 V</td> <td>Black</td> </tr> </table>	Line Volt.	Connector Color	208 V	White	220-240 V	Black
Line Volt.	Connector Color							
208 V	White							
220-240 V	Black							
F04	<ul style="list-style-type: none"> Incoming voltage too low. 	<ul style="list-style-type: none"> If the line voltage is other than 208 or 220-240 V, consult electrician to check outlet. 						
F05	<ul style="list-style-type: none"> Defective Memory IC. 	<ul style="list-style-type: none"> Unplug the appliance and wait more than 1 minute and reconnect. If normal operation does not resume, call the service agent with information of failure code. 						
F33-34	<ul style="list-style-type: none"> Defective thermistor circuit. 							
F44	<ul style="list-style-type: none"> Defective control panel. 							
F81-F84 F86-F89	<ul style="list-style-type: none"> Defective relay circuit. 							

Note: Above codes shown in the display do not indicate all the possible failures on the unit.

Sanitary Counter Top Seal

When microwave oven is placed on a counter top, its base must be sealed in accordance with N.S.F. Standards as per the following instructions.

1. Microwave oven should be located on a level counter top surface. Complete the electrical connections.
2. Thoroughly clean and sanitize the microwave oven bottom perimeter and the counter top area around the microwave oven perimeter.
3. Remove the Air Filter from the front of the oven before applying silicone.
4. Lay generous bead of silicone seal around the entire perimeter of the base of each microwave oven unit.
5. Smooth the silicone seal into the crevice with finger or tool to provide a cove seal.

Note: DO NOT FORGET to re-install the Air Filter after applying silicone.

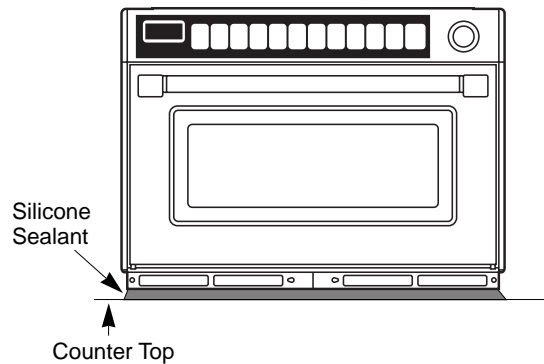

Care of Your Oven

1. Remove the plug from the electrical socket before cleaning.
2. Keep the inside of the oven clean. If pieces of food or spilled liquids stick to the oven walls, or between door seal and door surface, they will absorb microwaves and may cause arcing or sparks. Wipe up all spills with a damp cloth. Kitchen detergent or an approved sanitizing solution may be used if the oven gets very dirty. Do not use harsh detergents or abrasives.
3. The outside surface of this microwave oven should be cleaned with soap and water, then dried. Make sure that water does not get into the back ventilation or control panel opening since this can damage the unit.
4. The window of the door should be washed with very mild soap and water. Be sure to use soft product. Never use window clearer. The front door can be scratched by harsh soap or cleaners.

REPLACEMENT OF THE OVEN LAMP BULB

If the Oven Lamp burns out, it can be replaced by following these directions.

1. Unplug the oven.
2. Unscrew the Oven Lamp Cover which is located on the left side of the cabinet.
3. Replace the old bulb with a new one. (use 230 V - 250 V / 20 W BULB)
4. Reinstall the Oven Lamp Cover.

CAUTION

Remove the plug from the electrical socket before replacement of the Oven Lamp Bulb.

CLEANING THE AIR FILTER

Clean the Air Filters occasionally according to the following instructions. Problems may occur with the oven if the filters become clogged with dirt or dust.*

1. Remove the right Air Filter from the front bottom skirt by pulling the Right Pop Pin straight out. Then slide the filter to the right and lift it off the post at the center. Remove the left Air Filter the same as right one.
2. Wash the filters with soap and water.
3. To replace, align the filter with the center post, and holding the front of the Pop Pin forward, insert the back of the pin into its hole. Press the front of the pin and it will pop into place. Be sure to replace the air filters before using this oven.

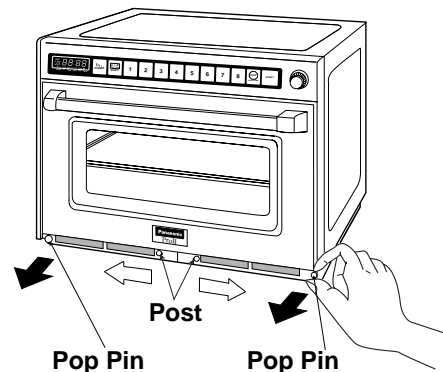

* If the Air Filter becomes clogged with dust or grease this will cause an overheat problem on the oven.

Cooking Instructions

STEAMING BASICS

Fundamental principles determine the success of microwave food preparation.

They include:

1. Always cook or heat foods in covered containers.
- This accomplishes the followings;
a) Retains steam to keep foods moist.
b) Evens cooking temperatures.
c) Keeps the interior of the oven clean.
2. **TEMPERATURE OF FOODS** — Frozen food items will require longer heating times to reach a desired serving temperature than foods that are refrigerated.
3. **FOOD COMPONENTS** — Foods high in sugar, salt, fats and moisture content heat faster because these properties attract microwave energy. Denser foods high in protein and fiber, absorb microwave energy slower which means a lengthier heating time.
4. **BULK/VOLUME** — The greater the mass of food, the longer it takes to heat.
5. **CONTAINERS** — Ceramic, paper, china, styrofoam, glass and plastic are suitable for use in microwave ovens with the following caution.

Heating foods with either high sugar or high fat content should be done **ONLY** in high temperature-resistant containers since these foods get very hot. Using styrofoam containers for these foods will cause the styrofoam to warp. Other low temperature restaurant glass or plastic platters may crack or warp under similar conditions.

- DO NOT HEAT** foods in a **SEALED** container or bag. Foods expand when heated and can break the container or bag.
6. **DO NOT USE METAL** because it “bounces” the microwaves, causing uneven heating and sometimes even flashes, which may pit or mark the interior of the oven, the metal container or plate trim.
 7. Heated liquids can erupt if not mixed with air. Do not heat liquids in your microwave oven without first stirring. (See #1)



GENERAL GUIDELINES FOR STEAMING IN A PANASONIC SONIC STEAMER™

Please refer to the USDA/FDA Food Code guidelines.

STEAMING FOODS FROM REFRIGERATED TEMPERATURE

Foods stored in the refrigerator (40°F) should be covered before reheating with the exception of breads, pastries or any breaded product, which should be heated uncovered to prevent sogginess.

Most conventionally prepared foods should be slightly undercooked, and held in the refrigerator, so that overcooking does not occur during microwave steaming. *

Cooked items, such as vegetables, may be portion plated and covered for reheating without loss of color, texture or nutritional content.

STEAMING FOODS FROM ROOM TEMPERATURE

Food items such as canned entrees, vegetables, etc. will require significantly less steaming time than those from refrigerated temperatures.

IMPORTANT RECOMMENDATIONS

1. For best results it is recommended that foods conventionally prepared be slightly undercooked when subsequently heated in this oven. *
2. **REMEMBER** that after the steaming cycle has been completed, internal food temperatures continue to rise slightly in foods heated in this oven.
3. A major mis-use of microwave applications is the category of breads, pastries and pies. Their crusts and outsides are drier than insides or fillings, they heat more slowly. Therefore, baked goods should **ONLY** be heated until the crust is warm to the touch (120°F-130°F). *
4. **DO NOT OVERHEAT YOUR FOOD: 99% of all food quality complaints of microwave heated foods can be traced to overheating.**

*For only **non** “Potentially Hazardous Foods” (PHF) vegetables, etc. - Please always adhere to USDA/FDA guidelines when cooking and reheating PHF.



Recipes available on www.panasonic.com/cmo (See page 2 for Chef Support)

Technical Specifications

	NE-3280	NE-2180
Power Source	208/230 V, 60 Hz., single phase	
Required Power (Voltage)	28.0 A (208 V) 25.3 A (230 V)	20.0 A (208 V) 18.0 A (230 V)
Receptacle Required	30 AMP NEMA #6-30R	
Output	HI: 3200 W* MED: 1600 W LOW: 340 W DEF: 170 W HOLD: 0 W	HI: 2100 W* MED: 1050 W LOW: 340 W DEF: 170 W HOLD: 0 W
Frequency	2450 MHz	
Outer dimensions (W x D x H)	25 ⁹ / ₁₆ " x 20 ³ / ₄ " x 18 ⁹ / ₁₆ " (650 mm x 526 mm x 471 mm)	
Cavity dimensions (W x D x H)	21 ¹ / ₁₆ " x 13" x 9 ⁷ / ₈ " (535 mm x 330 mm x 250 mm)	
Net weight (approx.)	136.4 lbs. (62 kg)	116.7 lbs. (53 kg)
Timer	Maximum programmable time for single stage heating HI and MED power = 15 min. LOW, DEF and HOLD = 60 min.	
Memory Capability	16 programs	

*IEC 705-88 Test Procedure
Specifications subject to change without notice.

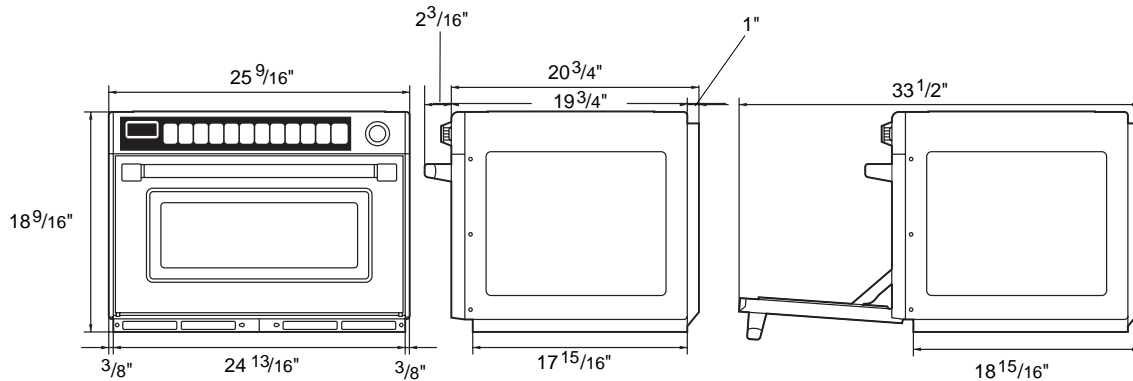

Panasonic®

www.panasonic.com/cmo

PANASONIC HOME AND COMMERCIAL
PRODUCTS COMPANY, DIVISION OF
MATSUSHITA ELECTRIC CORPORATION
OF AMERICA

One Panasonic Way 4A-4
Secaucus, NJ 07094
Or Call (201) 348-5377

A00033A40AP
F0701-0
Printed in Japan