

Operating Instructions LED TV

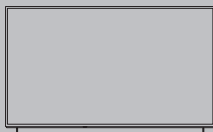

VIERA

For more detailed instructions, please refer to
[eHELP] (Built-in Operating Instructions).

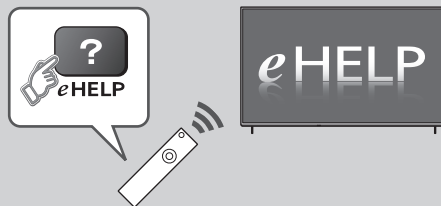

- How to use [eHELP] → (p. 16)

Thank you for purchasing this Panasonic product.

Please read these instructions carefully before operating this product and retain them for future reference.

Please carefully read the "Safety Precautions" of this manual before use.

The images shown in this manual are for illustrative purposes only.



- For information about the trademarks, refer to [eHELP] (Support > Licence).

Contents

Be Sure to Read

Important Notice	3
Safety Precautions	4

Quick Start Guide

Accessories	7
Connections	9
Identifying Controls	12
First time Auto Tuning	15

Using your VIERA

Watching TV	16
How to Use eHELP	16
Viewing 3D images	17

Others

FAQs	18
Maintenance	18
Specifications	19

The illustration for TH-55CX740A is used in this manual unless otherwise mentioned.

Illustrations shown may be different between models and countries.

Important Notice

Panasonic does not guarantee operation and performance of peripheral devices made by other manufacturers; and we disclaim any liability or damage arising from operation and/or performance from usage of such other maker's peripheral devices.

The recording and playback of content on this or any other device may require permission from the owner of the copyright or other such rights in that content. Panasonic has no authority to and does not grant you that permission and explicitly disclaims any right, ability or intention to obtain such permission on your behalf. It is your responsibility to ensure that your use of this or any other device complies with applicable copyright legislation in your country. Please refer to that legislation for more information on the relevant laws and regulations involved or contact the owner of the rights in the content you wish to record or playback.

This product is licensed under the AVC patent portfolio license for the personal and non-commercial use of a consumer to (i) encode video in compliance with the AVC Standard ("AVC Video") and/or (ii) decode AVC Video that was encoded by a consumer engaged in a personal and non-commercial activity and/or was obtained from a video provider licensed to provide AVC Video. No license is granted or shall be implied for any other use.

Additional information may be obtained from MPEG LA, LLC.

See <http://www.mpegla.com>.

Panasonic and its affiliates make no representations or warranties of any kind with respect to the USB devices and the performance of communication between the USB devices and the USB port of Panasonic products, and expressly disclaims any and all warranties, whether express or implied or otherwise, including without limitation any implied warranty of fitness for a particular purpose, any loss of data, and any implied warranties arising from course of dealing or course of performance of data communication between the USB devices and the USB port of Panasonic products.

Transport only in upright position.

Safety Precautions

To help avoid risk of electrical shock, fire, damage or injury, please follow the warnings and cautions below:

■ Mains plug and lead

Warning

If you detect anything unusual, immediately remove the mains plug.



- Mains plug types vary depending on the model.
- This TV is designed to operate on AC 220-240 V, 50 / 60 Hz.
- Insert the mains plug fully into the mains socket.
- Ensure that the mains plug is easily accessible.
- Disconnect the mains plug when cleaning the TV.
- Do not touch the mains plug with wet hands.
- Do not damage the mains lead.
 - Do not place a heavy object on the lead.
 - Do not place the lead near a high temperature object.
 - Do not pull on the lead. Hold onto the mains plug body when disconnecting the plug.
 - Do not move the TV with the lead plugged into a mains socket.
 - Do not twist the lead, bend it excessively or stretch it.
 - Do not use a damaged mains plug or mains socket.
 - Ensure the TV does not crush the mains lead.
- Do not use any mains lead other than that provided with this TV.



■ Take care

Warning

- Do not remove covers and never modify the TV yourself as live parts are accessible when they are removed. There are no user serviceable parts inside.
- Do not expose the TV to rain or excessive moisture. This TV must not be exposed to dripping or splashing water and objects filled with liquid, such as vases, must not be placed on top of or above the TV.
- Do not insert foreign objects into the TV through the air vents.
- Do not use an unapproved pedestal / mounting equipment. Be sure to ask your local Panasonic dealer to perform the setup or installation of approved wall-hanging brackets.
- Do not apply any strong force or impact to the display panel.
- Ensure that children do not climb on the TV.
- Do not place the TV on sloping or unstable surfaces, and ensure that the TV does not hang over the edge of the base.



Important information

If the TV is not positioned in a sufficiently stable location, it can be potentially hazardous due to falling. Many injuries, particularly to children, can be avoided by taking simple precautions such as:

- Using cabinets or stands recommended by the manufacturer of the TV.
 - Only using furniture that can safely support the TV.
 - Ensuring the TV is not overhanging the edge of the supporting furniture.
 - Not placing the TV on tall furniture (for example, cupboards or bookcases) without anchoring both the furniture and the TV to a suitable support.
 - Not standing the TV on cloth or other materials placed between the TV and supporting furniture.
 - Educating children about the dangers of climbing on furniture to reach the TV or its controls.
- This TV is designed for indoor use.
 - This TV is designed for table-top use.
 - Do not expose the TV to direct sunlight and other sources of heat.



To prevent the spread of fire, keep candles or other open flames away from this product at all times



■ Suffocation / Choking Hazard

Warning

- The packaging of this product may cause suffocation, and some of the parts are small and may present a choking hazard to young children. Keep these parts out of reach of young children.
- 3D Eyewear contains small parts that can be swallowed by young children accidentally. Keep these parts out of reach of young children.

■ Pedestal

Warning

- Do not disassemble or modify the pedestal.

Caution

- Do not use any pedestal other than the one provided with this TV.
- Do not use the pedestal if it becomes warped or physically damaged. If this occurs, contact your nearest Panasonic dealer immediately.
- During setup, make sure that all screws are securely tightened.
- Ensure that the TV does not suffer any impact during installation of the pedestal.
- Ensure that children do not climb onto the pedestal.
- Install or remove the TV from the pedestal with at least two people.
- Install or remove the TV according to the specified procedure.

■ Radio waves

Warning

- Do not use the TV, 3D Eyewear and Touch Pad Controller in any medical institutions or locations with medical equipment. Radio waves may interfere with the medical equipment and may cause accidents due to malfunction.
- Do not use the TV, 3D Eyewear and Touch Pad Controller near any automatic control equipment such as automatic doors or fire alarms. Radio waves may interfere with the automatic control equipment and may cause accidents due to malfunction.
- Keep at least 22 cm away from the TV if you have a cardiac pacemaker.
- Do not disassemble or alter the TV, 3D Eyewear and Touch Pad Controller in any way.

■ Built-in wireless LAN

Caution

- Do not use the built-in wireless LAN to connect to any wireless network (SSID*) for which you do not have usage rights. Such networks may be listed as a result of searches. However, using them may be regarded as illegal access.
*SSID is a name for identifying a particular wireless network for transmission.
- Do not subject the built-in wireless LAN to high temperatures, direct sunlight or moisture.
- Data transmitted and received over radio waves may be intercepted and monitored.
- The built-in wireless LAN uses 2.4 GHz and 5 GHz frequency bands. To avoid malfunctions or slow response caused by radio wave interference when using the built-in wireless LAN, keep the TV away from other devices that use 2.4 GHz and 5 GHz signals such as other wireless LAN devices, microwave ovens, and mobile phones.
- When problems occur due to static electricity, etc., the TV might stop operating to protect itself. In this case, turn the TV off at the Mains power On / Off switch, then turn it back on.
- Additional information for the wireless LAN and access point may be on the following website.
<http://panasonic.net/viera/support>

■ Bluetooth® wireless technology

Caution

- The TV, 3D Eyewear and Touch Pad Controller use the 2.4 GHz radio frequency ISM band (Bluetooth®). To avoid malfunctions or slow response caused by radio wave interference, keep the TV, 3D Eyewear and Touch Pad Controller away from the devices such as other wireless LAN devices, other Bluetooth devices, microwaves, mobile phones and the devices that use 2.4 GHz signal.

■ Ventilation

Caution

Allow sufficient space around the TV in order to help prevent excessive heat, which could lead to early failure of some electronic components.

Minimum distance:

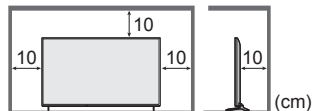

- Ventilation should not be impeded by covering the ventilation openings with items such as newspapers, tablecloths and curtains.



- Whether you are using a pedestal or not, always ensure the vents at the bottom of the TV are not blocked and there is sufficient space to enable adequate ventilation.

■ Moving the TV

Caution

Before moving the TV, disconnect all cables.

- Move the TV with at least two people.

■ When not in use for a long time

Caution

This TV will still consume some power even in the Off mode, as long as the mains plug is still connected to a live mains socket.

- Remove the mains plug from the wall socket when the TV is not in use for a prolonged period of time.

■ Battery for the Remote Control / 3D Eyewear / Touch Pad Controller

Caution

- Incorrect installation may cause battery leakage, corrosion and explosion.
- Replace only with the same or equivalent type.
- Do not mix old and new batteries.
- Do not mix different battery types (such as alkaline and manganese batteries).
- Do not use rechargeable batteries (Ni-Cd, etc.).
- Do not burn or break up batteries.
- Do not expose batteries to excessive heat such as sunshine, fire or the like.
- Make sure you dispose of batteries correctly.
- Remove the battery from the unit when not using for a prolonged period of time to prevent battery leakage, corrosion and explosion.

■ 3D Eyewear Use

Caution

- Use the 3D Eyewear only for the intended purpose and nothing else.
- Do not move around while wearing the 3D Eyewear to avoid falling or accidental injury.
- Do not drop, bend, apply pressure on, or step on the 3D Eyewear.
- Be careful of the tips of the frame when putting on the 3D Eyewear.
- Be careful not to trap your fingers in the hinge section of the 3D Eyewear.
- Do not use the 3D Eyewear if it is physically damaged.
- If you suffer from any eyesight problems (short / far-sighted, astigmatism, eyesight differences in left and right), ensure that you correct your vision before using the 3D Eyewear. The supplied 3D Eyewear can be worn over vision correction glasses.
- Stop using the 3D Eyewear immediately if you experience any redness, pain or skin irritation around the nose or temples. In rare cases, the materials used in the 3D Eyewear may cause an allergic reaction.
- Do not use the 3D Eyewear at high temperatures. Always keep the 3D Eyewear in a cool and dry place.
- Stop using the 3D Eyewear immediately if a malfunction or fault occurs.

■ Viewing 3D Images

Caution

- Pay special attention when children are viewing 3D images. 3D images should not be viewed by children younger than about 6 years old, as a guideline. All children must be fully supervised by parents or guardians who must ensure their safety and health while they are viewing 3D images.
- Stop viewing 3D images immediately if you feel tired, feel unwell, experience any other uncomfortable sensation or clearly see double images. Take an appropriate break before continuing to view. When you set the 3D effect by using [3D Adjustment], take into account that the vision of 3D images varies among different individuals.
- Do not view 3D images if you have a history of oversensitivity to light, heart problems or any other medical conditions.
- When viewing 3D images, your sense of distance may be tricked or go wrong. Be careful not to hit the TV screen or other people unintentionally. Ensure there are no breakable objects around you to avoid any accidental damage or injury.
- The recommended viewing distance is at least 3 times of the image height. Do not view 3D images from a distance shorter than recommended.

Accessories

Remote Control

➔ (p. 12)

- N2QAYB001008



Touch Pad Controller

➔ (p. 13)

- N2QBAYA000016



Pedestal (2)

➔ (p. 7)

- R
- L

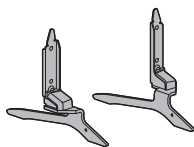

Mains lead

➔ (p. 9)

50-inch model



55-inch model

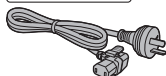

Batteries

- R6 (2)
(For Remote Control)

➔ (p. 13)

- R03 (2)
(For Touch Pad Controller)

➔ (p. 14)



3D Eyewear

➔ (p. 17)



Operating Instructions with Warranty statement

Fall-prevention parts

➔ (p. 8)

- Accessories may not be placed all together. Take care not to throw them away unintentionally.
- For information about the optional accessories, refer to [eHELP] (Support > Optional accessories).

Assembling / Removing the pedestal

A Assembly screw (4)



M4 × 12

B Pedestal (R)

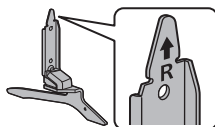

C Pedestal (L)

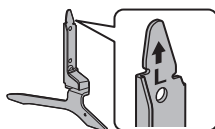

■ Preparations

Take out the pedestal and the TV from the packing case and put the TV onto a work table with the screen panel down on the clean and soft cloth (blanket, etc.)

- Use a flat and firm table bigger than the TV.
- Do not hold the screen panel part.
- Make sure not to scratch or break the TV.

■ Assembling the pedestal

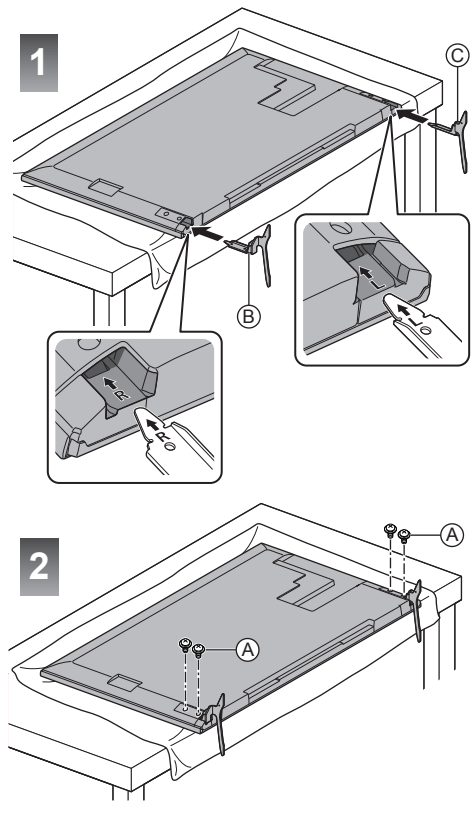

■ Preventing the TV from falling over

It is recommended to secure the pedestal to a furniture as shown to prevent the TV from falling over.

- This information is designed to reduce the risk of injuries caused by the TV falling over. However, no measure can guarantee protection in all cases.

ⓓ Band (2)

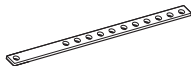

ⓔ Screw (2)



ⓕ Wood screw (2)

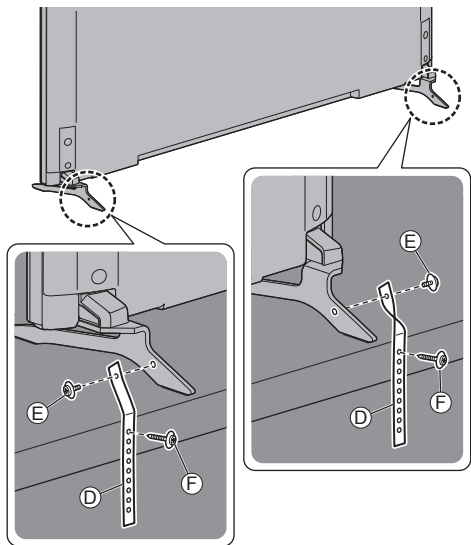

Removing the pedestal from the TV

Be sure to remove the pedestal in the following way when using the wall-hanging bracket or repacking the TV.

- 1 Put the TV onto a work table with the screen panel down on the clean and soft cloth.
- 2 Remove the assembly screws (A) from the TV.
- 3 Pull out the pedestal from the TV.

Connections

- External equipment and cables shown are not supplied with this TV.
- Please ensure that the unit is disconnected from the mains socket before attaching or disconnecting any cables.
- Check the terminal type and cable plugs are correct for connection.
- Use a fully wired HDMI compliant cable.
- Keep the TV away from electronic equipment (video equipment, etc.) or equipment with an infrared sensor, otherwise distortion of image / sound may occur or operation of other equipment may be affected.
- Please also read the manual of the equipment being connected.

Terminals

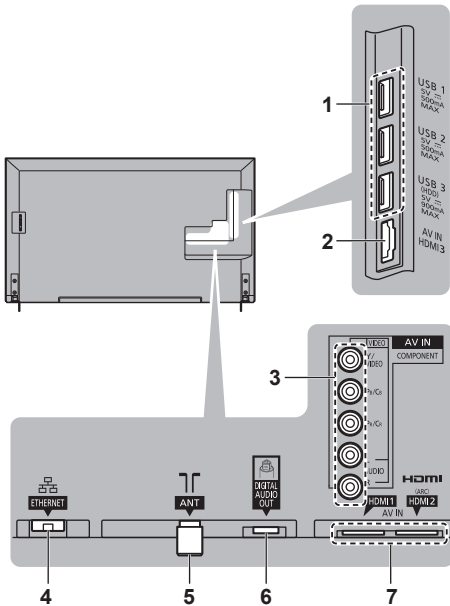

- 1 USB 1 - 3 port
 - 2 HDMI3
 - 3 AV IN (COMPONENT / VIDEO) ➔ (p. 11)
 - 4 ETHERNET ➔ (p. 10)
 - 5 Aerial terminal ➔ (p. 10)
 - 6 DIGITAL AUDIO OUT
 - 7 HDMI1 - 2 ➔ (p. 10, 11)
- To watch content in 4K format, use HDMI terminal. ➔ (p. 10)

Basic connections

■ Mains lead

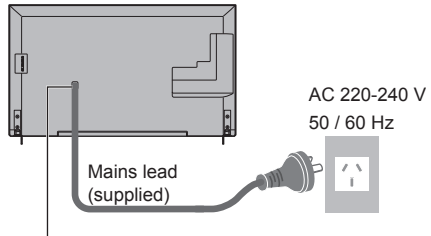

50-inch model

Insert the mains plug firmly into place.



- When disconnecting the mains lead, be absolutely sure to disconnect the mains plug from the mains socket first.

55-inch model

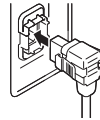

Push until both side tabs click

Make sure that the mains lead is securely fixed

To remove from the TV:

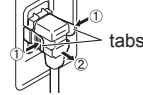

Press both tabs and pull on mains connector to release

■ Aerial

TV

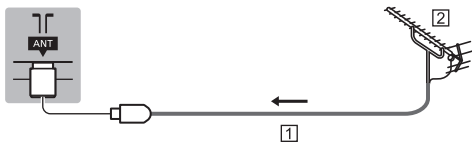

1 RF cable

2 Aerial

- For Digital TV, Analogue TV
- Keep RF (aerial) cable away from the mains lead to avoid and minimise mains interference pickup.
- Do not place the RF cable under the TV.
- An aerial, correct cable (75 Ω coaxial) and correct terminating plug are required to obtain optimum quality picture and sound.
- If a communal aerial system is used, you may require the correct connection cable and plug between the wall aerial socket and the TV.
- Your local Television Service Centre or dealer may be able to assist you in obtaining the correct aerial system for your particular area and the accessories required.
- Any matters regarding aerial installation, upgrading of existing systems or accessories required, and the costs incurred, are the responsibility of you, the customer.

AV devices

■ DVD Recorder / VCR

TV

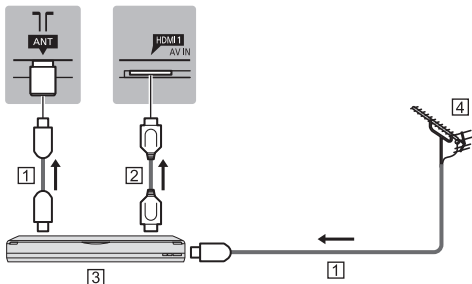

1 RF cable

2 HDMI cable

3 DVD Recorder / VCR

4 Aerial

■ Set top box

TV

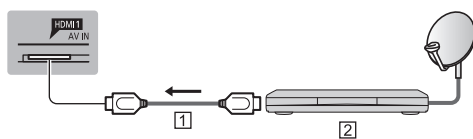

1 HDMI cable

2 Set top box

Network

A broadband network environment is required to be able to use internet services.

- If you do not have any broadband network services, please consult your retailer for assistance.
- Prepare the internet environment for wired connection or wireless connection.
- Setup of the network connection will start when first using the TV. ➔ (p. 15)

■ Wired connection

TV

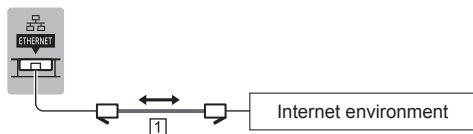

1 LAN cable (Shielded)

- Use Shielded Twist Pair (STP) LAN cable.

■ Wireless connection



1 Built-in wireless LAN

2 Access point

Connections for 4K compatible equipment

TV

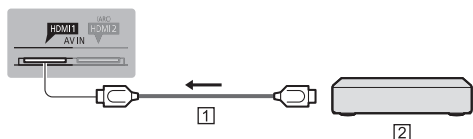

1 HDMI cable

2 4K compatible equipment

- Connect the 4K compatible equipment to HDMI terminal and you can watch contents of 4K format.
- When connecting to HDMI terminal, use a 4K compatible cable.

Other connections

■ DVD Player

(COMPONENT equipment)

TV

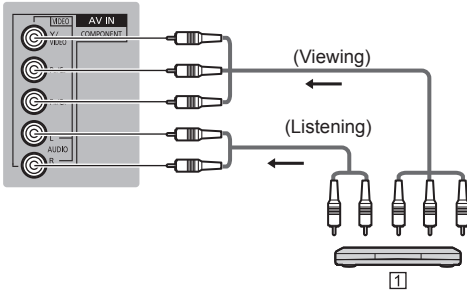

1 DVD Player

■ Camcorder / Game equipment

(VIDEO equipment)

TV

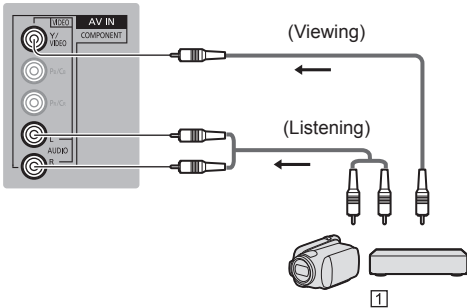

1 Camcorder / Game equipment

■ Blu-ray Disc Player

(3D-compatible equipment)

TV

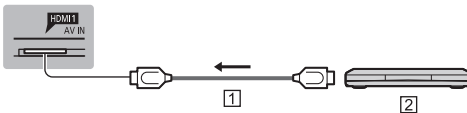

1 HDMI cable

2 Blu-ray Disc Player

■ Amplifier (listening with external speakers)

- Use HDMI2 to connect the TV to an amplifier which has ARC (Audio Return Channel) function.
If connecting to an amplifier without ARC function, use DIGITAL AUDIO OUT.
- To enjoy multi-channel sound from external equipment (e.g. Dolby Digital 5.1ch), connect the equipment to the amplifier. For information about the connections, read the manuals of the equipment and amplifier.

TV

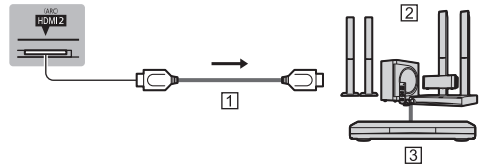

1 HDMI cable

2 Amplifier with speaker system

3 External equipment (DVD Player, etc.)

■ USB HDD (for recording)

- Use USB 3 for connecting the USB HDD.
- For details, refer to [eHELP] (Recording).

■ VIERA Link

- Use HDMI1 - 3 for VIERA Link connection.
- For details, refer to [eHELP] (Functions > VIERA Link "HDAVI Control™").

Identifying Controls

Remote Control

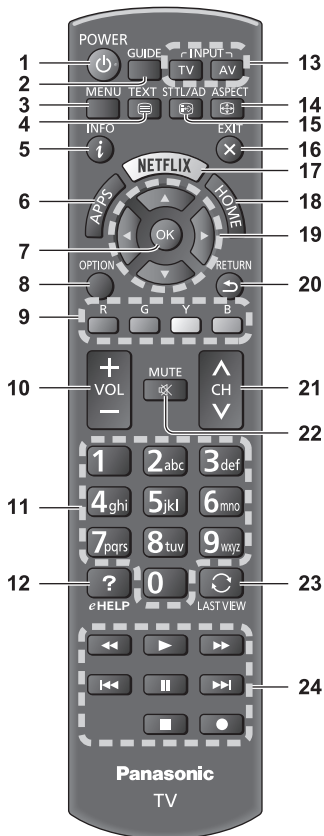

1 Standby On / Off switch

2 TV Guide

3 [Main Menu]

- Press to access Picture, Sound, Network, Timer, Setup and Help Menus, etc.

4 Teletext button

- This button is not used for this model.

5 Information

- Displays channel and programme information.

6 APPS

- Displays [APPS List] (applications list).

7 OK

- Confirms selections and choices.
- Press after selecting channel positions to quickly change channel.
- Displays channel list.

8 [Option Menu]

- Easy optional setting for viewing, sound, etc.

9 Coloured buttons

(red-green-yellow-blue)

- Used for the selection, navigation and operation of various functions.

10 Volume Up / Down

11 Numeric buttons

- Changes channel.
- Sets characters.
- When in Standby mode, switches TV on.

12 [eHELP]

- Displays [eHELP] (Built-in Operating Instructions).

13 Input mode selection

- TV - switches to Digital TV / Analogue TV.
- AV - switches to AV input mode from Input Selection list.

14 Aspect

- Changes aspect ratio.

15 Subtitle / Audio Description

- Displays [Audio Description / Subtitle Menu].

16 Exit

- Returns to the normal viewing screen.

17 Netflix

- Accesses NETFLIX service directly.
- A broadband network environment is required to be able to use this function fully.
- This service may be stopped or changed without notice.

18 HOME

- Displays Home screen.
- For details, refer to [eHELP] (Read first > Features).

19 Cursor buttons

- Makes selections and adjustments.

20 Return

- Returns to the previous menu / page.

21 Channel Up / Down

22 Sound Mute On / Off

23 Last view

- Switches to previously viewed channel or input mode.

24 Operations for contents, connected equipment, etc.

■ Installing / Removing batteries

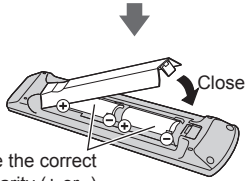
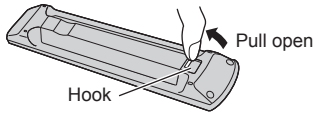

Note the correct polarity (+ or -)

Touch Pad Controller

Touch Pad Controller is designed for the convenient operations, especially, on Home screen or internet content. You can operate the TV intuitively with this controller.

- Touch Pad Controller can be used exclusively for controlling this TV.
- Register the Touch Pad Controller to this TV with Bluetooth wireless technology before using.
The registration starts automatically when you press any buttons (except Standby On / Off switch) after installing batteries.
- After registering, you can operate the TV without pointing this controller at the TV (except Standby On / Off switch).
- To use Standby On / Off switch, point the controller directly at the TV's remote control signal receiver because it works with the infrared sensors. (You can operate the switch without registration.)
- It is recommended to speak within approx. 15 cm from the microphone of Touch Pad Controller when using the Voice Control function.
- For details, refer to [eHELP] (Functions > Touch Pad Controller).

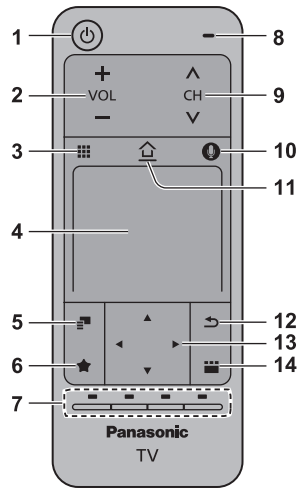

1 Standby On / Off switch

2 Volume Up / Down

3 On-screen remote control

- Press to display the remote control GUI (Graphical User Interface).

4 Touch pad

- For information about the operation, refer to [Operation Guide] in [VIERA Touch Pad Controller] (Setup Menu).

5 [Option Menu]

6 Registers a shortcut on Home screen

7 Coloured buttons

(red-green-yellow-blue)

- Used for the selection, navigation and operation of various functions.

8 Microphone

9 Channel Up / Down

10 Voice Control button

- Press to use Voice Control function.

11 HOME

- Displays Home screen.
- For details, refer to [eHELP] (Read first > Features).

12 Return

- Returns to the previous menu / page.

13 Cursor buttons

- Makes selections and adjustments.

14 APPS

- Displays applications list.

■ Installing / Removing batteries

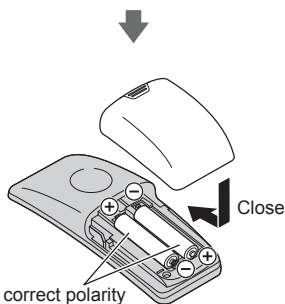
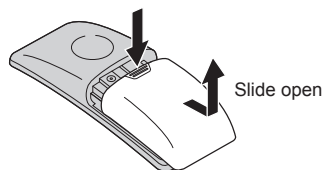

Note

- It is recommended to hold Touch Pad Controller with your hand when using.
- The battery power will be used whenever you use Touch Pad Controller (including the touch of the touch pad) even if not operating the TV. It may decrease the battery life.
- Some operations differ depending on the application.

Indicator / Control panel

- When pressing 4, 5, 6 buttons, the control panel guide appears on the right side of the screen for 3 seconds to highlight which button has been pressed.

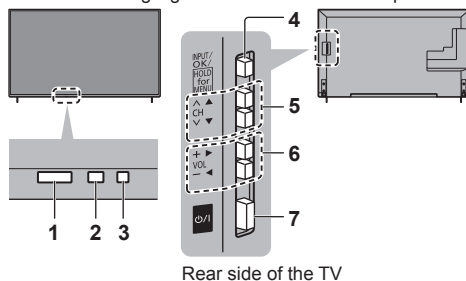

1 Remote control signal receiver

- Do not place any objects between the TV remote control signal receiver and remote control.

2 Ambient sensor

- Senses brightness to adjust picture quality when [Ambient Sensor] in the Picture Menu is set to [On].

3 Power LED

Red: Standby

Green: On

Orange: Standby with some functions (recording, etc.) active

- The LED blinks when the TV receives a command from the remote control.

4 Input mode selection

- Press repeatedly until you reach the desired mode.

[Main Menu]

- Press and hold for about 3 seconds to display main menu.

OK (when in the menu system)

5 Channel Up / Down

- Cursor Up / Down (when in the menu system)

6 Volume Up / Down

- Cursor Left / Right (when in the menu system)

7 Mains power On / Off switch

- Use to switch the mains power.

First time Auto Tuning

When the TV is turned on for the first time, it will automatically search for available TV channels and give options to set up the TV.

- These steps are not necessary if the setup has been completed by your local dealer.
- Please complete connections (p. 9 - 11) and settings (if necessary) of the connected equipment before starting Auto Tuning. For information about the settings for the connected equipment, read the manual of the equipment.

1 Plug the TV into a live mains socket and turn the power on

POWER • Takes a few seconds to be displayed.



2 Select the following items

Set up each item by following the on-screen instructions.

Example:



■ How to use the remote control



Move the cursor



Access the item / store the setting

RETURN



Return to the previous item (if available)

Select the language

Select [Home]

Select [Home] for use in a home viewing environment.

- [Shop] is for shop display.
- To change the viewing environment later on, the set will need to have all settings initialised by accessing Shipping Condition.

Select up the network connection

Select your area

Tick the TV signal mode to tune, and then select [Start Auto Tuning]

: tune (search for the available channels)

: skip tuning

Auto Tuning is now complete and the TV is ready for viewing.

If tuning has failed check the Satellite cable, RF cable, and the network connection, and then follow the on-screen instructions.

Note

- The TV goes into Standby mode when no operation is performed for 4 hours if [Auto Standby] in the Timer Menu is set to [On].
- The TV goes into Standby mode when no signal is received and no operation is performed for 10 minutes if [No signal Power off] in the Timer Menu is set to [On].
- To retune all channels
 - ➔ [Auto Tuning] in [Tuning Menu] (Setup Menu)
- To add the available TV signal mode later
 - ➔ [Add TV Signal] in [Tuning Menu] (Setup Menu)
- To initialise all settings
 - ➔ [Shipping Condition] in [System Menu] (Setup Menu)

Watching TV

1 Turn power on

 (TV)

or
POWER

 (Remote Control)

- Mains power On / Off switch should be on. (p. 14)

Displays information bar on the edge of screen for several seconds.

- For information about the operation and settings, refer to [eHELP]. (Read first > Features)

2 Select the mode

- Selectable modes vary depending on the stored channels and selected country.



3 Select a channel

 up
down

or



- To select a channel position with 2 or more-digit, e.g. 399



How to Use eHELP

[eHELP] is the detailed operating instructions built into the TV, and gives a more detailed explanation for a better understanding of the operation of each feature.

1 Display [eHELP]

eHELP

or

MENU  [Help]  [eHELP]

- If the [eHELP] has been accessed previously since the TV was turned on, the confirmation screen is displayed to select whether to go to the [First page] or to the [Last viewed page].

2 Select the category and item

Category field

Item field



① select category
② access

③ select item
④ access

Sub item field

Description



⑤ select sub item
⑥ access

- To return to the previous field



- To scroll the description (if more than 1 page)
While the description is highlighted



- To display the menu related to the description (only for some descriptions)

R
 (red)

- To check the features of this TV
Read first > Features

Viewing 3D images

You can enjoy viewing 3D images with contents or programmes corresponding to the 3D effect by wearing the 3D Eyewear (supplied).

- The 3D Eyewear must be worn to view 3D images.
- This TV supports [Frame Sequential]*, [Side by Side] and [Top and Bottom] 3D formats. (3D content of 4K format is not supported.)
- For details, refer to [eHELP] (Watching > 3D).

*: Frame Sequential is the 3D format that the images for right and left eyes are recorded with high definition quality and alternately played back.

3D Eyewear

- Use Panasonic 3D Eyewear supporting Bluetooth wireless technology for active shutter 3D.

Note

- Do not apply pressure on or scratch the lens of the 3D Eyewear.
- Do not use devices such as mobile phones or personal transceivers that emit strong electromagnetic waves near the 3D Eyewear as this may cause the 3D Eyewear to malfunction.
- Do not wear the 3D Eyewear when watching anything other than 3D images. Liquid crystal displays (such as computer screens, digital clocks or calculators, etc.) may be difficult to see while wearing the 3D Eyewear.

First registration

Perform the first registration when first using the 3D Eyewear with this TV.

1 Turn the TV on

2 Press Power button for about 1 second to turn the 3D Eyewear on

- The lamp lights for about 2 seconds and then flashes.
- The 3D Eyewear will be turned on and start registration.
- Place the 3D Eyewear within 50 cm from the TV while registration in progress.

3 After the registration is successfully completed, the 3D Eyewear will reconnect with TV automatically when the 3D Eyewear is turned on near the TV in 3D mode

Registration again

When connection with the registered TV fails, or when using with another TV, re-register the 3D Eyewear.

1 Turn the TV on

2 Within 50 cm from the TV, press Power button until lamp lights, then release it to start registration

3 After the registration is successfully completed, the 3D Eyewear will reconnect with TV automatically when the 3D Eyewear is turned on near the TV in 3D mode

To view the 3D images

■ Playing back 3D-compatible Blu-ray disc (Frame Sequential format)

- Connect the 3D-compatible player via a fully wired HDMI compliant cable. (If you use the non 3D-compatible player, the images will be displayed in 2D mode.)
- If the input mode is not switched automatically, select the input mode connected to the player using the AV button.

■ 3D-supported broadcast

- Please consult the suppliers of content or programmes for availability of this service.

■ 3D photos and 3D videos taken by 3D-compatible Panasonic products

- Available in Media Player and Network services.

■ 2D images converted to 3D

- Set to [2D→3D] mode in [3D Mode Selection] ([Picture] > [3D Settings] > [3D Mode]). (Contents of 4K format cannot be changed to 3D mode.)

Preparations

Ensure that the registration of the 3D Eyewear has been completed.

1 Turn the 3D Eyewear on and put it on

Connection status and battery status are displayed on the bottom right of the screen.

2 View the 3D images

Safety precautions will be displayed when you first watch the 3D image. Select [Yes] or [No] to continue to view 3D images.

Note

- Turn off the 3D Eyewear after using it.
- Use the 3D Eyewear within approximately 3.2 m from the TV. You cannot view the 3D images with the 3D Eyewear too far from the TV, because of the difficulty of receiving radio waves from the TV.
- The range may be shortened depending on the obstacles between the TV and the 3D Eyewear, or the surrounding environment.
- Use the 3D Eyewear where there is no interference from other Bluetooth devices.
- 3D content will not be correctly visible if the 3D Eyewear is worn upside down or back-to-front.
- When viewing 3D images, make sure your eyes are in a horizontal position where double vision does not occur.
- If the room is lit by fluorescent lights (50 Hz) and light appears to flicker when using the 3D Eyewear, switch off the fluorescent light.
- There are differences in the viewing range of the 3D Eyewear among individuals.

FAQs

Before requesting service or assistance, please follow these simple guides to solve the problem.

- For details, refer to [eHELP] (Support > FAQs).

The TV does not switch on

- Check the mains lead is plugged into the TV and the mains socket.

The TV goes into Standby mode

- Auto power standby function is activated.

The remote control does not work or is intermittent

- Are the batteries installed correctly? ➔ (p. 13)
- Has the TV been switched on?
- The batteries may be running low. Replace them with new ones.
- Point the remote control directly at the TV's remote control signal receiver (within about 7 m and a 30 degree angle of the signal receiver).
- Situate the TV away from sunshine or other sources of bright light so they do not shine on the TV's remote control signal receiver.

No image is displayed

- Check the TV is turned on.
- Check the mains lead is plugged into the TV and the mains socket.
- Check the correct input mode is selected.
- Check the setting of [AV] ([COMPONENT] / [VIDEO]) in [Input Selection] to match the signal being output by the external equipment.
- Is [Backlight], [Contrast], [Brightness] or [Colour] in the Picture Menu set to the minimum?
- Check all required cables and connections are firmly in place.

An unusual image is displayed

- This TV has a built-in Self Test. Makes a diagnosis of picture or sound problems.
➔ [TV Self Test] (Help Menu)
- Turn the TV off with Mains power On / Off switch, then turn it on again.
- If the problem persists, initialise all settings.
➔ [Shipping Condition] in [System Menu] (Setup Menu)

Parts of the TV become hot

- Parts of the TV may become hot. These temperature rises do not pose any problems in terms of performance or quality.

When pushed with a finger, the display panel moves slightly and makes a noise

- There is a little gap around the panel to prevent damage to the panel. This is not a malfunction.

Maintenance

First, remove the mains plug from the mains socket.

Display panel, Cabinet, Pedestal

Regular care:

Gently wipe the surface of the display panel, cabinet, or pedestal by using a soft cloth to remove dirt or fingerprints.

For stubborn dirt:

- (1) First clean the dust from the surface.
- (2) Dampen a soft cloth with clean water or diluted neutral detergent (1 part detergent to 100 parts water).
- (3) Wring out the cloth firmly. (Please note, do not let liquid enter the TV inside as it may lead to product failure.)
- (4) Carefully wipe moisten and wipe away the stubborn dirt.
- (5) Finally, wipe away all the moisture.

Caution

- Do not use a hard cloth or rub the surface too hard, otherwise this may cause scratches on the surface.
- Take care not to subject the surfaces to insect repellent, solvent, thinner or other volatile substances. This may degrade surface quality or cause peeling of the paint.
- The surface of the display panel is specially treated and may be easily damaged. Take care not to tap or scratch the surface with your fingernail or other hard objects.
- Do not allow the cabinet and pedestal to make contact with a rubber or PVC substance for a long time. This may degrade surface quality.

Mains plug

Wipe the mains plug with a dry cloth at regular intervals. Moisture and dust may cause fire or electrical shock.

Specifications

■ TV

Model No.

50-inch model : TH-50CX740A

55-inch model : TH-55CX740A

Dimensions (W × H × D)

50-inch model

1 121 mm × 695 mm × 242 mm (With Pedestal)

1 121 mm × 650 mm × 46 mm (TV only)

55-inch model

1 237 mm × 762 mm × 242 mm (With Pedestal)

1 237 mm × 717 mm × 54 mm (TV only)

Mass

50-inch model

18.5 kg Net (With Pedestal)

17.5 kg Net (TV only)

55-inch model

21.5 kg Net (With Pedestal)

20.5 kg Net (TV only)

Power Rating

50-inch model

AC 220-240 V, 50 / 60 Hz 0.76 A

55-inch model

AC 220-240 V, 50 / 60 Hz 1.01 A

Normal (Home) mode

50-inch model

87 W

55-inch model

122 W

Standby power consumption

0.50 W

Visible screen size (diagonal)

50-inch model

126 cm

55-inch model

139 cm

Display resolution

3 840 (W) × 2 160 (H)

Panel

LED backlight Liquid Crystal Display

Speaker output

20 W (10 W + 10 W)

Connection terminals

AV IN (COMPONENT / VIDEO)

VIDEO

RCA PIN Type × 1

1.0 V[p-p] (75 Ω)

AUDIO L - R

RCA PIN Type × 2

0.5 V[rms]

Y

1.0 V[p-p] (including synchronisation)

PB/CB, PR/CR

±0.35 V[p-p]

HDMI 1 / 2 / 3 input

TYPE A Connectors

HDMI1 / 3: 4K, 3D (3D content of 4K format is not supported.), Content Type, Deep Colour, x.v.Colour™

HDMI2: 4K, 3D (3D content of 4K format is not supported.), Content Type, Audio Return Channel, Deep Colour, x.v.Colour™

- This TV supports "HDAVI Control 5" function.

ETHERNET

10BASE-T / 100BASE-TX

USB 1 / 2 / 3

USB1 / 2: DC 5 V, Max. 500 mA [Hi-Speed USB (USB 2.0)]

USB3: DC 5 V, Max. 900 mA [SuperSpeed USB (USB 3.0)]

DIGITAL AUDIO OUT

PCM / Dolby Digital / DTS, Fibre optic

Receiving systems / Band name

Digital TV

7 MHz VHF / UHF (Australia) free-to-air TV broadcast reception

PAL B / G

Reception of Off air broadcast

PAL 60 Hz

Playback of NTSC tape from some PAL Video recorders (VCR)

M.NTSC

Playback from M.NTSC Video recorders (VCR)

NTSC

Playback from NTSC Video recorders (VCR)

Aerial input

Standard Belling & Lee connector
VHF / UHF

Operating conditions

Temperature

0 °C - 35 °C

Humidity

20 % - 80 % RH (non-condensing)

Built-in wireless LAN

Standard compliance and Frequency range*1

IEEE802.11a/n

5.15 GHz - 5.35 GHz, 5.47 GHz - 5.85 GHz

IEEE802.11b/g/n

2.400 GHz - 2.4835 GHz

Security

WPA2-PSK (TKIP/AES)

WPA-PSK (TKIP/AES)

WEP (64 bit/128 bit)

Bluetooth wireless technology*2

Standard Compliance

Bluetooth 3.0

Frequency Range

2.402 GHz - 2.480 GHz

*1: The frequency and channel differ depending on the country.

*2: Not all the Bluetooth compatible devices are available with this TV. Up to 5 devices can be used simultaneously (except the 3D Eyewear and Touch Pad Controller).

■ 3D Eyewear

Dimensions (W × H × D)

164.7 mm × 41.0 mm × 170.7 mm

Mass

Approx. 34 g

Usage temperature range

0 °C - 40 °C

Battery

Coin-shaped lithium battery CR2025

Operation time

Approx. 75 hours in continuous use of the battery made by Panasonic

Materials

Main body

Resin

Lens section

Liquid crystal glass

Note

- 3D Eyewear and Touch Pad Controller use Bluetooth wireless technology.
- Design and Specifications are subject to change without notice. Mass and Dimensions shown are approximate.
- For information about the open source software, refer to [eHELP] (Support > Licence).

■ When using the wall-hanging bracket

- Choosing to wall mount the TV shall be done at the owner's risk. Always use a qualified installer to perform a TV wall bracket installation. Incorrect fitting may cause equipment to fall, resulting in injury and product damage. Any such damage will void your warranty.

Holes for wall-hanging bracket installation

Rear of the TV

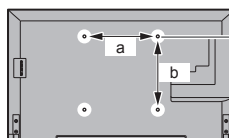

a: 400 mm

b: 400 mm

(View from the side)

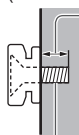

Depth of screw

50-inch model

minimum: 9 mm

maximum: 26 mm

55-inch model

minimum: 10 mm

maximum: 16 mm

Type of screw: M6

Screw for fixing the TV onto the wall-hanging bracket (not supplied with the TV)

Panasonic Warranty

1. The product is warranted for 12 months from the date of purchase. Subject to the conditions of this warranty Panasonic or its Authorised Service Centre will perform necessary service on the product without charge for parts or labour, if in the opinion of Panasonic, the product is found to be faulty within the warranty period.
2. This warranty only applies to Panasonic products purchased in Australia and sold by Panasonic Australia or its Authorised Distributors or Dealers and only where the products are used and serviced within Australia or its territories. Warranty cover only applies to service carried out by a Panasonic Authorised Service Centre and only if valid proof of purchase is presented when warranty service is requested.
3. This warranty only applies if the product has been installed and used in accordance with the manufacturer's recommendations (as noted in the operating instructions) under normal use and reasonable care (in the opinion of Panasonic). The warranty covers normal domestic use only and does not cover damage, malfunction or failure resulting from use of incorrect voltages, incorrect installation, accident, misuse, neglect, build-up of dirt or dust, abuse, maladjustment of customer controls, mains supply problems, thunderstorm activity, infestation by insects or vermin, tampering or repair by unauthorised persons (including unauthorised alterations), introduction of sand, humidity or liquids, commercial use such as hotel, office, restaurant, or other business or rental use of the product, exposure to abnormally corrosive conditions or any foreign object or matter having entered the product.
4. This warranty does not cover the following items unless the fault or defect existed at the time of purchase:
 - (a) Cabinet Part(s)
 - (b) Video or Audio Tapes
 - (c) SD cards or USB devices
 - (d) User replaceable Batteries
 - (e) DVD, Blu-ray, or Recordable Discs
 - (f) Video / Audio Heads from wear and tear in normal use
 - (g) Information stored on Hard Disk Drive, USB stick or SD card
 - (h) DTV reception issues caused by TV Aerial / Cabling / Wall socket(s)
5. Some products may be supplied with Ethernet connection hardware. The warranty is limited on such products and will not cover
 - (a) Internet and or DLNA connection / setup related problems
 - (b) Access fees and or charges incurred for internet connection
 - (c) The use of incompatible software or software not specifically stipulated in the product operations manual; and
 - (d) Any indirect or consequential costs associated with the incorrect use or misuse of the hardware, its connection to the internet or any other device.
6. To claim warranty service, when required, you should:
 - Telephone Panasonic's Customer Care Centre on 132600 or visit our website referred to below and use the Service Centre Locator for the name/address of the nearest Authorised Service Centre.
 - Send or take the product to a Panasonic Authorised Service Centre together with your proof of purchase receipt as a proof of purchase date. Please note that freight and insurance to and / or from your nearest Authorised Service Centre must be arranged by you.
 - Note that home or pick-up/delivery service is available for the following products in the major metropolitan areas of Australia or the normal operating areas of the nearest Authorised Service Centres:
 - Plasma/LCD televisions / displays (screen size greater than 103 cm)
7. The warranties hereby conferred do not extend to, and exclude, any costs associated with the installation, de-installation or re-installation of a product, including costs related to the mounting, de-mounting or remounting of any screen, (and any other ancillary activities), delivery, handling, freighting, transportation or insurance of the product or any part thereof or replacement of and do not extend to, and exclude, any damage or loss occurring by reason of, during, associated with, or related to such installation, de-installation, re-installation or transit.

Panasonic Authorised Service Centres are located in major metropolitan areas and most regional centres of Australia, however, coverage will vary dependant on product. For advice on exact Authorised Service Centre locations for your product, please telephone our Customer Care Centre on 132600 or visit our website and use the Service Centre Locator.

In addition to your rights under this warranty, Panasonic products come with consumer guarantees that cannot be excluded under the Australian Consumer Law. If there is a major failure with the product, you can reject the product and elect to have a refund or to have the product replaced or if you wish you may elect to keep the goods and be compensated for the drop in value of the goods. You are also entitled to have the product repaired or replaced if the product fails to be of acceptable quality and the failure does not amount to a major failure.

If there is a major failure in regard to the product which cannot be remedied then you must notify us within a reasonable period by contacting the Panasonic Customer Care Centre. If the failure in the product is not a major failure then Panasonic may choose to repair or replace the product and will do so in a reasonable period of time from receiving notice from you.

THIS WARRANTY CARD AND THE PURCHASE DOCKET (OR SIMILAR PROOF OF PURCHASE) SHOULD BE RETAINED BY THE CUSTOMER AT ALL TIMES

If you require assistance regarding warranty conditions or any other enquiries, please visit the **Panasonic Australia** website www.panasonic.com.au or contact by phone on **132 600**
If phoning in, please ensure you have your operating instructions available.

Panasonic Australia Pty. Limited

ACN 001 592 187 ABN 83 001 592 187

1 Innovation Road, Macquarie Park NSW 2113

PRO-031-F11 Issue: 4.0

01-01-2011

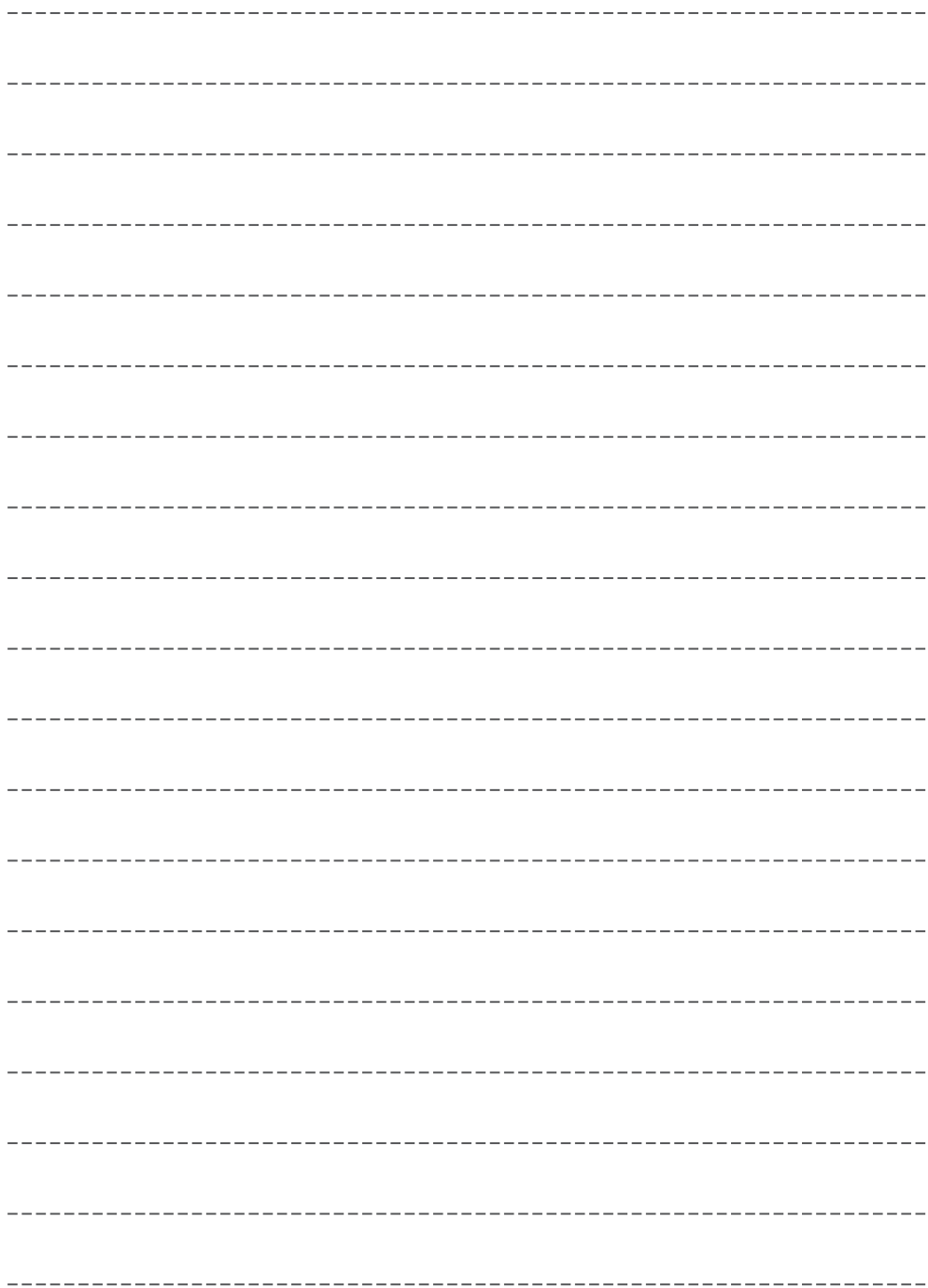

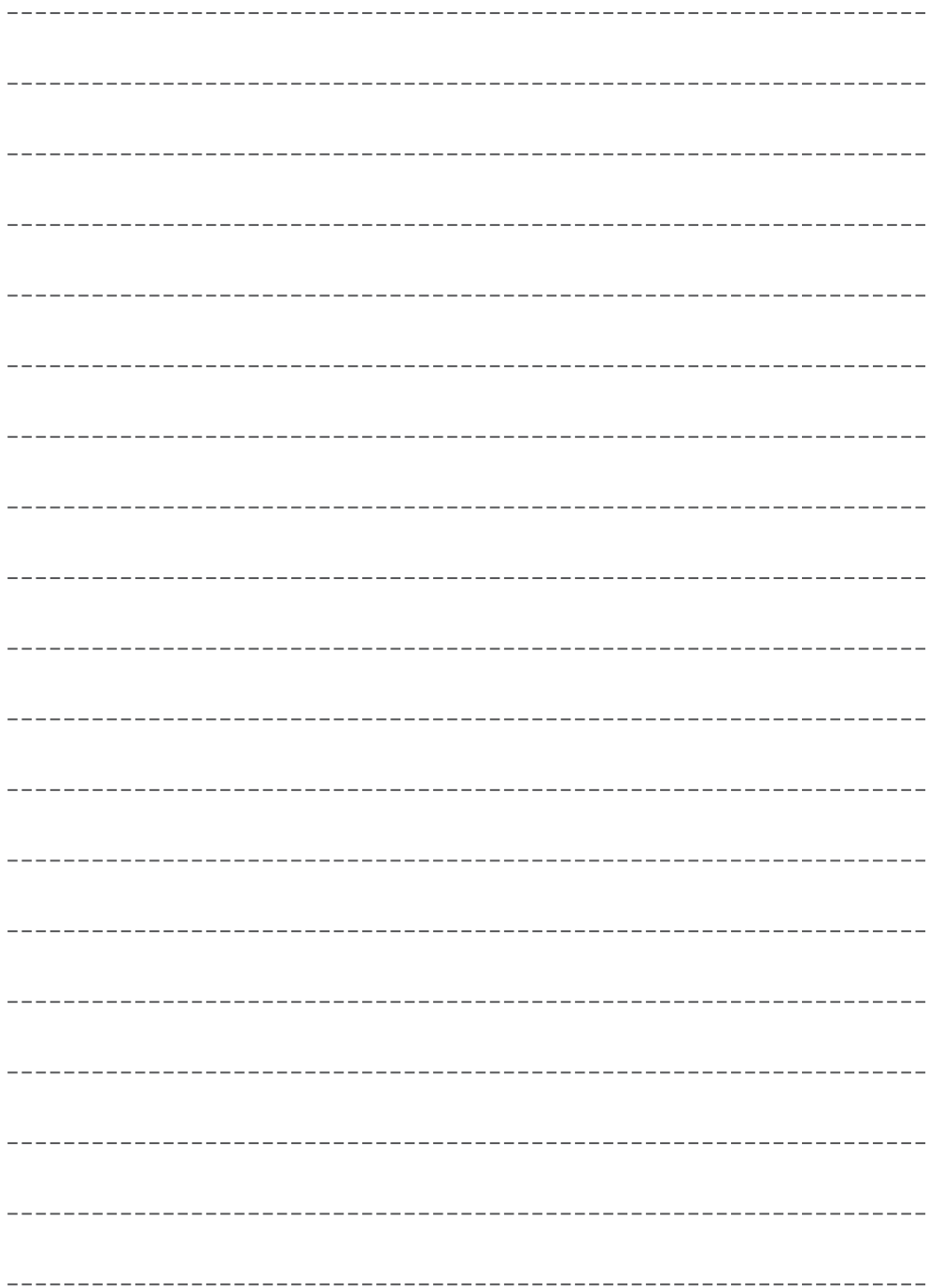

Information on Disposal in other Countries outside the European Union



This symbol is only valid in the European Union. If you wish to discard this product, please contact your local authorities or dealer and ask for the correct method of disposal.

Customer's Record

The model number and serial number of this product may be found on its rear panel. You should note this serial number in the space provided below and retain this book, plus your purchase receipt, as a permanent record of your purchase to aid in identification in the event of theft or loss, and for Warranty Service purposes.

Model Number

Serial Number

Panasonic Corporation

Web Site: <http://www.panasonic.com>

English