

## Basic Operating Instructions

---

### High Definition Video Camera

Model No.

**HC-V800**

**HC-V808**

### 4K Video Camera

Model No.

**HC-WXF1**

**HC-WXF1M**

**HC-VXF1**

**HC-VXF11**

**HC-VX1**

**HC-VX11**

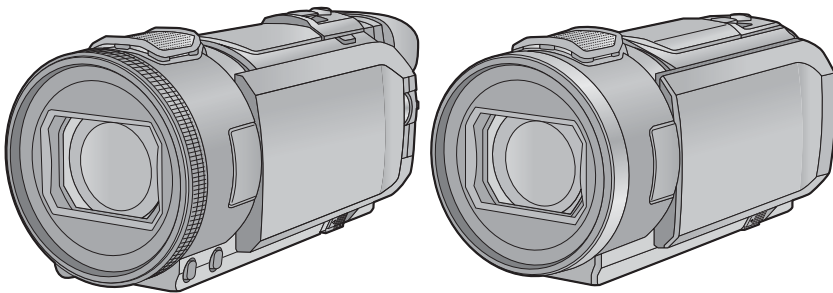

Please read these instructions carefully before using this product, and save this manual for future use.

More detailed operating instructions are available in “Operating Instructions (PDF format)”. To read it, download it from the website.

<https://www.pavc.panasonic.co.jp/hdw/oi/WXF1/>

- Click the desired language.



DVQX1456ZA

F0218SQ0

# Information for Your Safety

## **WARNING:**

To reduce the risk of fire, electric shock or product damage,

- Do not expose this unit to rain, moisture, dripping or splashing.
- Do not place objects filled with liquids, such as vases, on this unit.
- Use the recommended accessories.
- Do not remove covers.
- Do not repair this unit by yourself. Refer servicing to qualified service personnel.

## **CAUTION!**

To reduce the risk of fire, electric shock or product damage,

- Do not install or place this unit in a bookcase, built-in cabinet or in another confined space. Ensure this unit is well ventilated.
- Do not obstruct this unit's ventilation openings with newspapers, tablecloths, curtains, and similar items.
- Do not place sources of naked flames, such as lighted candles, on this unit.

The mains plug is the disconnecting device. Install this unit so that the mains plug can be unplugged from the socket outlet immediately.

### **(GN)**

This unit is intended for use in moderate climates.

### **(GC/GW)**

This unit is intended for use in moderate and tropical climates.

## **■ Concerning the battery**

### **Warning**

Risk of fire, explosion and burns. Do not disassemble, heat above 60 °C or incinerate.

## **CAUTION**

- Danger of explosion if battery is incorrectly replaced. Replace only with the type recommended by the manufacturer.
- When disposing of the batteries, please contact your local authorities or dealer and ask for the correct method of disposal.

## ■ Product identification marking

Product	Location
WXF1 series/VXF1 series/VX1 series 4K Video Camera	Battery holder
V800 series High Definition Video Camera	Battery holder
AC adaptor	Bottom

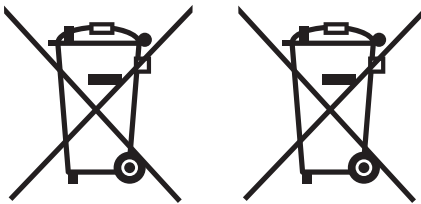

**Disposal of Old Equipment and Batteries  
Only for European Union and countries with  
recycle systems**

These symbols are only valid in the European Union and countries with recycle systems.  
If you wish to discard this product, please contact your local authorities or dealer and ask for the correct method of disposal.

### For Singapore only

Complies with  
IMDA Standards  
DB01017

### For India only

The specifications are exempted for any licensing requirement by Ministry of Communications and Information Technology, G.S.R. 45 (E), dated 28th January, 2005.

### For Thailand only

This telecommunication equipment conforms to NTC/NBTC technical requirement.

[ For India only ]

## Battery pack information

IS 16046/IEC 62133

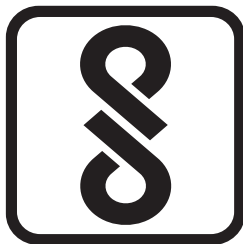

R-41018350

## ■ Cautions for use

The unit and the SD card become warm during use. This is not a malfunction.

**Keep this unit as far away as possible from electromagnetic equipment (such as microwave ovens, TVs, video games etc.).**

- If you use this unit on top of or near a TV, the pictures and/or sound on this unit may be disrupted by electromagnetic wave radiation.
- Do not use this unit near cell phones because doing so may result in noise adversely affecting the pictures and/or sound.
- Recorded data may be damaged, or pictures may be distorted, by strong magnetic fields created by speakers or large motors.
- Electromagnetic wave radiation generated by microprocessors may adversely affect this unit, disturbing the pictures and/or sound.
- If this unit is adversely affected by electromagnetic equipment and stops functioning properly, turn this unit off and remove the battery or disconnect AC adaptor. Then reinsert the battery or reconnect AC adaptor and turn this unit on.

**Do not use this unit near radio transmitters or high-voltage lines.**

- If you record near radio transmitters or high-voltage lines, the recorded pictures and/or sound may be adversely affected.

**About connecting to a PC**

- Do not use any other USB cables except the supplied one.

**About connecting to a TV**

- Do not use any other HDMI micro cables except the supplied one.

**About using a headphone**

- Excessive sound pressure from earphones and headphones can cause hearing loss.

**Make sure to use the supplied cords and cables. If you use optional accessories, use the cords and the cables supplied with them.**

**Do not extend the cords and the cables.**

**Do not spray insecticides or volatile chemicals onto the unit.**

- If the unit is sprayed with such chemicals, its body may be marred and the surface finish may peel off.

**Do not leave rubber or plastic products in contact with the unit for a long time.**

**Cleaning**

- Before cleaning, detach the battery or pull the AC adaptor from the AC outlet, and then wipe the unit with a soft, dry cloth.
- If the unit is very dirty, dip a cloth in water and squeeze firmly, and then wipe the unit with the damp cloth. Next, dry the unit with a dry cloth.
- Use of benzine, paint thinner, alcohol, or dishwashing liquid may alter the camera body or peel the surface finish. Do not use these solvents.
- When using a chemical dust cloth, follow the instructions that came with the cloth.

**When you are not going to use the unit for an extended time**

- When storing the unit in a cupboard or cabinet, it is recommended that you place a desiccant (silica gel) in with it.

### Be sure to detach the battery after use.

- If the battery is left attached, a minute amount of current continues to flow even if the unit is off. Keeping the unit in this state may result in over discharge of the battery. This may result in you not being able to use the battery even after it is charged.
- The battery should be stored in a cool place free from humidity, with as constant temperature as possible. (Recommended temperature: 15 °C to 25 °C, Recommended humidity: 40%RH to 60%RH)
- To store the battery for a long period of time, we recommend you charge it once every year and store it again after you have completely used up the charged capacity.

If the operating time is very short even after the battery has been recharged, the battery has worn out. Please purchase a new battery.

### About the SD card

- When the card access lamp is lit, do not:
  - Remove the SD card
  - Turn the unit off
  - Insert and remove the USB cable
  - Expose the unit to vibrations or shock

### About the accessory shoe cover

- Close accessory shoe cover **A** when not using the accessory shoe.
- For details about accessory shoe cover, refer to the Operating Instructions (PDF format).

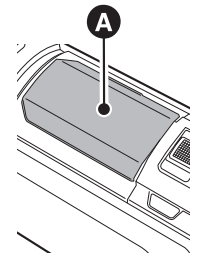

## ■ About the recording format for recording motion pictures

- Motion pictures recorded with other devices are not supported by this unit.

(For the **WXF1** series/ **VXF1** series/ **VX1** series)

You can select from AVCHD<sup>\*1</sup>, 4K MP4<sup>\*2</sup>, MP4<sup>\*2</sup> or 24p<sup>\*2</sup> recording formats to record motion pictures using this unit.

(For the **V800** series)

You can select from AVCHD<sup>\*1</sup>, MP4<sup>\*2</sup> or 24p<sup>\*2</sup> recording formats to record motion pictures using this unit.

\*1 It is compatible with the AVCHD Progressive (1080/50p).

\*2 It is not compatible with motion pictures recorded in AVCHD format.

### AVCHD:

It is suitable for viewing on a high-definition TV or for saving to disc<sup>\*3</sup>.

\*3 Images recorded in 1080/50p can be saved using the following methods:

- Copying to a disc using the HD Writer AE 5.4.
- Copying to a Panasonic Blu-ray disc recorder that supports AVCHD Progressive.

### 4K MP4 (For the **WXF1** series/ **VXF1** series/ **VX1** series):

This is a recording format suitable for editing images.

This format can record 4K motion pictures (3840×2160/25p), which deliver a resolution four times higher than that of full high-definition motion pictures.

### MP4:

This is a recording format suitable for playing back or editing on a PC.

## 24p:

This allows you to record images similar to those shot on a roll of cinema film.

(For the **WXF1** series/**VXF1** series/**VX1** series)

Images can be recorded as 4K motion pictures (3840×2160/24p) or in high-definition picture quality (1920×1080/24p).

(For the **V800** series)

Images can be recorded as high-definition picture quality (1920×1080/24p).

- This unit restarts when you change the [REC FORMAT] setting to [24p] or change it from [24p] to a different setting.

## ■ Indemnity about recorded content

Panasonic does not accept any responsibility for damages directly or indirectly due to any type of problems that result in loss of recording or edited content, and does not guarantee any content if recording or editing does not work properly. Likewise, the above also applies in a case where any type of repair is made to the unit (including any other non-built-in memory related component).

## ■ About Condensation

### (When the lens, the viewfinder\* or LCD Monitor is fogged up)

Condensation occurs when there is a change in temperature or humidity, such as when the unit is taken from outside or a cold room to a warm room. Please be careful, as it may cause the lens, the viewfinder or LCD monitor to become soiled, moldy, or damaged.

When taking the unit to a place which has a different temperature, if the unit is accustomed to the room temperature of the destination for about one hour, condensation can be prevented. (When the difference in temperature is severe, place the unit in a plastic bag or the like, remove air from the bag, and seal the bag.)

When condensation has occurred, remove the battery and/or the AC adapter and leave the unit like that for about one hour. When the unit becomes accustomed to the surrounding temperature, foginess will disappear naturally.

\* For the **WXF1** series/**VXF1** series

## ■ Cards that you can use with this unit

### SD Memory Card, SDHC Memory Card and SDXC Memory Card





- 4 GB or more Memory Cards that do not have the SDHC logo or 48 GB or more Memory Cards that do not have the SDXC logo are not based on SD Memory Card Specifications.
- Refer to page 15 for more details on SD cards.

## ■ Caution regarding the lens and the viewfinder\*

Do not aim the lens or the viewfinder at the sun or strong light. Doing so may cause the unit to malfunction.

\* For the **WXF1** series/**VXF1** series

## ■ For the purposes of these operating instructions

- SD Memory Card, SDHC Memory Card and SDXC Memory Card are referred to as the “SD card”.
- The smartphone and tablet are indicated as “smartphone”.
- Function that can be used for Motion Picture Recording Mode: 
- Function that can be used for Still Picture Recording Mode: 
- Function that can be used for the Playback Mode: 
- Function that can be used for the Playback Mode (motion pictures only): 
- Function that can be used for the Playback Mode (still pictures only): 
- Scene(s) recorded in the recording format [AVCHD]: “AVCHD scene(s)”

- (For the **WXF1** series/**VXF1** series/**VX1** series)  
Scene(s) recorded in the recording format [4K MP4] and scene(s) recorded in 4K PHOTO mode: “4K MP4 scene(s)”
- Scene(s) recorded in the recording format [MP4] and scene(s) saved in MP4 (1920×1080/25p), MP4 (1280×720/25p) or MP4 (640×360/25p): “MP4 scene(s)”
- Scene(s) recorded in the recording format [24p]: “24p scene(s)”
- Scene(s) containing only the Main Camera’s image that was recorded separately from a simultaneously recorded normal scene when [Backup for Twin Camera] was set to [ON]: “Scene(s) recorded as Backup for Twin Camera”
- Pages for reference are indicated by an arrow, for example: → 00
- (For the **WXF1** series/**VXF1** series)  
Fn buttons set as follows in [FN BUTTON SETTING]
  - Fn button set as [ (Wi-Fi)]: “Wi-Fi button”
  - Fn button set as [ (HDR Movie)]: “HDR button”
  - Fn button set as [ (PHOTOSHOT)]: “Photoshot button”
  - Fn button set as [ (REC MODE CHANGE)]: “Recording Mode selector button”
- Model numbers are abbreviated as follows in these operating instructions:

Model number	Abbreviation used in these operating instructions	
HC-WXF1	<b>WXF1</b> [WXF1]	<b>WXF1</b> series/ [WXF1] series
HC-WXF1M	<b>WXF1M</b> [WXF1M]	
HC-VXF1	<b>VXF1</b> [VXF1]	<b>VXF1</b> series/ [VXF1] series
HC-VXF11	<b>VXF11</b> [VXF11]	
HC-VX1	<b>VX1</b> [VX1]	<b>VX1</b> series/ [VX1] series
HC-VX11	<b>VX11</b> [VX11]	
HC-V800	<b>V800</b> [V800]	<b>V800</b> series/ [V800] series
HC-V808	<b>V808</b> [V808]	

These operating instructions are designed for use with models **WXF1** series, **VXF1** series, **VX1** series and **V800** series. Pictures may be slightly different from the original.

- The illustrations used in these operating instructions show model **VX1**, however, parts of the explanation refer to different models.
- Depending on the model, some functions are not available.
- Features may vary, so please read carefully.
- Not all models may be available depending on the region of purchase.

## ■ Installing HD Writer AE 5.4

Check the website below to download/install the software.

- The software is available for download until the end of March 2021.

[http://panasonic.jp/support/global/cs/soft/download/f\\_ae54.html](http://panasonic.jp/support/global/cs/soft/download/f_ae54.html)

## ■ Downloading the Operating Instructions (PDF format)

You can check the URL and QR code of the website where you can download the Operating Instructions (PDF format) in [ONLINE MANUAL] in the Setup menu.

- Touch ◀ (left side)/ ▶ (right side) of  on the Touch Menu to display  . (→ 21)

1 Touch  .

2 Touch [SETUP].

3 Touch [ONLINE MANUAL].

4 Touch the access method you want to check.

### [URL display]:

Displays the URL of the website on the LCD monitor of this unit.

### [USB connect]:

Displays the website on a PC connected to this unit with the USB cable. Click [OIBOOK], which will be displayed on the PC.

### [QR code]:

Displays the QR code of the website on the LCD monitor of this unit.

- You will need Adobe Reader to browse or print the Operating Instructions (PDF format).  
You can download and install a version of Adobe Reader that you can use with your OS from the following website. (As of January 2018)

<http://www.adobe.com/products/acrobat/readstep2.html>



# Contents

Information for Your Safety .....	2
Accessories .....	10

---

## Preparation

---

<b>Power supply</b> .....	11
Inserting/removing the battery.....	11
Charging the battery .....	12
Charging and recording time.....	13
<b>Recording to a card</b> .....	15
Cards that you can use with this unit .....	15
Inserting/removing an SD card.....	16
<b>Turning the unit on/off</b> .....	17
<b>Selecting a mode</b> .....	18
Switching this unit between Recording Mode and Playback Mode .....	18
Switching this unit between Motion Picture Recording Mode and Still Picture Recording Mode.....	19
<b>LCD monitor/viewfinder</b> .....	20
How to use the touch screen .....	20
Viewfinder adjustment [WXF1] series/[VXF1] series .....	21
About the Touch Menu.....	21
<b>Setting date and time</b> .....	22
<b>Setting your home region for the first time</b> .....	22

---

## Basic

---

<b>Selecting a media to record</b> [WXF1M] .....	23
<b>Changing the Recording Mode</b> .....	23
<b>Recording motion pictures</b> .....	25
<b>Recording still pictures</b> .....	25
<b>Recording with the Sub Camera (Twin Camera) [WXF1] series</b> .....	26
<b>Motion picture/ Still picture playback</b> .....	27
Watching Video/ Pictures on your TV .....	28
<b>Using the menu screen</b> .....	29
Language selection .....	29
Formatting .....	29

---

## Wi-Fi

---

<b>What you can do with the Wi-Fi<sup>®</sup> function</b> .....	30
<b>[Remote Ctrl]</b> .....	31
Install the “Image App” .....	31
Preparations before using [Remote Ctrl].....	32
Using [Remote Ctrl] with a direct connection.....	33
About [Remote Ctrl] .....	34
<b>Wireless Twin/ Multi-Camera function</b> .....	35

---

## Others

---

<b>Troubleshooting</b> .....	36
<b>Specifications</b> .....	38
<b>About copyright</b> .....	41
<b>Limited Warranty (ONLY FOR AUSTRALIA)</b> .....	43

# Accessories

Check the accessories before using this unit.

Keep the accessories out of reach of children to prevent swallowing.

Product numbers correct as of Jan. 2018. These may be subject to change.

## Battery pack

VW-VBT190



## AC adaptor

(GC)

(A) VSK0815N

(B) VSK0815K

- In Saudi Arabia, always use (A)

(GW)

(C) VSK0815Q

(GN)

(D) VSK0815M

(A)

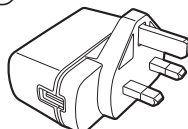

(B)

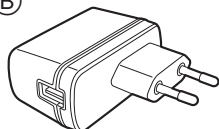

(C)

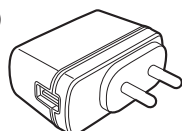

(D)

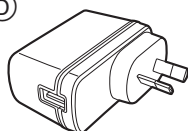

## DC cable

K2GHYY00004

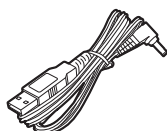

## USB cable

K1HY04YY0106



## HDMI micro cable

K1HY19YY0055



## Lens hood

DVZE1023Z

- For details on how to attach the lens hood, refer to the Operating Instructions (PDF format).



## Optional accessories

Some optional accessories may not be available in some countries.

(GC)

Battery charger (VW-BC10E/EB)

(GN)

Battery charger (VW-BC10GN)

Battery pack (lithium/VW-VBT190)

Battery pack (lithium/VW-VBT380)

Stereo microphone (VW-VMS10E)

(GC)

Accessory kit (VW-ACT190E/EB, VW-ACT380E)

(GN)

Accessory kit (VW-ACT190GN)

LED Video Light (VW-LED1E)

(GC)

Remote Pan Tilt Cradle (VW-CTR1E/EB)

(GN)

Remote Pan Tilt Cradle (VW-CTR1GN)

# Power supply

## ■ About batteries that you can use with this unit

The battery that can be used with this unit is VW-VBT190/VW-VBT380.

- The unit has a function for distinguishing batteries which can be used safely. The dedicated battery (VW-VBT190/VW-VBT380) supports this function. The only batteries suitable for use with this unit are genuine Panasonic products and batteries manufactured by other companies and certified by Panasonic. Panasonic cannot in any way guarantee the quality, performance or safety of batteries which have been manufactured by other companies and are not genuine Panasonic products.

It has been found that counterfeit battery packs which look very similar to the genuine product are made available to purchase in some markets. Some of these battery packs are not adequately protected with internal protection to meet the requirements of appropriate safety standards. There is a possibility that these battery packs may lead to fire or explosion. Please be advised that we are not liable for any accident or failure occurring as a result of use of a counterfeit battery pack. To ensure that safe products are used we would recommend that a genuine Panasonic battery pack is used.

## Inserting/removing the battery

- Press the power button to turn off the unit. (→ 17)

Install the battery by inserting it in the direction shown in the figure.

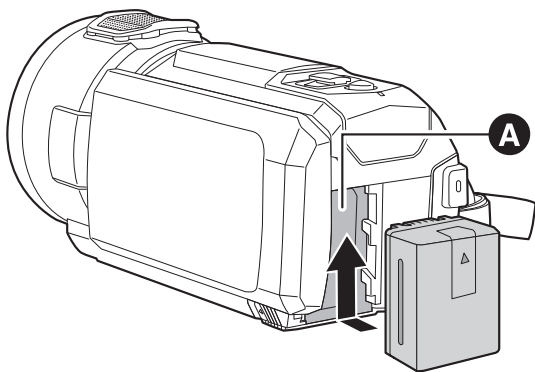

**A** Battery holder

Insert the battery until it clicks and locks.

### Removing the battery

Be sure to hold down the power button until the status indicator goes off. Then remove the battery while supporting the unit to prevent it from dropping. **Move the battery release lever in the direction indicated by the arrow and remove the battery when unlocked.**

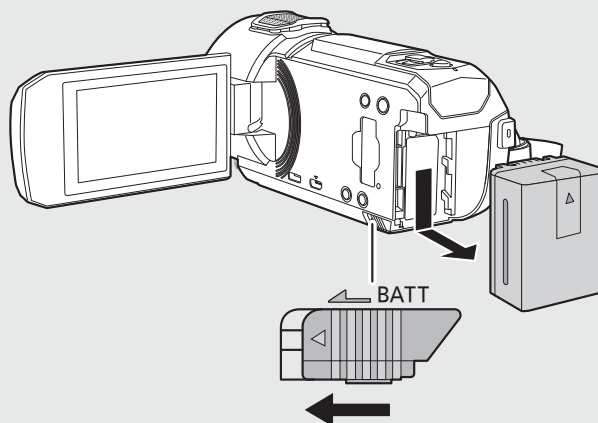

# Charging the battery

**When this unit is purchased, the battery is not charged. Charge the battery fully before using this unit for the first time.**

The unit is in the standby condition when the AC adaptor is connected. The primary circuit is always “live” as long as the AC adaptor is connected to an electrical outlet.

## Important:

- Do not use the AC adaptor/DC cable with any other equipment as it is designed only for this unit. Also, do not use the AC adaptor/DC cable from other equipment with this unit.
- The battery will not be charged if the unit is turned on.
- It is recommended to charge the battery in a temperature between 10 °C and 30 °C. (The battery temperature should also be the same.)

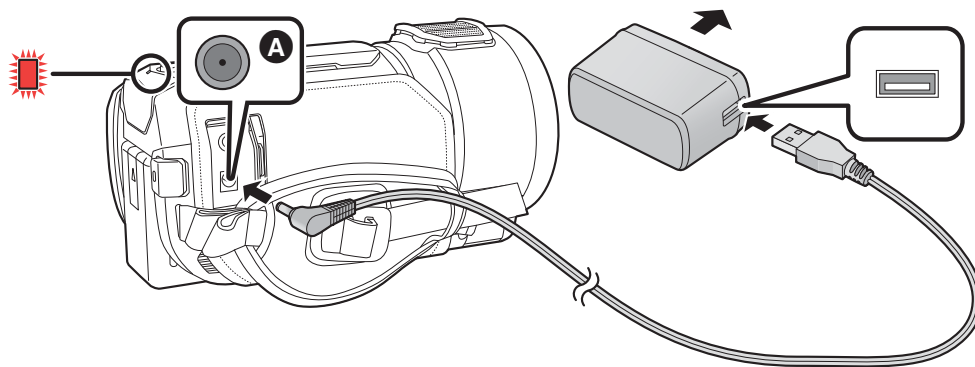

**A** DC input terminal

**1** Connect the DC cable to the AC adaptor and to the DC input terminal of this unit.

- Insert the plugs as far as they will go.

**2** Insert the AC adaptor into an AC outlet.

- The status indicator will flash red at an interval of approximately 2 seconds (approximately 1 second on, approximately 1 second off), indicating that charging has begun. It will turn off when the charging is completed. (→ 17)

## ■ Connecting to the AC outlet

It is possible to use this unit with power supplied from the AC outlet by turning on the unit with the AC adaptor connected.

Even when you use the AC adaptor for recording images, keep the battery connected.

This allows you to continue the recording even if a power failure occurs or the AC adaptor is unplugged from the AC outlet by accident.

## ■ To charge by connecting to other device

It is possible to charge by connecting to other device with the USB cable (supplied).

- Do not use any other DC cables except the supplied one.
- Do not use any other AC adaptors except the supplied one.
- We recommend using Panasonic batteries (→ 11).
- If you use other batteries, we cannot guarantee the quality of this product.
- Do not heat or expose to flame.
- Do not leave the battery(ies) in a car exposed to direct sunlight for a long period of time with doors and windows closed.

# Charging and recording time

## ■ Charging/Recording time

- Temperature: 25 °C/humidity: 60%RH
- When using the LCD monitor
- **The indicated charging time is for when the battery has been discharged completely. Charging time and recordable time vary depending on the usage conditions such as high/low temperature.**
- Charging times in parentheses are when charging from the USB terminal.

### For the WXF1 series/VXF1 series

- Maximum continuous recordable times and actual recordable times in round parentheses are the values when the viewfinder is used.
- (For the WXF1 series)  
Maximum continuous recordable times and actual recordable times in square parentheses are the values when recording is performed with the Sub Camera in combination with the LCD monitor\*.
- \* These include times when  is displayed on the screen.

Battery model number [Voltage/Capacity (minimum)]	Charging time	Recording format	Recording mode	Maximum continuous recordable time	Actual recordable time
Supplied battery/ VW-VBT190 (optional) [3.6 V/1940 mAh]	2 h 20 min (5 h 20 min)	[4K MP4]	[2160]	1 h 35 min (1 h 40 min) [1 h 15 min]	45 min (50 min) [35 min]
		[MP4]	[1080/50M]	1 h 45 min (1 h 55 min) [1 h 20 min]	55 min (55 min) [40 min]
			[1080/28M]	1 h 45 min (1 h 55 min) [1 h 25 min]	55 min (1 h) [40 min]
			[720]	2 h 5 min (2 h 15 min) [1 h 35 min]	1 h 5 min (1 h 10 min) [50 min]
		[AVCHD]	[1080/50p]	1 h 45 min (1 h 55 min) [1 h 25 min]	55 min (1 h) [40 min]
			[PH]	1 h 50 min (1 h 55 min) [1 h 25 min]	55 min (1 h) [45 min]
			[HA], [HG], [HE]	1 h 50 min (2 h) [1 h 25 min]	
		[24p]	[2160/24p]	1 h 35 min (1 h 40 min)	50 min (50 min)
			[1080/24p]	1 h 45 min (1 h 50 min)	55 min (55 min)

## For the **VX1** series/**V800** series

\* **VX1** series only

Battery model number [Voltage/Capacity (minimum)]	Charging time	Recording format	Recording mode	Maximum continuous recordable time	Actual recordable time
Supplied battery/ VW-VBT190 (optional) [3.6 V/1940 mAh]	2 h 20 min (5 h 20 min)	[4K MP4]*	[2160]	1 h 35 min	45 min
		[MP4]	[1080/50M]	1 h 45 min	55 min
			[1080/28M]		
			[720]	2 h 5 min	1 h 5 min
		[AVCHD]	[1080/50p]	1 h 45 min	55 min
			[PH], [HA], [HG], [HE]	1 h 50 min	
		[24p]	[2160/24p]*	1 h 35 min	50 min
			[1080/24p]	1 h 45 min	55 min

- “h” is an abbreviation for hour, “min” for minute and “s” for second.
- These times are approximations.
- The actual recordable time refers to the recordable time when repeatedly starting/stopping recording, turning the unit on/off, moving the zoom lever etc.

### ■ Battery capacity indication

The battery capacity indication is displayed on the LCD monitor.

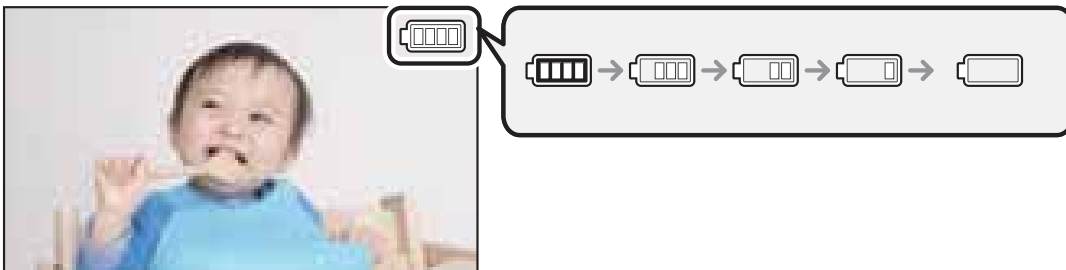

- If there is less than 3 minutes remaining, then  will become red. If the battery discharges, then  will flash. Recharge the battery or replace it with a fully charged battery.

# Recording to a card

The unit can record still pictures or motion pictures to an SD card or built-in memory\*. To record to an SD card, read the following.

\* **[WXF1M]** only

## Cards that you can use with this unit

Card type	Capacity
SD Memory Card	512 MB to 2 GB
SDHC Memory Card	4 GB to 32 GB
SDXC Memory Card	48 GB to 128 GB

- Please check the latest information on the support website below.  
[http://panasonic.jp/support/global/cs/e\\_cam](http://panasonic.jp/support/global/cs/e_cam)  
(This website is in English only.)
- We do not guarantee the operation of SD cards other than the ones above.
- Operation is not guaranteed for all SD cards.
- Keep the memory card out of reach of children to prevent swallowing.

### ■ About the Speed Class ratings for recording motion pictures

Depending on [REC MODE] and [REC FORMAT], the required card differs.

Use a card that meets the following ratings of the SD Speed Class. Use of a non-compatible card may cause recording to stop suddenly.

- SD Speed Class is the speed standards regarding continuous writing. To check the class, see the labelled side, etc. of the card.

Recording formats	Recording modes	Speed Class ratings	Label examples
4K MP4*	[2160]	Class 10	CLASS 10
24p	All		
MP4	[1080/50M]		
	[1080/28M], [720]	Class 4 or more	CLASS 4
AVCHD	All		

\* For the **[WXF1]** series/ **[VXF1]** series/ **[VX1]** series

- In the following situations, you need an SD card conforming to Class 10 of the SD Speed Class Rating to record motion pictures.

Use of a non-compatible card may cause recording to stop suddenly.

- FULL HD Slow Motion Video Mode
- When [Backup for Twin Camera] is set to [ON]

(For the **[WXF1]** series/ **[VXF1]** series/ **[VX1]** series)

- 4K Photo Mode
- Slow & Quick Video Mode

# Inserting/removing an SD card

When using an SD card not from Panasonic, or one previously used on other equipment, for the first time on this unit, format the SD card. (→ 29) When the SD card is formatted, all of the recorded data is deleted. Once the data is deleted, it cannot be restored.

## Caution:

Check that the access lamp has gone off.

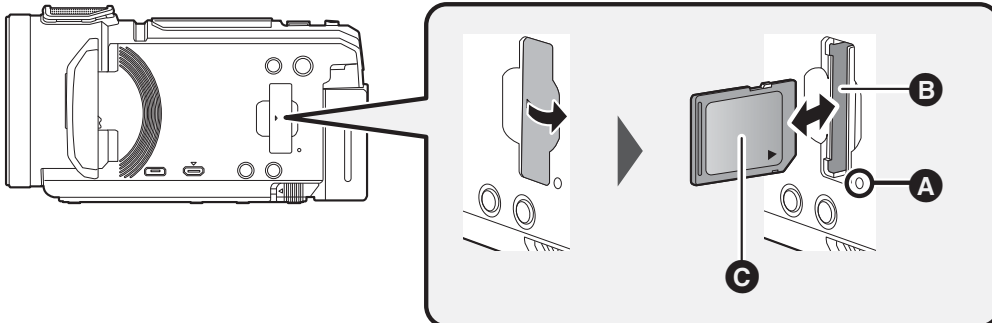

## Access lamp [ACCESS] **A**

- When this unit is accessing the SD card or built-in memory, the access lamp lights up.

### **1** Open the SD card cover and insert (remove) the SD card into (from) the card slot **B**.

- Face the label side **C** in the direction shown in the illustration and press it straight in as far as it will go.
- Press the centre of the SD card and then pull it straight out.

### **2** Securely close the SD card cover.

- Securely close it until it clicks.



# Turning the unit on/off

You can turn the unit on and off using the power button or by opening and closing the LCD monitor.

## Turning the unit on and off with the power button

Open the LCD monitor and press the power button to turn on the unit.

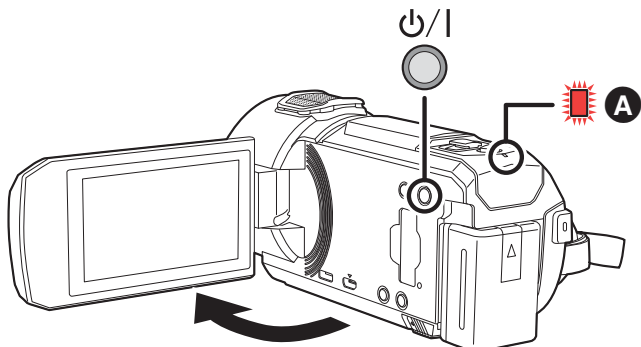

### To turn off the unit

Hold down the power button until the status indicator goes off.

**A** The status indicator lights on.

The unit is turned on when the LCD monitor is opened, and unit is turned off when it is closed.

● (For the **WXF1** series/**VXF1** series)

- You can also turn the unit on and off using the viewfinder.
- The unit will not turn off unless the LCD monitor is closed and the viewfinder is retracted.
- When the viewfinder is extended, opening the LCD monitor turns off the viewfinder and turns on the LCD monitor.

The viewfinder may turn on depending on the settings for the [LCD/EVF CHANGE] in the Fn button function. For information about the Fn button functions, refer to the Operating Instruction (PDF format).

## ■ Overheat detection

When the internal temperature of the unit rises during use, a message will be displayed. When this happens, the unit will turn off automatically a few minutes later.

- Wait until the temperature has dropped before resuming use.

If you try to use the Wi-Fi function while the internal temperature of this unit is high, a message will be displayed. When this happens, the Wi-Fi function is disabled.

- Wait until the temperature has dropped before resuming use.

## Selecting a mode

You can switch this unit between Recording Mode (Motion Picture Recording Mode/Still Picture Recording Mode) and Playback Mode by pressing the recording/playback button.

If you touch the recording mode switching icon in Recording Mode, this unit can be switched between Motion Picture Recording Mode and Still Picture Recording Mode.

- (For the **WXF1** series/**VXF1** series)

In Recording Mode, pressing the recording mode selector button allows you to switch between Motion Picture Recording Mode, 4K Photo Mode and Still Picture Recording Mode. (→ 19)

<b>Motion Picture Recording Mode (→ 25)</b>	<b>Recording motion pictures.</b>
<b>Still Picture Recording Mode (→ 25)</b>	<b>Recording still pictures.</b>
<b>Playback Mode (→ 27)</b>	<b>Motion picture/Still picture playback.</b>

## Switching this unit between Recording Mode and Playback Mode

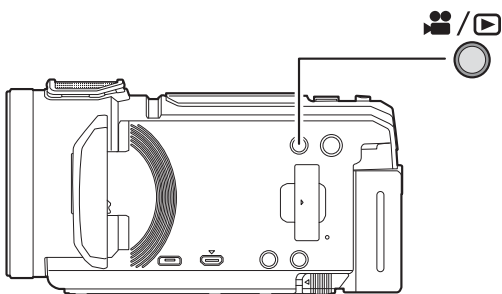

### Recording/playback button

Press the button to switch this unit between Recording Mode and Playback Mode.

- When you turn on this unit, it starts up in Recording Mode.

# Switching this unit between Motion Picture Recording Mode and Still Picture Recording Mode

WXF1 series / VXF1 series

Pressing a button to switch between Motion Picture Recording Mode and Still Picture Recording Mode

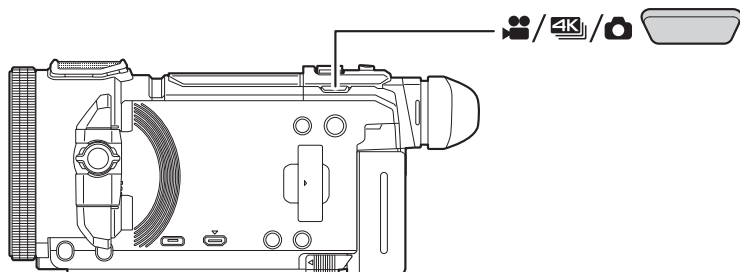

## Recording mode selector button

Each time you press this button, the Recording Mode switches in the following order: Motion Picture Recording Mode → 4K Photo Mode\* → Still Picture Recording Mode

\* The unit does not switch to 4K Photo Mode in the following cases:



- When the Wireless Twin Camera function is in use
- Night Mode

## Touching an icon to switch between Motion Picture Recording Mode and Still Picture Recording Mode

Touch the recording mode switching icon displayed on the LCD monitor (touch screen) to switch this unit between Motion Picture Recording Mode and Still Picture Recording Mode.

### 1 Press the recording/playback button to switch this unit to Recording Mode.

- The recording mode switching icon **A** is displayed on the screen.

	Motion Picture Recording Mode
	Still Picture Recording Mode

### 2 Touch the recording mode switching icon.

- Refer to page 20 for touch screen operation.

(Motion Picture Recording Mode)

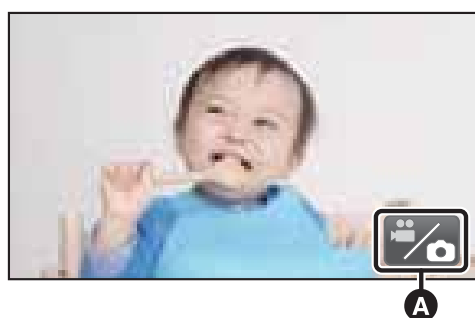

## To display the recording mode switching icon

Display of the recording mode switching icon will disappear when no touch operation is performed for a specific period of time. To display it again, touch the screen.

- The recording mode selector button and the recording mode switching icon are disabled when the Wireless Multi-Camera function is enabled.
- If the recording start/stop button is pressed in Still Picture Recording Mode or Playback Mode, this unit will be switched to Motion Picture Recording Mode. During motion picture/still picture playback or in other conditions, even if the recording start/stop button is pressed, the recording mode may not be switched.
- When you switch between Motion Picture Recording Mode, 4K Photo Mode\* and Still Picture Recording Mode, settings used in the original recording mode may not be maintained. (→ 23)
- You cannot switch to Still Picture Recording Mode when [REC FORMAT] is set to [24p].

\* For the **WXF1** series/ **VXF1** series/ **VX1** series

Preparation

# LCD monitor/viewfinder

## How to use the touch screen

You can operate by directly touching the LCD monitor (touch screen) with your finger.

### ■ Touch

Touch and release the touch screen to select icon or picture.

- Touch the centre of the icon.
- Touching the touch screen will not operate while you are touching another part of the touch screen.

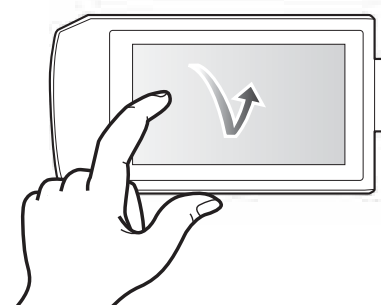

### ■ Slide while touching

Move your finger while pressing on the touch screen.

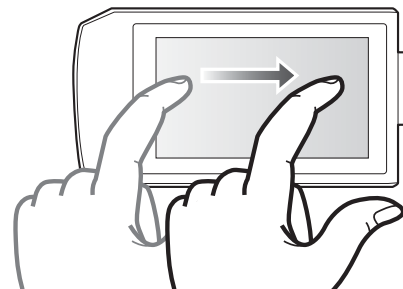

### ■ About the operation icons

▲ / ▼ / ◀ / ▶ :

Touch when changing a page or performing settings.

↶ :

Touch to return to the previous screen.

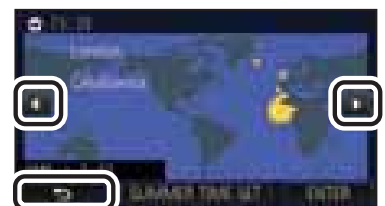

- (For the **WXF1** series/ **VXF1** series)  
When the viewfinder is in use, on-screen icons will be displayed but disabled.  
Open the LCD monitor to touch them.

# Viewfinder adjustment [WXF1] series/[VXF1] series

## ■ Diopter adjustment

Adjust to make the image clear by rotating the diopter adjustment dial.

- Extend the viewfinder and close the LCD monitor to turn on the viewfinder.
- The viewfinder can be raised up to approximately 50° **A**.
- When moving the viewfinder, be careful not to catch your fingers.

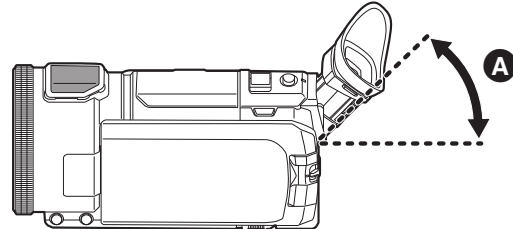
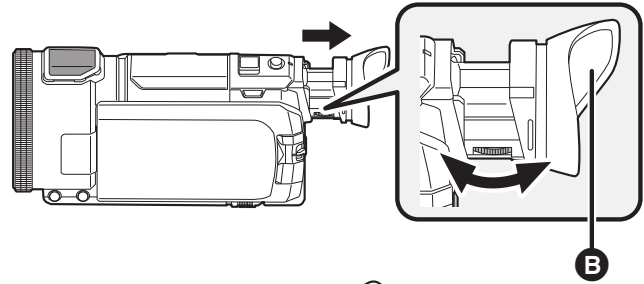

## ■ About the eyecup

If you remove the eyecup **B**, rotate it

anti-clockwise by 180° and re-attach it, you can also use it with your left eye.

For information on how to attach and remove the eyecup, refer to the Operating Instructions (PDF format).

- Keep the eyecup out of reach of children to prevent swallowing.

## About the Touch Menu

Touch ◀ (left side)/▶ (right side) of  on the Touch Menu to switch the operation icons.

- It is also possible to switch the operation icons by sliding the Touch Menu right or left while touching it.

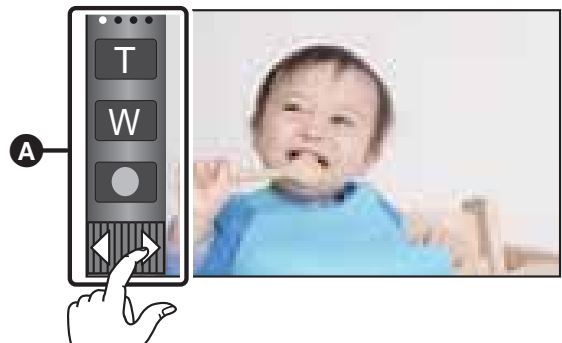

**A** Touch Menu

## ■ To display the Touch Menu

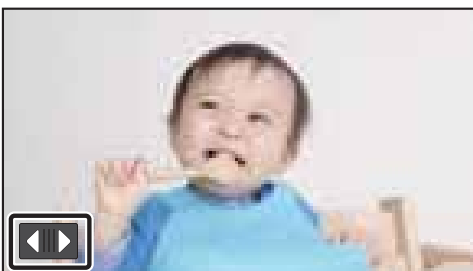

Display of the Touch Menu will disappear when no touch operation is performed for a specific period of time during recording of motion picture/still picture. To display it again, touch .

- Do not touch on the LCD monitor with hard pointed tips, such as ball point pens.

# Setting date and time

The clock is not set at the time of purchase. Make sure to set the clock.

- **When you turn on this unit, the message “Set home region and date/time.” may be displayed. Select [YES], and follow the steps below to make these settings:**
  - Step 2 of “Setting your home region for the first time”
  - Steps 2–3 of “Setting date and time”

## 1 Select the menu. (→ 29)

MENU : [SETUP] → [CLOCK SET]

## 2 Touch the date or time to be set, then set the desired value using ▲ / ▼ .

### A Displaying the World Time setting:

🏠 [HOME] / ✈️ [DESTINATION]

- The year can be set between 2000 and 2039.

## 3 Touch [ENTER].

- Touch [EXIT] to complete the setting.

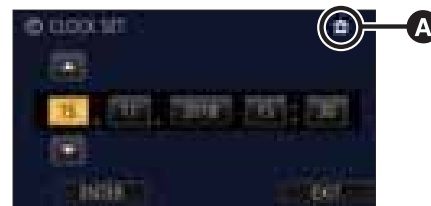

# Setting your home region for the first time

You can set your home region in [SET WORLD TIME].

## 1 Select the menu. (→ 29)

MENU : [SETUP] → [SET WORLD TIME]

- A message will be displayed. Touch [ENTER].

## 2 Touch ◀ / ▶ to select your home region and touch [ENTER].

- When the clock is not set, the current time is displayed as “--:--”.



- A The current time
- B The time difference from GMT (Greenwich Mean Time)

- For information on how to change your home region or set the region of your travel destination, refer to the Operating Instructions (PDF format).

## Selecting a media to record [WXF1M]

The card and built-in memory can be selected separately to record motion pictures or still pictures.

**1** Set this unit to Recording Mode. (→ 18)

**2** Select the menu. (→ 29)

MENU : [MEDIA SELECT]

**3** Touch the media to record motion pictures or still pictures.

- The media selected separately for motion pictures or still pictures is highlighted in yellow.

**4** Touch [ENTER].



## Changing the Recording Mode

**1** Touch the Recording Mode button icon.









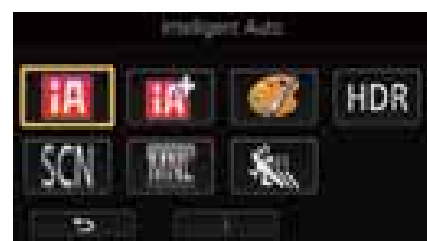
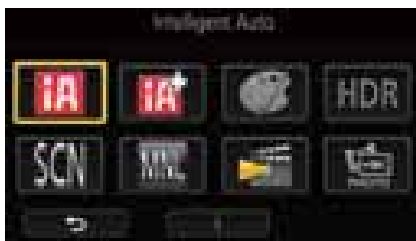



**2** Touch the desired Recording Mode button icon.

[WXF1] series/ [VXF1] series/ [VX1] series

[V800] series



Mode		Effect
 *1  *2 <b>Intelligent Auto</b>	You can switch the mode to the Intelligent Auto Mode, which optimises settings to the recording environment you are in.	
 *1  *2 <b>Intelligent Auto Plus</b>	You can add manually-adjusted brightness and colour balance settings to the Intelligent Auto Mode, and record.	
 *1 <b>Creative Control</b>	You can record motion pictures with added effects.	
<b>HDR</b> *1 <b>HDR Movie</b>	You can minimise the loss of gradations in bright areas and dark areas when, for example, the contrast between the background and the subject is large.	
<b>SCN</b> <b>Scene Mode</b>	This option allows this unit to automatically adjust the shutter speed and aperture, etc. according to the scene you want to record.	
 <b>Manual</b>	You can set the shutter speed, focus, White Balance, and brightness (iris/gain).	
 *1, 3 <b>Cinema Like Effect</b>	You can record images with cinematic effects.	
 *1, 4 <b>FULL HD Slow Motion Video</b>	You can record slow motion pictures.	
 *1, 3 <b>4K Photo</b>	You can record motion pictures optimised for capturing still pictures from 4K motion pictures.	
 *2 <b>Stop Motion Animation Assist</b>	You can set a recorded still picture as the background, and record the next picture while looking at that recorded picture as the background.	

\*1 In Motion Picture Recording Mode only

\*2 In Still Picture Recording Mode only

\*3 For the **WXF1** series/**VXF1** series/**VX1** series

\*4 **V800** series only





# Recording motion pictures

- 1 Open the LCD monitor or extend the viewfinder to switch to Motion Picture Recording Mode. (→ 19)
- 2 Press the recording start/stop button to start recording.

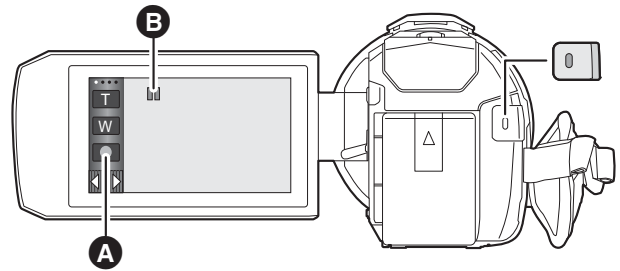

- A Recording button icon
- B When you begin recording, changes to .

- 3 Press the recording start/stop button again to pause recording.
  - Recording can also be started/stopped by touching the recording button icon.



# Recording still pictures

- 1 Open the LCD monitor or extend the viewfinder to switch to Still Picture Recording Mode. (→ 19)
- 2 Press the button halfway. (For Auto Focus only)

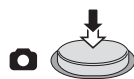

- 3 Press the button fully.

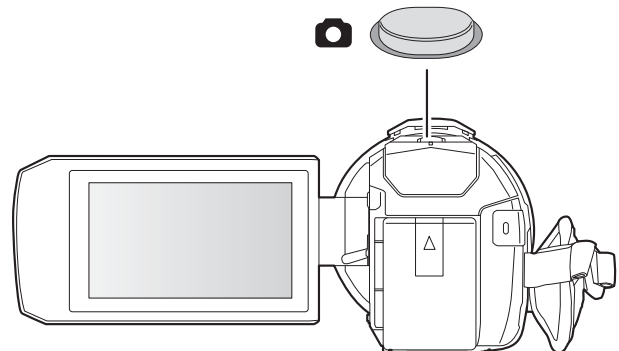

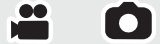

# Recording with the Sub Camera (Twin Camera) [WXF1] series

Using the Sub Camera and the Main Camera, you can record two images simultaneously. (Twin Camera)

Use the Sub Camera to enjoy recording yourself, a family member next to you or scenery different from that seen from the Main Camera.

## A Sub Camera

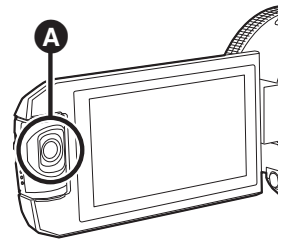

Recording a family member next to you

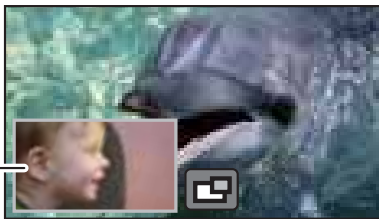

Recording scenery

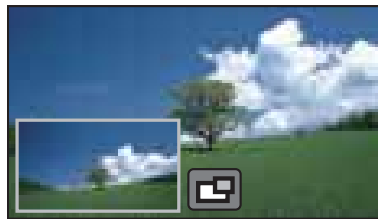

Recording yourself





## B Sub Window

- The image of the Sub Camera is displayed on the Sub Window.

- Recording only with the Sub Camera is not possible.
- An image recorded with the Main Camera and the Sub Camera's image displayed on the Sub Window are recorded as a single scene or still picture. When you play back such a scene or still picture, it is not possible to delete only the Sub Window image or hide it.
- The minimum focus distance of the Sub Camera is approximately 30 cm.

## 1 Rotate the Sub Camera.

- When you rotate the Sub camera from a position in the range **C** (0° to approximately 30°) to a position in the range **D** (approximately 30° to 270°), the Sub Window is displayed on the LCD monitor.
- If the Sub Window does not appear, touch  to display it.
- When the Sub Camera is in use, you cannot start up the Wireless Twin Camera function with  (startup icon for Wireless Twin Camera/disconnect icon for Wireless Twin/Multi-Camera).

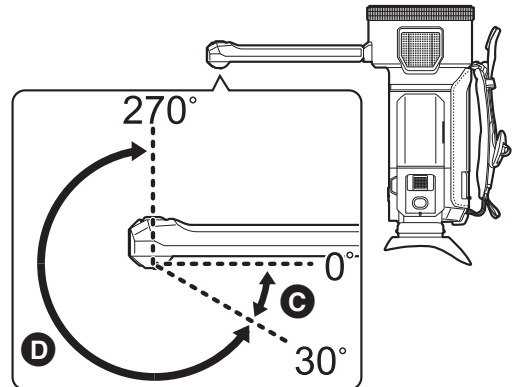

## 2 Start recording.

- Rotate the Sub Camera to the desired position.
- The Sub Camera works in Auto Focus, which adjusts focus automatically.
- Normally, hold this unit as shown in the illustration when recording.

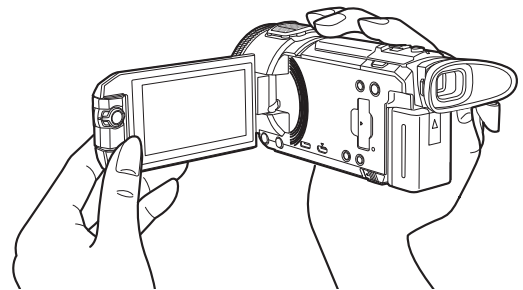

- When the LCD monitor is either closed or closed with the screen facing outward, the Sub Camera does not work. The Sub Window will be displayed if you open the LCD monitor again.

# Motion picture/Still picture playback



- 1 Set this unit to Playback Mode (→ 18).
- 2 Touch the media selection icon **A** to select the media you want to play. (→ 21)

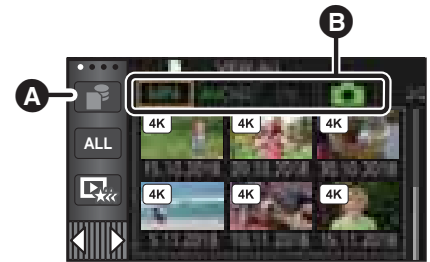

[Built-inMemory]<sup>\*1</sup>/[SD CARD]/[HDD]<sup>\*2</sup>

- (For the **WXF1** / **VXF1** / **VXF11** / **VX1** / **VX11** / **V800** / **V808**)  
Proceed to step 3 if a USB HDD is not connected.
- \*1 **WXF1M** only.
- \*2 Only displayed when a USB HDD is connected.

- 3 Touch the motion picture/still picture tab **B**.

**[MP4]:** 4K MP4<sup>\*3</sup> and MP4 scenes are displayed as thumbnails.

**[AVCHD]:** AVCHD scenes and scenes recorded with the Backup for Twin Camera function are displayed as thumbnails.

**[24p]:** 2160/24p<sup>\*3</sup> and 1080/24p scenes are displayed as thumbnails.

**[📷]:** Still pictures are displayed as thumbnails.

\*3 For the **WXF1** series/ **VXF1** series/ **VX1** series

- If there are recorded scenes/still pictures, the letters and icons on the motion picture/still picture tabs are displayed in green.
- The following icons are displayed on thumbnails when [MP4] is touched:
  - MP4 [2160/25p] scene: **4K** (For the **WXF1** series/ **VXF1** series/ **VX1** series)
  - MP4 [1080/50p] scene: **1080** (Blue) (Recording mode [1080/50M])  
**1080** (Recording mode [1080/28M])
  - MP4 [1080/25p] scene: **1080**
  - MP4 [720/25p] scene: **720**
  - MP4 [360/25p] scene: **360**
- The following icons are displayed on thumbnails when [AVCHD] is touched:
  - AVCHD [1080/50p] scene: **50p**
  - AVCHD [PH] scene: **PH**
  - AVCHD [HA] scene: **HA**
  - AVCHD [HG] scene: **HG**
  - AVCHD [HE] scene: **HE**
  - Scenes recorded with the Backup for Twin Camera function: **→**

- The following icons are displayed on thumbnails when [24p] is touched:

- MP4 [2160/24p] scene: **4K** (For the **WXF1** series/**VXF1** series/**VX1** series)
- MP4 [1080/24p] scene: **1080**

#### 4 Touch the scene or the still picture to be played back.

- To display the next (previous) page:
  - Slide the thumbnail display upward (downward) while touching it.
  - Switch the Touch Menu, and then touch ▲ (up) / ▼ (down) on the thumbnail scroll lever.



#### 5 Select the playback operation by touching the operation icon.

- Operation icons and screen display will disappear when no touch operation is performed for a specific period of time. To display them again, touch the screen.
- Touch ►/|| to start/pause playback of motion pictures.

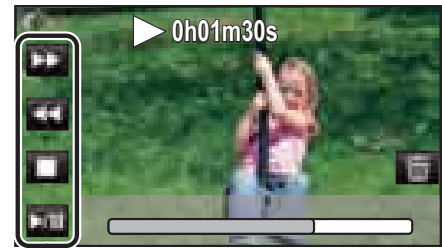

Operation icon

- The unit will restart if you switch to a different motion picture/still picture tab as below.
  - Switching from [24p]<sup>\*1</sup> to [MP4] or [AVCHD]
  - Switching from [MP4] or [AVCHD] to [24p]<sup>\*2</sup>

\*1 Including when you switched from [24p] to 📷 (still picture) first.

\*2 Including when you switched from [MP4] or [AVCHD] to 📷 (still picture) first.

- You can also select the media for playback through menu settings. [VIDEO SETUP] or [PHOTO SETUP] → [PLAY MEDIA SELECT]. (→ 29)

## Watching Video/Pictures on your TV



**Connect this unit to a TV using an HDMI micro cable (supplied).**

- Ⓐ HDMI micro connector [HDMI]
- Be sure to connect to the HDMI terminal. (Insert the connector with the arrow side facing up.)

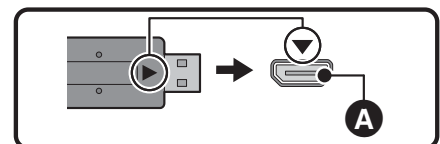

# Using the menu screen

- Touch ◀ (left side)/ ▶ (right side) of  on the Touch Menu to display  . (→ 21)

**1** Touch  .

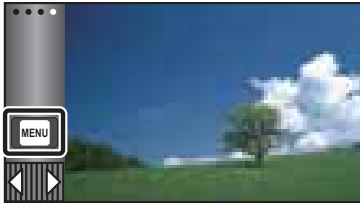

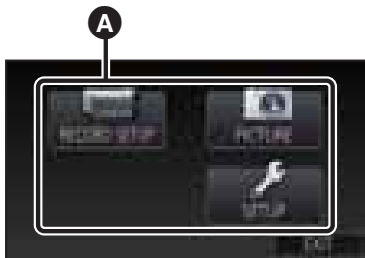

**2** Touch the top menu **A**.

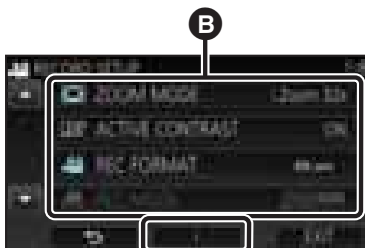

**3** Touch the submenu **B**.



- Next (previous) page is displayed by touching  / .

**4** Touch the desired item to enter the setting.

**5** Touch [EXIT] to exit the menu setting.

## ■ About guide display

After touching , touching the submenus and items will cause function descriptions and settings confirmation messages to appear.

- After the messages have been displayed, the guide display is cancelled.

## Language selection

You can select the language on the screen display and the menu screen.

 : [SETUP] → [LANGUAGE] →  
desired language

## Formatting







Please be aware that if a medium is formatted, then all the data recorded on the medium will be erased and cannot be restored. Back up important data on a PC, DVD disc etc.

 : [SETUP] → [FORMAT MEDIA] →  
desired media

[Built-inMemory]<sup>\*1</sup>/[SD CARD]/[HDD]<sup>\*2</sup>

\*1  only.

\*2 Displayed when connecting a USB HDD. (Refer to the Operating Instructions (PDF format))

-  /  /  /  /  /  
 / 

Media selection screen is not displayed when the USB HDD is not connected. Touch [YES].

- Do not format an SD card using any other equipment such as a PC. The card may not be used on this unit.

# What you can do with the Wi-Fi® function

This unit offers the following Wi-Fi functions when used in combination with another Wi-Fi compatible device.

<b>[TWIN CAMERA]</b>	You can display the image transmitted from a Wireless Sub Camera connected via Wi-Fi on this unit's Sub Window and record it simultaneously with the Main Camera's image. (→ 35)
<b>[Multi Camera]</b>	Connecting multiple smartphones to this unit via Wi-Fi allows you to simultaneously display two Sub Windows and record images in them. Up to three smartphones can be connected simultaneously.
<b>[Remote Ctrl]</b>	Using a smartphone, you can perform record/playback operations from a remote location or upload motion pictures and still pictures recorded in this unit on SNS (Social Networking Service). (→ 31)
<b>[Baby Monitor]</b>	You can use your smartphone to check on your baby being monitored by this unit when you are in another room. The smartphone and this unit can be used like radio transceivers, allowing the users to have a conversation by taking turns. This unit can also send a notification to the smartphone whenever the baby cries.
<b>[Hom.Monitor]</b>	You can confirm the recording screen of this unit from outside using a smartphone.
<b>[Live Cast]</b>	You can broadcast motion pictures of this unit live by setting up a link between the "LUMIX CLUB" and USTREAM.
<b>[DLNA Play]</b>	Connecting this unit to a DLNA (DMR) -compatible TV via Wi-Fi, you can play back scenes and still pictures on the TV.
<b>[Copy]</b>	By setting up a Wi-Fi communication between this unit and a PC, you can copy scenes and still pictures recorded with this unit to the PC.
<b>[History]</b>	Each use of a Wi-Fi function is stored in the Wi-Fi connection history. Connecting from the history allows you to easily set up a connection using the previous connection settings. <ul style="list-style-type: none"> <li>Records of Wi-Fi connections made with the Wireless Multi-Camera function are not saved.</li> </ul>

Before using any of these Wi-Fi functions, check the settings of your device and get it ready for use. These Basic Operating Instructions describe the procedure for using [Remote Ctrl] to provide a Wi-Fi connection example.

## ■ This unit is WPS-compatible

WPS (Wi-Fi Protected Setup™) is a function that allows you to easily set up a connection with a wireless LAN device and make security-related settings.

# [Remote Ctrl]

## ■ Before using [Remote Ctrl]

- You need to turn on the Wi-Fi function of your smartphone.
- Do not remove the SD card during remote operations.



### Caution:

Be sure to pay special attention to the privacy, the likeness rights, etc. of the subject when you use this function. Use at your own risk.

## Install the “Image App”

### About the “Image App”

The “Image App” is an application provided by Panasonic.

	For Android™ apps	For iOS apps
OS	Android 4.2 or later*	iOS 9.0 or later*
Installation procedure	<ol style="list-style-type: none"> <li>1 Connect your Android device to a network.</li> <li>2 Select “Google Play™ Store”.</li> <li>3 Enter “Panasonic Image App” into the search box.</li> <li>4 Select “Panasonic Image App” and install it.</li> </ol> <ul style="list-style-type: none"> <li>● The icon will be added to the menu. </li> </ul>	<ol style="list-style-type: none"> <li>1 Connect your iOS device to a network.</li> <li>2 Select “App Store”.</li> <li>3 Enter “Panasonic Image App” into the search box.</li> <li>4 Select “Panasonic Image App” and install it.</li> </ol> <ul style="list-style-type: none"> <li>● The icon will be added to the menu. </li> </ul>

\* The supported OS version are current as of January 2018 and subject to change.

- Use the latest version.
- Refer to [Help] in the “Image App” menu about how to operate.
- The service may not be able to be used properly depending on the type of smartphone being used. For information on the “Image App”, check the support website below.

[http://panasonic.jp/support/global/cs/e\\_cam](http://panasonic.jp/support/global/cs/e_cam)

(This Site is English only.)

- When downloading the app on a mobile network, high packet communication fees may be incurred depending on the details of your contract.

# Preparations before using [Remote Ctrl]

Install the “Image App”. (→ 31)

## Setting up a direct Wi-Fi connection between this unit and a smartphone



Setting up a direct connection between this unit and the smartphone when [Direct Connection Password] is set to [OFF] (→ 33)

- The default setting for [Direct Connection Password] is [OFF].

## Setting up a Wi-Fi connection via a wireless access point

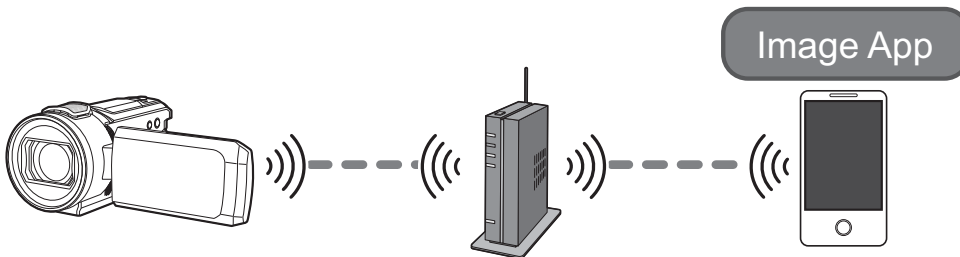

- 1 Check if the wireless access point is compatible with IEEE802.11b/g/n.
  - 2 Set up a Wi-Fi connection between this unit and the wireless access point.
- For information on how to connect this unit and a wireless access point, refer to the Operating Instructions (PDF format).



# Using [Remote Ctrl] with a direct connection

Setting up a direct connection between this unit and the smartphone when [Direct Connection Password] is set to [OFF]

**1** Press Wi-Fi button on this unit and touch [Wi-Fi Setup].

**2** Touch [Direct Connection].

- This unit will go into connection standby with the smartphone.
- The SSID of this unit is displayed on the screen of this unit.

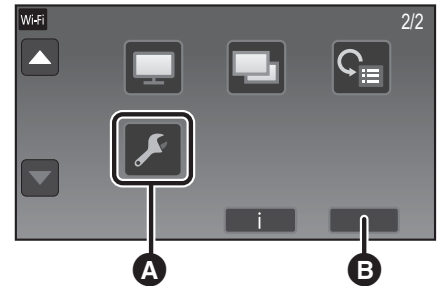

- A** [Wi-Fi Setup]
- B** [EXIT]

**3** Turn on the Wi-Fi function in the smartphone's setup menu.

**4** On the smartphone's Wi-Fi setting screen, select the SSID displayed on this unit.

- It may take time to complete the Wi-Fi connection.

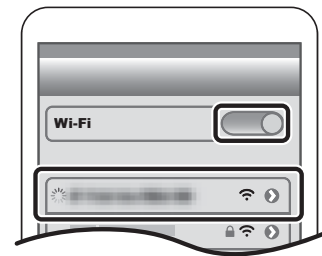

**5** When the Wi-Fi connection is complete, press the home button on the smartphone and start up the smartphone application "Image App".



**6** (If this is the first time the smartphone is connecting to this unit)  
Confirm the message "Connect this smartphone?", and touch [YES] on the screen of this unit.

- When the connection to this unit is complete, the image from this unit is displayed on the smartphone screen.  
Control this unit remotely with the smartphone.

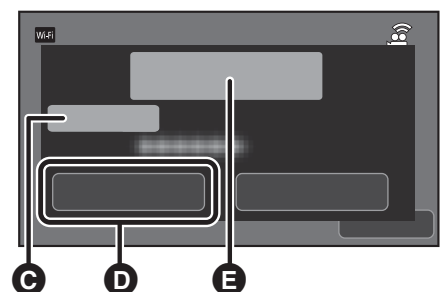

- C** [Device Name]
- D** [YES]
- E** Message

- Transmission speed may decrease, or may not be usable depending on the environment it is used in.
- For details on how to set up a connection with [Direct Connection Password] set to [ON], refer to the Operating Instructions (PDF format).
- If you cannot connect this unit and the smartphone, refer to the following:
  - Check the Wi-Fi settings of the smartphone to see if the SSID of this unit is selected so that a Wi-Fi connection will be made from the smartphone to this unit.
  - Make sure the smartphone is not connected to the wireless access point. If it is connected to the wireless access point, change the Wi-Fi access point using the smartphone's Wi-Fi set up.
- Please refer to the operating instruction of the device in use for details about the setting of the wireless access point or smartphone.

# About [Remote Ctrl]

## Screen display during remote operations

Smartphone screen shots are example displayed in Motion Picture Recording Mode and Playback Mode.

Recording screen	
	<ul style="list-style-type: none"> <li>① Recording media/remaining recordable time</li> <li>② Remaining battery power of this unit</li> <li>③ Zoom</li> <li>④ Photoshot button</li> <li>⑤ Menu display</li> <li>⑥ Playback mode button</li> <li>⑦ Remote control button</li> <li>⑧ Recording start/stop button</li> <li>⑨ Motion Picture Recording Mode/Still Picture Recording Mode toggle button</li> <li>⑩ Name of the connected device</li> </ul>
Playback screen	
	<ul style="list-style-type: none"> <li>① Camera function button</li> <li>② Number of scenes</li> <li>③ Remaining battery power of this unit</li> <li>④ Delete</li> <li>⑤ Upload</li> <li>⑥ Copy</li> <li>⑦ Name of the connected device</li> <li>⑧ Scene information display</li> </ul>

- Depending on your OS or the version of the smartphone application “Image App”, the screens may differ from the ones above.
- You cannot use [REC FORMAT] in the following ways in Recording Mode:
  - You cannot change the [REC FORMAT] setting or switch to Still Picture Recording Mode when [REC FORMAT] is set to [24p] in Recording Mode.
  - You cannot change the [REC FORMAT] setting from a setting other than [24p] to [24p].
- You cannot perform the following operations when switching between thumbnail screens in Playback Mode:
  - You cannot switch the recording format from [24p]<sup>\*1</sup> to an option other than [24p].
  - You cannot switch the recording format from an option other than [24p]<sup>\*2</sup> to [24p].

\*1 Including when the option is changed from [24p] to JPEG (Still picture).

\*2 Including when the option is changed from a recording format other than [24p] to JPEG (Still picture).

# Wireless Twin/Multi-Camera function

When this unit and one or more smartphones are connected via Wi-Fi, you can display the image transmitted from the smartphone on this unit's Sub Window and record it simultaneously with the Main Camera's image. (Wireless Twin/Multi-Camera)

- In these operating instructions, a function that displays an image from one smartphone in one Sub Window is referred to as "Wireless Twin Camera", and a function that displays images from up to three smartphones and the Sub Camera of this unit\* in two Sub Windows is referred to as "Wireless Multi-Camera".

\* For the **WXF1** series

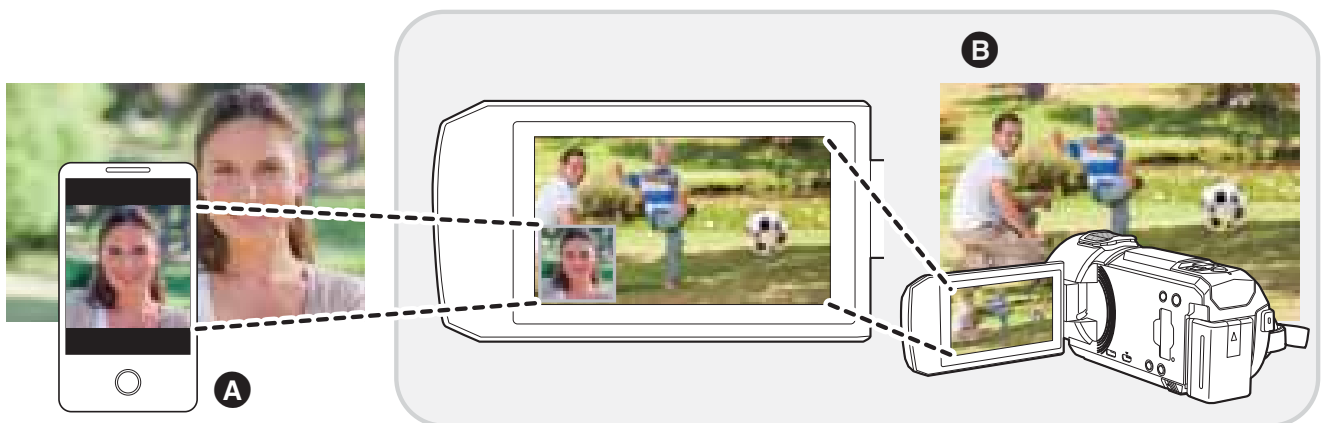

- A Smartphone (Wireless Sub Camera)
- B This unit (Main Camera)

Use your Wireless Sub Camera to enjoy recording your own face or any scenery different from what is being recorded with the Main Camera.

## ■ Wireless Twin Camera function

For information on non-smartphone devices that support the Wireless Sub Camera function and the procedures for using them, check the support website below. (As of January 2018)

[http://panasonic.jp/support/global/cs/e\\_cam](http://panasonic.jp/support/global/cs/e_cam)

## ■ Wireless Multi-Camera function (→ 30)



- For information on how to connect this unit and a smartphone and other details, refer to the Operating Instructions (PDF format).

# Troubleshooting

## ■ It is not a malfunction in following cases

<p><b>A clicking sound is heard when the unit is shaken.</b></p>	<ul style="list-style-type: none"> <li>● This is the sound of the lens moving and is not a defect. This sound will no longer be heard when the unit is turned on and set this unit to the Motion Picture Recording Mode or Still Picture Recording Mode.</li> </ul>
<p><b>Object seems to be warped.</b></p>	<ul style="list-style-type: none"> <li>● Object seems to be warped slightly when the object moves across the image very fast, but this is because the unit is using MOS for the image sensor. This is not a malfunction.</li> </ul>
<p><b>The lens, the viewfinder or LCD monitor fog up.</b></p>	<ul style="list-style-type: none"> <li>● This is due to condensation. It is not a malfunction. Please refer to page 6.</li> </ul>

Power	
Problem	Check points
<p><b>This unit cannot be turned on.</b></p> <p><b>This unit does not stay on long enough.</b></p> <p><b>Battery runs down quickly.</b></p>	<ul style="list-style-type: none"> <li>● Charge the battery again to ensure it is sufficiently charged. (→ 12)</li> <li>● In cold places, the battery using time becomes shorter.</li> <li>● The battery has a limited life. If the operating time is still too short even after the battery is fully charged, the battery has worn out and needs to be replaced.</li> </ul>
<p><b>This unit cannot be operated though it is turned on.</b></p> <p><b>This unit does not operate normally.</b></p>	<ul style="list-style-type: none"> <li>● Remove the battery or AC adaptor, wait about 1 minute and then reconnect the battery or AC adaptor. Then about 1 minute later, turn on the unit again. (Conducting the above operation while the media is being accessed may damage the data on the media.)</li> <li>● If normal operation is still not restored, detach the power connected, and consult the dealer who you purchased this unit from.</li> </ul>
<p><b>“ERROR OCCURRED. PLEASE TURN UNIT OFF, THEN TURN ON AGAIN.” is displayed.</b></p>	<ul style="list-style-type: none"> <li>● The unit has automatically detected an error. Restart the unit by turning the unit off and on.</li> <li>● The unit will be turned off in about 1 minute if the unit is not turned off and on.</li> <li>● Repair is needed if it is repeatedly displayed even if it is restarted. Detach the power connected, and consult the dealer who you purchased this unit from. Do not attempt to repair the unit by yourself.</li> </ul>

Recording	
Problem	Check points
<p><b>Colour or brightness of the image changes, or you may see horizontal bars in the image.</b></p> <p><b>The LCD monitor flickers indoors.</b></p>	<ul style="list-style-type: none"> <li>● Colour or brightness of the image may change, or you may see horizontal bars in the image when the object is recorded under fluorescent light, mercury light or sodium light, etc., but this is not a malfunction.</li> <li>● In Motion Picture Recording Mode, record in Intelligent Auto Mode/Intelligent Auto Plus Mode or set the shutter speed as follows: <ul style="list-style-type: none"> <li>– When [REC FORMAT] is set to [24p]: Set to 1/50 seconds in areas where the power supply frequency is 50 Hz, or 1/60 seconds in areas where the frequency is 60 Hz.</li> <li>– When [REC FORMAT] is set to a setting other than [24p]: Set to 1/100 seconds in areas where the power supply frequency is 50 Hz, or 1/125 seconds in areas where the frequency is 60 Hz.</li> </ul> </li> <li>● In Still Picture Recording Mode, this will not affect the recorded image.</li> <li>● In the following cases, setting the shutter speed to 1/100 seconds reduces the intensity of the problem: <ul style="list-style-type: none"> <li>– In FULL HD Slow Motion Mode</li> <li>– (For the <b>WXF1</b> series/<b>VXF1</b> series/<b>VX1</b> series) Slow &amp; Quick Video Mode</li> </ul> </li> </ul>

Playback	
Problem	Check points
<p><b>Scenes/still pictures cannot be played back.</b></p>	<ul style="list-style-type: none"> <li>● Any scenes/still pictures where the thumbnails are displayed as  cannot be played back.</li> </ul>

Please refer to “Operating Instructions (PDF format)” for details.

# Specifications

## 4K Video Camera/High Definition Video Camera

- \*1 When [REC FORMAT] is set to [4K MP4], or when [REC FORMAT] is set to [24p] with [REC MODE] set to [2160/24p]
- \*2 When [REC FORMAT] is set to [AVCHD] or [MP4]
- \*3 When [REC FORMAT] is set to [24p] with [REC MODE] set to [1080/24p]
- \*4 When Level Shot Function is set to normal or off

### Information for your safety

#### Power source:

- 5.0 V  $\equiv$  (When using AC adaptor)
- 3.6 V  $\equiv$  (When using battery)

#### Power consumption:

- WXF1** series  
Recording;  
6.1 W (When using the viewfinder)  
7.3 W (When using the LCD monitor)  
Charging; 7.7 W
- VXF1** series  
Recording;  
6.1 W (When using the viewfinder)  
6.6 W (When using the LCD monitor)  
Charging; 7.7 W
- VX1** series  
Recording; 6.4 W  
Charging; 7.7 W
- V800** series  
Recording; 6.2 W  
Charging; 7.7 W

#### Motion picture recording format:

- [4K MP4]<sup>\*</sup>, [MP4], [24p];  
MPEG-4 AVC file format compliant (.MP4)
- [AVCHD];  
AVCHD format version 2.0 compliant  
(AVCHD Progressive)
- \* **WXF1** series/**VXF1** series/**VX1** series

#### Motion picture compression:

MPEG-4 AVC/H.264

#### Audio compression:

[4K MP4]<sup>\*</sup>, [MP4], [24p];  
AAC/2 ch  
[AVCHD];  
Dolby Audio™ /5.1 ch (built-in  
microphone),  
2 ch (built-in microphone/external  
microphone)

\* **WXF1** series/**VXF1** series/**VX1** series

#### Recording mode and transfer rate:

##### [4K MP4]<sup>\*</sup>

[2160];  
Maximum 72 Mbps (VBR)

\* **WXF1** series/**VXF1** series/**VX1** series

##### [MP4]

[1080/50M];  
Maximum 50 Mbps (VBR)  
[1080/28M];  
Maximum 28 Mbps (VBR)  
[720];  
Average 9 Mbps (VBR)

##### [AVCHD]

[1080/50p];  
Maximum 28 Mbps (VBR)  
[PH];  
Maximum 24 Mbps (VBR)  
[HA];  
Average 17 Mbps (VBR)  
[HG];  
Average 13 Mbps (VBR)  
[HE];  
Average 5 Mbps (VBR)

##### [24p]

[2160/24p]<sup>\*</sup>;  
Maximum 72 Mbps (VBR)  
[1080/24p];  
Maximum 50 Mbps (VBR)

\* **WXF1** series/**VXF1** series/**VX1** series

Refer to the operating instructions (PDF format) for the picture size and recordable time of a motion picture.

**Still picture recording format:**

JPEG (Design rule for Camera File system, based on Exif 2.2 standard)  
Refer to the operating instructions (PDF format) for picture size of a still picture and number of recordable pictures.

**Recording media:**

SD Memory Card  
SDHC Memory Card  
SDXC Memory Card

Refer to page 15 for details on SD cards usable in this unit.

**WXF1M**

Built-in memory; 64 GB

**Image sensor:**

1/2.5 type (1/2.5") 1MOS image sensor

Total; 8570 K

Effective pixels;

Motion picture; 8290 K (16:9)<sup>\*1, 3</sup>,  
6170 K (16:9)<sup>\*2, 4</sup>

Still picture; 8290 K (16:9), 6220 K (4:3)

**Lens:**

Auto Iris, 24× optical zoom, F1.8 to F4.0

Focal length;

4.12 mm to 98.9 mm

(Full range AF)

35 mm equivalent;

Motion picture;

25 mm to 600 mm (16:9)<sup>\*1, 3, 4</sup>,

28.9 mm to 693.7 mm (16:9)<sup>\*2, 4</sup>

Still picture;

25 mm to 600 mm (16:9),

30.6 mm to 734.4 mm (4:3)

Minimum focus distance;

Normal; Approx. 10 cm (Wide)/

Approx. 1.2 m (Tele)

Intelligent Auto Macro;

Approx. 5 cm (Wide)

**Filter diameter:**

62 mm

**Zoom:**

24× optical zoom, 32×<sup>\*1</sup>/48×<sup>\*2, 3</sup> i.Zoom

**WXF1** / **WXF1M** / **VXF1** / **VX1** / **V800**

70×/1500× digital zoom

**VXF11** / **VX11** / **V808**

70×/250× digital zoom

**Image stabilizer function:**

Optical (Hybrid Optical Image Stabilizer,

Optical Image Stabilizer Lock function)

**Level Shot Function:**

Off/Normal/Strong

**Creative Control:**

[Miniature Effect]/[Silent movie]/

[8mm movie]/[Time Lapse Rec]

**HDR movie:**

Low/High

**Monitor:**

7.5 cm (3.0") wide LCD monitor (Approx. 460 K dots)

**Viewfinder (**WXF1** series/**VXF1** series):**

0.6 cm (0.24") wide EVF (Approx. 1550 K dots equivalent)

**Microphone:**

5.1 channel surround microphone/Zoom microphone/Focus microphone/Stereo microphone

**Minimum required illumination:**

Approx. 1.5 lx (1/25 with Low Light Mode in the Scene Mode)

Approx. 0.5 lx with the Night Mode ([COLOUR]) function

**WXF1** series/ **VXF1** series

0 lx with the Night Mode ([Infrared]) function

**HDMI micro connector video output level:**

HDMI™ (x.v.Colour™) 2160p\*/1080p/1080i/576p

\* **WXF1** series/ **VXF1** series/ **VX1** series

**Headphone output:**

85 mV, 32 Ω (Stereo mini jack)

**HDMI micro connector audio output level:**

[4K MP4]\*, [MP4], [24p];

Linear PCM

[AVCHD];

Dolby Audio/Linear PCM

\* **WXF1** series/ **VXF1** series/ **VX1** series

**MIC input:**

−60 dBV (Mic sensitivity −40 dB equivalent,

0 dB=1 V/Pa, 1 kHz)

Input impedance 5600 Ω

(Stereo mini jack)

**LINE input (**WXF1** series/**VXF1** series):**

−10 dBV (Stereo mini jack)

**USB:**

Reader function

SD card; Read only (No copyright protection support)

**WXF1M**

Built-in memory; Read only

Hi-Speed USB (USB 2.0), USB terminal

Type micro AB

USB host function (for USB HDD)

Battery charging function (Charges from

USB terminal when the main unit is off)



## Dimensions:

**WXF1** series/**VXF1** series

69 mm (W)×77 mm (H)×167 mm (D)  
(including projecting parts)

**VX1** series/**V800** series

68 mm (W)×77 mm (H)×142 mm (D)  
(including projecting parts)

## Mass:

**WXF1**

Approx. 458 g

[without battery (supplied) and an SD card  
(optional)]

**WXF1M**

Approx. 460 g

[without battery (supplied)]

**VXF1**/**VXF11**

Approx. 450 g

[without battery (supplied) and an SD card  
(optional)]

**VX1**/**VX11**/**V800**/**V808**

Approx. 428 g

[without battery (supplied) and an SD card  
(optional)]

## Mass in operation:

**WXF1**

Approx. 503 g

[with battery (supplied) and an SD card  
(optional)]

**WXF1M**

Approx. 503 g

[with battery (supplied)]

**VXF1**/**VXF11**

Approx. 495 g

[with battery (supplied) and an SD card  
(optional)]

**VX1**/**VX11**/**V800**/**V808**

Approx. 473 g

[with battery (supplied) and an SD card  
(optional)]

## Operating temperature:

0 °C to 40 °C

## Operating humidity:

10%RH to 80%RH

## Battery operation time:

See page 13

## Wireless transmitter:

Compliance standard; IEEE802.11b/g/n

Frequency range used;

Central frequency 2412 MHz to 2462 MHz [11ch]

Encryption method; Wi-Fi compliant WPA™/  
WPA2™/WEP

Access method; Infrastructure mode

## Sub Camera (**WXF1** series)

### Image sensor:

1/4 type (1/4") 1MOS image sensor

Total; 5270 K

### Lens:

F2.2

Focal length;

3.54 mm

35 mm equivalent (Motion picture);

37.2 mm

Minimum focus distance;

Approx. 30 cm

## AC adaptor

Information for your safety

### Power source:

110 V to 240 V ~, 50/60 Hz

### AC input:

0.25 A

### DC output:

5.0 V ==, 1.8 A

## Dimensions:

(VSK0815N)

66.4 mm (W)×72 mm (H)×46.3 mm (D)

(VSK0815K)

66.4 mm (W)×78.8 mm (H)×31 mm (D)

(VSK0815Q)

66.4 mm (W)×60.7 mm (H)×31 mm (D)

(VSK0815M)

66.4 mm (W)×66.8 mm (H)×31 mm (D)

## Mass:

(VSK0815N)

Approx. 70 g

(VSK0815K)

Approx. 65 g

(VSK0815Q)

Approx. 64 g

(VSK0815M)

Approx. 62 g

The symbols on this product (including the accessories) represent the following:

~	AC
==	DC
□	Class II equipment (The construction of the product is double-insulated.)
	ON
⏻	Standby



# About copyright

## ■ Carefully observe copyright laws

Recording of pre-recorded tapes or discs or other published or broadcast material for purposes other than your own private use may infringe copyright laws. Even for the purpose of private use, recording of certain material may be restricted.

## ■ Licenses

- SDXC Logo is a trademark of SD-3C, LLC.
- “AVCHD”, “AVCHD Progressive” and the “AVCHD Progressive” logo are trademarks of Panasonic Corporation and Sony Corporation.
- Dolby, Dolby Audio, and the double-D symbol are trademarks of Dolby Laboratories.
- The terms HDMI and HDMI High-Definition Multimedia Interface, and the HDMI Logo are trademarks or registered trademarks of HDMI Licensing Administrator, Inc. in the United States and other countries.
- x.v.Colour™ is a trademark.
- LEICA is a registered trademark of Leica Microsystems IR GmbH and DICOMAR is a registered trademark of Leica Camera AG.
- iMovie, Final Cut Pro, Mac, OS X and macOS are trademarks of Apple Inc. registered in the U.S. and other countries.
- App Store is a service mark of Apple Inc.
- Android and Google Play are trademarks or registered trademarks of Google Inc.
- The Wi-Fi CERTIFIED™ Logo is a certification mark of Wi-Fi Alliance®.
- The Wi-Fi Protected Setup™ Logo is a certification mark of Wi-Fi Alliance®.
- “Wi-Fi®” is a registered trademark of Wi-Fi Alliance®.
- “Wi-Fi Protected Setup™”, “WPA™”, and “WPA2™” are trademarks of Wi-Fi Alliance®.
- DLNA, the DLNA Logo and DLNA CERTIFIED are trademarks, service marks, or certification marks of the Digital Living Network Alliance.
- QR Code is a registered trademark of DENSO WAVE INCORPORATED.
- Other names of systems and products mentioned in these instructions are usually the registered trademarks or trademarks of the manufacturers who developed the system or product concerned.



This product is licensed under the AVC Patent Portfolio License for the personal use of a consumer or other uses in which it does not receive remuneration to (i) encode video in compliance with the AVC Standard (“AVC Video”) and/or (ii) decode AVC Video that was encoded by a consumer engaged in a personal activity and/or was obtained from a video provider licensed to provide AVC Video. No license is granted or shall be implied for any other use. Additional information may be obtained from MPEG LA, L.L.C.

See <http://www.mpegla.com>

This product incorporates the following software:

- (1) the software developed independently by or for Panasonic Corporation,
- (2) the software owned by third party and licensed to Panasonic Corporation,
- (3) the software licensed under the GNU General Public License, Version 2.0 (GPL V2.0),
- (4) the software licensed under the GNU LESSER General Public License, Version 2.1 (LGPL V2.1), and/or
- (5) open source software other than the software licensed under the GPL V2.0 and/or LGPL V2.1.

The software categorized as (3) - (5) are distributed in the hope that it will be useful, but WITHOUT ANY WARRANTY, without even the implied warranty of MERCHANTABILITY or FITNESS FOR A PARTICULAR PURPOSE. Refer to the detailed terms and conditions thereof, which can be displayed by following the procedure described in [SOFTWARE INFO] under “Using the Setup Menu” in the Operating Instructions (PDF format).

At least three (3) years from delivery of this product, Panasonic will give to any third party who contacts us at the contact information provided below, for a charge no more than our cost of physically performing source code distribution, a complete machine-readable copy of the corresponding source code covered under GPL V2.0 or LGPL V2.1, as well as the respective copyright notice thereof.

Contact Information: [oss-cd-request@gg.jp.panasonic.com](mailto:oss-cd-request@gg.jp.panasonic.com)

The source code and the copyright notice are also available for free in our website below.  
<https://panasonic.net/cns/oss/index.html>

# Limited Warranty (ONLY FOR AUSTRALIA)

## Panasonic Warranty

1. Subject to the conditions of this warranty Panasonic or its Authorised Service Centre will perform necessary service on the product, without charge for parts or labour, if in the opinion of Panasonic the product is found to have a manufacturing defect within one (1) year or (12 months) (the "warranty period") from the date of purchase appearing on your purchase receipt.
2. This warranty only applies to Panasonic products purchased in Australia and sold by Panasonic Australia, its Authorised Distributors, or Dealers, and only where the products are used and serviced within Australia or its territories. Warranty cover only applies to the services that are carried out by a Panasonic Authorised Service Centre and only if valid proof of purchase is presented when the warranty service is requested.
3. This warranty only applies if the product has been installed and/or used in accordance with the manufacturer's recommendations (as noted in the operating instructions) under normal use and reasonable care (in the opinion of Panasonic). The warranty does not cover damage, malfunction or failure resulting from use of incorrect voltages, incorrect installation, accident, misuse, neglect, build-up of dirt or dust, abuse, maladjustment of customer controls, mains supply problems, thunderstorm activity, infestation by insects or vermin, tampering or repair by unauthorised persons (including unauthorised alterations), exposure to abnormally corrosive conditions, or any foreign object or matter having entered the product.
4. This warranty does not cover the following items unless the fault or defect existed at the time of purchase:
  - (a) Consumable parts
  - (b) Cosmetic parts
  - (c) Worn or damaged parts
  - (d) Information stored on Hard Disk Drives, Optical Discs, USB Devices, SD Cards, Tapes
  - (e) DTV reception issues caused by TV Aerial / Cabling / Wall socket(s)
5. Some products may be supplied with Ethernet connection hardware. The warranty is limited on such products and will not cover:
  - (a) Internet and or DLNA connection / setup related problems
  - (b) Access fees and or charges incurred for internet connection
  - (c) Incompatible software or software not specifically stipulated in the product operations manual; and
  - (d) Any indirect or consequential costs associated with the incorrect use or misuse of the hardware, its connection to the internet or any other device.
6. To claim warranty service, when required, you should:
  - Contact Panasonic's Customer Care Centre on 132 600 for Service Centre information.
  - Confirm the opening and acceptance times with the Authorised Service centre that you choose.
  - Then send or take the product to a Panasonic Authorised Service Centre together with your proof of purchase receipt.
  - Any freight and insurance costs associated with the transport of the product to and/or from your nearest Authorised Service Centre must be arranged and paid for by you.
7. The warranties hereby conferred do not extend to, and exclude, any costs associated with the installation, de-installation or re-installation of a product, including costs related to the mounting, de-mounting or remounting of any screen, (and any other ancillary activities), delivery, handling, freighting, transportation or insurance of the product or any part thereof or replacement of and do not extend to, and exclude, any damage or loss occurring by reason of, during, associated with, or related to such installation, de-installation, re-installation or transit.

Panasonic Authorised Service Centres are located in major metropolitan areas and most regional centres of Australia, however, coverage will vary dependant on product. For advice on exact Authorised Service Centre locations for your product, please telephone our Customer Care Centre on 132600 or visit our website and use the Service Centre Locator.

In addition to your rights under this warranty, Panasonic products come with consumer guarantees that cannot be excluded under the Australian Consumer Law. If there is a major failure with the product, you can reject the product and elect to have a refund or to have the product replaced or if you wish you may elect to keep the goods and be compensated for the drop in value of the goods. You are also entitled to have the product repaired or replaced if the product fails to be of acceptable quality and the failure does not amount to a major failure.

If there is a major failure in regard to the product which cannot be remedied then you must notify us within a reasonable period by contacting the Panasonic Customer Care Centre. If the failure in the product is not a major failure then Panasonic may choose to repair or replace the product and will do so in a reasonable period of time from receiving notice from you.

**THIS WARRANTY CARD AND THE PURCHASE DOCKET (OR SIMILAR PROOF OF PURCHASE) SHOULD BE RETAINED BY THE CUSTOMER AT ALL TIMES**

If you require assistance regarding warranty conditions or any other enquiries, please visit the Panasonic Australia website [www.panasonic.com.au](http://www.panasonic.com.au) or contact by phone on **132 600**  
*If phoning in, please ensure you have your operating instructions available.*

**Panasonic Australia Pty. Limited**

ACN 001 592 187 ABN 83 001 592 187  
 1 Innovation Road, Macquarie Park NSW 2113  
[www.panasonic.com.au](http://www.panasonic.com.au)

**Panasonic Corporation**  
Web site: <http://www.panasonic.com>

© Panasonic Corporation 2018

DVQX1456ZA