



Panasonic®

Operating Instructions Refrigerator

For Household Use

Model No: NR-BX41BX, NR-BX41BV
NR-BX46BX, NR-BX46BV



NR-BX41BX
NR-BX46BX

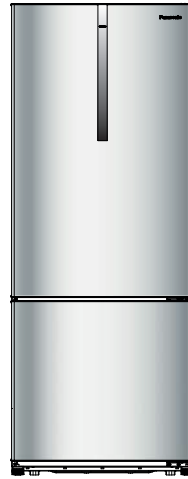

NR-BX41BV
NR-BX46BV

Contents

• Safety precautions	2
• Required action	4
• Installation	5
• Parts identification	6
• Temperature control	7
• Temperature control (Fine adjustment mode)	8
• Quick freezing	8
• ECONAVI operation	9
• Food storage in the freezer compartment	9
• How to clean the refrigerator	10
• Troubleshooting	11
• Specifications	back cover

Thank you for purchasing the Panasonic product.

- Please read these instructions carefully and follow safety precautions page 2-3 before using this product.
- Please make sure the date and name of store of purchase are stamped in warranty card and keep it with this operating instructions.

AU

AK-174150
P0915-0
Printed in Thailand

Safety precautions

Please be sure to follow these instructions.



WARNING

This sign means
[It may lead a serious injury or death.]



CAUTION

This sign means
[It may result in injury or property damage.]



These signs mean prohibited action.



This sign means required action.



This sign means the appliance must be earthed to prevent electric shock.



R600a
iso-butane

Otherwise it may cause
a fire, injury, explosion,
electrical shock.



WARNING

When using...



- **Do not** damage the cooling circuit (piping on the back.) The flammable refrigerant may catch fire and lead to an explosion.
- **Do not** touch compressor or pipe, this area is high temperature.
- **Do not** let any children hang the refrigerator's door, it may overturn to the kid.
- **Do not** place any water container on the top of the refrigerator.
- **Do not** fill the gaps around the refrigerator. (If the refrigerant leaks, then it may catch fire.)

For power plug and cord...



- **Do not** plug or unplug with wet hands.
- **Do not** let the cord or plug be damaged. If the supply cord is damaged, must be replaced by service center.

When installing...



- Ensure that the refrigerator is plugged into an earthed mains socket. Do not plug into an unearthed mains socket.

In case of emergency...



- **Do not** use electrical appliances such as a deodorizer in the refrigerator. (If the refrigerant leaks, then it may catch fire due to sparks on the contacts.)
- **Do not** store explosive appliances such as aerosol cans with a flammable propellant and chemicals or scientific specimens in this appliance.



- **Do not** disassemble, repair or modify the refrigerator by yourself. If you want to repair the refrigerator, please consult your dealer or authorized service center.



- **Do not** use mechanical device or other means to accelerate the defrosting process, other than those recommended by the manufacturer.

When storing food...



- **Do not** add a high impact on glass trays. (Otherwise those glass trays may break and you may be injured.)
- **Do not** freeze glass bottles. (If the liquid in a glass bottle is frozen, then the bottle may break and the liquid may leak out.)



Safety precautions

Please be sure to follow these instructions.

Otherwise it may cause burn injury accidents.



CAUTION

When moving the refrigerator...



- Hold the refrigerator tightly when transporting.
- Apply protective covering, etc. to floors with a fragile surface.
- During transportation and installation, ensure that the tubing of the refrigerant circuit is not damaged.
- Leaking refrigerant can ignite and may damage the eyes.



In case of emergency...



- **Stop** using the refrigerator immediately if there is an abnormality or failure. (Otherwise it may cause smoke, a fire or electrical shock.)
Abnormality and failure examples.
 - Power cord or plug is abnormally hot.
 - Power cord is deeply cut or deformed.
 - There is burning smell.
 - You can feel tingling electricity.
- A flammable refrigerant is used. If you have damaged the cooling circuit (piping), open the windows to ventilate the kitchen and contact your dealer. (Otherwise it may cause an electrical shock, ignition or explosion.)

When installing the product...



- For safety and efficiency in high operation, it should be checked that the ground connection system in the house has been installed correctly.

When using...



- This appliance is not intended for use by persons (including children) with reduced physical, sensory or mental capabilities, or lack of experience and knowledge, unless they have been given supervision or instruction concerning use of the appliance by a person responsible for their safety.
- Children should be supervised to ensure that they do not play with the appliance.
- Maintenance work only be carried out at workshop by well-trained maintenance worker.
- Servicing personal in Queensland are hereby advised that Queensland installation/servicing requirements must be followed, including the need for a Gas Work Authorisation (hydrocarbon refrigerant), if the gas system of this appliance is opened or charged.

For power plug and cord...



- Disconnect power plug when cleaning.
- Plug into a wall outlet of the rated voltage on its own with the rated current and insert plug full.
- Reserve one plug for the refrigerator only. Avoid connecting many appliances to the same plug and unroll through the length of cord.
- Remove dust periodically from the power plug.
- If you detect a gas leak, do not touch the power plug and ventilate the kitchen.
- If you detect burning smell, disconnect the power plug and ventilate the kitchen.

When recycling the product...



- Before taking the refrigerator to be recycled, please remove all the door opening seal to prevent locking a child in it.
- The warning labels mentioned above should be kept throughout the life of the refrigerator.
The user manual should be handed over to any person who would use or handle the refrigerator whenever the refrigerator would be transferred to another location and delivered to a recycling plant.
- Regarding to local laws, Cyclo-Pentane is used for insulation of this refrigerator and flammable gas is used for refrigerant. When you throw away this unit, please discard it by proper method and do not dispose it by burning.

When opening/closing the doors...



- While opening the refrigerator, be careful not to pinch other one's hand holding the door.
- Mind the gap between the doors. They may nip your hand while closing the door.

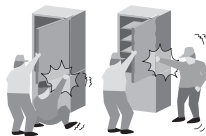

Required action

When opening/closing the doors...

- **Do not** refrigerate items which are bigger than tray or shelf, as the door will not close completely causing leakage of cool air.
- **Do not** open refrigerator frequently or leave it open for long time in order to prevent water dripping inside and waste energy.
- Frequently check the door opening seal, it must be closed to the refrigerator's body completely.

When cleaning...

- **Do not** clean the refrigerator with chemical substance or liquid. It will cause damage and have corrosion on the surface.
- Clean the pan water evap located over the compressor at the back of the refrigerator every three months to prevent the odour generated from humidity.
- Be cautious of hot copper pipe inside pan water evap when removing it.



When using...

- When the plug is disconnected, leave it for 10 minutes before plugging again. If not, the compressor may not work.
- **Do not** put anything on top of the refrigerator. Otherwise, it may fall due to vibration.
- Adjust the temperature according to the actual operating condition for energy saving.
- If you will not be at home for several days and there are nothing refrigerated in the refrigerator, the plug should be disconnected for energy saving.



When storing food...

- **Do not** place warm/hot foodstuff in the refrigerator. Store warm food and drinks after they have cooled.
- **Do not** overload the refrigerator. Gap must be provided between foodstuffs to maintain the cooling effect.
- Store fruits and vegetables in vegetable case, where trapped moisture helps preserve food quality for longer time periods.
- Drinking water, beverage bottles should be sealed to prevent the odour.
- Foodstuff such as vegetable, fruits and fresh food should be wrapped or pack in box before freezing and refrigerating.
- Put the food such as meat or fish in the freezer if you want to store for an extended period.
- If you will put high moisture content into refrigerator, should be sealed and wrapped to prevent dew and frost.
- It is suitable for storage food and so on which would like to storage another food separately.



Installation

The distance from the wall is installed

- The top of the refrigerator and the ceiling at least 30 cm.
- The wall and the back of the refrigerator at least 10 cm.
- The side of the refrigerator and the wall at least 5 cm.

Area around installed

- The room for installing the appliance must be at least 1 cubic metre per 8 grams of refrigerant. The refrigerant quantity contained in this appliance is noted on the Rating Plate of the appliance.
- **Do not** locate the refrigerator in a humid place as rust may form and may cause electric leakage.
- **Do not** locate the refrigerator exposing to direct sunlight as the heat and sunlight will increase the temperature.
- **Do not** locate the refrigerator near heat source such as cooking stove or oven.
- **Do not** block the openings on the circumstances of the refrigerator.
- The refrigerator must be located in the place where there is good air circulation.
- In case of placing the refrigerator on an uneven surface, adjust the adjustable bolt to make the refrigerator stands stably.

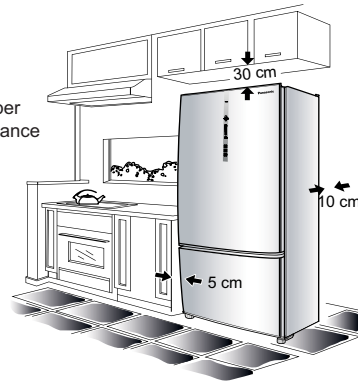

Moving or shifting

- When moving or shifting the refrigerator, remove ice twister, pan water evap etc. and check to be sure that there is no water in the refrigerator, adjust the adjustable bolt of refrigerator, then move the refrigerator and install in the location, adjust adjustable bolt for locking.

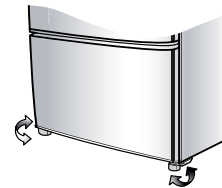

Power cord setting

- To bring power cord for use, pan water evap from left should be lifted up. Then bring the power cord out and then insert pan water evap into the block by pressing at both the sides.

LED lamp and Grounding

- The refrigerator LED lamp, specially designed for this refrigerator, does not function on individual replacing. If you need replacement, please contact Panasonic Service Center.
- If there is no grounding wiring plug in refrigerator, it should be connected with grounding connection or prevent electrical hazard from electric leakage.

For safety, the ground connection should be done

(For a refrigerator with plug (2-pin plug) without any ground wire)

The ground connection will allow prevention of danger resulted from electricity leakage.

The ground connection can be performed in 2 ways as follows:

1. In the case that the grounding receptacle having been prepared for the socket (plug socket), connect the ground wire to the screw used for ground connection at the bottom rear of the refrigerator (regarding the screw used for ground connection, please notice the ⚡ symbol) as shown in the illustration 1 .
2. In the case that the socket (plug socket) having not been provided with any grounding receptacle, connect the ground wire to the screw at the bottom of the refrigerator, (as regards the screw used for ground connection, please notice the ⚡ symbol). And then connect the other end to the ground rod as shown in the illustration 2 .

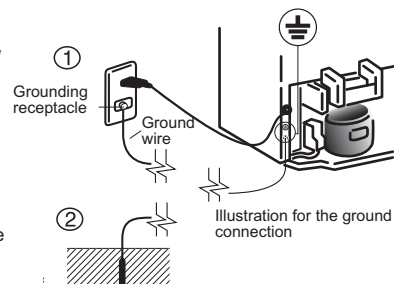

Prohibited spots for ground connection

- Gas pipes and water supply pipes (dangers from electric shock or explosion).
- The ground wires of telephone cords and lightning rods (dangers from lightning).

Parts identification

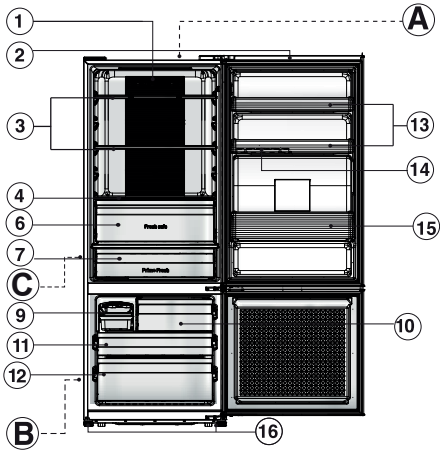

NR-BX41BX, NR-BX46BX

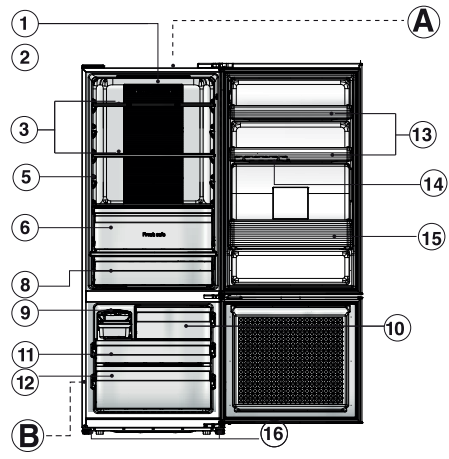

NR-BX41BV, NR-BX46BV

- A FRIDGE ROOM
- B FREEZER ROOM
- C PRIME FRESH ROOM
- 1 LED lamp
- 2 Control Panel (Model: NR-BX41BX, NR-BX46BX)
- 3 PC Glass tray
- 4 Glass tray crispener
- 5 Control Panel (Model: NR-BX41BV, NR-BX46BV)
- 6 Vegetable case
- 7 Prime Fresh Case
- 8 Chilled case
- 9 Ice twister
- 10 Top freezer case
- 11 Middle freezer case
- 12 Bottom freezer case
- 13 Egg shelf
- 14 Egg tray
- 15 Bottle shelf
- 16 Adjustable bolt
- 17 Pan water evap
- 18 Compressor

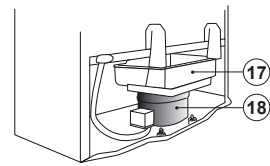













Product view from behind.



SPECIAL FEATURE

- 1) **NON-FLON**
This unit uses totally NON-FLON MATERIALS both for refrigerant (iso-butane (R600a)) and for insulation (Cyclo-Pentane). So, this refrigerator does not damage the earth's ozone layer and has almost no effect on global warming.
- 2) **INVERTER**
In accordance with temperature change inside the compartment, the motor runs at different speed. When the temperature is stable, the motor runs at a lower speed (energy saving & lower noise). When powerful cooling is required, the motor runs at a higher speed.

Temperature control (Model: NR-BX41BX, NR-BX46BX)

 <p>The temperature can be adjusted for Min - Max levels. Press  or  to adjust temperature in Freezer, Fridge or Prime Fresh room respectively.</p>	"Fridge"		Lower than Med by 3°C ~ 6°C
			Approx. 0.5°C ~ 5.5°C
			Higher than Med by 2°C ~ 8°C
	"Prime Fresh"		Lower than Med by 1°C ~ 4°C
			Approx. -4.5°C ~ -1.5°C
			Higher than Med by 1°C ~ 4°C
	"Freezer"		Higher than Med by approx. 4.2°C
			Lower than Med by 3°C ~ 7°C
			Approx. -22.5°C ~ -17.5°C
			Higher than Med by 1°C ~ 9°C

Temperature control (Model: NR-BX41BV, NR-BX46BV)

The temperature can be adjusted for Min-Max levels. Press  to adjust temperature in Fridge Room and press  to adjust temperature in Freezer Room.

Fridge Room temperature control

"Max" Lower than Med by 3°C ~ 6°C	
"Med" Approx. 0.5°C ~ 5.5°C	
"Min" Higher than Med by 2°C ~ 8°C	

Freezer Room temperature control

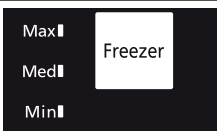
"Max" Lower than Med by 3°C ~ 7°C	
"Med" Approx. -22.5°C ~ -17.5°C	
"Min" Higher than Med by 1°C ~ 9°C	

Temperature in Chill case is automatically set at approximately -1.5°C ~ -3.5°C

Remark

While operating the refrigerator for the first time, after connecting the plug, adjust the temperature to "Med" position of each control and leave it for 24 hours for the effective cooling operation. After that, adjust the temperature as you prefer. If you want to save the energy, do not adjust the temperature lower than the actual operating condition.

Temperature control (Fine adjustment mode)

This refrigerator is specially designed for appropriate use, which can adjust the temperature level to detailed 9 levels with the following details.

How to operate the “9 levels” mode

For the freezer room

1. Set LED display to “Min” with the “Freezer” button.
2. Press and hold the “Freezer” button (for a few seconds) until the LED display return to show at “Min” position.
3. Set “9 levels” mode following below table mentioned by pressing the “Freezer” button.

LED Display table (Model: NR-BX41BX, NR-BX46BX)

Cooling Level	Minimum Maximum								
Step	1	2	3	4	5	6	7	8	9
LED DISPLAY									

Lighting
 Blinking
 Not lighting

LED Display table (Model: NR-BX41BV, NR-BX46BV)

Cooling Level	Minimum Maximum								
Step	1	2	3	4	5	6	7	8	9
LED DISPLAY									

Lighting
 Blinking
 Not lighting

For the Fridge Room

Operate above 1 ~ 3 steps with pressing “Fridge” button instead of “Freezer” button.

To reset the setting “9 levels” mode

Repeat step 1 and 2, then the refrigerator return to normal operation mode.

Remark:

Temperature control varies depends on the changing of environment and food storage quantity.

Quick freezing

How to operate the “Quick Freezing” mode

- Press the button “Freezer” until Blue light LED turns on. “Quick Freezing” mode starts after 10 seconds.
- The system will stop operating automatically when it runs for 120 mins (as ambient temperature is below 25C) or 150 mins (as ambient temperature is above 25C) and return to normal mode (Blue light LED turns off.)

Remarks :

- If you want to stop the operation immediately, press the button “Freezer” until Blue light LED turns off.
- Blue light LED flashing means that the defrosting system is now working “Quick Freezing” mode will start right after the defrosting operation is finished.
- Freezer temp. control does not operate during “Quick Freezing” mode.

ECONAVI operation

Model : NR-BX41BX, NR-BX46BX

Detect opening and closing of door and brightness around refrigerator, and automatically controls operation to save energy¹.

ECONAVI lamp is on during ECONAVI operation

- This refrigerator learn the lifestyle patterns of your family from opening and the time periods of infrequent use to perform ECONAVI operation.

Remark :

- The refrigerator learns your lifestyle pattern from the previous 3 weeks, and uses what it has learned from the 4th week onwards. Therefore, the ECONAVI lamp "ON/OFF" pattern may change from the 4th week onwards.
- The refrigerator performs ECONAVI operation when it becomes dark² around the refrigerator, such as when you are asleep.
- The brightness of the lamp is lowered approximately 5 minutes after the lamp turns on.

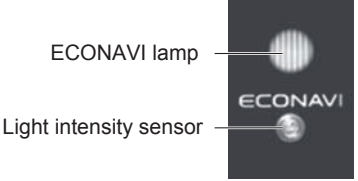

Setting for enabling ECONAVI operation

- ECONAVI operation is enabled automatically only when the temperature control of the freezer compartment are set to "Med". (However, ECONAVI does not operate while quick freezing is operating.)
- It is not possible to forcefully start ECONAVI operation.

Model : NR-BX41BV, NR-BX46BV

This model does not feature ECONAVI lamp and light intensity sensor, so it only uses the lifestyle patterns of the family to operate ECONAVI mode.

Remark :

- ¹ Effectiveness differs depending on the ambient temperature, ambient brightness, number of times and when doors are opened and closed, and state in which food is stored.
- ² Darkness is detected by the light intensity sensor at approximately 3 lx to 10 lx or less

Food storage in the freezer compartment

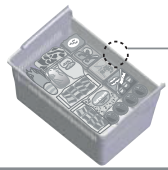

Bottom Freezer Case

Maximum Storage

If the stored food exceeds edge of container, the freezer door can not close completely and the compartment may become frosted.

How to make ice cubes

Please use only the drinking water for ice making.

1. Pull out the ice twister.
2. Fill water in the ice twister until the water level line, then place it back.
3. To remove ice cubes
 - 1) Be sure to put in a top freezer case inside.
 - 2) Twist the ice twister clockwise.(The ice cubes will drop into the ice freezer case.)

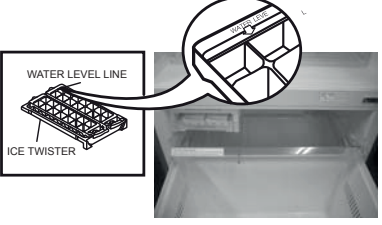

Remark

- If an ice twister is twisted while top freezer case pulled out, ice and water will fall inside or floor^f. Please be sure to put in a top freezer case to receive the falling ice.

Usage tips

- Fridge Room** For regular storage of food and drinks or temporary storage of those to be served soon.
- Freezer Room** For storage of frozen or dried foods.
- Prime Fresh Case** For storage of fresh food such as meat or fish.
- Chill Case** For processed food or dairy products



How to clean the refrigerator

- 1 Interior cleaning**
Wipe off the stain with warm water. When stains can not be removed easily, wipe them with warm water and soap by using a soft cloth. Then wipe the soap off using damp soft cloth.
- 2 Exterior cleaning**
Cleaning by using soft cloth with warm water and soap. Then wipe off the soap.
- 3 Gasket door PC**
 - Clean by wiping softly. This area, petroleum gel was applied to reduce the friction of the refrigerator body. Be careful not to wipe off them.
 - The door opening seal is replaceable when reaching end of life. While cleaning, push it back to the groove if it comes off.

Use lukewarm water!



Note: Do not use the following items. (Otherwise, the surface will be scratched.)

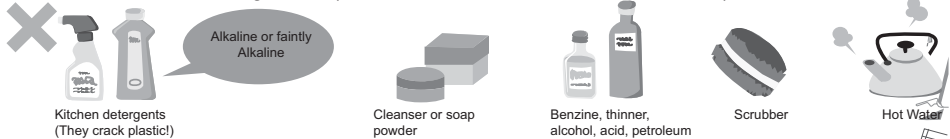

Removing trays for cleaning.

- **Removing**
 1. Unhook the protrusion at the back by lift it upward and pull the tray forward until removing.
- **Attaching**
 2. Push the tray until it reached the end lock.

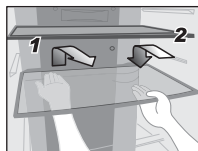

Remark

- When removing tray above vegetable case, please pull out the vegetable case first and then follow to removing the tray as above details.
- In case of attaching the tray and it does not lock, make sure that you did not attach it the wrong tray.
- Make sure that you don't attach the upper side of the tray downward.
- Two PC Glass trays can be used alternately, but Glass tray crisper should only be attached right above crisper case.

Removing the freezer case, vegetable case and chilled case for cleaning.

- **Removing**
 1. Pull the case until it reached the end of stopper
 2. Raise up the front of case a bit and then completely take out.
- **Attaching**
 1. Push the case on both supporters.
 2. Raise it up, then push until it reached the end.

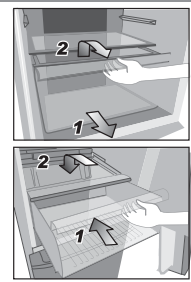

Removing egg shelf, bottle shelf for cleaning.

- **Removing**
 1. Lift it upward, alternating between the right and left side.
- **Attaching**
 2. Placing it on both supporters, and then press until it reached the end of supporters.

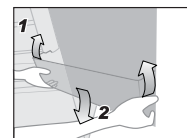

Troubleshooting

<p>The refrigerator does not operate.</p>	<ul style="list-style-type: none"> • Check that the plug and its socket are in good condition. • Check if there is any problem on main fuse and electrical system of the house. • Check by unplug and wait for 10 minutes before plugging it back in. 	
<p>The refrigerator does not cool enough.</p>	<ul style="list-style-type: none"> • Check to be sure that the temperature control button or lever is at the proper position. • Check to see if the refrigerator is overloaded with stuff or there is any hot foodstuff refrigerated inside. • Is the refrigerator exposed directly to sunlight or heat source? • Is the refrigerator door completely closed? • Is the refrigerator door opened frequently? 	
<p>Vapor generated inside and outside the cabinet / surface of door.</p>	<ul style="list-style-type: none"> • Condensation may appear on the surface of cabinet when humidity is high, e.g. during rainy season or the air circulation is not good. • If there is condensation inside, check if the door is completely closed. Is the refrigerator frequently opened or left open for a long time? Is there any hot foodstuff refrigerated inside? 	
<p>The refrigerator generates noise.</p>	<ul style="list-style-type: none"> • Check if the refrigerator is located on a stable floor or is installed properly. • Check if there is any object in contact with the refrigerator. 	
<p>Food becomes frozen</p>	<ul style="list-style-type: none"> • Do you put the food near cold air duct? • Do you adjust the temperature control at "MAX"? Adjust to "MIN". • Do you put food in chilled case? 	
<p style="writing-mode: vertical-rl; transform: rotate(180deg);">The ECONAVI lamp does not light properly.</p>	<p>ECONAVI does not operate. (the ECONAVI lamp does not light)</p>	<ul style="list-style-type: none"> • Is the quick freezing operating? • Are the temperature setting of freezer compartment set to something other than "MED" ? • Did you open the doors frequently, or store very hot food? • The learning function may automatically disable ECO NAVI operation during times of frequent use.
	<p>ECONAVI operation is rarely performed.</p>	<ul style="list-style-type: none"> • Is there a power failure? If a power failure occurs, the leaning function data collected up until that will be lost. ECO NAVI operation will rarely be performed until the learning function has collected the data again.
	<p>ECONAVI operation is stopped part way though.</p>	<ul style="list-style-type: none"> • If for example, defrosting (auto) is turned on during ECO NAVI operation, the normal cooling operation will need to be performed afterwards so ECO NAVI operation may be stopped. • The learning function may be sometimes restart the normal cooling operation.
	<p>ECONAVI operation is performed too often (the ECONAVI lamp rarely turns off).</p>	<ul style="list-style-type: none"> • Is the light intensity sensor hidden? • Is there dirt scratches on the control panel (light intensity section)? • ECO NAVI operation may be performed while the refrigerator is being used depending on the conditions of use, but the cooling performance is maintained. 