

# Dimensions

## 1 Indoor Unit and Remote Control

<Top View>

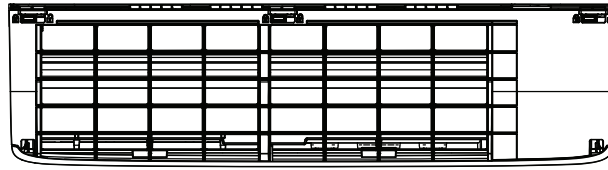

<Side View>

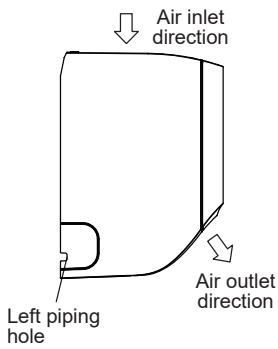

<Front View>

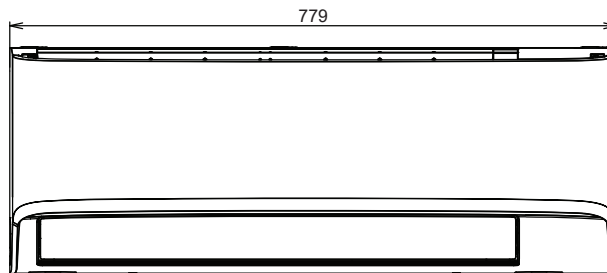

<Side View>

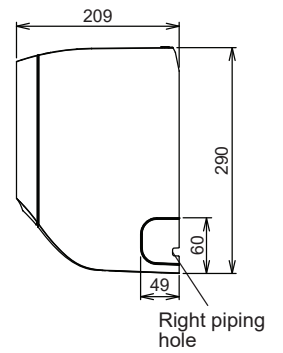

<Bottom View>

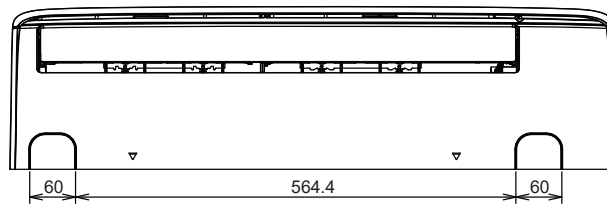

<Remote Control>

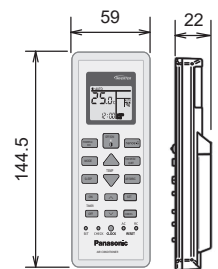

<Rear View>

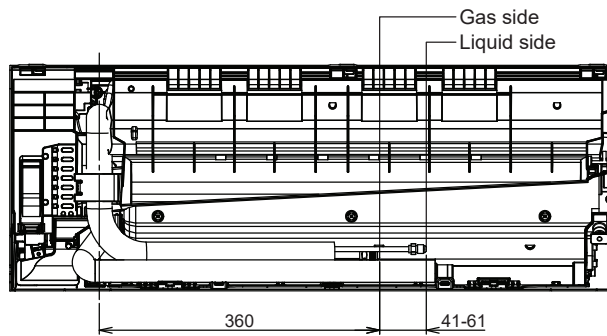

<Remote Control Holder>

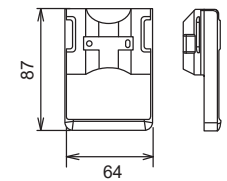

Relative position between the indoor unit and the installation plate <Front View>

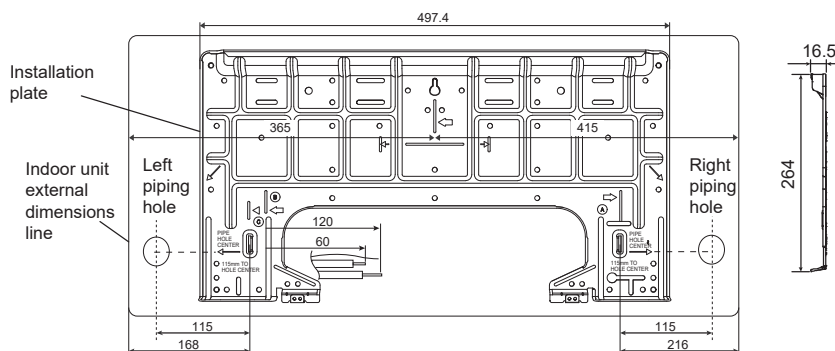

## 2 Outdoor Unit

