

# Panasonic®

Operating Instructions  
(Household) Hair Dryer  
Model No. EH-NA45

<b>English</b> .....	<b>3</b>
中文 .....	<b>13</b>
한글 .....	<b>21</b>
ไทย.....	<b>33</b>
Tiếng Việt .....	<b>43</b>
Bahasa Indonesia .....	<b>53</b>

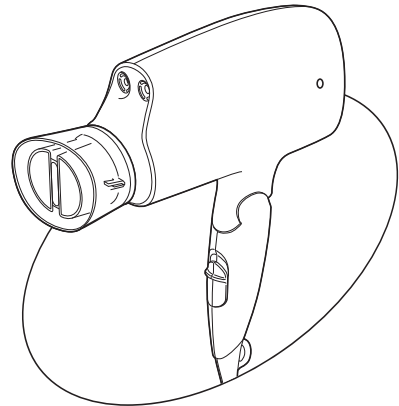

 **nanoe™**



## Operating Instructions (Household) Hair Dryer Model No. EH-NA45

### Contents

---

<b>Safety precautions.....</b>	<b>4</b>	<b>nanoe™ charge panel .....</b>	<b>9</b>
<b>Parts identification .....</b>	<b>7</b>	<b>Maintenance of the hair dryer .....</b>	<b>9</b>
<b>How to use the hair dryer .....</b>	<b>8</b>	<b>Troubleshooting .....</b>	<b>11</b>
<b>About nanoe™ .....</b>	<b>8</b>	<b>Specifications .....</b>	<b>11</b>
<b>About platinum ions.....</b>	<b>9</b>		

Thank you for purchasing this Panasonic product.

**Before operating this unit, please read these instructions completely and save them for future use.**

nanoe™ is a trademark of Panasonic Corporation.  
A nanoe™ is a nano-sized ion particle coated with water particles.

## Safety precautions

To reduce the risk of injury, loss of life, electric shock, fire, malfunction, and damage to equipment or property, always observe the following safety precautions.

### Explanation of symbols

The following symbols are used to classify and describe the level of hazard, injury, and property damage caused when the denotation is disregarded and improper use is performed.



## WARNING

Denotes a potential hazard that could result in serious injury or death.



## CAUTION

Denotes a hazard that could result in minor injury.

The following symbols are used to classify and describe the type of instructions to be observed.



This symbol is used to alert users to a specific operating procedure that must not be performed.



This symbol is used to alert users to a specific operating procedure that must be followed in order to operate the unit safely.



## WARNING



**Do not store within the reach of children or infants. Do not let them use it.**

- Doing so may cause burn, electric shock, or injury.



**Never modify, disassemble, or repair.**

- Doing so may cause ignition or injury due to abnormal operation.

Contact an authorized service center for repair.



**Do not damage or modify, or forcefully bend, pull, or twist the cord.**

**Also, do not place anything heavy on or pinch the cord.**

- Doing so may cause electric shock or fire due to a short circuit.



**Do not use with the cord bundled.**

- Doing so may cause fire or electric shock.





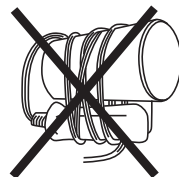



**Do not wrap the cord tightly around the main body when storing.**

- Doing so may cause the wire in the cord to break with the load, and may cause electric shock or fire due to a short circuit.





# WARNING

-  **Do not use when the power plug or cord is damaged or hot.**
  - Doing so may cause burn, electric shock, or fire due to a short circuit.
-  **Never use the appliance if the power plug fits loosely in a household outlet.**
  - Doing so may cause burn, electric shock, or fire due to a short circuit.
-  **Do not connect or disconnect the power plug to a household outlet with a wet hand.**
  - Doing so may cause electric shock or injury.
-  **Do not use the appliance with a wet hand.**
  - Doing so may cause electric shock or fire due to a short circuit.
-  **Do not leave the area with the main switch left on.**
  - Doing so may cause fire.
-  **Do not store the appliance in a bathroom or location with high humidity. Also, do not place in a location where water may spill (such as top of a vanity).**
  - Doing so may cause electric shock or fire.
-  **Do not block, or insert hair pins or other foreign objects into the air inlet, air outlet, nanoe™ outlet, or platinum ion outlet.**
  - Doing so may cause fire, electric shock, or burn.
-  **Do not use in proximity of flammable materials (such as alcohol, benzene, thinner, spray, hair care product, nail polish remover).**
  - Doing so may cause an explosion or fire.



- Do not immerse the appliance in water.**
- Do not use this hair dryer near water.**
- Do not use this hair dryer near bathtubs, showers, basins or other vessels containing water.**
  - Doing so may cause electric shock or fire.



This symbol on the hair dryer means “Do not use this hair dryer near water”.

**Immediately stop using and remove the power plug if there is an abnormality or failure.**

- Failure to do so may cause fire, electric shock, or injury.



**<Abnormality or failure cases>**

- **Air is not emitted**
- **Unit stops sporadically**
- **Interior becomes red hot and smoke is emitted**
  - Immediately request inspection or repair at an authorized service center.



**Use the household outlet alone: do not use with an extension cord.**

- Failure to do so may cause fire or electric shock.



**Fully insert the power plug.**

- Failure to do so may cause fire or electric shock.



**Always ensure the appliance is operated on an electric power source matched to the rated voltage indicated on the appliance.**

- Failure to do so may cause fire, electric shock, or burn.



## WARNING



When you see sparks around the air outlet while using the hot air setting, stop use and remove the lint on the air outlet and air inlet.

- Failure to do so may cause burn or fire.



Always turn OFF the main switch and disconnect the power plug from the household outlet after use.

- Failure to do so may cause fire or burn.



Disconnect the power plug by holding onto it instead of pulling on the cord.

- Failure to do so may cause the wire in the cord to break, and may cause burn, electric shock, or fire due to a short circuit.



Regularly clean the power plug to prevent dust from accumulating.

- Failure to do so may cause fire due to insulation failure caused by humidity.

Disconnect the power plug and wipe with a dry cloth.



When the hair dryer is used in a bathroom, unplug it after use since the proximity of water presents a hazard even when the hair dryer is switched off.

- Failure to do so may cause an accident or injury.



For additional protection, the installation of a residual current device (RCD) having a rated residual operating current not exceeding 30 mA is advisable in the electrical circuit supplying the bathroom. Ask your installer for advice.

- Failure to do so may cause an accident or injury.



This appliance is not intended for use by persons (including children) with reduced physical, sensory or mental capabilities, or lack of experience and knowledge, unless they have been given supervision or instruction concerning use of the appliance by a person responsible for their safety. Children should be supervised to ensure that they do not play with the appliance.

- Failure to do so may cause an accident or injury.



If the supply cord is damaged, it must be replaced by the manufacturer, its service agent, or similarly qualified persons in order to avoid a hazard.

- Failure to do so may cause an accident or injury.



## CAUTION

Do not store the cord in a twisted state.



- Doing so may cause the wire in the cord to break with the load, and may cause electric shock or fire due to a short circuit.



Do not drop or subject to shock.

- Doing so may cause electric shock or ignition.



Do not use with the air inlet damaged.

- Your hair may get dangled in the air inlet, which could damage the hair.



Do not touch the air outlet, quick-dry nozzle, and set nozzle, which will become very hot.

- Doing so may cause burn.



Do not use on children or infants.

- Doing so may cause burn.



# CAUTION

When unfolding or folding the handle, do not touch the shaded area as shown in figures below.

- Doing so may cause finger injury.

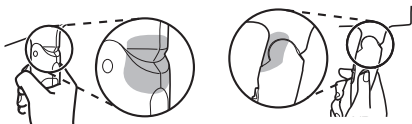

**Be careful about where you point the hair dryer, and be sure to keep your hair at least 10 cm away from the air inlet.**

- Your hair may get dangled in the air inlet, which could damage the hair.



**Please keep a distance of over 3 cm between the air outlet and your hair.**

- Failure to do so may result in your hair being burned.



**Only use for drying or styling human hair. (Do not use on pets, or to dry clothing, shoes, etc.)**

- Failure to do so may cause fire or burn.

## ► Notes

- This hair dryer is equipped with an automatic overheating protective device. If the hair dryer overheats, it will switch to cool air mode. Switch off the hair dryer and unplug it from the household outlet. Allow it to cool down for a few minutes before using it again. Check that no fluff, hair etc. is in the air inlets and air outlets before switching it on again.
- You may notice a characteristic odor when using this hair dryer. This is caused by the ozone it generates and is not harmful to the human body.

## Parts identification

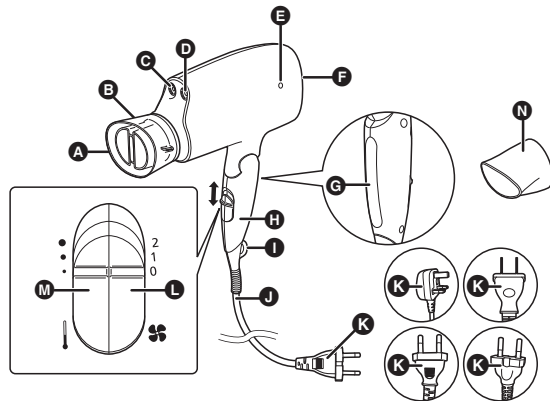

- A** Air outlet
- B** Quick-dry nozzle
- C** Platinum ion outlet
- D** nanoe™ outlet
- E** nanoe™ lamp
- F** Air inlet
- G** nanoe™ charge panel
- H** Handle
- I** Ring for hanging
- J** Cord
- K** Power plug  
(The shape of the power plug differs depending on the area.)
- L** Main switch (☸)  
2: Dry (Strong airflow)  
1: Set (Gentle airflow)  
0: Off
- M** Temperature selector (↕)  
● : Hot (Hot air)  
● : Healthy (Mild air)  
● : Cool (Cool air)
- N** Set nozzle

### ► Quick-dry nozzle

For drying hair quickly

Attach the quick-dry nozzle so this air outlet is vertical.

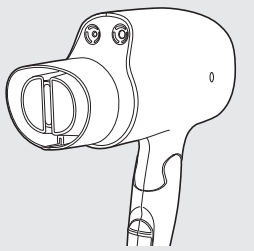

### ► Set nozzle

For precise styling

## How to use the hair dryer

- 1** Select the temperature of the airflow with the temperature selector (M).
- 2** Select the intensity of the airflow with the main switch (L).

### ► Notes

- If you use cool air to dry your hair, set the main switch (L) to position “1” or “2” and set the temperature selector to the “● : Cool (Cool air)” position.
- nanoe™ and platinum ions are produced when the main switch (L) is set to position “1” or “2”.
- nanoe™ and platinum ions are invisible to the naked eye.
- Use set nozzle (N) to concentrate the airflow.
- If you are worried about hair damage, set the switch to “1: Set (Gentle airflow)” before use.

- Drops of water may blow out of the nanoe™ outlet (D) during use, but this is not a malfunction.
- A humming noise may come out of the nanoe™ outlet (D), but this is the sound of nanoe™ being discharged and is not a malfunction.
- The effects of nanoe™ might not be felt by the following people. People with crimped hair, strong curly hair, very smooth hair, short hair, or who have had a hair straightening perm in the last three or four months.
- Do not use sprays near the dryer while it is in operation. The contents of the spray may be sucked into the dryer, resulting in deterioration of performance.

## About nanoe™

### What is nanoe™?

(nanoe™ generation method: High-voltage discharge)  
 nanoe™ is charged fine water particles, generated by applying high voltage in order to split water. Its diameter is smaller than 1/100 of steam, and it cannot be seen with the naked eye. Since nanoe™ is generated by collecting water in the air, it may be difficult to generate in certain cases depending on the environment.

(It is harder to collect water in the air when it is cold and humidity is low.)

### How nanoe™ works

Generally hair has properties which make it easy to become positively charged with electricity. These properties attract strongly negatively charged nanoe™ which penetrates the hair with moisture. Furthermore, they make the hair slightly acidic, tighten cuticles and keep your hair strong, elastic and healthy.

## About platinum ions

### What are platinum ions?

Platinum Ion Generation method: High-voltage discharge

Ions are particles that combine negatively charged oxygen and moisture in the air. Platinum ions are the ions generated from the platinum electrode. These ions are invisible to the naked eye because their diameter is just 1/1000th that of a particle of steam.

### How platinum ions work

In general, hair is easily positively charged. By exposing hair to the negatively charged platinum ions, the hair's static electricity can be neutralized and thus its smoothness can be enhanced.

The platinum ions not only penetrate each and every strand of hair, but also coat the hair, and thus help it maintain the moisture content and alleviate the UV damage.

#### ► Note

The effect of ion does not show up too much on person with features described below.

- Having original curl hair.
- Having hair to be furled easily.
- Having wonderful and tidy hair.
- Having hair straightening perm no more than 3 – 4 months.
- Having short hair.

## nanoe™ charge panel

When nanoe™/platinum ions continue to strike hair, hair becomes negatively charged. As a result, the nanoe™/platinum ions and negatively charged hair repel each other, making it difficult for nanoe™/platinum ions to reach hair. With the nanoe™ Charge System, by just gripping the panel together with the handle, the negative charge accumulated on hair is released.

Because of this, nanoe™/platinum ions continue to penetrate into hair, supplying moisture and thoroughly moistening down to the tips of hair.

### Maintenance of the hair dryer

- Make sure to turn OFF the main switch and disconnect the power plug from the household outlet. (Except when performing maintenance on the air outlet)

### Maintaining the hair dryer

Clean the housing only with a soft cloth slightly dampened with tap water or soapy tap water.

#### ► Notes

- Do not use thinner, benzene, alcohol or other chemicals.
  - Doing so may cause malfunction, cracking/discoloration of parts etc.
- Leaving the hair dryer with hair products or makeup still adhered to the handle or body may degrade the plastic, causing discoloration or cracking, and malfunction.

## Maintaining the nanoe™ outlet

- Use commercially available cotton swabs. (We recommend the thin cotton swabs made for use with babies.)
- This maintenance allows the hair dryer to sustain the generated level of nanoe™ over a long period.

1. Dampen the end of the cotton swab with tap water.
2. A needle portion is located deep within the nanoe™ outlet. Using the swab, rub this portion gently about 5 times.

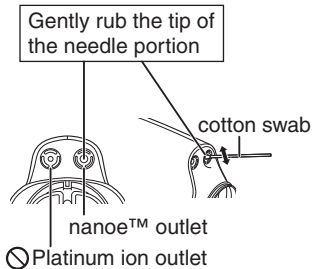

Do not attempt to clean the platinum ion outlet (⊙). (The outlet has a structure which makes it difficult to insert the swab.)  
Doing so results in losing its ability to release platinum ions.

## Maintaining the air inlet

- Wipe to clean lint, hair, or other matter from the air inlet with a tissue.
- Do not press or rub the air inlet with a nail or other sharp object. Doing so may damage the air inlet.

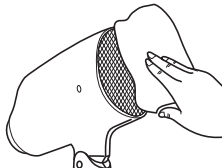

## Maintaining the air outlet

- The hair dryer should be plugged into the household outlet only in case of maintenance for the air outlet.
- Use a commercially available toothbrush.
- Switch the temperature selector to “Cool” and blow away the dust etc. as you scrub with the toothbrush.
- During maintenance, do not block the air inlet with your hands etc.
- Be careful when using the hair dryer for the first time after maintenance, since it may blow out dust etc.

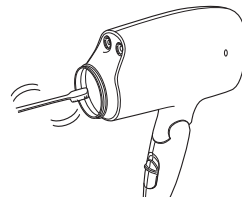

Scrub to remove any dust, hair etc. blocking the mesh.

## Troubleshooting

Problem	Possible cause	Action
It switches frequently to cold air while using in "Hot" mode, or sparks can be seen within the body. (These sparks are caused by the thermostat switch, the protective device, and this is not a malfunction.)	▶ Lint has accumulated on the air inlet or air outlet.	▶ Remove accumulated lint.
The hot air is abnormally hot.	▶ Hair or something is blocking the air inlet.	▶ Do not block the air inlet.
The power plug is abnormally hot.	▶ The connection to the household outlet is loose.	▶ Use a household outlet that fits securely.
Sparks are generated inside the nanoe™ outlet.	▶ Abnormality caused by a dirty electrode (needle portion).	▶ Perform maintenance of the nanoe™ outlet.
The nanoe™ outlet emits a noise (crackling noise).		

If the problems still cannot be solved, contact the store where you purchased the unit or a service center authorised by Panasonic for repair.

## Specifications

Product name	Hair Dryer		
Product model	EH-NA45		
Power source	220 V ~ 50-60 Hz	230 V ~ 50-60 Hz	240 V ~ 50-60 Hz
Power consumption	1350 W	1500 W	1600 W
Accessories	Quick-dry nozzle, set nozzle		

This product is intended for household use only.



## 目錄

安全須知.....	14	nanoe™ 板 .....	18
部件說明.....	17	保養吹風機 .....	19
使用吹風機的方法.....	17	疑難排解.....	20
有關 nanoe™ .....	18	規格 .....	20
關於白金離子 .....	18		

感謝您購買本 Panasonic 產品。

使用本產品之前，請仔細閱讀本說明書，並妥善保存以供未來使用。

nanoe™ 為 Panasonic Corporation 的商標。  
nanoe™ 是以水分子包裹的奈米離子。

## 安全須知

為減低受傷、死亡、觸電、火警、故障、產品損壞及財物損失的風險，請務必留意以下安全須知。

## 符號說明

以下符號用於為危險、傷害及財物損失的級別分類和作出解釋。若不理會此等符號，不當使用本產品就可能導致所述的危險、人身傷害及財物損失。

 **警告** 表示潛在的危險可能會導致嚴重受傷或致命。

 **注意** 表示危險可導致輕微受傷。

以下符號用於分類和解釋必須留意的指示類型。

 此符號用於提示用戶，不得執行某項特定的操作程序。

 此符號用於提示用戶，必須遵從某項特定的操作程序，藉以安全操作本產品。

## 警告

 切勿將產品存放於兒童或幼童可觸摸的地方。請勿讓兒童或幼童使用。  
- 否則可能會造成灼傷、觸電或受傷。

 切勿改裝、拆卸或修理。  
- 否則可能會導致點火，或因異常操作而造成傷害。請聯絡 Panasonic 直屬服務站進行維修。

 切勿損壞、改裝、用力彎曲、拉扯或纏繞電源線。此外，切勿將重物放在電源線上或夾緊電源線。  
- 否則可能會因短路而導致觸電或火警。

 切勿在電源線網綁時使用。  
- 否則可能造成火警或觸電。

儲藏時，切勿將電源線緊緊纏繞住本機。  
- 否則可令電源線內的電線因負荷而斷裂，並導致觸電或因短路而導致火警。

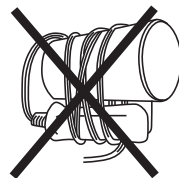

 當電源插頭或電源線已經損壞或發熱時，切勿使用。  
- 否則可能會造成灼傷、觸電或因短路而導致火警。

 如果電源插頭在家用電源插座內有鬆動現象，切勿使用本產品。  
- 否則可能會造成灼傷、觸電或因短路而導致火警。

## 警告

 切勿在手濕時將電源插頭插入家用電源插座或從插座中拔除。  
- 否則可導致觸電或受傷。

 切勿在手濕時使用本產品。  
- 否則可能會因短路而導致觸電或火警。

 當電源開關開啓時，切勿離開該區域。  
- 否則可能造成火警。

 切勿將本產品放置在浴室或濕度很高的地方。另外，請不要放置在可能會潑濺到水的地方（例如，梳妝台頂部）。  
- 否則可能造成觸電或火警。

 切勿堵塞或插入髮夾或其他異物到入風口、出風口、nanoe™ 出風口或白金離子出風口。  
- 否則可能造成火警、觸電或灼傷。

 切勿在有易燃物質（例如，酒精、揮發油、稀釋劑、噴霧、護髮產品、去光水）附近使用。  
- 否則可能造成爆炸或火警。

 切勿將本產品浸入水中。  
切勿在靠水的地方使用本吹風機。  
切勿在靠近浴缸、蓮蓬頭、水盆或其他裝水的容器附近使用本吹風機。  
- 否則可能造成觸電或火警。



位於吹風機上的這個符號表示「切勿在近水處使用本吹風機」。

如果出現異常或故障，請立即停止使用並拔除電源插頭。  
- 否則可能會造成火警、觸電或受傷。

< 異常或故障情況 >

 • 無法送風  
• 本機偶爾停止  
• 內部變成火紅炙熱狀且冒煙  
- 請立即將產品帶往 Panasonic 直屬服務站，以要求檢查或維修。

 請使用獨立的家用電源插座：切勿搭配延長電源線使用。  
- 否則可能造成火警或觸電。

 請完全插入電源插頭。  
- 否則可能造成火警或觸電。

 請務必確保在符合本產品上指定的額定電壓的電源上操作本產品。  
- 否則可導致火警、觸電或灼傷。

 使用熱風設定時，如果您看到出風口處出現火花，請停止使用並清除出風口與入風口處的棉絮。  
- 否則可能造成灼傷或火警。

 使用後，請務必關閉電源開關並從家用插座拔除電源插頭。  
- 否則可能造成火警或灼傷。

 拔除電源插頭時，請握住插頭，不要拉扯電源線。  
- 否則可能造成電源線中的電線斷裂，並導致灼傷、觸電或因短路而導致火警。

 請定期清潔電源插頭，避免灰塵堆積。  
- 否則濕氣可令絕緣失效，導致火警。  
請拔除電源插頭並使用乾布擦拭。

 若在浴室中使用吹風機，使用完畢後請拔下電源插頭，因為即使吹風機已經關掉，它在接近水時仍然存在危險。  
- 否則可能導致意外或受傷。

## 警告

為了保護您的安全，建議您在浴室的供電電路中安裝一個額定漏電動作電流不超過 30 mA 的漏電保護開關 (RCD)。請向安裝者諮詢意見。  
- 否則可能導致意外或受傷。

患有體能、感官或智力減退，或缺乏經歷和知識之人士 (含小孩)，在無人監護或未獲告知如何使用的情况下不得使用本產品。  
請勿讓小孩使用本產品。  
- 否則可能導致意外或受傷。

如果本機的電源線已經損壞，務必立即停止使用，並送交 Panasonic 直屬服務站進行更換。  
- 否則可能導致意外或受傷。

## 注意

切勿以纏繞的方式收藏電源線。  
- 否則可令電源線內的電線因負荷而斷裂，並導致觸電或因短路而導致火警。

切勿掉下產品或使其受到撞擊。  
- 否則可能造成觸電或點火。

當入風口損壞時，切勿使用。  
- 您的頭髮可能會在入風口處飄盪，這會讓頭髮受損。

切勿接觸出風口、速乾護髮吹嘴及定型吹嘴，這些部位溫度非常高。  
- 否則可能造成灼傷。

切勿對幼童或嬰兒使用。  
- 否則可能造成灼傷。

拉長或縮回把手時，切勿接觸下圖所示的陰影區域。  
- 否則可能造成手指受傷。

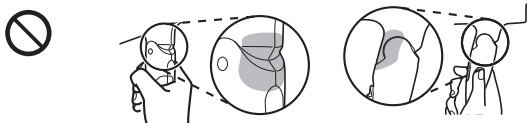

小心注意自己手持吹風機的方向，並確保您的頭髮與入風口保持最少 10 cm 的距離。  
- 您的頭髮可能會在入風口處飄盪，這會讓頭髮受損。

請將您的頭髮與出風口之間保持超過 3 cm 的距離。  
- 否則可能造成您的頭髮被燒焦。

請僅用於吹乾或造型人類頭髮。(切勿用於寵物或吹乾衣物、烘鞋等用途)。  
- 否則可能造成火警或灼傷。

### 註

- 本吹風機配備一個自動過熱保護裝置。如果吹風機過熱，將轉換到冷風模式。請關閉吹風機，並從家用插座中拔除。等讓吹風機冷卻數分鐘後再使用。再次開啓吹風機前，請檢查入風口與出風口內無毛絮、頭髮等。
- 使用吹風機時可能會聞到一種特別的氣味。這是由吹風機產生的臭氧引起的，對人體無害。

### 緊急處理方法：

使用中，本產品若有冒煙或火花情形時，請立即關閉電源及拔掉插頭。並立即通知 Panasonic 直屬服務站處理，以便查明原因。

## 部件說明

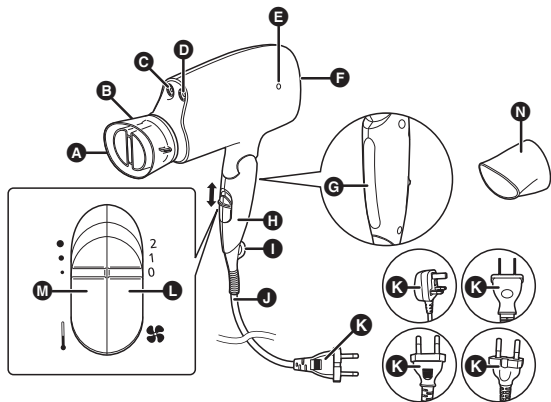

- A** 出風口  
**B** 速乾護髮吹嘴  
**C** 白金離子出風口  
**D** nanoe™ 出風口  
**E** nanoe™ 指示燈  
**F** 入風口  
**G** nanoe™ 板  
**H** 把手  
**I** 掛環  
**J** 電源線  
**K** 電源插頭  
(電源插頭的形狀視地區而異。)
- L** 電源開關 ( )  
2: 強風  
1: 柔風  
0: 關
- M** 溫度選擇開關 ( | )  
● : 熱風  
● : 暖風  
● : 冷風
- N** 造型吹嘴

### ►速乾護髮吹嘴 用於快速乾燥頭髮

請連接速乾護髮吹嘴，使該出風口成垂直。

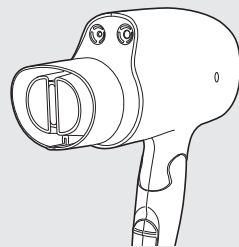

### ►造型吹嘴 精準造型

## 使用吹風機的方法

- 1 使用溫度選擇開關 (M) 選擇風溫。
- 2 使用電源開關 (L) 選擇風力強度。

### ►註

- 如果您用冷風吹乾頭髮，請將電源開關 (L) 設定到「1」或「2」的位置，並將溫度選擇開關設定為「● : 冷風」位置。
- nanoe™ 與白金離子會在當電源開關 (L) 設定到「1」或「2」位置時產生。
- nanoe™ 與白金離子對於肉眼而言並不可見。
- 請使用造型吹嘴 (N) 以集中氣流。
- 若您擔心髮質受損，使用前請將開關調到「1: 柔風」。
- 吹風機使用期間，水滴可能會從 nanoe™ 出風口 (D) 吹出，但這種情況並非故障。

- nanoe™ 出風口 (D) 可能會發出嗡嗡聲響，不過這是放出 nanoe™ 時的聲音，而並非產品出現故障。
- 以下髮型的人可能感覺不到 nanoe™ 的效果：有波浪形的頭髮、牢固的捲髮、特別不順的頭髮、短髮，或三四個月前曾燙直過頭髮的人。
- 使用吹風機時請勿在近距離處同時使用頭髮噴霧劑。頭髮噴霧劑的成分被吸入吹風機，可能會影響吹風機的性能。

## 有關 nanoe™

### 甚麼是 nanoe™ ？

(產生 nanoe™ 的方法：高壓放電)  
 nanoe™ 是帶電的細微水分子，以高壓電將水分子分解後產生。其直徑比水氣的 1/100 還要小，因此無法以肉眼看見。由於 nanoe™ 的產生源自於空氣中的水分，因此，其能否形成取決於使用時所處的環境而定。  
 (在寒冷或濕度低的情況下，較難從空氣中收集水分。)

### nanoe™ 如何產生作用

一般情況下，頭髮本身具有某些特性，使之容易帶上正電。這使頭髮可以強烈吸附那些隨水分進入頭髮、帶靜電的 nanoe™，進一步使頭髮呈弱酸性，緊緻頭皮，使頭髮強韌、有彈性，保持健康。

## 關於白金離子

### 什麼是白金離子？

白金離子產生方法：高壓放電

離子是帶負電荷的氧氣與空氣中的濕氣結合所產生的分子。白金離子是從白金電極所產生的離子。由於其直徑只有水氣的 1/1000，因此無法以肉眼看見。

### 白金離子的運作方式

一般而言，頭髮很容易帶正電。將頭髮暴露在帶負電的白金離子後，頭髮的靜電將被中性化，藉此強化其柔順度。白金離子不僅能滲透到每根頭髮的髮梢，還能遮覆頭髮，協助保濕與舒緩紫外線的傷害。

#### ► 註

離子的效果對於以下所述髮質的人士而言可能不明顯。

- 原本即為捲髮者。
- 容易捲髮者。
- 擁有特別平順與整齊的頭髮者。
- 三四個月內燙直過頭髮者。
- 短髮者。

## nanoe™ 板

使用 nanoe™/ 白金離子持續吹髮時，頭髮將帶負電荷。其結果將造成 nanoe™/ 白金離子與帶負電荷的頭髮互斥，這將讓 nanoe™/ 白金離子難以進入頭髮。

有了 nanoe™ 板 (把手部位)，只須緊握把手，頭髮上所積累的負電荷就會被釋放。

因此，nanoe™/ 白金離子會持續滲透到頭髮內部，為頭髮補充水分，使頭髮得以徹底滋潤，而且直達髮尖。

## 保養吹風機

- 請務必關閉電源開關並從家用插座拔除電源插頭。(對出風口進行保養時除外)

## 吹風機的保養

請以自來水或肥皂水稍微浸濕的軟布來清潔外殼。

### ▶註

- 切勿使用稀釋劑、揮發油、酒精或其他化學品。
  - 否則可能導致產品故障、部件破裂或褪色等。
- 不去除黏附在吹風機手把或機身上的髮型用品或化妝品，可能令塑料分解，導致產品褪色或破裂及導致產品故障。

## nanoe™ 出風口的保養

- 使用市面上有售的棉花棒。(建議使用嬰兒適用的薄棉花棒。)
- 這項保養可使吹風機長期保持產生 nanoe™ 的水平。

- 用清水沾濕棉花棒的前端。
- 針頭部分在 nanoe™ 出風口的內部深處。以棉花棒在此處輕拭約 5 次。

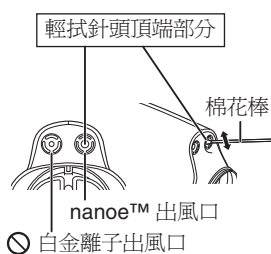

切勿嘗試清潔白金離子出風口 (C)。(出風口的結構棉籤難以插入。)  
否則可能造成白金離子無法釋放。

## 入風口的保養

請使用衛生紙將入風口的棉絮、頭髮或其他東西擦拭乾淨。

- 切勿使用指甲或其他尖銳物體按壓或摩擦入風口。否則可能會損壞入風口。

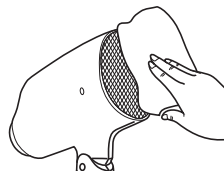

## 出風口的保養

- 若僅保養出風口時，才應該將吹風機插入到家用電源插座。
- 使用市售的牙刷。
- 將溫度選擇開關調到「冷風」，然後再使用牙刷刷出灰塵時將其吹走。
- 保養期間，切勿以手或其他物件阻擋入風口。
- 保養吹風機後首次使用時應多加小心，因為吹風機可能會吹出塵埃等物體。

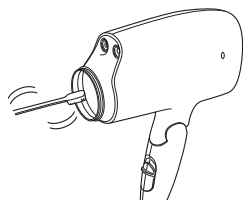

刷去塵埃、頭髮等阻擋網孔的物體。

## 疑難排解

中文

問題	導致故障原因	措施
使用「熱風」模式時，如果頻繁地切換到冷風，可能會在本機內部看見火花。 (這些火花是因恆溫開關、保護裝置造成，此並非為故障。)	棉絮堆積在入風口或出風口。	清除堆積的棉絮。
熱風異常高溫。	在入風口有堵塞頭髮或其他東西。	切勿堵塞入風口。
電源插頭異常高溫。	與家用插座的連接鬆動。	請使用能穩固固定的家用插座。
在 nanoe™ 出風口內部產生火花。	由於電極髒污所造成的異常（針尖部位）。	請進行 nanoe™ 出風口保養。
nanoe™ 出風口有異音（爆裂聲）。		

如果仍然無法解決問題，請與您購買本機的商店聯繫，或洽 Panasonic 直屬服務站進行維修。

## 規格

[ 僅限台灣 ]

產品名稱	吹風機			
產品機型	EH-NA45			
電源	220 V ~ 50-60 Hz	230 V ~ 50-60 Hz	240 V ~ 50-60 Hz	110 V ~ 60 Hz (僅適用於台灣。)
消耗電量	1350 W	1500 W	1600 W	1400 W
配件	速乾護髮吹嘴、造型吹嘴			

此產品只適於家居內使用。

製造商：Panasonic Corporation

生產國別：泰國

進口商：台松電器販賣股份有限公司（僅限台灣）

公司地址：新北市中和區建六路 57 號

連絡地址：新北市中和區員山路 579 號

連絡電話：(02)2223-5121

網址：<http://panasonic.com.tw>

## 목차

안전 주의 사항.....	22	nanoe™ 충전 패널.....	28
부품 명칭.....	26	모발건조기 관리.....	28
헤어 드라이어 사용법.....	26	문제 해결.....	30
nanoe™ 소개.....	27	사양.....	31
백금 이온 정보.....	27		

본 Panasonic 제품을 구입해 주셔서 감사합니다.  
이 기기를 사용하기 전에, 이 사용 설명서를 잘 읽고 다음을 위해 보관하십시오.

nanoe™는 Panasonic Corporation의 상표입니다.  
nanoe™은 물 입자로 코팅된 나노 크기의 이온 입자입니다.

## 안전 주의 사항

부상, 사망, 감전, 화재, 고장, 장비 손상 또는 재산상의 피해 위험을 줄이려면 항상 다음의 안전 주의 사항을 준수하십시오.

### 기호 설명

다음의 기호는 지시를 무시하고 부적절하게 사용할 경우 발생하는 위험, 부상 및 재산 피해 수준을 분류하고 설명하는 데 사용됩니다.

 **경고** 심각한 부상이나 사망을 초래할 수 있는 잠재적인 위험을 나타냅니다.

 **주의** 경미한 부상을 초래할 수 있는 위험을 나타냅니다.

다음의 기호는 준수할 지침 유형을 분류하고 설명하는 데 사용됩니다.

 이 기호는 수행해서는 안 되는 특정 작동 절차를 사용자에게 알리는 데 사용됩니다.

 이 기호는 기기를 안전하게 작동하기 위해서 반드시 준수해야 하는 특정 작동 절차를 사용자에게 알리는 데 사용됩니다.

## 경고

 어린이나 유아의 손이 닿을 수 있는 곳에 보관하지 마십시오. 어린이나 유아가 기기를 사용하지 못하게 하십시오.

-이렇게 하면 화상, 감전 또는 부상을 초래할 수 있습니다.

 절대 개조, 분해 또는 수리하지 마십시오.

-이렇게 하면 정화가 발생하거나 비정상적인 작동으로 인한 부상을 입을 수 있습니다.  
수리는 공인 서비스 센터에 문의하십시오.

 코드를 손상시키고 개조하거나 억지로 구부리고 당기거나 비틀지 마십시오.

 또한 코드 위에 무거운 물체를 올려두거나 꼭 조이지 마십시오.

-이렇게 하면 감전 또는 단락으로 인한 화재를 초래할 수 있습니다.

 코드를 다발로 묶은 상태로 사용하지 마십시오.







-이렇게 하면 화재 또는 감전을 초래할 수 있습니다.



 보관 시 본체 주변에 코드를 세게 감아두지 마십시오.

-이렇게 하면 코드 내의 전선에 힘이 가해져 끊어지고 감전 또는 단락으로 인한 화재가 발생할 수 있습니다.





## ⚠ 경고

-  전원 플러그 또는 코드가 손상되거나 뜨거운 경우에는 사용하지 마십시오.  
-이렇게 하면 화재, 감전 또는 단락으로 인한 화재를 초래할 수 있습니다.
-  전원 플러그가 가정용 콘센트에 헐거워진 경우 절대 기기를 사용하지 마십시오.  
-이렇게 하면 화재, 감전 또는 단락으로 인한 화재를 초래할 수 있습니다.
-  젖은 손으로 전원 플러그를 가정용 콘센트에 연결하거나 분리하지 마십시오.  
-이렇게 하면 감전이나 부상을 초래할 수 있습니다.
-  젖은 손으로 기기를 사용하지 마십시오.  
-이렇게 하면 감전 또는 단락으로 인한 화재를 초래할 수 있습니다.
-  스위치를 켜둔 상태로 자리를 비우지 마십시오.  
-이렇게 하면 화재를 초래할 수 있습니다.
-  기기를 욕실이나 습도가 높은 장소에 보관하지 마십시오. 또한 물이 쏟아질 수 있는 곳 (예: 세면대 위)에 놓지 마십시오.  
-이렇게 하면 감전 또는 화재를 초래할 수 있습니다.
-  공기 입구, 공기 배출구, nanoe™ 배출구 또는 백금 이온 배출구를 막거나 머리카락 또는 기타 외부 물체를 집어 넣지 마십시오.  
-이렇게 하면 화재, 감전 또는 화상을 초래할 수 있습니다.

-  자연성 물질 (예: 알코올, 벤젠, 시너, 스프레이, 헤어 관리 제품, 매니큐어 리무버 등) 근처에서 사용하지 마십시오.  
-이렇게 하면 폭발 또는 화재를 초래할 수 있습니다.
-  기기를 물에 담그지 마십시오.  
이 모발건조기를 물 근처에서 사용하지 마십시오.  
욕조, 샤워 시설, 세면기 또는 물을 담고 있는 기타 용기 가까이에서 이 헤어 드라이어를 사용하지 마십시오.  
-이렇게 하면 감전 또는 화재를 초래할 수 있습니다.



헤어 드라이어에 있는 이 기호는 “물 가까이에서 이 헤어 드라이어를 사용하지 말라”는 지침을 의미합니다.

- 이상이나 장애가 발생한 경우에는 즉시 사용을 중단하고 전원 플러그를 분리하십시오.  
-이렇게 하지 않으면 화재, 감전 또는 부상을 입을 수 있습니다.
-  < 이상 또는 장애가 발생한 경우 >
  - 공기가 방출되지 않음
  - 기기가 우발적으로 멈춤
  - 내부가 빨갛게 가열되고 연기가 나옴-공인 서비스 센터에 즉시 검사나 수리를 요청하십시오.
- 가정용 콘센트만 사용하십시오. 연장 코드와 함께 사용하지 마십시오.  
 -이렇게 하지 않으면 화재 또는 감전을 초래할 수 있습니다.

## 경고

전원 플러그를 완전히 삽입하십시오 .

-  -이렇게 하지 않으면 화재 또는 감전을 초래할 수 있습니다 .

항상 기기에 명시된 정격 전압과 일치하는 전기 전원을 사용하여 기기를 작동하도록 하십시오 .

-  -이렇게 하지 않으면 화재 , 감전 또는 화상을 입을 수 있습니다 .

뜨거운 공기 설정을 사용하는 중에 공기 배출구 주변에 스파크가 발생하면 사용을 멈추고 공기 배출구와 공기 입구에서 보풀을 제거하십시오 .

-  -이렇게 하지 않으면 화상 또는 화재를 초래할 수 있습니다 .

사용 후에는 항상 스위치를 끄고 가정용 콘센트에서 전원 플러그를 분리해 두십시오 .

-  -이렇게 하지 않으면 화재 또는 화상을 초래할 수 있습니다 .

코드를 잡아 당기지 말고 코드를 잡은 상태에서 전원 플러그를 분리하십시오 .

-  -이렇게 하지 않으면 코드 내의 전선이 끊어지고 화상 , 감전 또는 단락으로 인한 화재가 발생할 수 있습니다 .

전원 플러그를 정기적으로 청소하여 먼지가 축적되지 않게 하십시오 .

-  -이렇게 하지 않으면 습도로 인해 절연 장애가 발생하여 화재를 초래할 수 있습니다 .  
전원 플러그를 분리하고 마른 천으로 닦아 내십시오 .

욕실에서 헤어 드라이어를 사용하는 경우 사용 후에 전원 플러그를 뽑아 주십시오 . 헤어 드라이어를 켜둘 때에도 물기가 남아서 위험을 유발할 수 있습니다 .

-  -이렇게 하지 않으면 사고나 부상을 초래할 수 있습니다 .

욕실의 전기 회로에는 정격 잔류 가동 전류가 30 mA 를 초과하지 않는 잔류 전류 차단 장치 (RCD) 를 설치하는 것이 좋습니다 . 궁극한 점이 있으면 해당 전기 설치 기술자에게 문의하십시오 .

-  -이렇게 하지 않으면 사고나 부상을 초래할 수 있습니다 .

안전 책임자가 기기의 사용 지침 또는 지도를 해준 경우가 아니라면 (어린이를 포함하여) 신체 , 감각 , 정신 장애가 있거나 경험과 지식이 부족한 사람들은 이 기기를 사용할 수 없습니다 .

-  이 기기를 어린이가 가지고 놀지 않도록 지도해야 합니다 .

-이렇게 하지 않으면 사고나 부상을 초래할 수 있습니다 .

공급코드가 파손된 경우에는 위험을 방지하기 위해 , 제조업자나 서비스 에이전트 또는 동등한 자격을 갖고 있는 담당자가 교체해야 한다 .

-  -이렇게 하지 않으면 사고나 부상을 초래할 수 있습니다 .

## 주의

코드를 꼬아 놓은 상태로 보관하지 마십시오 .

-  -이렇게 하면 코드 내의 전선에 힘이 가해져 끊어지고 감전 또는 단락으로 인한 화재가 발생할 수 있습니다 .

## ⚠ 주의

❌ 제품을 떨어뜨리거나 충격을 가하지 마십시오.  
- 이렇게 하면 감전 또는 점화를 초래할 수 있습니다.

❌ 공기 입구가 손상된 상태로 사용하지 마십시오.  
- 머리카락이 공기 입구에 걸려 모발이 손상될 수 있습니다.

❌ 공기 배출구, 고속 건조 노즐 및 세팅 노즐은 매우 뜨거워지므로 만지지 마십시오.  
- 이렇게 하면 화상을 입을 수 있습니다.

❌ 어린이 또는 유아에게는 사용하지 마십시오.  
- 이렇게 하면 화상을 입을 수 있습니다.

손잡이를 펼치거나 접을 때는 아래 그림과 같이 음영 부분을 만지지 마십시오.

- 이렇게 하면 손가락에 부상을 입을 수 있습니다.

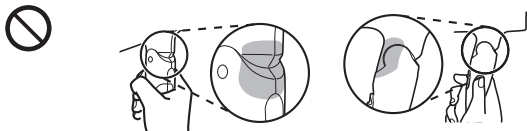

헤어 드라이어를 갖다 대는 위치에 주의하고, 머리카락이 공기 입구에서 최소 10 cm 이상 떨어진 지점에서 사용하십시오.

- 머리카락이 공기 입구에 걸려 모발이 손상될 수 있습니다.

❌ 공기 배출구와 머리카락 사이의 거리를 3 cm 이상으로 유지하십시오.

- 이렇게 하지 않으면 머리카락이 탈 수 있습니다.

사람의 머리카락을 말리거나 스타일링하는 용도로만 사용하십시오. (애완동물에게 사용하거나 옷, 신발 등을 말리는 데 사용하지 마십시오.)

❗ - 이렇게 하지 않으면 화재 또는 화상을 초래할 수 있습니다.

### ▶ 메모

- 이 모발건조기에는 자동 과열 방지 장치가 들어 있습니다. 따라서 모발건조기가 과열되면 찬 공기 모드로 바뀝니다. 이때 모발건조기를 끄고 전원 소켓에서 플러그를 뽑아주십시오. 몇 분 정도 시간을 두어 드라이어가 충분히 식은 후에 다시 사용하십시오. 다시 전원을 연결하기 앞서 공기 입구와 공기 배출구에 유입된 보풀이나 머리카락 등이 없는지 확인하십시오.
- 이 헤어 드라이어를 사용할 때 독특한 냄새를 느낄 수 있을 것입니다. 이것은 헤어 드라이어가 생성해내는 오존 때문이며 인체에는 전혀 해가 없습니다.

## 부품 명칭

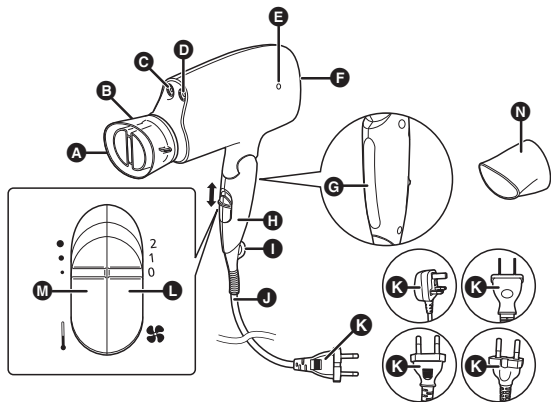

- A** 공기 배출구
- B** 고속 건조 노즐
- C** 백금 이온 배출구
- D** nanoe™ 배출구
- E** nanoe™ 램프
- F** 공기 입구
- G** nanoe™ 충전 패널
- H** 손잡이
- I** 고리
- J** 코드
- K** 전원 플러그  
(전원 플러그의 모양은 지역에 따라 다릅니다.)
- L** 스위치 ( )  
2: Dry (강한 바람)  
1: Set (부드러운 바람)  
0: Off (꺼짐)
- M** 풍온 장치 ( )  
● : Hot (뜨거운 공기)  
● : Healthy (부드러운 공기)  
● : Cool (찬 공기)
- N** 세팅 노즐

### ▶ 고속 건조 노즐

모발을 빠르게 말릴 때 사용

공기 배출구가 수직이 되도록 고속 건조 노즐을 부착합니다.

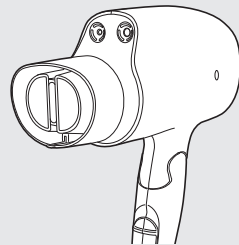

### ▶ 세팅 노즐

정교한 스타일링에 사용

## 헤어 드라이어 사용법

**1** 풍온 장치 (M) 로 바람의 온도를 선택합니다.

**2** 스위치 (L) 로 바람의 세기를 선택합니다.

### ▶ 메모

- 찬 공기를 사용하여 머리를 말릴 경우, 스위치 (L) 를 “1” 또는 “2” 위치로 설정하고 풍온 장치를 “● : Cool (찬 공기)” 위치로 설정하십시오.
- 스위치 (L) 가 “1” 또는 “2” 위치로 설정되면 nanoe™ 및 백금 이온이 생성됩니다.
- nanoe™ 및 백금 이온은 육안으로 보이지 않습니다.
- 공기 흐름을 한 곳으로 모으려면 세팅 노즐 (N) 을 사용하십시오.

- 머리카락 손상이 염려되는 경우, 사용 전에 스위치를 “1: Set ( 부드러운 바람 )” 으로 설정하십시오 .
- 사용 중 **nanoe™** 배출구 (D) 에서 물방울이 떨어질 수 있으며, 이는 고장이 아닙니다 .
- **nanoe™** 배출구 (D) 에서 웅웅거리는 소음이 날 수 있으나, 이는 **nanoe™** 이 배출될 때 나는 소리이며 고장이 아닙니다 .
- 다음과 같은 사람들은 **nanoe™** 의 효과를 느끼지 못할 수도 있습니다 . 굵슬머리, 역센 굵슬머리, 매우 가늘고 힘이 없는 머리, 짧은 머리카락, 최근 3 - 4 개월 이내에 스트레이트 파마로 편 직모 .
- 작동중인 드라이어 근처에서 스프레이를 사용하지 마십시오 . 스프레이의 성분이 드라이어에 빨려들어가 성능이 저하되는 경우가 있습니다 .

## nanoe™ 소개

### nanoe™ 란 ?

(nanoe™ 생성 방법 : 고압 방전 )

**nanoe™** 는 물에 고전압을 적용할 때 물을 서로 분리하면서 생성되는 미세 물 입자로 방전됩니다 . 입자의 직경은 증기의 1/100 보다 작은 크기로, 육안으로는 볼 수 없습니다 . 사용 환경에 따라 생성되는 방법이 아닌 공기 중의 물 ( 습기 ) 이 모여서 **nanoe™** 를 만듭니다 .

( 저온과 습도가 낮을 때에는 공기 중의 물 ( 습기 ) 을 모으기가 더 어렵니다 . )

### nanoe™ 의 작용 원리

일반적으로 머릿결에는 전기가 적용될 때 양성이 되려는 성질이 있습니다 . 이러한 특성이 머릿결에 보습 효과를 주는 음성 **nanoe™** 을 강하게 끌어당깁니다 . 또한 머릿결에 약간의 산성과 조밀한 외피를 만들어 주어 머릿결을 강하게 , 그리고 탄력과 건강함을 유지해줍니다 .

## 백금 이온 정보

### 백금 이온이란 ?

백금 이온 생성 방법 : 고압 방전

이온은 음전하를 가진 산소와 공기 중의 수분이 결합하여 만들어지는 입자입니다 . 백금 이온은 백금 전하로부터 생성되는 이온입니다 . 이러한 이온은 직경이 증기의 1/1000 보다 작은 크기이기 때문에 육안으로 볼 수 없습니다 .

### 백금 이온의 작용 방식

일반적으로 모발은 쉽게 양전하를 띠게 됩니다 . 모발이 음전하 백금 이온에 노출되면 머리카락의 정전기가 중화되어 모발이 한층 더 부드러워집니다 . 백금 이온은 각각의 모발 가닥을 관통하여 코팅 처리를 해주어 모발의 수분 함량을 유지하고 자외선으로 인한 손상을 완화시켜줍니다 .

#### ▶ 메모

다음에 설명된 특징을 가진 사람에게서는 이온 효과가 크게 나타나지 않을 수 있습니다 .

- 원래 굵슬 머리를 가진 사람 .
- 모발이 쉽게 말리는 사람 .
- 얇고 술이 많은 모발 .
- 3 - 4 개월 사이에 스트레이트 파마를 한 경우 .
- 짧은 모발 .

## nanoe™ 충전 패널

nanoe™/ 백금 이온이 모발에 계속해서 부딪히면 모발이 음전하를 띠게 됩니다. 그 결과 nanoe™/ 백금 이온과 음전하를 띠는 모발이 서로 밀어내어 nanoe™/ 백금 이온이 모발에 도달하기 어려워집니다.

nanoe™ 전하 시스템에서 핸들과 패널을 잡아 오므리면 머릿결에 쌓인 음 전하가 방출됩니다.

이 때문에 nanoe™/ 백금 이온이 계속해서 머리카락에 침투하여 수분을 공급하고 머리 끝까지 충분한 보습 효과를 주게 됩니다.

## 모발건조기 관리

- 스위치를 끄고 가정용 콘센트에서 전원 플러그를 분리하도록 하십시오. ( 공기 배출구 관리를 수행하는 경우는 제외 )

## 헤어 드라이어 관리

부드러운 천에 수돗물 또는 비눗물을 적셔 하우스징을 청소하십시오.

### ▶ 메모

- 희석제, 벤젠, 알코올 또는 기타 화학제품은 사용하지 마십시오.
  - 이렇게 하면 드라이어가 고장나고 부품 등이 파손 / 변형될 수 있습니다.
- 헤어 드라이어의 핸들 또는 본체에 모발 관리 제품이나 메이크업 잔류물이 남아 있으면 플라스틱이 손상되어 변색 또는 파손되거나 고장날 수 있습니다.

## nanoe™ 배출구 관리

- 시중에서 구입할 수 있는 면봉을 사용하십시오. ( 얇은 유아용 면봉을 사용하는 것이 좋습니다. )
- 이러한 관리를 통해 헤어 드라이어에서 오랜 시간 동안 생성된 nanoe™의 수준을 유지할 수 있습니다.

- 면봉 끝에 물을 적시십시오.
- 바늘 부분은 nanoe™ 배출구 내의 깊숙한 곳에 있습니다. 면봉을 사용하여 이 부분은 약 5 번 정도 부드럽게 문지르십시오.

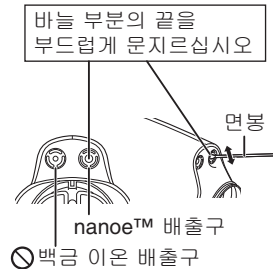

백금 이온 배출구 (C) 는 세척하지 마십시오. ( 이 배출구는 면봉을 넣기 힘든 구조로 되어 있습니다. ) 이렇게 하면 백금 이온을 방출하는 기능이 저하될 수 있습니다.

## 공기 입구 관리

티슈로 공기 입구에서 보풀, 머리카락 또는 그 밖의 이물질을 닦아내십시오.

- 손톱이나 기타 날카로운 물체로 공기 입구를 누르거나 문지르지 마십시오. 이렇게 하면 공기 입구가 손상될 수 있습니다.

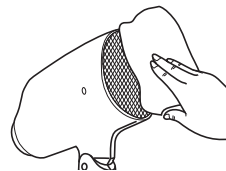

## 공기 배출구 관리

- 공기 배출구를 관리할 경우에만 모발건조기를 가정용 콘센트에 꽂아야 합니다 .
- 시중에서 구입할 수 있는 칫솔을 사용하십시오 .
- 칫솔로 문지를 때 풍온 장치를 “Cool ( 찬 공기 )” 위치로 밀어서 싸여 있는 먼지 등을 제거하십시오 .
- 관리하는 동안 손 등으로 공기 입구를 막지 않도록 주의하십시오 .
- 관리 후 헤어 드라이어를 처음으로 사용하는 경우 먼지 등이 나올 수 있으므로 주의하십시오 .

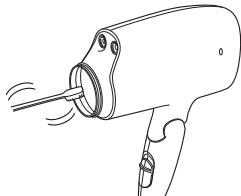

망을 막고 있는 모든 먼지와 머리카락을 문질러서 제거하십시오 .

## 문제 해결

문제	가능한 원인	조치
<p>“Hot ( 뜨거운 공기 )” 모드에서 사용할 때 자주 차가운 공기로 바뀌거나 본체 내부에서 스파크가 발생합니다 . ( 이러한 스파크는 온도 조절 스위치 , 보호 장치에 의한 것으로 고장이 아닙니다 .)</p>	<p>▶ 보풀이 공기 입구 또는 공기 배출구에 축적되었습니다 .</p> <p>▶ 머리카락이나 기타 이물질이 공기 입구를 막고 있습니다 .</p>	<p>▶ 축적되어 있는 보풀을 제거하십시오 .</p> <p>▶ 공기 입구를 막지 마십시오 .</p>
<p>뜨거운 공기가 비정상적으로 뜨겁습니다 .</p>	<p>▶ 가정용 콘센트와의 연결이 헐거워졌습니다 .</p>	<p>▶ 꼭 맞는 가정용 콘센트를 사용하십시오 .</p>
<p>nanoe™ 배출구 내에서 스파크가 발생합니다 .</p>	<p>▶ 더러워진 전극 ( 니들 부분 ) 에 의한 이상입니다 .</p>	<p>▶ nanoe™ 배출구 관리를 수행하십시오 .</p>
<p>nanoe™ 배출구에서 소음 ( 탁탁하는 소리 ) 이 납니다 .</p>	<p>▶</p>	<p>▶</p>

그래도 문제가 해결되지 않으면 제품을 구입한 매장이나 Panasonic 공인 서비스 센터에 연락하여 수리를 받으십시오 .

## 사양

제품 이름	모발건조기		
제품 모델	EH-NA45		
전원	220 V ~ 50-60 Hz	230 V ~ 50-60 Hz	240 V ~ 50-60 Hz
전력 소비	1350 W	1500 W	1600 W
부속품	고속 건조 노즐, 세팅 노즐		

본 제품은 가정에서만 사용할 수 있습니다.

품명 : Hair Dryer

모델명 : EH-NA45

상호명 : **Panasonic Manufacturing (Thailand) Co., Ltd.**

제조사 : **Panasonic Manufacturing (Thailand) Co., Ltd.**

Made in Thailand

제조일자 : 제품내 별도각인표시



KCC-REM-XXX-EH-NA45



## สารบัญ

ข้อควรระวังด้านความปลอดภัย.....	34	แผงชาร์จ nanoe™ .....	39
การจำแนกส่วนต่างๆ .....	37	การบำรุงรักษาเครื่องเป่าผม .....	39
วิธีใช้เครื่องเป่าผม .....	38	วิธีการแก้ปัญหา.....	41
เกี่ยวกับ nanoe™ .....	38	รายละเอียด.....	41
เกี่ยวกับแพลทิหุ้มไอออน .....	39		

ขอขอบคุณที่สั่งซื้อผลิตภัณฑ์ของ Panasonic

ก่อนใช้งานเครื่องนี้ โปรดอ่านคู่มือการใช้งานโดยละเอียดและเก็บรักษาคู่มือนี้ไว้เพื่อใช้งานในอนาคต

nanoe™ เป็นเครื่องหมายการค้าของ Panasonic Corporation  
nanoe™ คือ อนุภาคประจุขนาดนาโนที่เคลือบอยู่กับอนุภาคของน้ำ

## ข้อควรระวังด้านความปลอดภัย

เพื่อลดความเสี่ยงจากการบาดเจ็บ การเสียชีวิต ไฟฟ้าช็อต ไฟไหม้ การทำงานที่ผิดปกติ และความเสียหายต่ออุปกรณ์หรือทรัพย์สิน ควรศึกษาข้อควรระวังด้านความปลอดภัยต่อไปนี้เสมอ

## คำอธิบายของสัญลักษณ์ต่าง ๆ

สัญลักษณ์ต่อไปนี้ใช้เพื่อจำแนกกลุ่มและอธิบายถึงระดับของอันตราย การบาดเจ็บ และความเสียหายต่อทรัพย์สินอันเนื่องมาจากการละเลยต่อคำเตือนที่ระบุไว้ และการใช้งานอย่างไม่เหมาะสม

### คำเตือน

อันตรายที่อาจเกิดขึ้นนั้น อาจส่งผลให้ได้รับบาดเจ็บอย่างร้ายแรงหรือเสียชีวิตได้

### ข้อควรระวัง

อันตรายที่อาจส่งผลให้ได้รับบาดเจ็บเล็กน้อย

สัญลักษณ์ต่อไปนี้ใช้เพื่อจำแนกกลุ่มและอธิบายถึงประเภทของคำแนะนำที่ต้องสังเกต



สัญลักษณ์นี้ใช้เพื่อแจ้งเตือนผู้ใช้ถึงขั้นตอนการทำงานบางลักษณะที่ห้ามใช้งาน



สัญลักษณ์นี้ใช้เพื่อแจ้งเตือนผู้ใช้ถึงขั้นตอนการทำงานบางลักษณะที่ต้องปฏิบัติตามลำดับ เพื่อให้การใช้งานอุปกรณ์มีความปลอดภัย

## คำเตือน



อย่าเก็บไว้ใกล้มือเด็ก หรือทารก ไม่อนุญาตให้เด็กใช้งานเครื่อง  
- การกระทำเช่นนั้น อาจก่อให้เกิดไฟลวก ไฟฟ้าช็อต หรือได้รับบาดเจ็บได้

อย่าตัดแปลง แยกชิ้นส่วน หรือซ่อมแซม



- การกระทำเช่นนั้น อาจก่อให้เกิดประกายไฟ หรือได้รับบาดเจ็บอันเนื่องมาจากการใช้งานที่ผิดปกติ  
ติดต่อศูนย์บริการที่ได้รับอนุญาตเพื่อซ่อมแซม



อย่าทำให้เกิดความเสียหาย หรือตัดแปลง หรืออืด หรือบิดสายไฟแรงๆ

อย่าวางสิ่งของที่มีน้ำหนักมาก หรือกดสายไฟ

- การทำเช่นนั้นอาจทำให้เกิดไฟฟ้าช็อต หรือไฟไหม้เนื่องจากไฟฟ้าลัดวงจรได้



อย่าใช้ในขณะที่สายไฟม้วนรวมกันอยู่

- การกระทำเช่นนั้น อาจก่อให้เกิดไฟไหม้ หรือไฟฟ้าช็อตได้

ในการเก็บอุปกรณ์อย่าพันสายไฟเข้ากับตัวเครื่อง



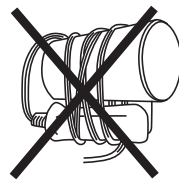



- การกระทำเช่นนั้น อาจทำให้เส้นลวดภายในสายไฟขาดและอาจทำให้ไฟไหม้เนื่องจากไฟฟ้าลัดวงจรได้





อย่าใช้งานเมื่อปลั๊กไฟ หรือ สายไฟร้อนหรือเสียหาย

- การทำเช่นนั้นอาจทำให้เกิดการไหม้ ไฟฟ้าช็อต หรือไฟไหม้เนื่องจากไฟฟ้าลัดวงจรได้

## คำเตือน

-  อย่าใช้อุปกรณ์หากปลั๊กไฟหลวมเมื่อเสียบเข้าเต้ารับภายในบ้าน
  - การทำเช่นนั้นอาจทำให้เกิดการไหม้ ไฟฟ้าช็อต หรือไฟไหม้เนื่องจากไฟฟ้าลัดวงจรได้
-  อย่าใช้มือที่เปียกเสียบหรือถอดปลั๊กไฟเข้ากับเต้ารับภายในบ้าน
  - การทำเช่นนั้นอาจทำให้เกิดไฟฟ้าช็อต หรือเกิดการบาดเจ็บได้
-  อย่าใช้อุปกรณ์ในขณะที่มือเปียกน้ำ
  - การทำเช่นนั้นอาจทำให้เกิดไฟฟ้าช็อต หรือไฟไหม้เนื่องจากไฟฟ้าลัดวงจรได้
-  อย่าเปิดสวิตช์ที่ตัวผลิตภัณฑ์ทิ้งไว้
  - เนื่องจากอาจทำให้เกิดเพลิงไหม้ได้
-  อย่าเก็บอุปกรณ์ไว้ในห้องน้ำ หรือไว้ในที่ที่มีความชื้นสูง และอย่าวางอุปกรณ์ไว้ในที่ที่อาจมีน้ำหกได้ (เช่น บนโต๊ะเครื่องแป้ง)
  - การกระทำเช่นนั้น อาจทำให้เกิดไฟฟ้าช็อต หรือไฟไหม้ได้
-  อย่าปิด สอดเข็ม หรือสิ่งแปลกปลอมเข้าไปในช่องอากาศเข้าช่องอากาศออก ช่องปล่อย nanoe™ หรือ ช่องปล่อยแพลททินั่มไอออน
  - การกระทำเช่นนั้น อาจก่อให้เกิดไฟไหม้ ไฟฟ้าช็อต หรือไฟลวกได้
-  ห้ามใช้อุปกรณ์ในบริเวณใกล้เคียงกับวัสดุที่ติดไฟได้ (เช่น แอลกอฮอล์ น้ำมันเบนซิน กีนเนอร์ สเปรย์ ผลิตภัณฑ์ดูแลผม น้ำยาล้างเล็บ)
  - การกระทำเช่นนั้น อาจก่อให้เกิดการระเบิด หรือไฟไหม้ได้

-  อย่าจุ่มอุปกรณ์นี้ในน้ำ
-  อย่าใช้เครื่องเป่าผมใกล้หน้า
- ห้าม ใช้เครื่องเป่าผมนี้ใกล้อ่างอาบน้ำ ผักบัว หรือ อ่างล้างหน้า หรือภาชนะบรรจุน้ำอื่น ๆ
  - การกระทำเช่นนั้น อาจทำให้เกิดไฟฟ้าช็อต หรือไฟไหม้ได้



สัญลักษณ์บนเครื่องเป่าผมนี้หมายถึง “ห้ามใช้เครื่องเป่าผมใกล้หน้า”

หยุดการใช้งานทันทีและถอดปลั๊กไฟออก

หากพบว่าอุปกรณ์มีการใช้งานที่ผิดปกติหรือไม่ทำงาน

- การไม่ปฏิบัติตามเช่นนั้น อาจก่อให้เกิดไฟไหม้ ไฟฟ้าช็อต หรือได้รับบาดเจ็บได้



<กรณีที่อุปกรณ์ใช้งานผิดปกติ หรือไม่ทำงาน>

- ไม่มีลมออกมา
- ตัวเครื่องหยุดการทำงานเป็นช่วง ๆ
- ภายในตัวเครื่องร้อนมาก และมีควันลอยออกมา
- ให้ติดต่อเพื่อขอตรวจสอบ หรือซ่อมแซมที่ศูนย์บริการที่ได้รับอนุญาตทันที



ใช้เต้ารับไฟภายในบ้านเพียงอย่างเดียว: อย่าใช้สายไฟพ่วง

- การไม่ปฏิบัติตามเช่นนั้น อาจก่อให้เกิดไฟไหม้ หรือไฟฟ้าช็อตได้



เสียบปลั๊กไฟให้แน่น

- การไม่ปฏิบัติตามเช่นนั้น อาจก่อให้เกิดไฟไหม้ หรือไฟฟ้าช็อตได้

ตรวจสอบให้แน่ใจว่า อุปกรณ์ทำงานจากแหล่งจ่ายไฟฟ้าที่ตรงกับ



อัตราแรงดันไฟฟ้าที่ระบุไว้บนตัวอุปกรณ์

- การไม่ปฏิบัติตามเช่นนั้น อาจทำให้เกิดไฟไหม้ ไฟฟ้าช็อต หรือผลจากไฟไหม้ได้

## ⚠ คำเตือน

❗ เมื่อคุณเห็นประกายไฟรอบ ๆ ช่องอากาศออกในขณะที่ตั้งค่าลมร้อน ให้หยุดการใช้งาน และนำเส้นใยออกจากช่องอากาศออก และ ช่องอากาศเข้า

- การไม่ปฏิบัติตามวิธีการดังกล่าว อาจก่อให้เกิดบาดเจ็บจากไฟลวก หรือไฟไหม้ได้

❗ ปิดสวิตช์เปิดปิดและถอดปลั๊กไฟออกจากตัวรับไฟภายในบ้านหลังการใช้งานเสมอ

- การไม่ปฏิบัติตามเช่นนั้น อาจก่อให้เกิดไฟไหม้ หรือไฟลวกได้

❗ ถอดปลั๊กไฟโดยการจับที่ตัวปลั๊ก แทนการดึงที่สายไฟ

- การไม่ปฏิบัติตามเช่นนั้น อาจทำให้เส้นลวดภายในสายไฟขาด และอาจก่อให้เกิดไฟลวก หรือไฟช็อต หรือไฟไหม้ขึ้นเนื่องมาจากไฟฟ้าลัดวงจรได้

❗ ทำความสะอาดปลั๊กไฟอย่างสม่ำเสมอเพื่อป้องกันฝุ่นผงสะสม

- การหากไม่ปฏิบัติตามเช่นว่านั้น อาจทำให้ฉนวนใช้งานไม่ได้เนื่องจากความชื้น ถอดปลั๊กไฟและเช็ดด้วยผ้าแห้ง

❗ เมื่อใช้เครื่องเป่าผมในห้องน้ำ ให้ถอดปลั๊กหลังใช้งาน เพราะบริเวณที่ใกล้น้ำอาจเป็นอันตราย แม้จะปิดสวิตช์เครื่องแล้ว

- การไม่ปฏิบัติตามเช่นว่านั้น อาจทำให้เกิดอุบัติเหตุ หรือการบาดเจ็บได้

❗ เพื่อเพิ่มการป้องกัน ขอแนะนำให้ติดตั้งอุปกรณ์ป้องกันไฟลัดวงจร (RCD) ที่มีค่ากระแสไฟฟ้าที่รั่วตามกำหนดไม่เกิน 30 มิลลิแอมแปร์

สำหรับวงจรไฟฟ้าที่ใช้ในห้องน้ำ หรือสอบถามคำแนะนำจากผู้ติดตั้ง

- การไม่ปฏิบัติตามเช่นว่านั้น อาจทำให้เกิดอุบัติเหตุ หรือการบาดเจ็บได้

❗ อุปกรณ์นี้ไม่ได้ผลิตขึ้นมาสำหรับบุคคล (รวมถึงเด็ก ๆ) ที่มีร่างกาย ประสาทรับความรู้สึก หรือสภาพทางจิตใจบกพร่อง หรือขาดประสบการณ์และความรู้ เว้นแต่จะได้รับการดูแลหรือคำแนะนำเกี่ยวกับการใช้งานอุปกรณ์นี้ โดยผู้ดูแล

ความปลอดภัยของพวกเขา ควรดูแลไม่ให้เด็กนำอุปกรณ์นี้มาเล่น

- การไม่ปฏิบัติตามเช่นว่านั้น อาจทำให้เกิดอุบัติเหตุ หรือการบาดเจ็บได้

❗ หากสายไฟที่ไหม้เกิดชำรุด ต้องนำไปเปลี่ยนกับผู้ผลิต ศูนย์บริการ หรือผู้ให้บริการลักษณะเดียวกันเพื่อป้องกันการเกิดอันตราย

- การไม่ปฏิบัติตามเช่นว่านั้น อาจทำให้เกิดอุบัติเหตุ หรือการบาดเจ็บได้

## ⚠ ข้อควรระวัง

❗ อย่าเก็บสายไฟโดยการม้วนหรือบิด

❗ - การกระทำเช่นนั้น อาจทำให้เส้นลวดภายในสายไฟขาดและอาจทำให้ไฟไหม้ เนื่องจากไฟฟ้าลัดวงจรได้

❗ อย่าทำตก หรือทำให้ได้รับแรงกระแทก

- การทำเช่นนั้นอาจทำให้เกิดไฟฟ้าช็อต หรือเกิดประกายไฟได้

❗ อย่าใช้งานหากช่องอากาศเข้าได้รับความเสียหาย

- ผมของคุณอาจค้างอยู่ในช่องอากาศเข้าซึ่งอาจก่อให้เกิดความเสียหายต่อเส้นผมได้

❗ อย่าสัมผัสช่องอากาศออก พวยเป่าผมแห้งเร็ว และ ชุดพวยเป่าผม ที่ร่อนจัด

- การกระทำเช่นนั้น อาจก่อให้เกิดไฟลวกได้

❗ อย่าใช้อุปกรณ์นี้กับเด็ก หรือทารก

- การกระทำเช่นนั้น อาจก่อให้เกิดไฟลวกได้

ในขณะที่ดึงหรือพับตามจับอย่าสัมผัสบริเวณที่แรงจางตามที่ปรากฏตามรูปภาพที่แสดงไว้ด้านล่าง

- เนื่องจากอาจก่อให้เกิดการบาดเจ็บที่นิ้วมือได้

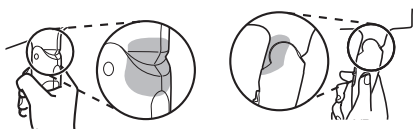

## ⚠️ ข้อควรระวัง

ระมัดระวังเกี่ยวกับจุดที่ใช้งานเครื่องเป่าผม

❗ และตรวจสอบว่าได้เว้นระยะห่างอย่างน้อย 10 ซม. ระหว่างเส้นผมกับช่องอากาศเข้า

- ผมของคุณอาจค้างอยู่ในช่องอากาศเข้าซึ่งอาจก่อให้เกิดความเสียหายต่อเส้นผมได้

❗ โปรดรักษาระยะห่างมากกว่า 3 ซม. ระหว่างช่องอากาศออกและเส้นผม

- การไม่ปฏิบัติตามดังกล่าวอาจทำให้เส้นผมไหม้ได้

❗ อย่าใช้เครื่องเป่าผมกับสัตว์เลี้ยง หรือเป่าเสื้อผ้า รองเท้า ฯลฯ

- การไม่ปฏิบัติตามเช่นนั้น อาจก่อให้เกิดไฟไหม้หรือไฟลวกได้

### ► หมายเหตุ

- เครื่องเป่าผมนี้มีอุปกรณ์ตัดไฟอัตโนมัติ เพื่อป้องกันความร้อนที่สูงเกิน หากเครื่องเป่าผมเกิดความร้อนที่สูงเกินไป เครื่องจะสับสวิตซ์ไปเป็นระบบเป่าลมเย็น ให้เปิดสวิตซ์เครื่องเป่าผมและถอดปลั๊กออกจากแหล่งจ่ายไฟ
- ปล่อยให้เครื่องเป่าผมเย็นลงประมาณ 2 - 3 นาที แล้วจึงเริ่มใช้งานอีกครั้ง ตรวจสอบให้แน่ใจว่าไม่มีเส้นผม เศษผม หรืออื่นๆ ติดอยู่ในช่องอากาศเข้า และช่องอากาศออก ก่อนเปิดสวิตซ์อีกครั้ง
- ท่านอาจจะได้ยิน ขณะกำลังใช้งานเครื่องเป่าผม ซึ่งเกิดจากไอโซนที่สร้างขึ้น ซึ่งไม่เป็นอันตรายต่อร่างกายมนุษย์

## การจำแนกส่วนต่างๆ

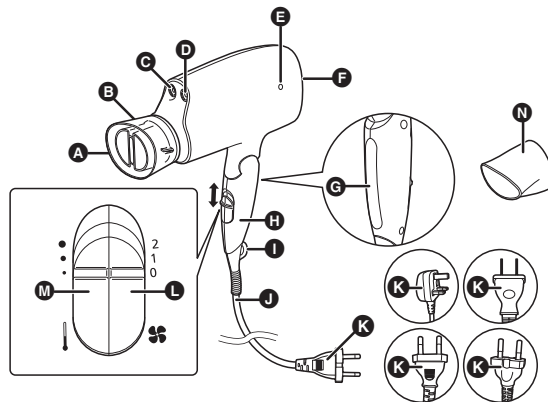

- A** ช่องอากาศออก
  - B** พวยเป่าผมแห้งเร็ว
  - C** ช่องปล่อยแพลทินัมไอออน
  - D** ช่องปล่อย nanoe™
  - E** ไฟ nanoe™
  - F** ช่องอากาศเข้า
  - G** แฉงชาร์จ nanoe™
  - H** คัมจับ
  - I** ห่วงสำหรับแขวน
  - J** สายไฟ
  - K** ปลั๊กไฟ
  - L** สวิตซ์เปิดปิด ( )
    - 2: Dry (ลมแรง)
    - 1: Set (ลมเบา)
    - 0: Off (ปิด)
  - M** ตัวปรับอุณหภูมิ ( )
    - : Hot (ลมร้อน)
    - : Healthy (ลมอุ่น)
    - : Cool (ลมเย็น)
  - N** ชุดพวยเป่าผม
- (รูปทรงของปลั๊กไฟอาจแตกต่างกันในแต่ละพื้นที่)

### ▶ พวยเป่าผมแห้งเร็ว

เพื่อให้ผมแห้งเร็วมากขึ้น

ติดตั้งพวยเป่าผมแห้งเร็วซึ่งจะทำให้ช่องอากาศออกตั้งขึ้น

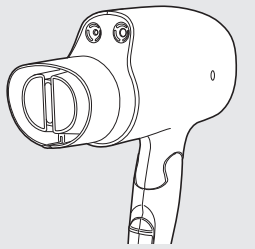

### ▶ ชุดพวยเป่าผม

สำหรับการจัดแต่งทรงผมถูกต้องสวยงาม

- อาจมีหยดน้ำออกจากช่องปล่อย **nanoe™ (D)** ขณะทำงาน แต่ไม่ใช่การทำงานผิดปกติ
- อาจเกิดเสียงรบกวนเบาๆ ออกจากช่องปล่อย **nanoe™ (D)** แต่นี้เป็นเสียงของ **nanoe™** ที่กำลังคายประจุและไม่ใช่การทำงานผิดปกติ
- การทำงานของ **nanoe™** อาจไม่สามารถรู้สึกได้ในกลุ่มคนต่อไปนี้ได้แก่ กลุ่มคนที่ผมหยิก ผมหยักเป็นคลื่นมาก ผมเรียบ ตรงมาก ผมสั้น หรือคนที่ยึดผมในระยะสามถึงสี่ เดือนที่ผ่านมา
- ห้ามฉีดสเปรย์ใกล้กับเครื่องเป่าผมในระหว่างการใช้งาน ส่วนประกอบในสเปรย์อาจถูกดูดเข้าไปในเครื่องเป่าผม ซึ่งจะส่งผลให้การทำงานเสื่อมประสิทธิภาพลงได้

## เกี่ยวกับ nanoe™

### nanoe™ คืออะไร?

(กระบวนการสร้าง **nanoe™**: การปล่อยประจุที่มีแรงดันไฟฟ้าสูง)  
**nanoe™** คือ อนุภาคของน้ำขนาดเล็กเกิดขึ้นโดยใช้แรงดันไฟฟ้าสูงเพื่อแยกน้ำออกจากกัน เส้นผ่าศูนย์กลางของมันเป็นเล็กกว่า 1/100 ของไอน้ำ ทำให้สามารถมองเห็นได้ด้วยตาเปล่า เนื่องจาก **nanoe™** ถูกสร้างขึ้นจากการผสมน้ำในอากาศ ดังนั้น จึงเป็นเรื่องยากที่จะสร้างในบางกรณี ทั้งนี้ขึ้นอยู่กับสภาพแวดล้อม (การผสมน้ำในอากาศที่มีความชื้นและมีความชื้นต่ำสามารถทำได้ยาก)

### ลักษณะการทำงานของ nanoe™

โดยปกติเส้นผมมีคุณสมบัติทำให้เป็นประจุบวกได้ง่ายด้วยไฟฟ้า และคุณสมบัตินี้ทำให้ **nanoe™** ที่มีค่าเป็น ลบ เข้าแทรกซึมเข้าสู่เส้นผมพร้อมกับความชุ่มชื้น จากนั้นจะทำให้เส้นผมมีคุณสมบัติเป็น กรดอ่อนๆ ซึ่งช่วยให้หนังศีรษะแข็งแรง และเส้นผมมีความยืดหยุ่น และมีสุขภาพดี

## วิธีใช้เครื่องเป่าผม

**1** เลือกอุณหภูมิของความแรงลมด้วยตัวปรับอุณหภูมิ (M)

**2** เลือกระดับของความแรงลมด้วยสวิตช์เปิดปิด (L)

### ▶ หมายเหตุ

- หากคุณใช้ลมเย็นเพื่อเป่าผมของคุณให้แห้ง เลื่อนสวิตช์เปิดปิด (L) ไปยังตำแหน่ง "1" หรือ "2" และตั้งตัวปรับอุณหภูมิไปยังตำแหน่ง "● : Cool (ลมเย็น)"
- เมื่อเลื่อนสวิตช์เปิดปิด (L) ไปยังตำแหน่ง "1" และ "2" เครื่องจะปล่อย **nanoe™** และแพลทินั่มไอออน
- **nanoe™** และแพลทินั่มไอออนไม่สามารถมองเห็นได้ด้วยตาเปล่า
- ใช้ชุดพวยเป่าผม (N) เพื่อให้ลมพุ่งไปยังที่เดียว
- ถ้าท่านกังวลว่าเส้นผมจะแห้งเสีย ให้ตั้งสวิตช์ไปที่ "1: SET(ลมเบา)" ก่อนใช้งาน

## เกี่ยวกับแพลทินัมไอออน

### แพลทินัมไอออนคืออะไร?

กระบวนการสร้างแพลทินัมไอออน: การปล่อยประจุที่มีแรงดันไฟฟ้าสูง

ไอออน คือ อนุภาคที่รวมออกซิเจนที่เป็นประจุลบกับความชุ่มชื้นในอากาศ แพลทินัมไอออนสร้างมาจากอิเล็กโทรดแพลทินัม

ไอออนเหล่านี้ไม่สามารถมองเห็นได้ด้วยตาเปล่า เนื่องจากมีเส้นผ่านศูนย์กลางที่เล็กกว่า 1/1000 ของอนุภาคของไอน้ำ

### แพลทินัมไอออนทำงานอย่างไร

โดยปกติแล้ว หมอของเราจะมีประจุบวก โดยการทำให้หมเปลี่ยนเป็นประจุลบด้วยแพลทินัมไอออน จะทำให้ค่าไฟฟ้าสถิตบนผมเปลี่ยนเป็นกลาง และทำให้ผมนุ่มลื่นขึ้น

แพลทินัมไอออนไม่เพียงแต่จะแทรกซึมเข้าไปยังเส้นผมแต่ละเส้นเท่านั้น แต่ยังเคลือบผม และช่วยรักษาความชุ่มชื้น และปกป้องเส้นผมจากการถูกทำลายโดยรังสียูวีอีกด้วย

#### ► หมายเหตุ

บุคคลดังต่อไปนี้เมื่อใช้ไอออนแล้วอาจไม่เกิดผลมากเท่าที่ควร

- ผู้ที่มีผมหยิกธรรมชาติ
- ผู้ที่มีผมมันได้ง่าย
- ผู้ที่มีผมที่หมดและจัดทรงดีอยู่แล้ว
- ผู้ที่ทำการยืดผมมาภายใน 3 - 4 เดือน
- ผู้ที่มีผมสั้น

## แผงชาร์จ nanoe™

เมื่อ nanoe™/แพลทินัมไอออนปะทะเข้าสู่ผม จะทำให้ผมกลายเป็นประจุลบ ผลก็คือ nanoe™/แพลทินัมไอออนจะผลักผมออกจากกัน ซึ่งจะทำให้ nanoe™/แพลทินัมไอออนยากที่จะเข้าถึงเส้นผม ด้วยระบบชาร์จ nanoe™ เพียงจับแผงชาร์จประจุ และด้ามจับ จะทำให้ประจุลบที่สะสมอยู่บนเส้นผมคลายออก ด้วยเหตุดังกล่าว nanoe™/แพลทินัมจะแทรกซึมเข้าสู่เส้นผมต่อไปได้ ช่วยเพิ่มความชื้นได้ทั่วไปจนถึงปลายเส้นผม

## การบำรุงรักษาเครื่องเป่าผม

- ตรวจสอบว่าได้ปิดสวิทช์เปิดปิดและถอดปลั๊กไฟออกจากตัวรับไฟภายในบ้านหลังการใช้งานเสมอ (เว้นแต่ขณะที่ทำการบำรุงรักษาช่องอากาศออก)

## การบำรุงรักษาเครื่องเป่าผม

ทำความสะอาดที่โกนหนวดด้วยผ้าที่ชุบน้ำหรือน้ำผสมสบู่พอกพาดู

#### ► หมายเหตุ

- ห้ามใช้ทินเนอร์ เบนซิน แอลกอฮอล์ หรือสารเคมีอื่นๆ
  - การทำดังกล่าวอาจทำให้เครื่องทำงานผิดปกติ ชิ้นส่วนแตกร้าว/เปลี่ยนสีได้ เป็นต้น
- การปล่อยให้เครื่องเป่าผมยังคงมีผลิตภัณฑ์ที่ใช้กับเส้นผมหรือเครื่องสำอางติดอยู่กับด้ามจับ หรือตัวเครื่องอาจทำให้พลาสติกเสื่อมสภาพเป็นผลทำให้บริเวณดังกล่าวเปลี่ยนสีหรือแตกร้าว และทำงานผิดปกติได้

## การบำรุงรักษาช่องปล่อย nanoe™

- ใช้ก้านสำลีที่หาซื้อได้ทั่วไป  
(เราขอแนะนำให้ใช้ก้านสำลีขนาดเล็กที่ผลิตขึ้นเพื่อใช้กับเด็กทารก)
  - การบำรุงรักษาในส่วนนี้จะช่วยให้เครื่องเป่าผมรักษาระดับของ nanoe™ ที่ถูกสร้างขึ้นไว้ได้เป็นเวลานาน
- แช่ปลายก้านสำลีในน้ำให้เปียกชุ่ม
  - ส่วนที่เป็นหัวเข็มจะยกลึกลงไปในช่องปล่อย nanoe™ ใช้ก้านสำลีถูตรงส่วนนี้เบาๆ ประมาณ 5 ครั้ง

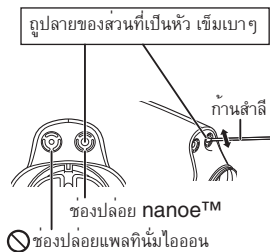

อย่าพยายามทำความสะอาดช่องปล่อยแพลทินัมไอออน (Ⓢ)  
(ช่องปล่อยไอออนมีโครงสร้างที่ยากต่อการสอดสำลีพันปลายไม้เข้าไปเช็ด  
การกระทำดังกล่าวอาจทำให้สูญเสียความสามารถในการปล่อย แพลทินัมไอออน

## การบำรุงรักษาช่องอากาศเข้า

เช็ดเส้นใย ผม หรือชิ้นส่วนอื่นๆ

จากช่องอากาศเข้าด้วยกระดาษทิชชู

- อย่ากดหรือถูช่องอากาศเข้าด้วยเล็บ  
หรือวัตถุปลายแหลมอื่นๆ

เนื่องจากอาจก่อให้เกิดความเสียหายต่อช่องอากาศเข้า

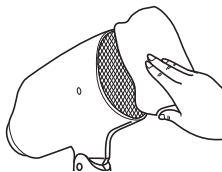

## การบำรุงรักษาช่องอากาศออก

- ควรเสียบปลั๊กเครื่องเป่าผมเข้ากับเต้ารับไฟภายในบ้านในกรณีที่ทำกรบำรุงรักษาช่องอากาศออกเท่านั้น
- ใช้แปรงสีฟันที่หาซื้อได้ทั่วไป
- เปลี่ยนตัวปรับอุณหภูมิไปที่ "Cool (ลมเย็น)" และเป่าฝุ่นผงหรือสิ่งอื่นๆ ออกในขณะที่ท่านใช้แปรงสีฟันขัดดู
- ในระหว่างการบำรุงรักษาอย่าให้มือของท่านหรือสิ่งอื่นๆ กีดขวางช่องอากาศเข้า
- ระมัดระวังเมื่อใช้เครื่องเป่าผมเป็นครั้งแรกหลังจากทำการบำรุงรักษา เนื่องจากเครื่องอาจเป่าฝุ่นผงหรือสิ่งอื่นๆ ออกมา

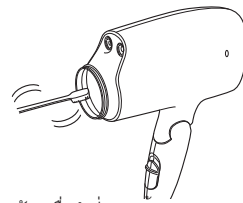

ขัดดูเพื่อนำฝุ่นผง เส้นผม ฯลฯ  
ที่ติดอยู่กับตระแกรงออกมา

## วิธีการแก้ปัญหา

ปัญหา	สาเหตุที่เป็นไปได้	การแก้ไข
เปลี่ยนไปเป็นลมเย็นน้อยเกินไปในระหว่างการใช้งานในโหมด "Hot (ลมร้อน)" หรือมองเห็นประกายไฟภายในตัวเครื่อง (ประกายไฟอาจมีสาเหตุมาจากสวิตช์ควบคุมอุณหภูมิอุปกรณ์ป้องกันเครื่อง และกรณีเช่นนี้ไม่ได้ผิดปกติ)	มีเส้นใยสะสมในช่องอากาศเข้า หรือ ช่องอากาศออก ผม หรือสิ่งอื่นๆ อุดตันในช่องอากาศเข้า	นำเส้นใยที่สะสมอยู่ออก อย่าปิดช่องอากาศเข้า
ลมร้อนร้อนมากผิดปกติ		
ปลั๊กไฟร้อนผิดปกติ	เสียบปลั๊กเข้ากับเต้ารับไฟภายในบ้านไม่แน่น	ใช้เต้ารับไฟภายในบ้านที่มีขนาดพอดี
มีประกายไฟเกิดขึ้นภายในช่องปล่อย nanoe™		
ช่องปล่อย nanoe™ มีเสียงดัง (เสียงแตกหัก)	ความผิดปกติอาจเกิดจากความสกรกของอิเล็กทรอนิกส์ (ส่วนเสริม)	ทำการบำรุงรักษาช่องปล่อย nanoe™

หากปัญหาเหล่านี้ยังคงไม่สามารถแก้ไขได้ ติดต่อร้านที่คุณซื้อเครื่องเป่าผมนี้ หรือศูนย์บริการที่ได้รับอนุญาตจาก Panasonic เพื่อทำการซ่อมแซม

## รายละเอียด

ชื่อผลิตภัณฑ์	เครื่องเป่าผม		
รุ่นผลิตภัณฑ์	EH-NA45		
แหล่งไฟฟ้า	220 V ~ 50-60 Hz	230 V ~ 50-60 Hz	240 V ~ 50-60 Hz
การใช้ไฟ	1350 W	1500 W	1600 W
อุปกรณ์เสริม	พวยเป่าผมแห้งเร็ว ชุดพวยเป่าผม		

สินค้าสำหรับใช้ในบ้าน



## Mục lục

<b>Các lưu ý về an toàn .....</b>	<b>44</b>	<b>Bảng nạp nanoe™ .....</b>	<b>50</b>
<b>CÁC BỘ PHẬN .....</b>	<b>48</b>	<b>Bảo trì máy sấy tóc.....</b>	<b>50</b>
<b>Cách sử dụng máy sấy tóc.....</b>	<b>48</b>	<b>Xử lý sự cố.....</b>	<b>52</b>
<b>Giới thiệu về nanoe™ .....</b>	<b>49</b>	<b>Các thông số kỹ thuật.....</b>	<b>52</b>
<b>Giới thiệu về ion platinum .....</b>	<b>49</b>		

Cảm ơn bạn đã mua sản phẩm Máy sấy tóc của Panasonic.  
Trước khi vận hành thiết bị, xin vui lòng đọc toàn bộ hướng dẫn sử dụng và lưu lại tham khảo về sau.

nanoe™ là thương hiệu của Panasonic Corporation.  
Một nanoe™ là một hạt ion có kích thước nano được bao phủ bằng các hạt nước.

## Các lưu ý về an toàn

Để giảm nguy cơ chấn thương, thiết mạng, giật điện, hỏa hoạn, sự cố và hư hỏng cho thiết bị hoặc tài sản, luôn luôn tuân thủ các biện pháp phòng ngừa an toàn sau đây.

## Giải thích các biểu tượng

Các biểu tượng sau đây được sử dụng để phân loại và mô tả các mức độ nguy hiểm, chấn thương và hư hỏng tài sản gây ra bởi việc bỏ qua các dấu hiệu đó và sử dụng không đúng quy định.



## CẢNH BÁO

Biểu hiện mỗi nguy hiểm tiềm ẩn có thể dẫn đến thương tích nghiêm trọng hoặc tử vong.



## THẬN TRỌNG

Biểu hiện một mối nguy hiểm có thể dẫn đến chấn thương nhẹ.

Các biểu tượng sau đây được sử dụng để phân loại và mô tả các loại hướng dẫn cần được tuân thủ.



Biểu tượng này được sử dụng để cảnh báo người dùng về một thao tác cụ thể không được phép thực hiện.



Biểu tượng này được sử dụng để cảnh báo người dùng về một thao tác cụ thể nên làm theo nhằm vận hành thiết bị an toàn.



## CẢNH BÁO



**Không bảo quản trong tầm với của trẻ em hoặc trẻ sơ sinh. Không được để cho trẻ sử dụng máy.**

- Làm như vậy có thể gây bỏng, giật điện, hoặc chấn thương.



**Không bao giờ được thay đổi, tháo rời, hoặc sửa chữa.**

- Làm như vậy có thể gây ra phát lửa hoặc chấn thương do việc vận hành bất thường.

Xin liên hệ với một trung tâm dịch vụ được ủy quyền để sửa chữa.



**Không được làm hư hỏng hoặc sửa đổi, dùng lực uốn cong, kéo, hoặc xoắn dây điện.**

**Ngoài ra, không được đặt bất cứ vật gì nặng lên trên hoặc kẹp dây điện.**

- Làm như vậy có thể gây điện giật hoặc cháy do chập điện.



**Không được sử dụng khi dây điện đang bị bó lại.**

- Làm như vậy có thể gây ra hỏa hoạn hoặc điện giật.

**Không được quấn dây điện chặt xung quanh thân máy khi cất giữ.**

- Làm như vậy có thể khiến lõi dây bên trong dây điện bị gãy do tải trọng, và có thể gây điện giật hoặc cháy do chập điện.

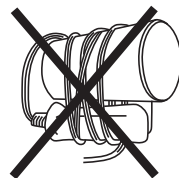



# CẢNH BÁO

**Không được sử dụng khi phích cắm hoặc dây điện bị hỏng hoặc đang nóng.**



- Làm như vậy có thể gây ra bỏng, điện giật hoặc cháy do chập điện.

**Không được sử dụng thiết bị này nếu phích cắm bị lỏng lẻo trong ổ cắm điện nhà.**



- Làm như vậy có thể gây ra bỏng, điện giật hoặc cháy do chập điện.

**Không được kết nối hoặc ngắt kết nối phích cắm với ổ cắm điện nhà khi tay đang ướt.**



- Làm như vậy có thể gây ra giật điện hoặc chấn thương.

**Không được sử dụng thiết bị khi tay đang ướt.**



- Làm như vậy có thể gây điện giật hoặc cháy do chập điện.

**Không được bỏ đi khi thiết bị đang hoạt động.**



- Làm như vậy có thể gây ra cháy.

**Không được cất thiết bị trong phòng tắm hoặc nơi có độ ẩm cao. Và, không được đặt máy ở nơi nước có thể tràn vào (chẳng hạn như bên trên bộ trong phòng tắm).**



- Làm như vậy có thể gây ra điện giật hoặc cháy.

**Không được bịt chặn, hoặc đưa ghim kẹp tóc hoặc các ngoại vật khác vào cổng hút khí, miệng thổi gió, đầu phun nanoe™, hoặc đầu phun ion platinum.**



- Làm như vậy có thể gây ra cháy, điện giật hoặc bỏng.



**Không được sử dụng gần các vật liệu dễ cháy (chẳng hạn như rượu, ét-xăng, chất pha loãng, chai xịt, sản phẩm dưỡng tóc, chai tẩy sơn móng tay).**

- Làm như vậy có thể gây ra cháy nổ.



**Không được dim thiết bị này vào nước.**

**Không được sử dụng máy sấy tóc gần nước.**

**Không sử dụng máy này gần phòng tắm, vòi hoa sen, bồn hoặc các loại thùng đựng nước khác.**

- Làm như vậy có thể gây ra điện giật hoặc cháy.



**Biểu tượng này trên máy sấy tóc có nghĩa là “Không sử dụng máy sấy tóc này ở gần nước”.**

**Ngừng sử dụng ngay lập tức và tháo phích cắm nếu có bất thường hay hư hỏng.**

- Không làm như vậy có thể gây cháy, giật điện, hoặc chấn thương.



**<Các trường hợp bất thường hay hư hỏng>**

• Máy không phát ra khí

• Máy thỉnh thoảng dừng lại

• Phần bên trong trở nên nóng đỏ và phát ra khói

- Ngay lập tức yêu cầu kiểm tra hoặc sửa chữa tại một trung tâm dịch vụ được ủy quyền.



**Chỉ sử dụng với ổ cắm điện: Không được sử dụng với dây điện nối dài.**

- Không làm như vậy có thể gây ra cháy hoặc điện giật.



**Cắm thật chặt phích cắm.**

- Không làm như vậy có thể gây ra cháy hoặc điện giật.



## CẢNH BÁO



Luôn luôn đảm bảo thiết bị vận hành với nguồn điện đúng với điện áp định mức được chỉ báo trên thiết bị.

- Không làm như vậy có thể gây cháy, giật điện, hoặc bỏng.



Khi bạn nhìn thấy các tia lửa điện xung quanh miệng thổi gió khi sử dụng cài đặt khí nóng, hãy ngừng sử dụng và gỡ bỏ xơ vải trên miệng thổi gió và cổng hút khí.

- Không làm như vậy có thể gây ra bỏng hoặc cháy.



Luôn luôn TẮT công tắc chính và ngắt phích cắm ra khỏi ổ cắm điện nhà sau khi dùng xong.

- Không làm như vậy có thể gây ra cháy hoặc bỏng.



Ngắt phích cắm bằng cách nắm giữ phích rút ra thay vì kéo dây điện.

- Không làm như vậy có thể khiến lõi dây bên trong dây điện bị gãy, và có thể gây bỏng, điện giật hoặc cháy do chập điện.



Vệ sinh thường xuyên phích cắm để ngăn ngừa bụi bám tích tụ.

- Không làm như vậy có thể gây ra cháy do độ ẩm làm hỏng lớp cách nhiệt.

Ngắt phích cắm và lau sạch bằng vải khô.



Khi sử dụng máy sấy tóc trong phòng tắm, cần rút điện của máy sấy khỏi phích cắm sau khi sử dụng để tránh rủi ro xảy ra khi máy sấy tiếp xúc gần nước ngay cả khi máy đã được tắt.

- Không làm như vậy có thể gây tai nạn hoặc chấn thương.



Đề tăng thêm sự bảo vệ, nên lắp đặt thiết bị chống giật (thiết bị RCD) để mạch điện hoạt động cung cấp trong phòng tắm không vượt quá 30 mA. Tham khảo ý kiến với người lắp đặt.

- Không làm như vậy có thể gây tai nạn hoặc chấn thương.



Thiết bị này không dành sử dụng cho những người (kể cả trẻ nhỏ) bị khiếm khuyết về tinh thần, cảm giác hoặc thể lý, hay thiếu hiểu biết và kinh nghiệm, trừ khi họ được trợ giúp hoặc được hướng dẫn về việc sử dụng máy sấy bởi người có trách nhiệm về sự an toàn của họ.

Nên trông nom trẻ em cẩn thận để chúng không dùng máy sấy để chơi đùa.

- Không làm như vậy có thể gây tai nạn hoặc chấn thương.



Nếu dây nguồn bị hỏng thì phải do nhà sản xuất, đại lý dịch vụ hoặc những nhân viên có đủ tiêu chuẩn thay thế để tránh gặp rủi ro.

- Không làm như vậy có thể gây tai nạn hoặc chấn thương.



## THẬN TRỌNG



Không được cất giữ dây điện bằng cách quấn bó lại.

- Làm như vậy có thể khiến lõi dây bên trong dây điện bị gãy do tải trọng, và có thể gây điện giật hoặc cháy do chập điện.



Không được làm rơi hoặc va chạm máy.

- Làm như vậy có thể gây ra giật điện hoặc phát lửa.



# THẬN TRỌNG

**Không được sử dụng khi cổng hút khí đang bị hư hỏng.**



- Tóc của bạn có thể bị hút vào trong cổng hút khí gây hư hỏng tóc.

**Không được chạm vào miệng thổi gió, đầu sấy khô nhanh, và đầu sấy tập trung mà thường sẽ trở nên rất nóng.**



- Làm như vậy có thể gây ra bỏng.

**Không được sử dụng cho trẻ em hoặc trẻ sơ sinh.**



- Làm như vậy có thể gây ra bỏng.

**Khi mở ra hoặc gấp tay cầm, không được chạm vào các chỗ bóng mờ như minh họa trong hình dưới đây.**

- Làm như vậy có thể gây ra chấn thương.

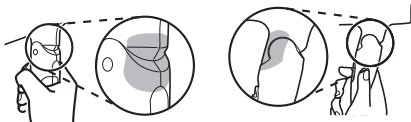

**Hãy cẩn thận về nơi bạn hướng máy sấy tóc vào, và chắc chắn để giữ tóc của bạn cách cổng hút khí ít nhất 10 cm.**



- Tóc của bạn có thể bị hút vào trong cổng hút khí gây hư hỏng tóc.

**Hãy giữ khoảng cách trên 3 cm giữa miệng thổi gió và tóc của bạn.**



- Không làm như vậy có thể làm cho tóc của bạn bị đốt cháy.



**Chỉ sử dụng để sấy khô hoặc tạo kiểu tóc cho người. (Không được sử dụng cho vật nuôi, hoặc sấy khô quần áo, giày dép, v.v...)**

- Không làm như vậy có thể gây ra cháy hoặc bỏng.

## ► Ghi chú

- Loại máy sấy tóc này có trang bị bộ phận bảo vệ chống quá nóng tự động. Nếu quá nóng, máy sẽ chuyển sang chế độ phá khí mát. Tắt máy và tháo phích cắm ra khỏi ổ cắm điện nhà. Để máy nguội trong vài phút rồi mới sử dụng lại. Kiểm tra để đảm bảo là trong cổng hút khí và miệng thổi gió không có xơ vải, tóc v.v... trước khi bật lại máy.
- Bạn có thể nghĩ thấy một mùi đặc trưng khi sử dụng loại máy sấy tóc này. Sở dĩ có mùi này là vì máy tạo ra khí ô-zôn và khí này không có hại cho cơ thể người.

## CÁC BỘ PHẬN

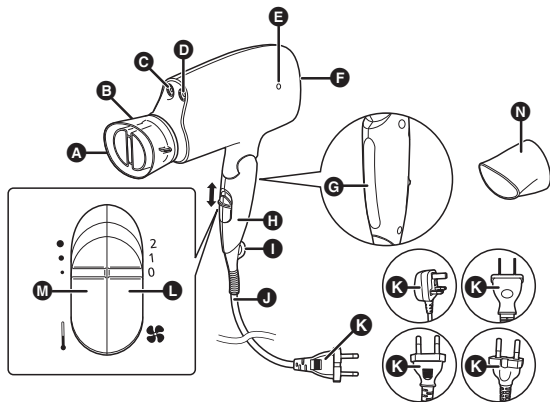

- A** Miệng thổi gió
- B** Đầu sấy khô nhanh
- C** Đầu phun ion platinum
- D** Đầu phun nanoe™
- E** Công tắc nanoe™
- F** Công hút khí
- G** Bảng nạp nanoe™
- H** Tay cầm
- I** Vòng treo
- J** Dây điện
- K** Phích cắm  
(Hình dạng phích cắm sẽ khác nhau tùy thuộc vào khu vực.)
- L** Công tắc chính (☼)  
2: Dry (Luồng khí phá mạnh)  
1: Set (Luồng khí phá nhẹ)  
0: Off (Tắt)
- M** Bộ phận chọn tốc độ (↓)  
● : Hot (Không khí nóng)  
● : Healthy (Không khí ấm)  
● : Cool (Không khí lạnh)
- N** Đầu sấy tập trung

### ► Đầu sấy khô nhanh

Để sấy khô tóc nhanh chóng

Gắn Đầu sấy khô nhanh sao cho miệng thổi gió này thẳng đứng.

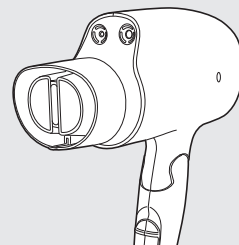

### ► Đầu sấy tập trung

Để tạo kiểu tóc chính xác

## Cách sử dụng máy sấy tóc

- 1** Chọn nhiệt độ dòng khí bằng bộ phận chọn tốc độ (M).
- 2** Chọn cường độ luồng khí bằng công tắc chính (L).

### ► Ghi chú

- Nếu bạn có thể sử dụng khí làm mát để làm khô tóc, hãy cài công tắc chính (L) sang vị trí "1" hoặc "2" và cài bộ phận chọn tốc độ sang vị trí "● : Cool (Không khí lạnh)".
- Các ion nanoe™ và platinum được tạo ra khi công tắc chính (L) được cài sang vị trí "1" hoặc "2".
- Các ion nanoe™ và platinum không thể nhìn thấy bằng mắt thường.
- Sử dụng Đầu sấy tập trung (N) để tập trung luồng khí.
- Để tránh cho tóc không bị tổn thương, bật công tắc ở vị trí "1: Set (Luồng khí phá nhẹ)" trước khi sử dụng.

- Trong khi sử dụng có thể có các giọt nước bắn ra từ đầu phun nanoe™ (D) nhưng đây không phải là do máy hư hỏng.
- Tiếng ồn nhẹ có thể phát ra từ đầu phun nanoe™ (D), nhưng đó là âm thanh của nanoe™ đang được nhả ra chứ không phải do máy bị hư hỏng.
- Những nhóm người sau đây có thể không cảm thấy ảnh hưởng của nanoe™. Những người có tóc quần gợn sóng, tóc quần tít, tóc rất mượt, tóc ngắn, hoặc những người ép thẳng tóc trong ba hoặc bốn tháng gần đây nhất.
- Không sử dụng bình xịt gần máy sấy khi máy đang hoạt động.  
Các hạt nước của bình xịt có thể bị hút vào máy sấy, làm giảm hiệu suất hoạt động.

## Giới thiệu về nanoe™

### nanoe™ là gì?

(phương pháp tạo nanoe™: Phóng điện cao áp)  
nanoe™ là các hạt nước mịn được tích điện, được tạo ra bằng điện áp cao để tách nước. Đường kính của nó nhỏ hơn 1/100 của hơi nước, và không thể nhìn thấy bằng mắt thường. Do nanoe™ được tạo ra bằng cách lấy lượng nước có trong không khí, trong một số trường hợp nhất định tùy vào môi trường có thể sẽ gặp khó khăn khi tạo ra chúng. (Sẽ khó khăn hơn để lấy lượng nước có trong không khí khi trời đang lạnh và độ ẩm thấp.)

### Cách thức nanoe™ hoạt động

Thông thường, tóc người có đặc tính dễ dàng tích điện dương. Những đặc tính này sẽ giúp tóc hấp thu mạnh mẽ nanoe™ điện tích âm mang theo độ ẩm để thẩm thấu qua tóc. Hơn nữa, chúng sẽ làm cho tóc có tính axit nhẹ, giúp làm săn chắc lớp biểu bì tóc và giữ tóc luôn chắc, đàn hồi và khỏe mạnh.

## Giới thiệu về ion platinum

### Ion platinum là gì?

Phương pháp Tạo Ion Platinum: Phóng điện cao áp

Ion là các hạt kết hợp oxy mang điện tích âm và độ ẩm trong không khí. Ion Platinum là các ion được tạo ra từ điện cực bằng bạch kim. Những ion này không nhìn thấy được bằng mắt thường vì đường kính của chúng chỉ bằng 1/1000 hạt hơi nước.

### Các ion platinum có tác dụng như thế nào

Thông thường, tóc có thể dễ dàng tích điện dương. Bằng cách để tóc tiếp xúc với các ion platinum mang điện tích âm, tính điện của tóc có thể được trung hòa và do đó giúp mái tóc được mượt mà.

Các ion platinum không chỉ thâm nhập vào từng sợi tóc, mà còn vào cả vỏ sợi tóc, do đó giúp duy trì độ ẩm và làm giảm bớt hư hỏng do tia tử ngoại UV.

#### ► Lưu ý

Không quan sát được nhiều ảnh hưởng của ion ở những người có các đặc điểm được mô tả dưới đây.

- Có cấu trúc tóc ban đầu dạng xoắn.
- Có tóc dễ bị gãy nếp.
- Có mái tóc tuyệt vời và gọn gàng.
- Có tóc duỗi thẳng thẳng không quá 3 – 4 tháng.
- Có tóc ngắn.

## Bảng nạp nanoe™

Khi các ion nanoe™/platinum tiếp tục tiếp xúc với tóc, tóc sẽ trở nên tích điện âm. Do đó, các ion nanoe™/platinum và tóc tích điện âm sẽ đẩy nhau, gây khó khăn cho các ion nanoe™/platinum tiếp xúc được với tóc.

Với Hệ thống Nạp nanoe™, chỉ cần kẹp bằng điều khiển với tay cầm, điện tích âm tích tụ trên tóc sẽ giảm.

Nhờ đó, các ion nanoe™/platinum tiếp tục thâm nhập vào tóc, cung cấp độ ẩm và làm ẩm đến tận ngọn tóc.

## Bảo trì máy sấy tóc

- Đảm bảo đã TẮT công tắc chính và ngắt phích cắm ra khỏi ổ cắm điện nhà. (Ngoại trừ khi thực hiện việc bảo trì cho miệng thổi gió)

## Bảo trì máy sấy tóc

Chỉ được vệ sinh phần vỏ máy bằng một miếng vải mềm hơi ẩm với nước máy hoặc nước máy pha xà phòng.

### ► Ghi chú

- Không được dùng các chất dung môi, ét-xăng, cồn hoặc các hóa chất khác.
  - Làm như vậy có thể gây ra sự cố, nứt/phai màu các bộ phận v.v...
- Nếu để máy sấy tóc bị các sản phẩm dùng cho tóc hoặc trang điểm dính vào tay cầm hoặc thân máy thì có thể làm xuống cấp phần nhựa, gây phai màu hoặc nứt nẻ và làm máy hư hỏng.

## Bảo trì đầu phun nanoe™

- Sử dụng các que bông có bán trên thị trường. (Chúng tôi khuyến cáo nên dùng loại que bông dành cho trẻ em.)
- Việc bảo trì này cho phép máy sấy tóc duy trì được mức nhà nanoe™ trong một thời gian dài.

1. Thấm ướt đầu que bông bằng nước máy.
2. Phần mũi kim nằm sâu bên trong đầu phun nanoe™. Dùng que bông chà nhẹ phần này khoảng 5 lần.

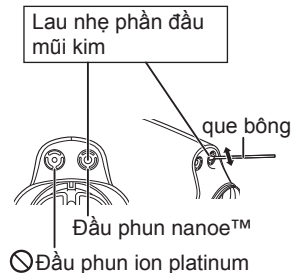

Không được cố làm sạch đầu phun ion platinum (⊘). (Đầu phun này có cấu trúc làm cho việc đưa que bông vào rất khó khăn.)

Làm như vậy có thể dẫn đến mất khả năng nhà ion platinum.

## Bảo trì cổng hút khí

Lau sạch các xơ vải, tóc hoặc các vật khác từ cổng hút khí bằng khăn lau.

- Không được bấm hoặc chà xát cổng hút khí bằng móng tay hoặc các vật sắc nhọn khác. Làm như vậy có thể làm hỏng cổng hút khí.

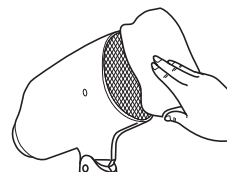

## Bảo trì miệng thổi gió

- Máy sấy tóc này nên được cắm vào ổ điện nhà chỉ trong trường hợp hợp bảo trì miệng thổi gió.
- Sử dụng một bàn chải đánh răng có trên thị trường.
- Bật bộ phận chọn tốc độ sang “Cool” (Không khí lạnh) và thổi bỏ bụi đi khi bạn chà nhẹ bằng bàn chải đánh răng.
- Trong quá trình bảo trì, không được chặn cổng hút khí bằng tay v.v...
- Chà nhẹ để loại bỏ mọi thứ bụi, tóc, v.v... đang chặn lưới.

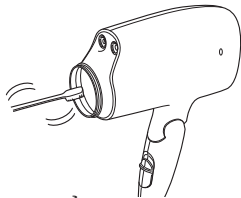

Phải cẩn thận khi sử dụng máy sấy tóc lần đầu sau khi mới bảo trì bởi máy có thể thổi ra bụi, v.v...

## Xử lý sự cố

Vấn đề	Nguyên nhân có thể	Hành động
Máy thường xuyên chuyển sang không khí mát khi sử dụng ở chế độ "Hot" (Không khí nóng), hoặc có thể nhìn thấy tia lửa bên trong thân máy. (Các tia lửa này gây ra bởi rò-le nhiệt, thiết bị bảo vệ và điều này không phải là lỗi thiết bị.)	Xơ sợi bị tích tụ trên cổng hút khí hoặc miệng thổi gió. Tóc hoặc thứ khác bít chặn cổng hút khí.	Gỡ bỏ xơ sợi bị tích tụ. Không được bít chặn cổng hút khí.
Không khí nóng bị nóng bất thường.		
Phích cắm bị nóng bất thường.	Kết nối vào ổ điện nhà bị lỏng.	Sử dụng ổ điện nhà gắn khít chặt.
Có tia lửa tạo ra trong đầu phun nanoe™.		
Đầu phun nanoe™ phát ra tiếng động (tiếng tanh tách).	Bất thường gây ra do điện cực bị bẩn (phần mũi kim).	Tiến hành bảo trì đầu phun nanoe™.

Nếu vẫn không giải quyết được vấn đề, hãy liên hệ với cửa hàng nơi bạn mua thiết bị đó hoặc một trung tâm dịch vụ được ủy quyền của Panasonic để sửa chữa.

## Các thông số kỹ thuật

Tên sản phẩm	Máy sấy tóc		
Mẫu sản phẩm	EH-NA45		
Nguồn điện	220 V ~ 50-60 Hz	230 V ~ 50-60 Hz	240 V ~ 50-60 Hz
Mức độ tiêu thụ điện	1350 W	1500 W	1600 W
Phụ kiện	Đầu sấy khô nhanh, Đầu chỉnh hẹp		

Sản phẩm này chỉ dành để sử dụng trong gia đình.

## Konten

---

<b>Tindakan pengamanan .....</b>	<b>54</b>	<b>Panel pengisi daya nanoe™ .....</b>	<b>60</b>
<b>Identifikasi bagian-bagian .....</b>	<b>58</b>	<b>Perawatan pengering rambut .....</b>	<b>60</b>
<b>Cara menggunakan pengering rambut... ..</b>	<b>58</b>	<b>Pemecahan masalah .....</b>	<b>62</b>
<b>Tentang nanoe™ .....</b>	<b>59</b>	<b>Spesifikasi .....</b>	<b>62</b>
<b>Tentang ion platinum .....</b>	<b>59</b>		

Terima kasih telah membeli produk Panasonic ini.

**Sebelum mengoperasikan alat ini, harap baca instruksi secara menyeluruh dan simpanlah untuk penggunaan di masa mendatang.**

nanoe™ merupakan merek dagang dari Panasonic Corporation.  
nanoe™ merupakan partikel ion seukuran nano yang dilapisi partikel air.

## Tindakan pengamanan

Untuk mengurangi risiko cedera, korban jiwa, kejutan listrik, kebakaran, malfungsi, dan kerusakan terhadap peralatan atau properti, selalu ikuti tindakan pencegahan berikut ini untuk keamanan.

## Penjelasan simbol

Simbol-simbol berikut ini digunakan untuk menggolongkan dan menggambarkan tingkat bahaya, cedera, dan kerusakan properti yang ditimbulkan ketika petunjuk diabaikan dan alat digunakan secara tidak benar.



## PERINGATAN

Menunjukkan potensi bahaya yang dapat berakibat pada cedera parah atau kematian.



## AWAS

Menunjukkan bahaya yang dapat berakibat pada cedera ringan.

Simbol berikut ini digunakan untuk menggolongkan dan menggambarkan jenis instruksi yang harus diikuti.



Simbol ini digunakan untuk memberi tahu pengguna mengenai prosedur pengoperasian tertentu yang tidak boleh dilakukan.



Simbol ini digunakan untuk memberi tahu pengguna mengenai prosedur pengoperasian tertentu yang harus diikuti untuk mengoperasikan alat ini secara aman.



## PERINGATAN

**Jangan simpan dalam jangkauan anak-anak atau balita.**

**Jangan biarkan mereka menggunakan alat ini.**



- Jika melakukannya, dapat menyebabkan luka bakar, kejutan listrik, atau cedera.

**Jangan pernah mengubah, membongkar, atau memperbaiki alat ini.**



- Jika melakukannya, dapat menyebabkan terpicunya api atau cedera akibat pengoperasian yang tidak normal.  
Hubungi pusat layanan resmi untuk perbaikan.

**Jangan merusak atau memodifikasi, atau secara paksa membengkokkan, menarik, atau memilin kabel.**



**Selain itu, jangan menaruh kabel di bawah benda berat atau menjepit kabel.**

- Tindakan tersebut dapat menyebabkan kejutan listrik atau kebakaran karena arus pendek.

**Jangan gunakan bila kabel dalam kondisi terliilit-liilit.**



- Tindakan tersebut dapat menyebabkan kebakaran atau kejutan listrik.



## PERINGATAN

**Jangan melilitkan kabel secara ketat di sekeliling bodi utama alat ketika menyimpannya.**

- Tindakan tersebut dapat menyebabkan kawat di dalam kabel patah disertai muatan listriknya, dan dapat menyebabkan kejutan listrik atau kebakaran karena arus pendek.

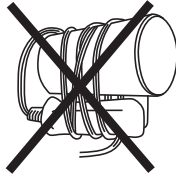

**Jangan gunakan bila steker daya atau kabel rusak atau panas.**

- Tindakan tersebut dapat menyebabkan luka bakar, kejutan listrik atau kebakaran karena arus pendek.

**Jangan pernah menggunakan alat ini jika steker daya longgar di stopkontak rumah.**

- Tindakan tersebut dapat menyebabkan luka bakar, kejutan listrik atau kebakaran karena arus pendek.

**Jangan memasang atau mencabut steker daya dari stopkontak rumah dengan tangan basah.**

- Tindakan tersebut dapat menyebabkan kejutan listrik atau cedera.

**Jangan gunakan alat dengan tangan basah.**

- Tindakan tersebut dapat menyebabkan kejutan listrik atau kebakaran karena arus pendek.



**Jangan tinggalkan area tersebut dalam kondisi sakelar utama menyala.**

- Hal tersebut dapat menyebabkan kebakaran.



**Jangan menyimpan alat ini di kamar mandi atau di lokasi dengan kelembapan tinggi. Selain itu, jangan ditaruh di lokasi di mana air bisa tumpah (seperti di atas meja rias).**

- Tindakan tersebut dapat menyebabkan kejutan listrik atau kebakaran.



**Jangan tutupi, atau masukkan jepit rambut atau benda asing lainnya ke dalam lubang udara masuk, lubang udara keluar, lubang keluar nanoe™, atau lubang keluar ion platinum.**

- Tindakan tersebut dapat menyebabkan kebakaran, kejutan listrik, atau luka bakar.



**Jangan gunakan di dekat bahan yang mudah terbakar (seperti alkohol, bensin, tiner, semprotan, produk perawatan rambut, penghapus cat kuku).**

- Tindakan tersebut dapat menyebabkan ledakan atau kebakaran.



**Jangan masukkan alat ini ke dalam air.**

**Jangan gunakan pengering rambut ini di dekat air.**

**Jangan gunakan pengering rambut ini di dekat bak mandi, shower, bak cuci, atau wadah lain yang berisi air.**

- Tindakan tersebut dapat menyebabkan kejutan listrik atau kebakaran.



Simbol pada pengering rambut ini berarti "Jangan gunakan pengering rambut ini di dekat air".



## PERINGATAN

**Segera hentikan penggunaan dan cabut steker daya bila terdapat ketidaknormalan atau kegagalan.**

- Jika tidak maka dapat menyebabkan kebakaran, kejutan listrik, atau cedera.



**<Kasus ketidaknormalan atau kegagalan>**

- Udara tidak dikeluarkan
- Alat berhenti secara sporadis
- Bagian dalam menjadi sangat panas dan keluar asap
- Segera upayakan pemeriksaan atau perbaikan di pusat layanan resmi.

**Gunakan hanya stopkontak rumah saja: jangan gunakan dengan kabel perpanjangan.**

- Jika tidak maka dapat menyebabkan kebakaran atau kejutan listrik.



**Colokkan steker daya secara sempurna.**

- Jika tidak maka dapat menyebabkan kebakaran atau kejutan listrik.

**Pastikan bahwa peralatan dioperasikan dengan sumber listrik yang sesuai dengan tegangan dasarnya yang ditunjukkan pada peralatan.**

- Jika tidak maka dapat menyebabkan kebakaran, kejutan listrik, atau luka bakar.

**Bila Anda melihat percikan api di sekitar lubang udara keluar saat menggunakan pengaturan udara panas, hentikan penggunaan dan singkirkan benang halus dari lubang udara keluar dan lubang udara masuk.**

- Jika tidak dapat menyebabkan luka bakar atau kebakaran.



**Selalu MATIKAN sakelar utama dan cabut steker daya dari stopkontak rumah setelah digunakan.**

- Jika tidak dapat menyebabkan kebakaran atau luka bakar.

**Cabut steker daya dengan cara memegangnya, bukan menarik kabel.**



- Jika tidak maka dapat menyebabkan kawat di dalam kabel patah, dan dapat menyebabkan luka bakar, kejutan listrik, atau kebakaran karena arus pendek.

**Secara rutin bersihkan steker daya agar debu tidak menumpuk.**



- Jika tidak maka dapat menyebabkan kebakaran karena kegagalan insulasi yang disebabkan oleh kelembapan. Cabut steker daya dan seka dengan kain kering.

**Ketika pengering rambut digunakan di kamar mandi, cabut setelah digunakan karena dapat menimbulkan bahaya ketika berada di dekat air meskipun pengering rambut dimatikan.**



- Jika tidak maka dapat menyebabkan kecelakaan atau cedera.

**Untuk perlindungan tambahan, disarankan pemasangan RCD (residual current device) yang memiliki arus pengoperasian residu terukur tidak melebihi 30 mA dalam rangkaian listrik untuk penggunaan di kamar mandi. Mintalah saran dari petugas yang memasang alat ini.**



- Jika tidak maka dapat menyebabkan kecelakaan atau cedera.

**Alat ini tidak untuk digunakan oleh orang (termasuk anak-anak) dengan kemampuan fisik, indera dan mental yang kurang, atau kurang pengetahuan dan pengalaman, kecuali yang sudah diberi pengarahan atau petunjuk tentang penggunaan alat ini oleh orang yang bertanggung jawab atas keselamatan mereka.**



**Anak-anak harus diawasi untuk memastikan agar mereka tidak bermain-main dengan alat ini.**

- Jika tidak maka dapat menyebabkan kecelakaan atau cedera.



## PERINGATAN



Apabila kabel daya rusak, maka harus diganti oleh pabrik, agen servis atau petugas yang berkualifikasi sama untuk menghindari bahaya.

- Jika tidak maka dapat menyebabkan kecelakaan atau cedera.



## AWAS



**Jangan menyimpan kabel dalam kondisi terpilin.**

- Tindakan tersebut dapat menyebabkan kawat di dalam kabel patah disertai muatan listriknya, dan dapat menyebabkan kejutan listrik atau kebakaran karena arus pendek.



**Jangan jatuhkan dan hindarkan dari benturan.**

- Tindakan tersebut dapat menyebabkan kejutan listrik atau terpicunya api.



**Jangan gunakan bila lubang udara masuk rusak.**

- Rambut Anda dapat terbelit di lubang udara masuk, dan dapat merusak rambut Anda.



**Jangan menyentuh lubang udara keluar, nosel kering cepat, dan setel nosel, yang akan menjadi sangat panas.**

- Hal tersebut dapat menyebabkan luka bakar.



**Jangan gunakan pada anak-anak atau balita.**

- Hal tersebut dapat menyebabkan luka bakar.

Ketika membuka atau melipat gagang, jangan menyentuh area yang diberi bayang-bayang seperti pada gambar di bawah ini.

- Hal tersebut dapat menyebabkan cedera pada jari.

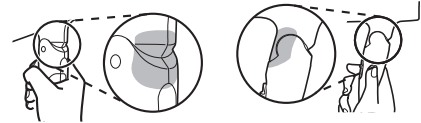

**Berhati-hatilah saat Anda mengarahkan pengering rambut, dan pastikan untuk menjaga jarak dari rambut sekurangnya 10 cm dari lubang udara masuk.**

- Rambut Anda dapat terbelit di lubang udara masuk, dan dapat merusak rambut Anda.



**Jaga jarak lebih dari 3 cm antara lubang udara keluar dan rambut Anda.**

- Jika tidak maka dapat menyebabkan rambut Anda terbakar.



**Gunakan hanya untuk mengeringkan atau menata rambut manusia. (Jangan gunakan pada binatang piaraan, atau untuk mengeringkan pakaian, sepatu, dll.)**

- Jika tidak dapat menyebabkan kebakaran atau luka bakar.

### ► Catatan

- Pengering rambut ini dilengkapi dengan perangkat perlindungan panas-berlebih otomatis. Apabila pengering rambut terlalu panas, alat ini akan beralih ke mode udara dingin. Matikan pengering rambut dan cabut dari stopkontak rumah. Dinginkan selama beberapa menit sebelum menggunakannya kembali. Periksa agar benda halus, rambut, dll. tidak ada di dalam lubang udara masuk dan lubang udara keluar sebelum menyalakannya kembali.
- Anda mungkin akan mencium bau khas ketika menggunakan pengering rambut ini. Hal ini disebabkan oleh ozon yang dibentuknya dan ini tidak berbahaya bagi tubuh manusia.

## Identifikasi bagian-bagian

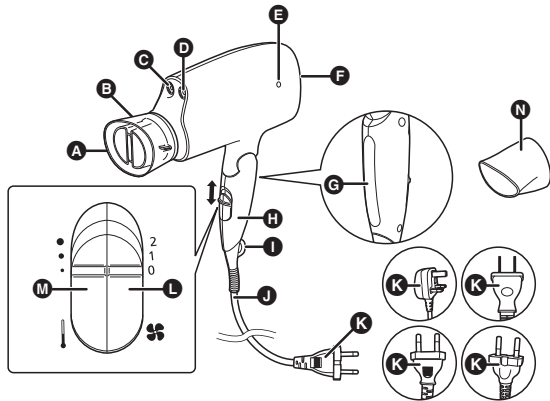

- A** Lubang udara keluar
- B** Nosel kering cepat
- C** Lubang keluar ion platinum
- D** Lubang keluar nanoe™
- E** Lampu nanoe™
- F** Lubang udara masuk
- G** Panel pengisi daya nanoe™
- H** Gagang
- I** Cincin untuk menggantung
- J** Kabel
- K** Steker daya  
(Bentuk steker daya berbeda-beda tergantung dari areanya.)
- L** Sakelar utama (☸)  
2: Kering (Aliran udara kuat)  
1: Set (Aliran udara pelan)  
0: OFF
- M** Pemilih suhu ( ↓ )  
● : Panas (Udara panas)  
● : Sehat (Udara hangat)  
● : Dingin (Udara dingin)
- N** Setel nosel

### ► Nosel kering cepat

Untuk mengeringkan rambut secara cepat

Pasang nosel kering cepat sehingga lubang udara keluar berdiri vertikal.

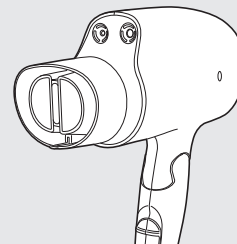

### ► Setel nosel

Untuk penataan yang tepat

## Cara menggunakan pengering rambut

**1** Pilih suhu aliran udara dengan pemilih suhu (M).

**2** Pilih intensitas aliran udara dengan sakelar utama (L).

### ► Catatan

- Jika Anda menggunakan udara dingin untuk mengeringkan rambut, setel sakelar utama (L) ke posisi "1" atau "2" dan setel pemilih suhu ke "● : Dingin (Udara dingin)".
- nanoe™ dan ion platinum dihasilkan jika sakelar utama (L) disetel ke posisi "1" atau "2".
- nanoe™ dan ion platinum tidak tampak oleh mata telanjang.
- Gunakan setel nosel (N) untuk memusatkan aliran udara.
- Apabila Anda khawatir dengan kerusakan rambut, setel sakelar ke "1: Set (Aliran udara pelan)" sebelum menggunakannya.

- Tetesan air dapat keluar dari lubang keluar nanoe™ (D) selama penggunaan, tetapi ini bukan kerusakan.
- Bunyi dengungan dapat keluar dari lubang keluar nanoe™ (D), tetapi ini adalah bunyi nanoe™ yang sedang dilepas muatannya dan bukan merupakan kerusakan.
- Pengaruh nanoe™ mungkin tidak dapat dirasakan oleh orang-orang berikut ini. Orang dengan rambut berombak, rambut sangat keriting, rambut sangat halus, rambut pendek, atau orang yang rambutnya diluruskan dalam tiga atau empat bulan terakhir.
- Jangan gunakan semprotan di dekat pengering saat dioperasikan. Isi semprotan bisa tersedot ke dalam pengering, mengakibatkan kinerjanya menurun.

## Tentang nanoe™

### Apakah nanoe™ itu?

(metode dalam menghasilkan nanoe™: pelepasan voltase tinggi) nanoe™ merupakan partikel air halus bermuatan yang dihasilkan dengan menggunakan voltase tinggi guna membelah air. Diameternya lebih kecil dari uap 1/100, dan tidak dapat terlihat dengan mata telanjang. Karena nanoe™ dihasilkan dengan cara mengumpulkan air di udara, maka mungkin akan sulit untuk menghasilkannya dalam kasus tertentu karena tergantung pada lingkungannya. (Akan lebih sulit lagi mengumpulkan air di udara ketika cuaca dingin dan kelembapan rendah.)

### Bagaimana cara kerja nanoe™

Pada umumnya rambut memiliki sifat-sifat yang membuatnya mudah diberi muatan arus listrik positif. Sifat-sifat ini akan menarik nanoe™ bermuatan sangat negatif yang menembus rambut dengan kelembapan. Selanjutnya, rambut akan dibuatnya sedikit asam, kutikula dikencangkan dan rambut Anda dijaga agar tetap kuat, elastis dan sehat.

## Tentang ion platinum

### Apakah ion platinum itu?

Metode Menghasilkan Ion Platinum: Pelepasan voltase tinggi

Ion merupakan partikel yang menggabungkan oksigen bermuatan negatif dan uap air di udara. Ion platinum merupakan ion yang dihasilkan dari elektrode platinum. Ion-ion ini tidak tampak oleh mata telanjang karena diameternya hanya 1/1000 dari partikel uap.

### Bagaimana cara kerja ion platinum

Secara umum, rambut mudah saja mendapat muatan listrik positif. Dengan memaparkan rambut ke ion platinum bermuatan listrik negatif, listrik statis pada rambut dapat dinetralkan dan menambah kelembutannya.

Ion platinum tidak hanya menembus setiap helai rambut, tapi juga melapisi rambut, dan membantu mempertahankan kadar uap serta mengurangi kerusakan karena UV.

#### ► Catatan

Efek ion tidak terlalu nampak pada orang dengan ciri-ciri yang digambarkan di bawah ini.

- Memiliki rambut yang aslinya ikal.
- Memiliki rambut yang mudah tergulung.
- Memiliki rambut yang bagus dan rapi.
- Memiliki rambut yang pernah diluruskan dalam waktu 3 – 4 bulan.
- Rambut pendek.

## Panel pengisi daya nanoe™

Jika nanoe™/ion platinum terus mengenai rambut, maka rambut akan menjadi bermuatan negatif. Akibatnya, nanoe™/ion platinum dan rambut yang bermuatan negatif akan saling tolak-menolak, sehingga membuat nanoe™/ion platinum sulit untuk mengenai rambut.

Dengan Sistem Pengisi Daya nanoe™, dengan hanya menjepit panel berikut gagang-nya, muatan negatif yang terkumpul di rambut akan dilepaskan.

Karenanya, nanoe™/ion platinum akan terus menembus ke dalam rambut, memberikan kelembapan dan akan melembapkan secara menyeluruh hingga ke ujung rambut.

## Perawatan pengering rambut

- Pastikan untuk **MEMATIKAN** sakelar utama dan mencabut steker daya dari stopkontak rumah. (Kecuali ketika melakukan perawatan pada lubang udara keluar)

## Merawat pengering rambut

Bersihkan rumahnya saja dengan kain lembut yang sedikit dibasahi dengan air keran atau air keran bersabun.

### ► Catatan

- Jangan gunakan tiner, bensin, alkohol atau bahan kimia lainnya.
  - Jika tetap digunakan maka dapat menyebabkan kerusakan fungsi, keretakan/perubahan warna pada komponen alat, dll.
- Membiarkan produk perawatan rambut atau riasan masih melekat pada gagang atau bodi pengering rambut dapat menurunkan kualitas plastik, yang menyebabkan warna berubah atau retak, dan kerusakan fungsi.

## Merawat lubang keluar nanoe™

- Gunakan kapas korek telinga biasa. (Kami anjurkan kapas korek telinga tipis buat bayi.)
- Dengan perawatan ini, pengering rambut dapat mempertahankan tingkat nanoe™ yang dihasilkan dalam waktu yang lama.

1. Basahi ujung kapas korek telinga dengan air keran.
2. Bagian jarum berada di bagian dalam lubang keluar nanoe™. Saat menggunakan kapas korek telinga, gosok bagian ini dengan perlahan sekitar 5 kali.

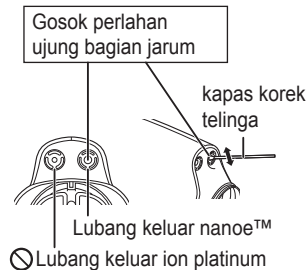

Jangan mencoba membersihkan lubang keluar ion platinum (Ⓞ). (Lubang tersebut memiliki struktur yang menyulitkan untuk memasukkan kain penyeka.) Hal tersebut berakibat pada hilangnya kemampuan untuk melepaskan ion platinum.

## Merawat lubang udara masuk

Seka untuk membersihkan benang halus, rambut, atau benda lain dari lubang udara masuk dengan tisu.

- Jangan menekan atau menggosok lubang udara masuk dengan kuku atau benda tajam lainnya. Hal tersebut dapat merusak lubang udara masuk.

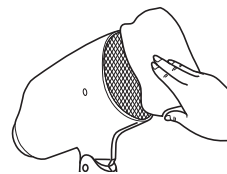

## Merawat lubang udara keluar

- Peningering rambut harus dicolokkan hanya ke stopkontak rumah saja dalam saat merawat lubang udara keluar.
- Gunakan sikat gigi biasa.
- Putar pemilih suhu ke “Dingin” dan Hembuskan keluar debu, dll. sambil membersihkannya dengan sikat gigi.
- Selama perawatan, jangan menghalangi lubang udara masuk dengan tangan, dll.
- Berhati-hatilah saat menggunakan pengering rambut untuk pertama kalinya setelah perawatan, karena alat mungkin akan mengembuskan debu keluar, dll.

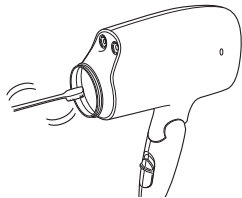

Sikatlah untuk menyingkirkan debu, rambut dll. yang menghalangi penyaring.

## Pemecahan masalah

Masalah	Kemungkinan penyebab	Tindakan
Alat ini akan sering berganti ke udara dingin saat digunakan dalam mode "Panas", atau percikan api dapat terlihat di dalam bodi alat. (Percikan ini disebabkan oleh sakelar termostatik, perangkat perlindungan, dan ini bukanlah kerusakan.)	▶ Benang halus telah menumpuk pada lubang udara masuk atau lubang udara keluar.	▶ Singkirkan tumpukan benang halus.
Udara panas menjadi panas secara tidak normal.	▶ Rambut atau sesuatu menyumbat lubang udara masuk.	▶ Jangan tutupi lubang udara masuk.
Steker daya menjadi panas secara tidak normal.	▶ Sambungan ke stopkontak rumah longgar.	▶ Gunakan stopkontak rumah yang cocok secara aman.
Keluar percikan api dari dalam lubang keluar nanoe™.	▶ Abnormalitas disebabkan oleh elektroda kotor (bagian jarum).	▶ Lakukan perawatan pada lubang keluar nanoe™.
Lubang keluar nanoe™ mengeluarkan bunyi (bunyi keritik).		

Jika masalah masih belum teratasi, hubungi toko tempat Anda membeli alat tersebut atau pusat servis resmi Panasonic untuk perbaikan.

## Spesifikasi

Nama produk	Pengering Rambut		
Model produk	EH-NA45		
Sumber listrik	220 V ~ 50-60 Hz	230 V ~ 50-60 Hz	240 V ~ 50-60 Hz
Konsumsi listrik	1350 W	1500 W	1600 W
Aksesoris	Nosel kering cepat, setel nosel		

Produk ini dimaksudkan untuk penggunaan rumah tangga saja.

### Diimpor oleh:

**PT. Panasonic Gobel Indonesia**

Jl. Dewi Sartika No.14 (Cawang II).

Jakarta 13630 Indonesia

Telp. (021) 8090108, Fax. (021) 8004368

Made in Thailand / Produksi Thailand



Panasonic Corporation  
<http://panasonic.net/>  
© Panasonic Corporation 2013