

Panasonic®

Model No.:
TH-55HX750K
TH-65HX750K

Operating Instructions

LED TV

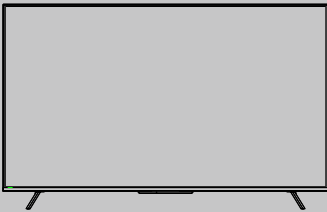

For the purpose of recycling to facilitate effective utilization of Resources, please return this product to a nearby authorized collection center, registered dismantler or recycler, or Panasonic service center when disposing of this product.

Thank you for purchasing this Panasonic product.
Please read these instructions carefully before operating this product and retain them for future reference.

The images shown in this manual are for illustrative purposes only.

English

androidtv

Google, Android TV, Google Play, Chromecast built-in, YouTube and other related marks and logos are trademarks of Google LLC.



The Adopted Trademarks HDMI, HDMI High-Definition Multimedia Interface, and the HDMI Logo are trademarks or registered trademarks of HDMI Licensing Administrator, Inc. in the United States and other countries.



For DTS patents, see <http://patents.dts.com>.
Manufactured under license from DTS Licensing Limited, DTS, the Symbol, DTS and the Symbol together, and DTS Studio Sound are registered trademarks or trademarks of DTS, Inc. in the United States and/or other countries.
© DTS, Inc. All Rights Reserved.



Dolby, Dolby Vision, Dolby Atmos, and the double-D symbol are registered trademarks of Dolby Laboratories Licensing Corporation. Manufactured under license from Dolby Laboratories. Confidential unpublished works. Copyright © 2012-2020 Dolby Laboratories. All rights reserved.

Table of Contents

Chapter 1: Introduction

Warning	3
Use Environment	4
Cleaning	4
Hanging the TV Set on the Wall	4
Caution	4
Symbol	6
Precautions for Using Remote Control	6
Installing/Removing Remote's Batteries	6
Standard Accessories	7
Optional Accessories	7
Pedestal Installation.....	8

Chapter 2: Basic Features

TV Terminals	9
TV Controls	10
Remote Control.....	11
Voice Function.....	12
How to Pair Bluetooth Remote Control with the TV	13
Initial Setup	14
Selecting the Input Source	17
Electronic Program Guide.....	18
Time Shift Function	18
Quick Menu Settings	18
Main Menu Settings	18

Chapter 3: Smart Features

Home Page.....	22
Google Assistant.....	22
Google Play.....	23
Chromecast Built-In.....	23
Disclaimer about Using Android	25
Multimedia Player	25

Chapter 4: Technical Information

Maintenance	27
Troubleshooting	27
Specifications	28
Built-in wireless LAN and Bluetooth specification	29

Chapter 1: Introduction

⚠ Warning

Handling the mains plug and lead

Insert the mains plug fully into the socket outlet. (If the mains plug is loose, it could generate heat and cause fire.)

Ensure that the mains plug is easily accessible.

Do not touch the mains plug with a wet hand. (This may cause electrical shock.)

Do not use any mains lead other than that provided with this TV. (This may cause fire or electrical shock.)

Do not damage the mains lead. (A damaged lead may cause fire or electrical shock.)

- Do not move the TV with the lead plugged in the socket outlet.
- Do not place a heavy object on the lead or place the lead near a high-temperature object.
- Do not twist the lead, bend it excessively or stretch it.
- Do not pull on the lead. Hold onto the mains plug body when disconnecting the lead.
- Do not use a damaged mains plug or socket outlet.
- Use the TV in moderate climates.

If you find any abnormality, remove the mains plug immediately!



100 - 240V ~ 50 / 60 Hz

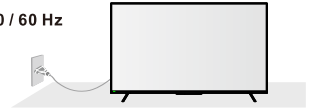

- Mains plug types vary between countries.

Power source

- This TV is designed to operate on
- 100 - 240V ~ 50/60 Hz
- Table-top use / Wall hanging

Do not insert external objects into the TV

- Do not allow any objects to drop into the TV through the air vents. (Fire or electrical shock may result)

Do not use external voltage stabilizer with the TV set

- Inferior quality stabilizer may cause damage to the TV.
- Warranty is not valid if external stabilizer is used.

Do not place the TV on sloped or unstable surfaces, and ensure that the TV does not hang over the edge of the base

- The TV may fall off or tip over.

Do not remove covers and never modify the TV by yourself

- Do not remove the rear cover as live parts are accessible when it is removed. There are no user serviceable parts inside. (High-voltage components may cause serious electrical shock.)
- Have the TV checked, adjusted, or repaired at your local Panasonic dealer.
- Please refer the information on exterior back enclosure for electrical and safety information before installing or operating the apparatus.
- The mains plug is used as disconnect device, the disconnect device shall remain readily operable.

Use only the dedicated pedestals/ mounting equipments

- Use an unapproved pedestal or other fixtures may make the TV unstable, risking injury. Be sure to ask your local Panasonic dealer to perform setup.
- When mounting the TV on a wall or ceiling, be sure to install the product according to the method recommended by the manufacturer. This is a safety feature.
- Only use attachments/accessories specified or provided by the manufacturer (such as the exclusive supply adapter, battery, etc.).

Do not expose to rain or excessive moisture

- To prevent damage which might result in electrical shock or fire, do not expose this TV to rain or excessive moisture. This TV must not be exposed dripping or splashing water and objects filled with liquid, such as vases, must not be placed on top of or above the TV.

Do not expose to direct sunlight and other sources of heat

- Avoid exposing the TV to direct sunlight and other sources of heat.



To prevent the spread of fire, keep candles or other open flames away from this product at all times.

Use Environment

⚠ Warning: Stability Hazard

A television set may fall, causing serious personal injury or death. Many injuries, particularly to children, can be avoided by taking simple precautions such as:

- ALWAYS use cabinets or stands or mounting methods recommended by the manufacturer of the television set.
- ALWAYS use furniture that can safely support the television set.
- ALWAYS ensure the television set is not overhanging the edge of the supporting furniture.
- ALWAYS educate children about the dangers of climbing on furniture to reach the television set or its controls.
- ALWAYS route cords and cables connected to your television so they cannot be tripped over, pulled or grabbed.
- NEVER place a television set in an unstable location.
- NEVER place the television set on tall furniture (for example, cupboards or bookcases) without anchoring both the furniture and the television set to a suitable support.
- NEVER place the television set on cloth or other materials that may be located between the television set and supporting furniture.
- NEVER place items that might tempt children to climb, such as toys and remote controls, on the top of the television or furniture on which the television is placed.

If the existing television set is being retained and relocated, the same considerations as above should be applied.

Cleaning

- Do not spray water or detergent directly on TV screen for cleaning purpose. Leaking liquid substance will cause damage to TV.
- Be careful of cats, rats or other animals that may urinate on the TV (front and rear). It may lead to TV failure.
- Do not use sharp or hard objects (finger nails, knife and etc.) on TV screen. This may cause damage to the screen surface.

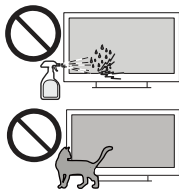

Hanging the TV Set on the Wall

- Check that the wall can support the weight of the TV set and wall mount assembly.
- Follow the mounting instructions provided with the wall mount.
- The TV set must be installed on a vertical wall.
- Make sure to use only screws suitable for the material of the wall.
- Make sure that the TV set cables are placed so that there is not danger of tripping over them.

All other safety instructions about our TV sets are also applicable here.

Warning: This operation requires two people.

To ensure a safe installation, observe the following safety.

⚠ Caution

1. Read these instructions---All operating instructions must be read and understood before the product is operated.

2. Keep these instructions---These safety and operating instructions must be kept in a safe place for future reference.

3. Read all warnings---All warnings on the product and in the instructions must be observed closely.

4. Follow all instructions---All operating instructions must be followed.

5. Attachments---Only use attachments/ accessories specified by the manufacturer. Do not use attachments not recommended by the manufacturer. Use of improper attachments can result in accidents.

6. Power source---This product is intended to be supplied by a listed power supply indicated on the marking label. If you are not sure of the type of power supply to your home, consult your product dealer or local power company. For added protection for this product during a lightning storm, or when it is left unattended and unused for long periods of time, unplug it from the wall outlet and disconnect the cable system.

Do not defeat the safety purpose of the polarized or grounding plug. A polarized plug has two blades with one wider than the other. A grounding plug has two blades and a third grounding prong. The wide blade or the third prong is provided for your safety. If the provided plug does not fit into your outlet, consult an electrician for replacement of the obsolete outlet.

7. Power cord protection---Protect the power cord from being walked on or pinched particularly at plugs, convenience receptacles, and the point where they exit from the apparatus.

8. Overloading---Do not overload wall outlets, extension cords, or convenience receptacles on other equipment as this can result in a risk of fire or electric shock.

9. Servicing---Refer all servicing to qualified service personnel. Servicing is required when the apparatus has been damaged in any way, such as power-supply cord or plug is damaged, liquid has been spilled or objects have fallen into the apparatus, the apparatus has been exposed to rain or moisture, does not operate normally, or has been dropped.

10. Damage requiring service---If any of the following conditions occurs, unplug the power cord from the AC outlet, and request a qualified service person to perform repairs.

- a. When the power cord or plug is damaged.
- b. When a liquid is spilled on the product or when objects have fallen into the product.

- c. When the product has been exposed to rain or water.
- d. When the product does not operate properly as described in the operating instructions.

Do not touch the controls other than those described in the operating instructions. Improper adjustment of controls not described in the instructions can cause damage, which often requires extensive adjustment work by a qualified technician.

- e. If the product has been dropped or the cabinet has been damaged in any way.
- f. When the product displays an abnormal condition or exhibits a distinct change in performance. Any noticeable abnormality in the product indicates that the product needs servicing.

11. Replacement parts---In case the product needs replacement parts, make sure that the service person uses replacement parts specified by the manufacturer, or those with the same characteristics and performance as the original parts. Use of unauthorized parts can result in fire, electric shock and/or other danger.

12. Safety checks---Upon completion of service or repair work, request the service technician to perform safety checks to ensure that the product is in proper operating condition.

13. Stand---Use only with the cart, stand, tripod, bracket, or table specified by the manufacturer, or sold with the apparatus. Do not place the product on an unstable trolley, stand, tripod or table. Placing the product on an unstable base can cause the product to fall, resulting in serious personal injuries as well as damage to the product. When mounting the product on a wall, be sure to follow the manufacturer's instructions. Use only the mounting hardware recommended by the manufacturer.



14. Careful move---When a cart is used, use caution when moving the cart/apparatus combination to avoid injury from tip-over. Sudden stops, excessive force and uneven floor surfaces can cause the product to fall from the trolley. Never attempt to move the TV unless the AC power cord has been disconnected.

15. Lightning---Unplug this apparatus during lightning storms or when unused for long periods of time. For added protection for this television equipment during a lightning storm, or when it is left unattended and unused for long periods of time, unplug it from the wall outlet and disconnect the antenna. This will prevent damage to the equipment due to lightning and power-line surges.

16. Panel protection---The display panel used in this product is made of glass. Therefore, it can break when the product is dropped or impacted upon by other objects. Be careful not to be injured by broken glass pieces in case the display panel breaks.

17. Pixel defect---The display panel is a very high technology product, giving you finely detailed pictures. Occasionally, a few non-active pixels may appear on the screen as a fixed point of blue, green or red. Please note that this does not affect the performance of your product.

18. Do not block the rear air vents

- Adequate ventilation is essential to prevent failure of electronic components.
- Ventilation should not be impeded by covering the ventilation openings with items such as newspapers, table cloths and curtains.
- We recommended that a gap of at least 10 cm is left all around this TV even when placed inside a cabinet or between shelves.
- When using the pedestal, keep the space between the bottom of the TV and the surface where the TV is set.
- If pedestal is not used, ensure the vents is the bottom of the TV are not blocked.
- Do not install this equipment in a confined or building-in space such as a book case or similar unit, and remain a well ventilation conditions at open site.

Minimum distance

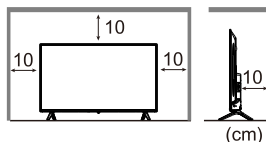





Note: The picture is only for reference.

19. Do not ingest the battery, Chemical Burn Hazard---Keep new and used batteries away from children. If the battery compartment does not close securely, stop using the product and keep it away from children. If you think batteries might have been swallowed or placed inside any part of the body, seek immediate medical attention.

- 20. Listening**— Listening to music at high volume levels and for extended durations can damage one’s hearing. In order to reduce the risk of damage to hearing, one should lower the volume to a safe, comfortable level, and reduce the amount of time listening at high levels.

Symbol

- For the terminals marked with symbol of “ ⚡ ” may be of sufficient magnitude to constitute a risk of electric shock. The external wiring connected to the terminals requires installation by an instructed person or the used of ready-made leads or cords.
- If the product has the symbol  in its rating label and the power cord has two pins, it means that the equipment is a Class II or double insulated electrical appliance. It has been designed in such a way that it does not require a safety connection to electrical earth.
- The following information are recommended to be included where applicable:
 - ~ Refers to alternating current(AC).
 - Refers to direct current(DC).
 -  Refers to Class II equipment.
 -  Refers to stand-by.
 - | Refers to power ON.
 -  Refers to dangerous voltage.



- This lightning flash with arrowhead symbol within an equilateral triangle is intended to alert the user to the presence of non-insulated “dangerous voltage” within the product’s enclosure that may be of sufficient magnitude to constitute a risk of electric shock.
- To reduce the risk of electric shock. Do not remove cover (or back). No user serviceable parts inside. Refer to qualified service personnel.
- The exclamation point within an equilateral triangle is intended to alert the user to the presence of important operating and maintenance instructions in the literature accompanying the appliance.

Precautions for Using Remote Control

- Use the remote control by pointing it towards the remote sensor. The items between the remote control and the remote sensor will interfere the normal operation.
- Do not make remote control vibrate violently. Also, do not splash liquid on the remote control, also do not put the remote control in high humidity place.
- Do not place remote control under direct sunlight which will cause deformation of the unit by heat.
- When the remote sensor is under direct sunlight or strong lighting, the remote control will do not work. If so please change the lighting or TV’s position, or operate the remote control closer to the remote sensor.

Installing/Removing Remote’s Batteries

Place two AAA size batteries in the remote control’s battery compartment, making sure to match the polarity markings inside the compartment.

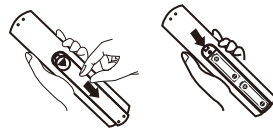

Note: The picture is only for reference.

Caution

- Incorrect installation may cause battery leakage and corrosion, resulting in damage to the remote control.
- Do not mix old and new batteries.
- Replace only with same or equivalent type. Do not mix different battery types (such as alkaline and manganese batteries) .
- Do not use rechargeable (Ni-Cd) batteries.
- Do not burn or break up batteries.
- Do not expose batteries to excessive heat such as sunshine, fire or the like.
- Make sure you dispose of batteries correctly.
- Ensure batteries are replaced correctly with the same or equivalent type, there is danger of explosion and fire if battery is reversed or incorrectly replaced.
- Do not disassemble or modify the remote control.

Standard Accessories

Remote Control



Pedestal (2)



Screws (4)



Batteries (2) (AAA size)



Operating Instructions



AC Power Cord

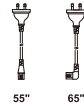

AV Converting Cable

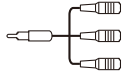

Note:

- 1) The pictures are only for reference.
- 2) Accessories may not be placed all together. Take care not to throw them away unintentionally.
- 3) This product contains possibly dangerous parts (such as plastic bags), that can be breathed in or swallowed by young children accidentally. Keep these parts out of reach of young children.

Optional Accessories

Please contact your local Panasonic dealer to purchase the recommended optional accessories. For additional details, please read the manual of optional accessories.

Wall-hanging bracket

Please contact your local Panasonic dealer to purchase the recommended wall-hanging bracket.

Note: The graphics are only for reference.

• Screw Specifications

Screw Spec.	55"		65"	
	Top	Down	Top	Down
E "Diameter" (mm)	M6	M6	M6	M6
D "Depth" (mm)	Max.	26	30	30
	Min.	22	20	20
Quantity	2	2	2	2

• VESA

Size	55"	65"
a (mm)	200	400
b (mm)	200	200

Warning

- Failure to use a Panasonic bracket or choosing to mount the unit yourself will be done at the risk of the consumer. Always be sure to ask a qualified technician to carry out set up. Incorrect fitting may cause equipment to fall, resulting in injury and product damage. Any damage resulting from not having a professional installer mount your unit will void your warranty.
- When any optional accessories or wall hanging brackets are used, always ensure that the instructions provided are followed fully.
- Do not mount the unit directly below ceiling lights (such as spotlights or halogen lights) which typically give off high heat. Doing so may warp or damage plastic cabinet parts.
- Take care when fixing wall brackets to the wall. Wall mounted equipment shall not be grounded by metal within the wall. Always ensure that there are no electrical cables or pipes in the wall before hanging bracket.
- To prevent fall and injury, remove the TV from its fixed wall position when it is no longer in use.
- For the TV sets with terminals facing towards the wall, in order to connect external devices, a 30mm-high plastic spacer is used together with each screw to fix the wall mount.

Pedestal Installation

Warning

Do not disassemble or modify the pedestal.

- Otherwise the TV may fall over and become damaged, and personal injury may result.

Caution

Do not use any pedestal other than the one provided with this TV.

- Otherwise the TV may fall over and become damaged, and personal injury may result.

Do not use the pedestal if it becomes warped or physically damaged.

- If you use the pedestal while it is physically damaged, personal injury may result. Contact your local Panasonic dealer immediately.

During set-up, make sure that all screws are securely tightened.

- If insufficient care is taken to ensure screws are properly tightened during assembly, the pedestal will not be strong enough to support the TV, and it might fall over and become damaged, and personal injury may result.

Ensure that the TV does not fall over.

- If the TV is knocked or children climb onto the pedestal with the TV installed, the TV may fall over and personal injury may result.

Two or more people are required to install and remove the TV.

- If two or more people are not present, the TV may be dropped, and personal injury may result.

When removing the pedestal from the TV, do not remove the pedestal by the methods other than the specified procedure.

- Otherwise the TV and / or pedestal may fall over and become damaged, and personal injury may result.

Appearance of the product in illustrations may differ from your actual product, and is for reference purposes only.

Removing the pedestal from the TV

Be sure to remove the pedestal in the following way when using the wall-hanging bracket or repacking the TV.

- 1 Remove the assembly screws from the TV.
- 2 Remove the pedestal from the TV.

Note: The pictures are only for reference.

1. Please take out the accessory bag from the package and check if all bellow parts exist without missing, if not, please contact your local dealer.

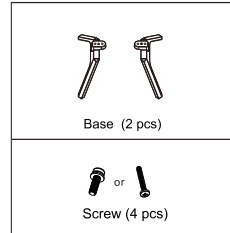

2. Take out the TV and carefully put it (screen downward) on a stable and flat table with a soft cloth or cushion on it.

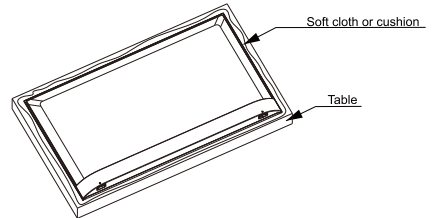

3. Connect the TV and base by putting and fastening matched screws into the holes.

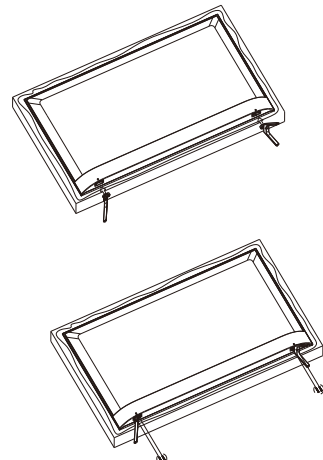

Chapter 2: Basic Features

TV Terminals

Note:

- 1) The pictures are only for reference.
- 2) The positions of terminals may vary by different models.

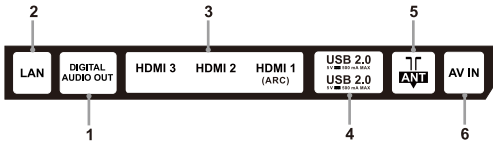
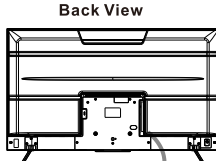

1. DIGITAL AUDIO OUT

connect an optical cable to output the TV's digital audio signal to a compatible audio receiver.

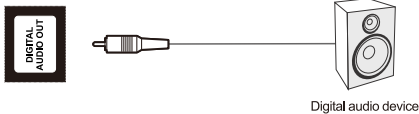

2. LAN

Wired network port.



3. HDMI IN

Receive HDMI input signal from the connected HDMI device.

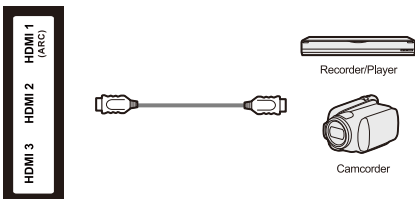

Note:

- 1) If the external device has a DVI output only, use a DVI to HDMI adapter cable to connect to the HDMI terminal.
- 2) HDMI1 supports ARC(Audio Return Channel) function, and you can connect ARC-enabled device with the TV by HDMI1 terminal.

4. USB

Connect USB devices to the TV.



Note: Never remove the USB device or turn off the TV while using the USB device.

5. ANTENNA IN

Connect a coaxial cable to receive signal from the antenna or cable.

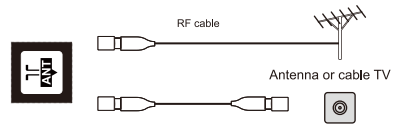

Note:

- 1) Do not place the RF cable under the TV.
- 2) To obtain the optimum quality of picture and sound, an aerial, the correct cable (75Ω coaxial) and the correct terminal are required.
- 3) If a community antenna system is used, you may require the correct connection cable and plug between the wall aerial socket and the TV.
- 4) Your local Television Service Center or dealer may be able to assist you in obtaining the correct aerial system for your particular area and the accessories required.
- 5) Any matters regarding aerial installation, upgrading of existing systems or accessories required, and the costs incurred, are the responsibility of you, the customer.

6. AV IN

Receive audio and video signal from signal source such as DVD.

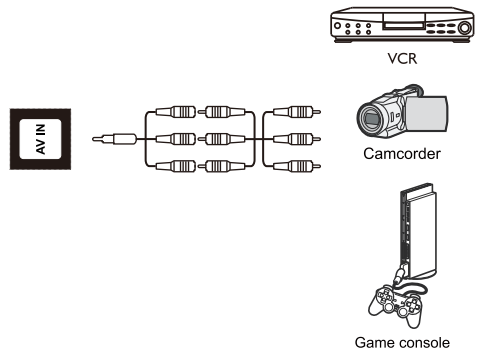

TV Controls

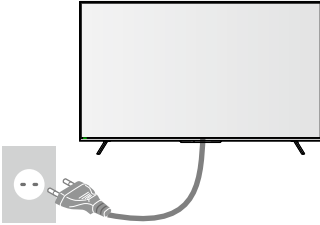

■ Power Connection



Note: The picture is only for reference.

Connect the power cord to the TV and the power outlet (100-240V ~ 50/60Hz).

■ Turn on or turn off the TV

1. Connect the power cord to the power outlet and the TV.
2. In standby mode, press **POWER**  button to turn on the TV.
3. In working status, press **POWER**  button to turn the TV to standby mode.
4. Disconnect the power cord to power off the TV completely.

■ Power Indicator

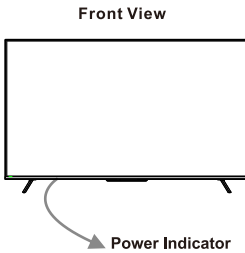

Note: The picture is only for reference.

- **Lit in Red:** Standby mode.
- **Lit in Green:** Working status.
- **Unlit:** Power off.

■ TV Control Button

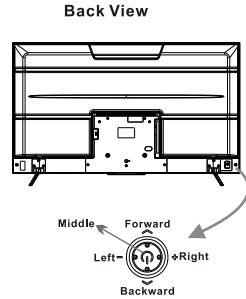

Note: The picture is only for reference.

Press Middle:

1. In standby mode, press it to turn on the TV.
2. In working status,
 - Without the source list, short press it to access the source list.
 - With the source list, short press it to enter the selected source.
 - Long press it to exit the source list or turn the TV to standby mode.

Push Left/Right:

Adjust the TV sound volume.

Push Backward/Forward:

Switch channels, or select the input source in source list.

Remote Control

Note:

- 1). The picture is only for reference.
- 2). The image, buttons or functions of remote control may vary depending on the region, model, app or source.
- 3). Some DTV-related buttons may not be applicable due to non-availability of DTV signal in some areas.

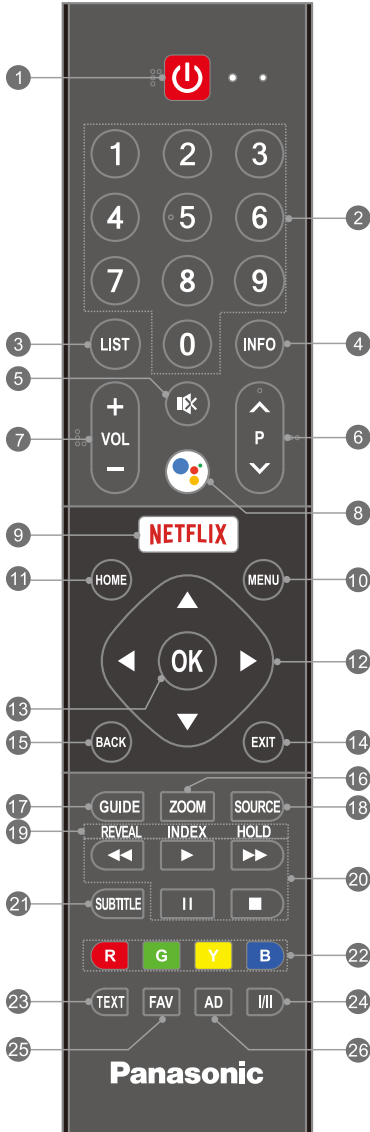

1. **POWER** (): Turn the TV on or to standby mode.
2. **Number Buttons (0-9)**: Choose the channel directly.
3. **LIST**: Access the channel list.
4. **INFO**: Access the INFO interface.
5. **MUTE** (): Mute or restore the sound.
6. **Program Up/Down (P \wedge / \vee)**
Change to next or previous program.
7. **Volume Up/Down (VOL +/-)**
Increase or decrease the sound volume.
8. **MIC** (): Start using the near field voice function.
9. **NETFLIX**: Access the application of Netflix.
10. **MENU**: Access the main menu.
11. **HOME**: Enter the home page.
12. **UP/DOWN/LEFT/RIGHT (\blacktriangle / \blacktriangledown / \blacktriangleleft / \blacktriangleright)**
Navigate the menu to select what you want.
13. **OK**: Confirm or enter the selected content, or access the list of "Quick Button".
14. **EXIT**: Exit the current operation.
15. **BACK**: Back to the upper-level menu.
16. **ZOOM**: Select the aspect ratio.
17. **GUIDE**: Access the EPG interface.
18. **SOURCE**: Select the input source.
- 19 & 23. **Teletext Buttons**
 - **TEXT**: Enter or exit the teletext menu.
 - **REVEAL**: Display the concealed information.
 - **INDEX**: Display the index page.
 - **HOLD**: Hold the teletext page on screen without updates or changes.
20. **USB Play Control Buttons**
 - **PLAY** (\blacktriangleright): Start the playback.
 - **PAUSE** (\parallel): Pause the playback, or enable Time-shift function in DTV mode.
 - **Stop** (\blacksquare): Stop the playback.
 - **Fast Backward** ($\blacktriangleleft\blacktriangleleft$): Fast backward the playback.
 - **Fast Forward** ($\blacktriangleright\blacktriangleright$): Fast forward the playback.
21. **SUBTITLE**: Open or close the subtitle.
22. **Color Buttons (RED/GREEN/YELLOW/BLUE)**
Execute the prompt function in specific mode.
24. **I/II**: Select Audio language depending on the broadcasting program.
25. **FAV**: Access the list of favorite programs.
26. **AD**: Turn on or turn off the function of audio description.

Voice Function

■ Far Field Voice

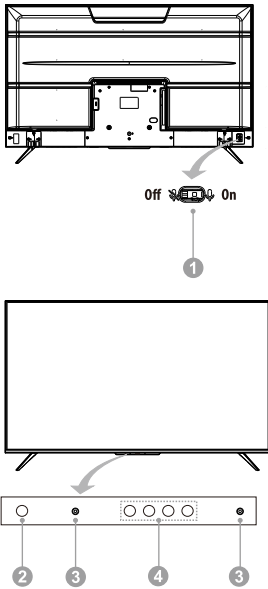

1. Switch of Far Field Microphones

Turn on or turn off the microphones of far field voice function. Only after turning on the far field microphones, successfully connecting your TV to the network and signing in to your Google account, you can start to use the far field voice function by saying the hotword: "Ok Google" or "Hey Google".

2. Power Indicator

Indicate the status of the TV power.

- * Lit in green: working mode.
- * Lit in red: standby mode.
- * Unlit: power off.

3. Far Field Microphone

Microphones of far field voice function. It is best to keep yourself within 3 meters away from the far field microphones while using the far field voice function.

4. Far Field Indicator

Indicate the status of far field microphones and far field voice function.

- * Lit in white: far field microphones are turned on, and far field voice function is being used.
- * Unlit: far field microphones are turned on, and far field voice function is not being used.
- * Lit in orange: far field microphones are turned off.

■ Near Field Voice

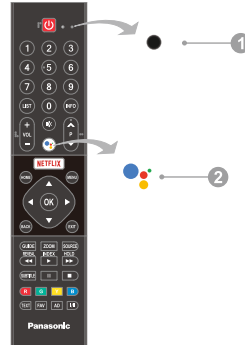

1. Near Field Microphone

Microphone of near field voice function. It is best to keep your mouth within 5 centimeters away from the near field microphone while using the near field voice function.

2. Mic Button of Near Field Voice Function

Press to start using the near field voice function Only after successfully connecting your TV to the network, pairing the Bluetooth remote control with your TV and signing in to your Google account, you can press mic button to start using the near field voice function.

How to Pair Bluetooth Remote Control with the TV

Note:

- 1) The pictures are only for references.
- 2) This is a Bluetooth remote control. Before using it, please pair it with the TV.
- 3) If you wait for more than 2 minutes and it can't pair, please repeat the following steps for pairing again.

When you finish the "Initial Setup", your Bluetooth remote control should have been paired successfully with the TV. Please operate as Step 1~3 to check it.

Step 1: Press **HOME** button to enter the home page.

Step 2: Click "Settings" on the home page.

Step 3: Enter "Remote & Accessories" in "General Settings". Please check if your Bluetooth remote control, named "TV BLE Remote", has been connected.

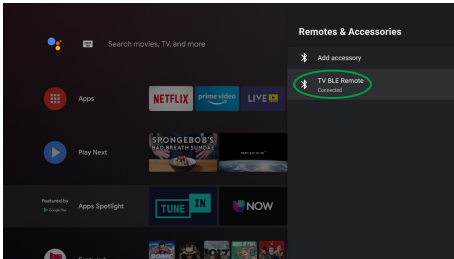

If it is not connected successfully in initial setup, you will find the searching interface after entering "Remotes & Accessories". Please operate as Step 4~8 to pair it manually by yourself.

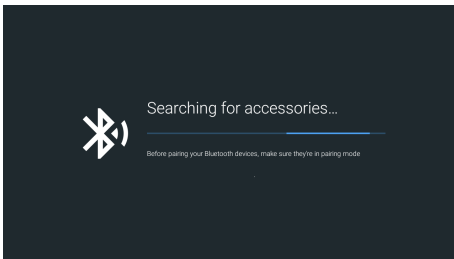

Step 4: Press **HOME** and **◀** button together for a while until there shows the name of your Bluetooth remote control on the TV searching interface. The LED of remote control turns green and starts blinking continuously.

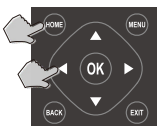

Step 5: Check and select the name, and the default name is "TV BLE Remote".

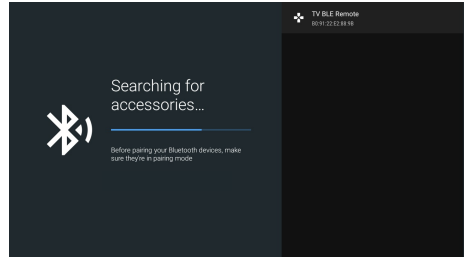

Step 6: Press **OK** button to start pairing the Bluetooth remote control. The screen will display "Pairing..."

Step 7: Then the screen will display "Connecting..."

Step 8: The screen will display "Paired" and green LED will stop blinking temporarily if the remote control is paired successfully. It will turn green and blink once each time when you press any button of the remote control.

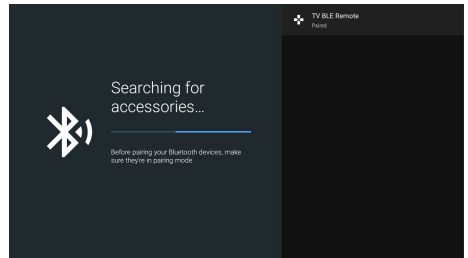

•The LED status of remote control in Bluetooth and infrared modes.

Continuous blinking of green LED	In Bluetooth pairing mode, the LED of remote control turns green and keeps blinking continuously.
One blinking of green LED	In Bluetooth using status after paired successfully, the LED of remote control turns green and blinks once each time when you press any button.
One blinking of red LED	In infrared using status, the LED of remote control turns red and blinks once each time when you press any button.

Initial Setup

When you turn on the TV for the first time, there will show a wizard to guide you to finish the following initial settings:

Step 1: Connect the Bluetooth remote control. If you haven't a Bluetooth remote control, please just skip it.

ⓘ Please hold down the HOME and LEFT button at the same time, and then press the MIC button to pair.



Step 2: Select the menu language as you need.

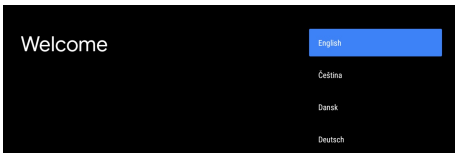

Step 3: Select whether or not to use an Android phone to setup the TV.



Note: If you don't want to use your Android phone to setup the TV, you can skip directly to Step 4. If you want to use your Android phone to setup the TV, please operate as the following instructions.

< Instructions to Setup the TV with Your Android Phone >

- Turn on the Bluetooth functions of your Android phone, then find and open "Google" application on your phone.

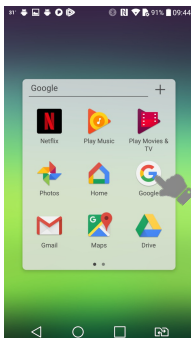

- Click "🗣️" icon, then say "Ok Google, setup my device".

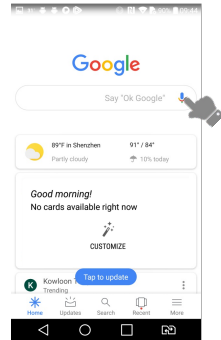

- When there shows "Getting started", please click "Next" to search for devices.

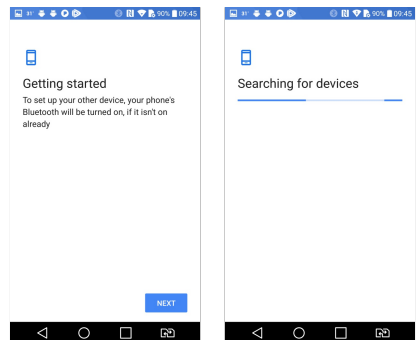

- Select the name of your TV, which is same as that shown on the TV screen. TV name may vary depending on the region or model.

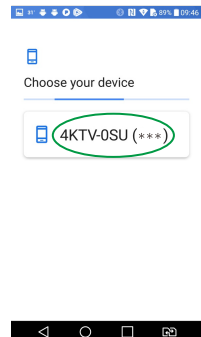

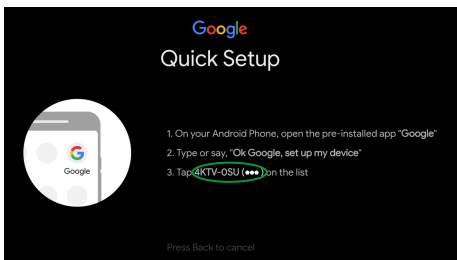

- Verify to make sure that the code shown on your phone is same as that shown on the TV screen. Then click "Next" to connect the TV with your phone.

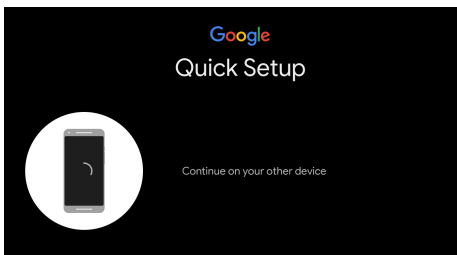
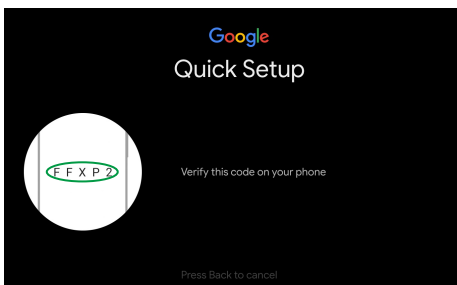
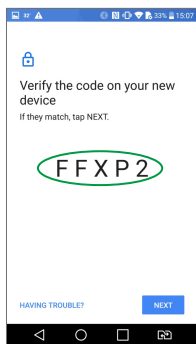

- Connect your phone to the selected wireless network, then choose your Google account.

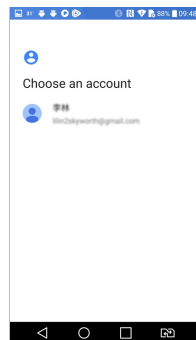
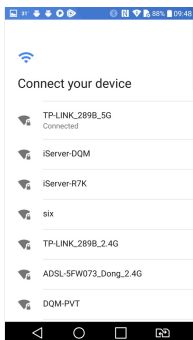

- Copy your Google account to the TV.

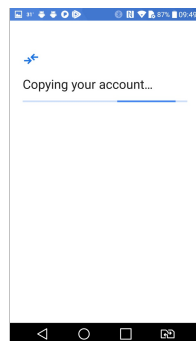
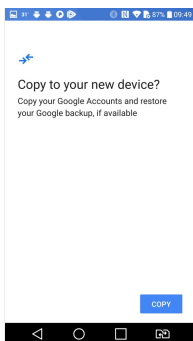

- Input your password and finish setting up the TV with your Android phone.

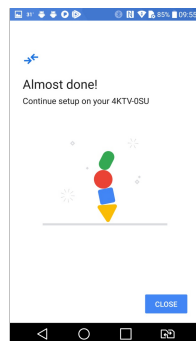
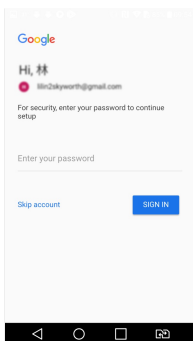

Step 4: Select whether or not to connect your TV set to the wireless network. This will not display if you have connected this TV to the wired network.

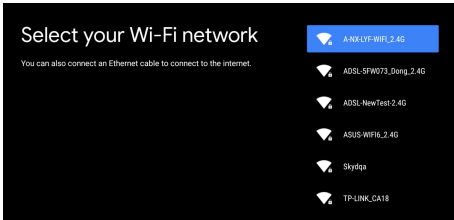

Note: If you have connected the TV to the wireless network, it will check for updates like Google service updates and so on. Then please select whether or not to sign in to your Google account.

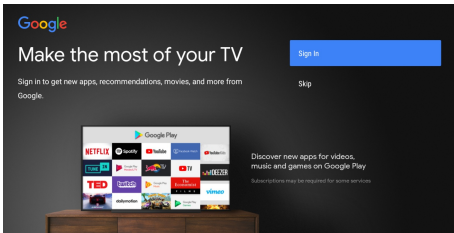

Step 5: Read to accept the Google terms of service and privacy policy.

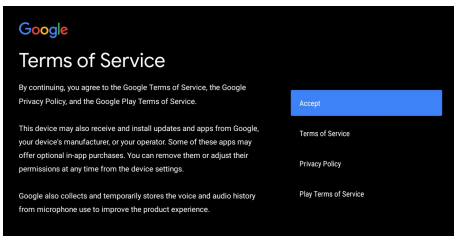

Step 6: Select whether or not to let Google or third party to use your TV location.

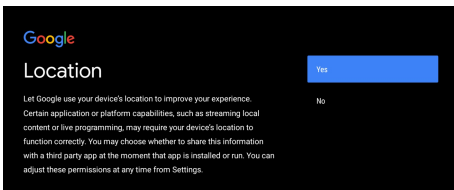

Step 7: Select whether or not to allow Google to help improve your Android TV.

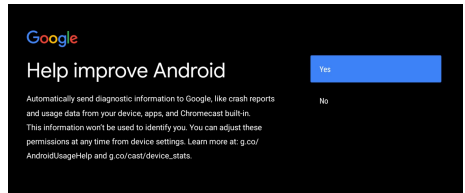

Step 8: Introduction on main functions of your Android TV.

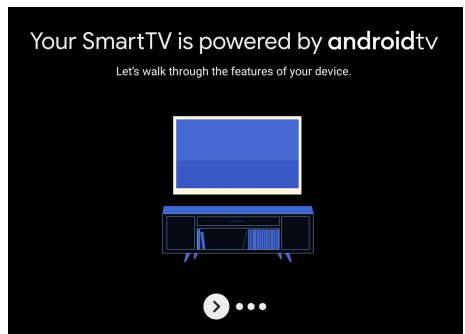

Step 9: Select and install the recommended applications from Google. This step may not be available depending on Google service. Applications shown here vary by different models or regions.

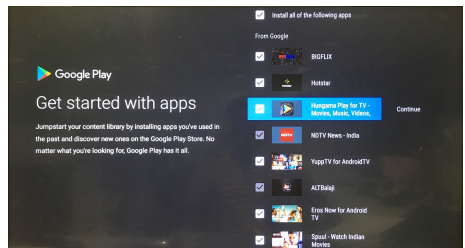

Step 10: Read the end user license agreement.

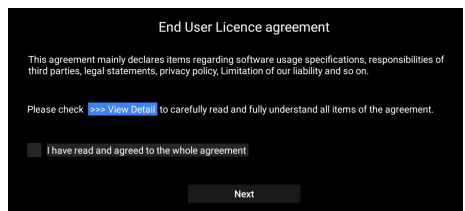

Step 11: Choose the TV usage environment between “Home” and “Shop”.

Note: “Home” mode is recommended for home viewing, while “Shop” mode is used to demonstrate the TV in a shop and the like. It will consume more energy in “Shop” mode.

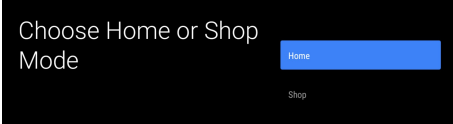

Step 12: Select your country.

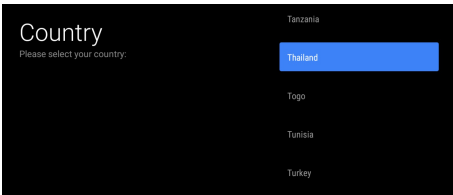

Step 13: Turn on or turn off the LCN switch (Logical Channel Number).

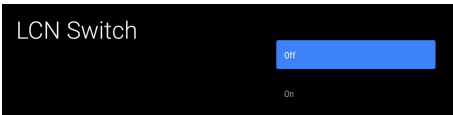

Step 14: Input your local postal code. It is only available for Indonesia.



Step 15: Select the country region. It is only available for Australia.

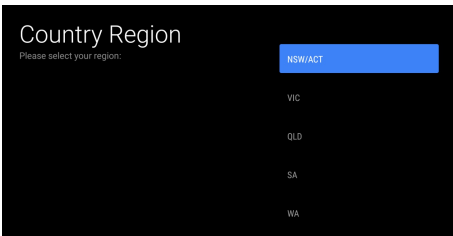

Step 16: Select the TV source.



Step 17: Select the program type.

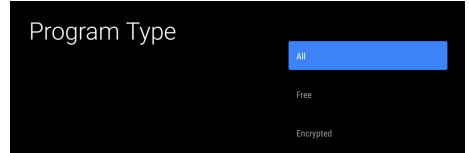

Step 18: Select whether or not to start “Channel Scan”.

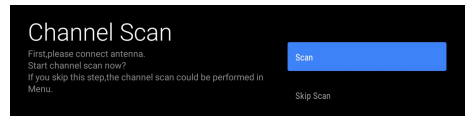

Note:

- 1) The pictures are only for references, and please refer to actual screens of your Android TV or phone for clear images and correct contents.
- 2) Initial settings may change without notice, which depends on Google requirements. You need to finish all initial settings according to what is indicated on the screen.
- 3) If you want to restart the initial setup after the first time, please select <HOME → Settings → General Settings → Device Preferences → Reset>.

Selecting the Input Source

1. Press **SOURCE** button to access the list of input sources.
2. Press **▲/▼** button to select the desired input source.
3. Press **OK** button to access the selected input source.



Note:

- 1) The picture is only for reference.
- 2) The source of **Google Play Movies & TV** will be available only after you update the TV system, connect the TV to the network, and login to your Google account.

Electronic Program Guide

Electronic Program Guide is supplied by the program providers and offers information about the programs to be broadcast. You can access it in DTV mode by pressing **GUIDE** button on the remote control.

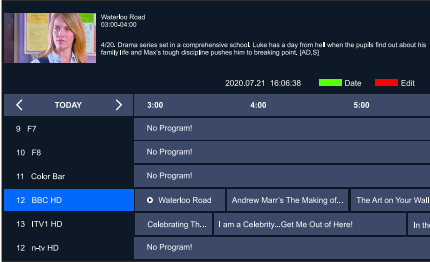

Note: The picture is only for reference.

- Press **RED** button to edit the selected program.
Remind: Setup a watching appointment to remind you of viewing the selected program.
Schedule: Show the list of watching appointments.
- Press **GREEN** button to skip to the position where you can change the date by pressing **◀/▶** button.

Time Shift Function

Time-shift is used to record a DTV program when your viewing is interrupted or delayed. Press **II** button to pause playing the DTV program and start to record the program. Press **▶** button to continue playing the program from when you paused. Press **■** button to call out a prompt reminder, asking you whether or not to stop the time-shift function.

Note:

- 1) Before time-shift, you'd better format your **USB** device to ensure there is enough space for time-shift recording.
- 2) The recorded program of time-shift will be cleared automatically after playing the program or stopping time-shift function.
- 3) If time-shift recording lasts too long, and there is no more space for recording new program, the TV will start to play the program automatically from the recording beginning to release the space of program which has been played for new program recording.
- 4) If you want to change the settings for Time Shift function, please select **<MENU → More → TV Setting → Setup → TimeShift Setting>**.

Quick Menu Settings

- Step 1:** Press **MENU** button to enter quick menu settings.
- Step 2:** Press **▲/▼** button to select a submenu: **Picture Mode, Sound Mode, Sleep Timer, Source** or **More**.
- Step 3:** Press **OK** button to enter the selected submenu.
- Step 4:** Press **▲/▼** or **◀/▶** or **OK** button to adjust or enter the submenu.
- Step 5:** Press **EXIT** button to exit quick menu settings.

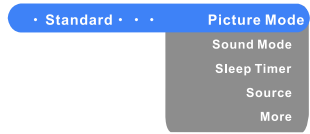

- **Picture Mode:** Select the picture mode.
- **Sound Mode:** Select the sound mode.
- **Sleep Timer:** Setup the sleep timer in minute to turn off the TV automatically.
- **Source:** Select the input source.
- **More:** Access main menu settings.

Note:

- 1) The pictures is only for reference.
- 2) Quick menu settings may vary depending on the input sources.

Main Menu Settings

- Step 1:** In quick menu settings, select "More" to enter the main menu settings.
- Step 2:** Press **▲/▼/◀/▶** and **OK** buttons to select and adjust an item.
- Step 3:** Press **BACK** button to back to the upper-level menu.
- Step 4:** Press **EXIT** button to exit main menu settings.

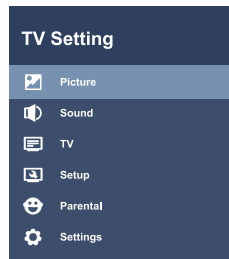

Note:

- 1) The pictures are only for references.
- 2) Some settings may vary depending on the region, model or input source.

- **Picture:** Adjust the settings related to the picture quality.

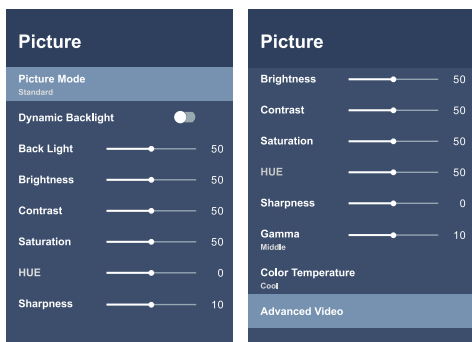

Picture Mode	Select the picture mode. Choices are Vivid, Standard, Sport, User, Movie and so on, which may vary by different input sources.
Dynamic Backlight	Turn on to automatically adjust the screen backlight depending on the input source.
Back Light	Adjust the backlight of the screen.
Brightness	Adjust the lightness of the picture.
Contrast	Adjust the difference between light and dark areas of the picture.
Saturation	Adjust the colorfulness of the color relative to its own brightness.
HUE	Adjust the color tint of the picture.
Sharpness	Adjust the edge of the picture.
Gamma	Adjust the light intensity of original image. Choices are Dark, Middle and Bright.
Color Temperature	Adjust the overall color tone of the picture.
Advanced Video	(May vary depending on the region or model) * Remove the noise from the picture signal. * Adjust the luma of the picture automatically depending on the input signal. * Control local contrast. * Reduce the noise created while compressing or converting the MPEG signal. * Suppress the image jitter to achieve a stable and fluent play of the dynamic picture.

- **Sound:** Adjust the settings related to the sound effect.

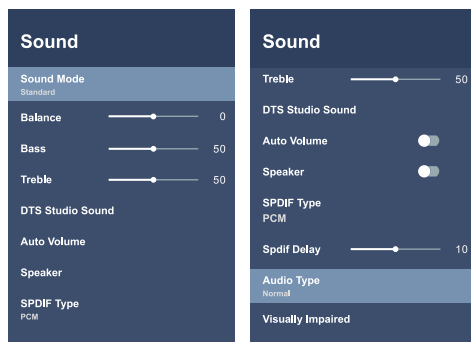

Sound Mode	Select the sound mode. Choices are Standard, Music, Sport, Movie.
Balance	Control the sound balance between left and right speakers.
Bass	Adjust the low frequency of the sound.
Treble	Adjust the high frequency of the sound.
DTS Studio Sound	Turn on or turn off the sound system of DTS Studio Sound.
Auto Volume	Turn on to adjust the sound volume automatically depending on the input signal.
Speaker	Turn on or turn off the TV speaker.
SPDIF Type	Select the type of digital audio output. Choices are Off, Auto, Dolby Digital, PCM and PassThrough.
Spdif Delay	Select the delay value of digital audio output.
Audio Type	Select the type of audio output. Choices are Normal and Visually Impaired.
Visually Impaired	Adjust Speaker and Volume to help the visually-impaired viewers understand and enjoy the program. It is available only after "Visually Impaired" has been selected in "Audio Type".

- **TV:** (Only for TV mode) Search for channels automatically or manually.

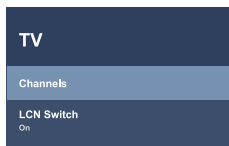

Channels	Search for channels automatically or manually.
LCN Switch	Turn on to get the channel number automatically from the program. It is only available for DTV mode.
HBTV	Turn on or turn off HBTV function. It is only available for some countries.

Teletext	* Select the digital teletext language. * Select the decoding page language.
HDMI 2.0 Setting	Select HDMI signal format. Choices are HDMI 1.4 and HDMI 2.0.
Postal Code	Input your local postal code. It is only available for Indonesia.
End User Licence Agreement	Read the end user license agreement.
TimeShift Setting	Setup for the best usage of Timeshift function.
Reset Default	Reset user settings to the factory default values.

- **Setup:** Adjust settings related to the TV, channel or program.
- **Parental:** Setup the lock system.

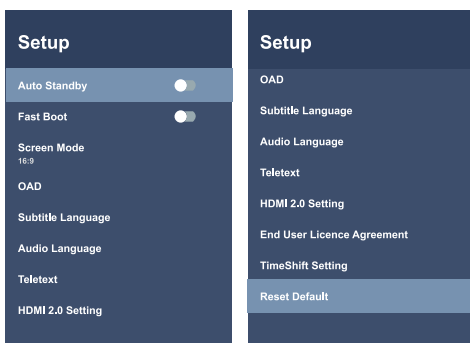

Auto Standby	Open it to turn off the TV automatically when there are signals but no operations for 4 hours.
Fast Boot	Turn on or turn off the function of fast boot. If you turn on it, and press POWER button to close the TV, then the TV will close, but the system still runs continuously. In such case, it will consume more energy, but it could take short time to turn on the TV again.
Screen Mode	Select the desired screen mode. Choices are Auto, 16:9, 4:3, Panorama, Zoom and P2P, which vary by different input sources. It is available only after you have searched TV channels.
OAD	Turn on or turn off the function of OAD manual download. It is only available for some countries.
Subtitle Language	* Select the digital subtitle languages. * Select the subtitle type. "Hearing Impaired" is used to help the hearing-impaired viewers understand and enjoy the program.
Audio Language	Select the audio languages.

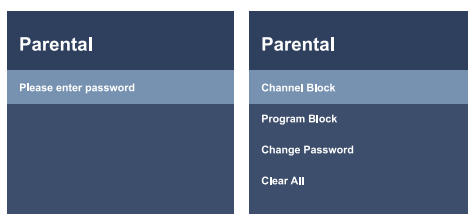

Please enter password	Password is needed for entering the lock system. The initial password is "0000".
Channel Block	Restrict unauthorized access to specific channel based on the channel information. It is only available for TV mode.
Program Block	Restrict unauthorized access to specific program based on the age rating.
Change Password	Change the password of lock system. If you forget your password, you can use the super one "8899" to enter the lock system.
Clear All	Clear all user settings in lock system.

- **Settings:** Adjust the settings related to your Android TV system.

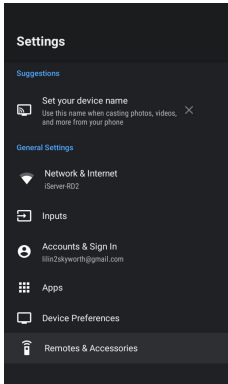

Suggestions	Show the recommended or unfinished settings for the best usage of your TV.
Network & Internet	<ul style="list-style-type: none"> * Connect the TV to the wireless or wired network. * Adjust settings related to the network configuration. * Setup WOW/WOL function to turn on the TV from standby mode by your mobile device through network connection.
Inputs	<ul style="list-style-type: none"> * Setup the input sources. * Setup to control the connected HDMI devices.
Accounts & Sign in	Sign in to your Google Account for new apps, recommendations, movies and more from Google.
Apps	<ul style="list-style-type: none"> * Show the list of recently-opened, installed or system apps. * Setup specific app permissions.
Device Preferences	<ul style="list-style-type: none"> * Show basic device information. * Adjust settings related to the system and features of your Android TV device. * Setup the home page channels and application restrictions. * Restart the initial setup. ...
Remotes & Accessories	<p>Search and connect the Bluetooth remote control or other Bluetooth devices.</p> <p>Note: Before Bluetooth searching, please make sure you have turned external Bluetooth devices in the pairing mode. For the remote control, you can press ◀ and HOME buttons together to open its pairing mode. For other Bluetooth devices, please read their own instruction manuals for opening the pairing mode.</p>

Chapter 3: Smart Features

Home Page

Please press **HOME** button to enter the home page to enjoy the following functions.

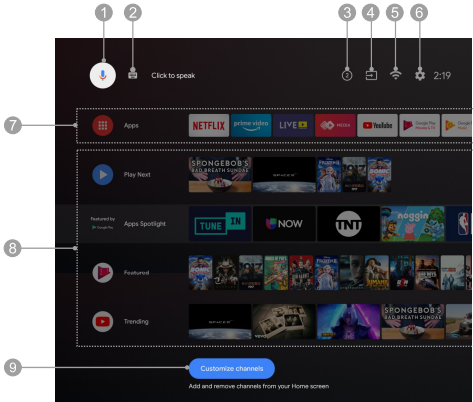

Note: The picture is only for reference.

- 1. Google Assistant:** Click to interact with Google Assistant of the TV.
- 2. Text Searching:** Click to start the searching by typing the text.
- 3. Notifications:** Remind you of system-critical information, such as low disk space, Google sign in or account errors, network connectivity issues, etc.
- 4. Inputs:** Select the input source.
- 5. Network Status:** Show the status of TV network connection.
- 6. Settings:** Access the main menu settings.
- 7. Apps:** Show the list of favorite applications, or access the application center.
- 8. Favorite Channels:** Show the content list of customized channels, which is selected and managed at "Customize Channels". Empty channels will not be shown.
- 9. Customize Channels:** Add or remove the desired channel onto or from the home page.

Note:

- 1) The functions or contents of "Home Page" may vary by different countries or models.
- 2) Before using network functions in home page like network applications and so on, please connect the TV to the network firstly.
- 3) Icon copyrights are owned by the application providers.

Google Assistant

- Google Assistant is available on your Android TV as your virtual personal helper. Press **MIC** button on your remote control to start and enjoy it. It is so wonderful that you will love it instantly! With Google Assistant, you can get what you want easily and quickly by using the power of your voice.
- There is no complicated or boring text typing, and what you need to do is just speaking to your TV.

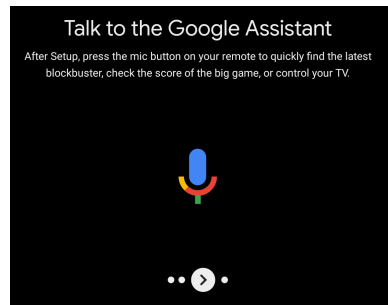

- If you want to know the detailed functions of Google Assistant, please ask Google Assistant "What can you do", then there will show the list with kinds of functions on the screen to tell you what Google Assistant can do for you.

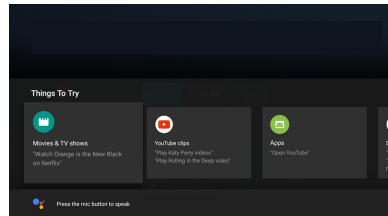

- Before using Google Assistant, please make sure that you have connected your TV to the network, and that you have paired your Bluetooth remote control with the TV successfully, and also that you have signed in to your Google Account.

Note:

- 1) The pictures are only for reference.
- 2) Google Assistant is only available in some regions or some languages. Before using it, please make sure that you have paired your Bluetooth remote control with the TV successfully.

Google Play

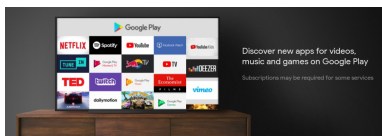
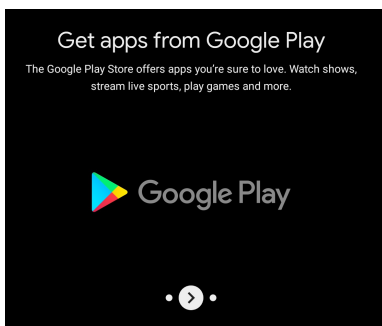

■ Google Play Store

“Google Play Store” is the official application market which is developed and operated by Google. You can search and download the free or paid application as you want. The followings are only for your reference to search and download a web browser:

- 1) Select <HOME → Apps → Google Play Store> to enter the application market.
- 2) Search for “Web Browser” & download the desired browser.
- 3) Install it on your TV, then its icon will be displayed in the application center.
- 4) Click “Apps” on home page to enter the application center.
- 5) Select the installed browser and long press **OK** button to enter the menu of application management.
- 6) Select “Add to favorites” to add the browser to the list of favorite applications on home page.

■ Google Play Music

“Google Play Music” is an online music center, where you can search and listen to the free or paid music as you like.

■ Google Play Games

“Google Play Games” is a game application center, where you can search and download the free or paid game application as you like.

■ Google Play Movies & TV

“Google Play Movies & TV” is a service center offering movies and television shows available for your purchase or rental.

Note:

- The picture is only for reference.
- The functions and contents of “Google Play” may vary by different countries or models. Play store & applications are controlled by Google & are subjected to regional availability.
- To use the functions of “Google Play”, you must have connected the TV to the network, and have signed in to your Google account.
- According to circumstances of the content provider, an application’s updates or the application itself may be discontinued.
- Changes in application content may be made without prior notice by the service provider.
- Manufacturer does not warrant or be responsible for any complaint or defect caused due to installation of third party applications.

Chromecast Built-In

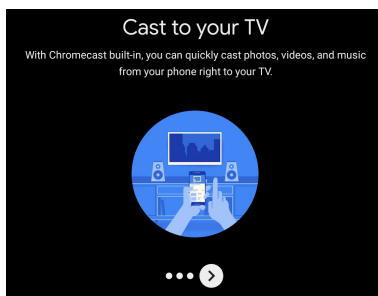

■ Definition of Chromecast Built-in

“Chromecast Built-In” is a casting technology developed by Google that enables your mobile device or personal computer to initiate and control playback of internet-streamed audio/video content on the TV.

■ How to Cast Content

“Chromecast Built-In” offers two methods to cast content:

- * The first employs mobile device and web apps that support Chromecast Built-In technology.
- * The second allows mirroring of content from the web browser “Google Chrome” (with cast extension) running on a personal computer. In both cases, playback is initiated through the cast icon “” on the sender device.

■ Cast Screen/Audio (like Google Home)

Cast your mobile device's screen and audio to the TV.

Step 1: Connect your phone and the TV to the same wireless network successfully.

Step 2: Select and access "Home" application from your phone, then click "👤" to enter the account page.

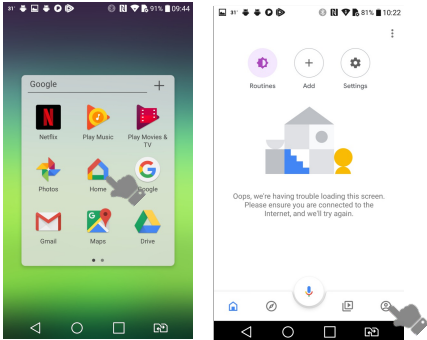

Step 3: Select and access "Mirror device", then select the name of the TV to connect the TV with your phone.

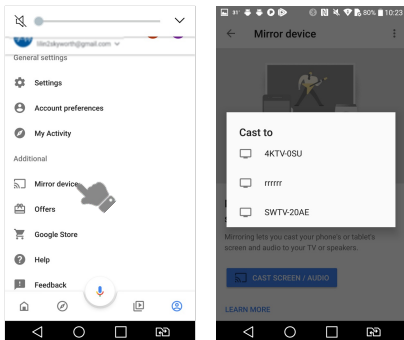

Step 4: The contents on the screen of your phone has been completely cast onto the TV big screen. Click "DISCONNECT" to stop casting.

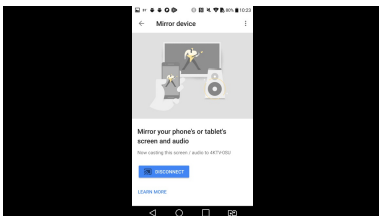

■ Cast Live streams and Videos (like YouTube)

Cast your mobile device's live streams and videos to the TV.

Step 1: Connect your phone and the TV to the same wireless network successfully.

Step 2: Select and access "YouTube" application from your phone.
Step 3: Select the content you like, then click cast icon "📺" to cast the site link of the content to the TV for playing the content by the TV instead of your phone. Click cast icon "📺" again to stop casting.

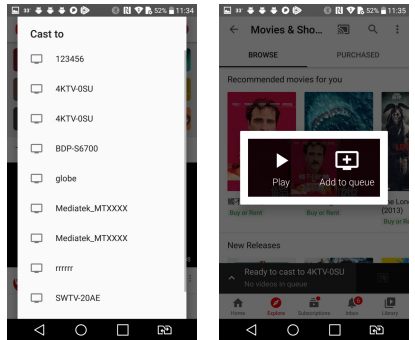
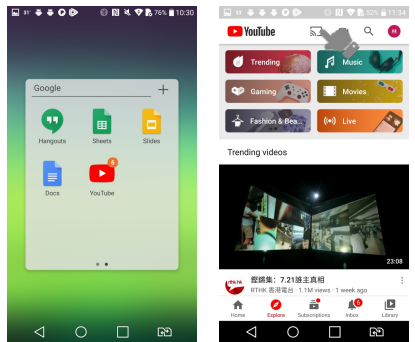

Bellow buttons you can use on remote control while playing videos:

▶ /	Play / Pause
◀ / ▶▶	Fast Backward / Fast Forward
■	To stop the video

Note:
 1) The pictures are only for references, and please refer to actual screens of your Android phone for clear images and correct contents.
 2) For above YouTube cast feature, both smart phone & the TV should be connected to the same network.

Disclaimer about Using Android

Network application contents and services are controlled by network application providers by means of networks and transmission facilities, which are subject to alteration, suspension, removal, termination or interruption, or invalid access at any time without further notice in that the manufacturer is unable to control or to be informed of the aforesaid change. The manufacturer makes a further declaration that it disclaims any responsibility or liability arising from customer's failure to use the network application contents and services caused by, including but not limited to, failure of network connection or communication lines, technological updates, or the alteration, suspension, interruption, termination, disabling, or removal of any contents or services by the network application providers etc.

Note:

- Some USB storage devices may not be compatible to operate smoothly with this TV.
- Back up all of the data in the USB storage device in case data was lost due to an unexpected accident.
- We do not assume any liability for the losses by misuse or malfunction. Data backup is consumer's responsibility.
- For large file sizes, the loading speed may be slightly longer.
- The recognition speed of a USB storage device may depend on each device.
- When connecting or disconnecting the USB storage device, ensure that the TV is not in USB mode otherwise the USB storage device or the files stored in it may be damaged.
- Please use only a USB storage device which is formatted in FAT16, FAT32, NTFS file system provided with the Windows operating system. In case of a storage device formatted as a different utility program which is not supported by Windows, it may not be recognized.
- When using a USB Hard Disk Drive which requires electric power source, ensure its rated power does not exceed the current marked at the USB terminal. If the power of the USB hard Disk exceeds the marked current, the TV system will be changed into standby mode, then you must pull away the USB Hard Disk and restart the TV system.
- An "Unsupported File" message will be displayed if the file format is unsupported or corrupted.
- FHD big picture needs longer time to process, which is not caused by the TV. Please be patient to wait.
- This TV may not support some multimedia files changed and upgraded as the change of encoding format or other technical advances.
- Use high-quality mobile device to record HD programs, otherwise the videos will be jammed during the playback. Back up all of the data in the USB storage device in case data was lost due to an unexpected accident.
- We do not assume any liability for the losses by misuse or malfunction. Data backup is consumer's responsibility.
- Do not power off the TV during the software upgrading process, otherwise the TV may not work, and the customer should be responsible.

- Manufacturer does not guarantee the operation of third-party web browsers. Third-party apps that have been downloaded and installed from the Google Play store are supported by the company or developer who produced them.
- The browser may not support some web pages or videos due to network, region, format or internet service provider, which has nothing to do with the TV.
- Each trade mark indicated on this TV are the property of each trademark right holder, and all rights are reserved by them.
- The browser may stop responding, if the size of website is too large.
- For better & smooth experience, please delete web browser history regularly.

Multimedia Player

■ Preparation

- Insert your USB device on the TV to view compatible photo and movie on the TV screen or play compatible music through the TV.
- If the connected USB hard disk does not have an external power source, it may not be detected. Be sure to connect the external power source.
- To avoid losing the data on your USB device or damaging your USB device, it is recommended that you back up all data on your USB device.
- The control menu displays in media player may differ by different regions or models. And please take your actual TV as the standard.
- If you want to pull out your USB device, please exit USB mode firstly.
- For instructions on using your USB device, refer to the owner's manual of your USB device.
- Never remove the USB device or turn off the TV while using the USB device. Doing so may result in loss of data or damage to the USB device or the TV.
- Certain types of USB devices may not be compatible with the TV.

■ Media Operation

Please select <HOME → Apps → Multimedia Player> to open the media player where you can play the selected media file on the TV screen.

- Step 1:** Connect your USB device to the TV.
- Step 2:** Press **HOME** button to enter the home page.
- Step 3:** Press **▲/▼/◀/▶** and **OK** button to select and enter "Apps".
- Step 4:** Press **▲/▼/◀/▶** and **OK** button to select and enter "Multimedia Player".
- Step 5:** Press **▲/▼/◀/▶** and **OK** button to select and play the desired media file.
- Step 6:** Press **OK** button to start the playback.
- Step 7:** Press **BACK** button to exit the playback.

■ Watch Movies

While watching a movie, press the following buttons to control the movie playback.

Button	Function
OK	Without control bar, call out the control bar.
	With control bar, pause or play.
MENU	Access the quick menu.
▲	Access movie menu settings.
▼	Show the movie playlist.
◀/▶	Fast backward or fast forward.
◀◀/▶▶	

■ Play Music

While playing music, press the following buttons to control the music playback.

Button	Function
OK	Pause or play.
MENU	Access the quick menu.
▲	Access music menu settings.
▼	Show the music playlist.
◀/▶	Short press to previous or next piece of music.
	Long press to fast backward or fast forward.
◀◀/▶▶	Fast backward or fast forward.

■ Browse Photos

While browsing a photo, press the following buttons to control the photo playback.

Button	Function
OK	Access photo menu settings.
MENU	Access the quick menu.
▲/▼	Show the photo playlist.
◀/▶	Skip to previous or next photo.

■ Supported File Formats in Multimedia Player

Type	Formats
Video	Video Codec: H.263, H.264, H.265, VP9, MPEG2, MPEG4, HDR10, HLG, AV1
	File Extension Name: avi, dat, mpeg, mpe, mpg, vob, mp4, mov, mkv, ts, tp, trip, m2ts, mts, m4v, f4v, flv, asf, 3gp, webm
Audio	Audio Codec: Dolby MS12, AMRNB, AAC, PCM, MP3, G711, HEAAC
	File Extension Name: mp3, AAC, m4a, flac, amr, mp2, mpga, ogg, AC3, wav
Photo	jpg, jpeg, png, bmp, gif

Note:

- Under the following conditions, this system cannot decode the file and the file cannot be played normally:
 - The parameters of file, such as the pixel of picture, code rate of audio and video file, sampling rate of audio file, exceed the limit of the system;
 - The format of file is not matched or the file is harmed.
 Note: The code rate this system supports does not exceed 20Mbps.
- Hot plug: Do not disconnect when the system is reading or transmitting data, avoid damaging the system or the device.
- Pay attention to the power supply of the device when you are using a mobile hard disk or a digital camera. If the power supply is not sufficient or not stable, you may encounter problems during operating or can not operate at all. In this case, please restart the device, or unplug the device and plug it again, and ensure that its power supply is normal.
- The system supports standard USB1.1, USB2.0 and USB3.0 devices, such as standard U-disks, MP3 players, mobile hard disks, etc..
- For obtaining better audio and video quality, It is suggested to use the external device which accords with USB2.0 standard.
- When playing the video with high compression ratio, these phenomenons, such as picture standstill and menu long time response, are normal.
- For some USB device with power supply, such as large size hard disk, MP4, etc., Suggest using it with power to avoid electric power shortage. -The parameters of file, such as the pixel of picture, code rate of audio and video file, sampling rate of audio file, exceed the limit of the system.
- The file may not be played normally because its parameters, such as the pixel of picture, code rate of audio and video file, sampling rate of audio file, exceed the limit of the system.
- Some files may not be played back even if they fulfil these conditions.
- The device may become unusable with this TV if the file or folder names are changed.

Maintenance

First, remove the mains plug from the socket outlet.

Regular care:

Gently wipe the surface of the display panel, cabinet, or pedestal by using a soft cloth to clean the dirt or fingerprints.

For stubborn dirt:

First clean the dust on the surface. Dampen a soft cloth with clean water or diluted neutral detergent (1 part detergent to 100 parts water).

Wring the cloth and wipe the surface.

Finally, wipe away all the moisture.

Mains plug

Wipe the mains plug with a dry cloth at regular intervals. Moisture and dust may lead to fire or electrical shock.



Caution

Do not use a hard cloth or rub the surface too hard, otherwise this may cause scratches on the surface.

- Take care not to subject the TV' surfaces to water or detergent Liquid inside the TV could lead to product failure.
- Take care not to subject the surface to insect repellent, solvent, thinner or other volatile substances. This may degrade surface quality or cause peeling of the paint.
- The surface of the display panel is specially treated and may be easily damaged. Take care not to tap or scratch the surface with your fingernail or other hard objects.
- Do not allow the cabinet and pedestal to make contact with a rubber or PVC substance for a long time. This may degrade surface quality.

Troubleshooting

Most problems you encounter with your TV can be corrected by consulting the following troubleshooting list.

No picture, no sound

- Check if the fuse or circuit breaker is working.
- Plug another electrical device into the outlet to make sure it is working or turned on.
- Power plug is in a bad contact with the outlet.
- Check the signal source.

No colour

- Adjust the saturation.

Remote control does not work

- Change the batteries.
- Batteries are not installed correctly.
- Main power is not connected.

No picture, normal sound

- Adjust the brightness and contrast.

Normal picture, no sound

- Press the Vol+ button to increase volume.
- Volume is set to mute, press the mute button to restore sound.

Radio frequency interference

This interference produces moving ripples or diagonal streaks, and in some case, loss of contrast in the picture. Find out and remove the radio interference source.

Bluetooth remote control can't be paired successfully

- Retry to pair remote control for more times.
- Change the batteries.

Can't sign in Google account

- Retry to sign in again.
- Use another device to check if there is something wrong with the network.
- Use another Android device to check if there is something wrong with the Google server.

Can't use Google Assistant

- Check if the Bluetooth remote control has been paired successfully.
- Use another device to check if there is something wrong with the network.
- Use another Android device to check if there is something wrong with the Google server.

Specifications

Model No.		TH-55HX750K	TH-65HX750K
Power Source		100 - 240 V ~ 50/60 Hz	100 - 240 V ~ 50/60 Hz
Power Consumption	Power Rating	150 W	200 W
	Standby Condition	< 0.5W	< 0.5W
Display Panel	Visible Screen Size	139 cm	165 cm
	Resolution	3840 X 2160	3840 X 2160
Dimensions (L X B X H)	with Pedestal	122.7 X 23.3 X 77.4 cm	144.8 X 27.2X 90.8 cm
	TV only	122.7 X 7.5 X 71.5 cm	144.8 X 8.1X 83.7cm
Net Weight		10.7 kg (with Pedestal) 10.5 kg (TV only)	17.9 kg (with Pedestal) 17.6 kg (TV only)
Gross Weight		14.5 kg	24.7 kg
Sound	Speaker	6 Ω	6 Ω
	Audio Output	10 W + 10 W	12 W + 12 W
TV System		DTV: DVB-T/T2/C	
		ATV: PAL BG/I/DK	
Connection Terminals	AV IN	Mini AV Connector x 1 (Need AV converting cable)	
	ANTENNA IN	Aerial Connector x 1	
	HDMI	HDMI Connector x 3	
	USB	USB 2.0 Connector x 2, DC 5 V, Max. 500mA	
	DIGITAL AUDIO OUT	Optical x 1	
	LAN IN	Network Connector x 1	

Note

1. Design and Specifications are subject to change without notice.
2. Weight and Dimensions shown herein are approximate
3. The graphics in this manual are only for reference.
4. Your TV may be slightly different from that shown in this manual.
5. In dry environment due to static electricity, the product may restart and return to the main OSD interface, USB player interface or the previous source mode. It is normal and please continue to operate the TV .

Built-in wireless LAN and Bluetooth specification

Built-in wireless LAN

Standard compliance and Frequency range*1

IEEE802.11a/n/ac:
5.18GHz-5.32GHz, 5.50GHz-5.70GHz

IEEE802.11b/g/n(HT20):
2412MHz to 2472MHz

IEEE802.11n(HT40):
2422MHz to 2462MHz

Security

WPA2-PSK (TKIP/AES)
WPA-PSK (TKIP/AES)
WEP (64 bit/128 bit)

Bluetooth wireless technology*2

Standard Compliance

Bluetooth V5.0

Frequency Range

2402 MHz – 2480 MHz

*1: The frequency and channel differ depending on the country

*2: Not all the Bluetooth compatible devices are available with this TV.

Customer's Record

The model number and serial number of this product may be found on its rear panel. You should note this serial number in the space provided below and retain this book, plus your purchase receipt, as a permanent record of your purchase to aid in identification in the event of theft or loss, and for Warranty Service purposes.

Model Number

Serial Number

Panasonic Corporation

Web Site: <http://www.panasonic.com>