

# Panasonic<sup>®</sup>

Operating Instructions

## CD Stereo System

---

Model No. **SC-MAX9000**  
**SC-MAX7000**  
**SC-MAX5000**

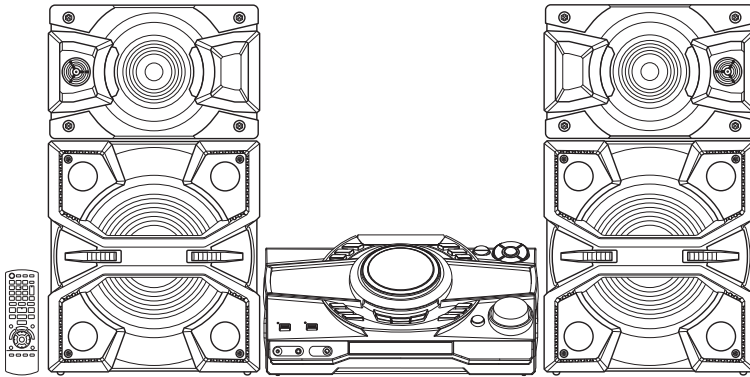

This illustration shows SC-MAX5000.

Thank you for purchasing this product.

For optimum performance and safety, please read these instructions carefully.

Please keep this manual for future reference.

These operating instructions are applicable for models SC-MAX9000, SC-MAX7000 and SC-MAX5000.

**SC-MAX9000**: Indicate features applicable to SC-MAX9000.

**SC-MAX7000**: Indicate features applicable to SC-MAX7000.

**SC-MAX5000**: Indicate features applicable to SC-MAX5000.

System	SC-MAX9000	SC-MAX7000	SC-MAX5000
<b>Main unit</b>	SA-MAX9000	SA-MAX7000	SA-MAX5000
<b>Speakers</b>	SB-MAX9000	SB-MAF7000 SB-MAG7000	SB-MAX5000
<b>Subwoofer</b>	–	SB-MAW7000	–

Unless otherwise indicated, illustrations in these operating instructions are of SC-MAX9000. Your system and the illustrations can look differently.

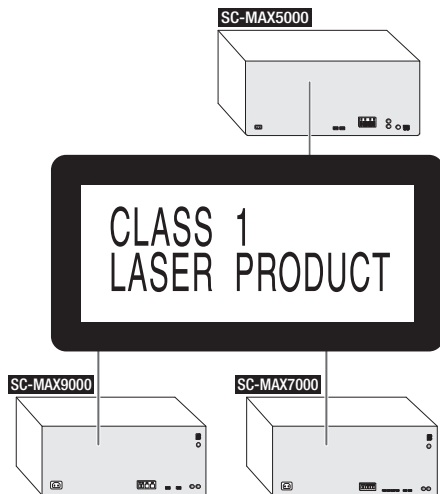

Recording and playback of content on this or any other devices may require permission from the owner of the copyright or other such rights of that content. Panasonic has no authority to and does not grant you that permission and explicitly disclaims any right, ability or intention to obtain such permission on your behalf. It is your responsibility to ensure that your use of this or any other devices complies with applicable copyright legislation in your country. Please refer to that legislation for more information on the relevant laws and regulations involved or contact the owner of the rights of the content you wish to record or playback.

**For Australia and New Zealand**



**Disposal of Old Equipment and Batteries Only for European Union and countries with recycling systems**

This symbol is only valid in the European Union.

If you wish to discard this product, please contact your local authorities or dealer and ask for the correct method of disposal.



## Safety precautions

### WARNING!

#### Unit

- To reduce the risk of fire, electric shock or product damage,
  - Do not expose this unit to rain, moisture, dripping or splashing.
  - Do not place objects filled with liquids, such as vases, on this unit.
  - Use only the recommended accessories.
  - Do not remove covers.
  - Do not repair this unit by yourself. Refer servicing to qualified service personnel.
  - Do not let metal objects fall inside this unit.

### CAUTION!

#### Unit

- To reduce the risk of fire, electric shock or product damage,
  - Do not install or place this unit in a bookcase, built-in cabinet or in another confined space. Ensure this unit is well ventilated.
  - Do not obstruct this unit's ventilation openings with newspapers, tablecloths, curtains, and similar items.
  - Do not place sources of naked flames, such as lighted candles, on this unit.
- This unit is intended for use in moderate climates.
- This unit may receive radio interference caused by mobile telephones during use. If such interference occurs, please increase separation between this unit and the mobile telephone.
- This unit utilizes a laser. Use of controls or adjustments or performance of procedures other than those specified herein may result in hazardous radiation exposure.
- Set the unit up on an even surface away from direct sunlight, high temperatures, high humidity, and excessive vibration.
- Do not stare directly at the illumination LED to avoid eyes discomfort.

#### AC Power supply cord

- The mains plug is the disconnecting device. Install this unit so that the mains plug can be unplugged from the socket outlet immediately.

#### Battery

- Danger of explosion if battery is incorrectly replaced. Replace only with the type recommended by the manufacturer.
- When disposing of the batteries, please contact your local authorities or dealer and ask for the correct method of disposal.
- Do not heat or expose to flame.
- Do not leave the battery(ies) in a car exposed to direct sunlight for a long period of time with doors and windows closed.
- Do not break open or short-circuit the battery.
- Do not charge the alkaline or manganese battery.
- Do not use the battery if the cover has peeled off.
- Remove the battery if you do not use the remote control for a long period of time. Keep in a cool, dark area.

**For Central America and the Caribbean**

Operation is subject to the following two conditions:  
(1) this device may not cause harmful interference, and  
(2) this device must accept any interference received,  
including interference that may cause undesired  
operation.

## About Bluetooth®

Panasonic bears no responsibility for data and/or information that can possibly be compromised during a wireless transmission.

### Frequency band

- This system uses the 2.4 GHz frequency band.

### Certification

- This system conforms to the frequency restrictions and has received certification based on frequency laws. Thus, a wireless permit is not necessary.
- The actions below are punishable by law:
  - Taking apart or modifying the main unit.
  - Removing specification indications.

### Restrictions of use

- Wireless transmission and/or usage with all Bluetooth® equipped devices is not guaranteed.
- All devices must conform to standards set by Bluetooth SIG, Inc.
- Depending on the specifications and settings of a device, it can fail to connect or some operations can be different.
- This system supports Bluetooth® security features. But depending on the operating environment and/or settings, this security is possibly not sufficient. Transmit data wirelessly to this system with caution.
- This system cannot transmit data to a Bluetooth® device.

### Range of use

- Use this device at a maximum range of 10 m.
- The range can decrease depending on the environment, obstacles or interference.

### Interference from other devices

- This system may not function properly and troubles such as noise and sound jumps may arise due to radio wave interference if this unit is located too close to other Bluetooth® devices or the devices that use the 2.4 GHz band.
- This system may not function properly if radio waves from a nearby broadcasting station, etc. is too strong.

### Intended usage

- This system is for normal, general use only.
- Do not use this system near an equipment or in an environment that is sensitive to radio frequency interference (example: airports, hospitals, laboratories, etc.).

## Table of contents

Safety precautions	2
References	3
Supplied accessories	4
Placement of speakers	4
Making the connections	6
Preparing the remote control	7
Overview of controls	8
Preparing media	10
Media playback	11
Radio	13
Recording	14
Sound and illumination effects	15
DJ functions	16
Using a microphone	17
Clock and timers	17
External equipment	18
Others	19
Maintenance	19
Troubleshooting	19
Specifications	21
Limited Warranty (Australia)	23

## References

### Licenses

The Bluetooth® word mark and logos are registered trademarks owned by Bluetooth SIG, Inc. and any use of such marks by Panasonic Corporation is under license. Other trademarks and trade names are those of their respective owners.

Google Play and Android are trademarks of Google Inc.

MPEG Layer-3 audio coding technology licensed from Fraunhofer IIS and Thomson.

# Supplied accessories

Check and identify the supplied accessories.

- 1 AC power supply cord
- 1 AM loop antenna
- 1 FM indoor antenna



- 1 Remote control (N2QAYB001022)
- 1 Remote control battery
- SC-MAX9000**  
8 Speaker feet
- SC-MAX9000** (Except for Australia and New Zealand)  
**SC-MAX7000**  
1 Power plug adapter

## **SC-MAX7000**

- 16 Speaker feet
- 16 Speaker stacking pins
- 2 Brackets
- 2 Screws

### CAUTION!

Keep the speaker feet, brackets and screws out of reach of children to prevent swallowing.

# Placement of speakers

Use only the supplied speakers.

You can cause damage to the system and decrease the sound quality if you use other speakers.

Note:

- Put the speakers on a flat safe surface.
- These speakers do not have magnetic shielding. Do not put them near TVs, PCs or other equipment easily influenced by magnetism.
- When you play at high levels for a long period, it can cause damage to the speakers and decrease the life of the speakers.
- Decrease the volume in these conditions to prevent damage:
  - When the sound is distorted.
  - When you adjust the sound quality.

### CAUTION!

- Use the speakers only with the recommended system. If not, you can cause damage to the amplifier and speakers and can cause a fire. Consult an approved service personnel if damage occurs or if there is a sudden apparent change in performance.
- Do not modify the speaker or speaker wires as this can cause damage to the system.
- Do the procedures included in these instructions when you attach the speakers.
- Do not touch the speaker cone's reverberating surfaces:
  - This may damage the speaker cone.
  - The speaker cone may be hot.

## **SC-MAX9000**

### Attaching the speaker feet

For stability and to prevent damage to the floor, attach the speaker feet to the bottom of the speakers.

#### Preparation

Put a protection layer below the speakers to prevent scratches.

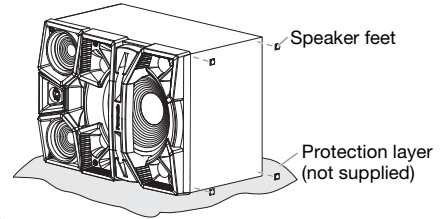

The left and right speakers are the same.

Keep your speakers more than 10 cm from the main unit to prevent vibration effects from speakers and for ventilation.

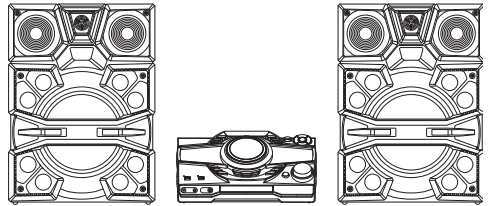

Note:

More than one person is required to move, tilt or carry the speakers.

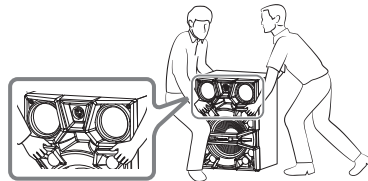

### CAUTION!

- Be careful when babies or children are near.
- Do not stack the speakers.
- Do not put a hand or foreign object into the port holes as this can cause personal injury and damage to the speaker.

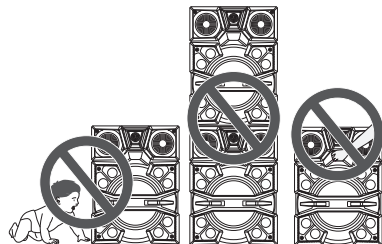

Put the speakers so that the tweeter is on the outside. Keep your speakers more than 10 mm from the main unit for ventilation.

**SC-MAX7000**

**Setup 1**

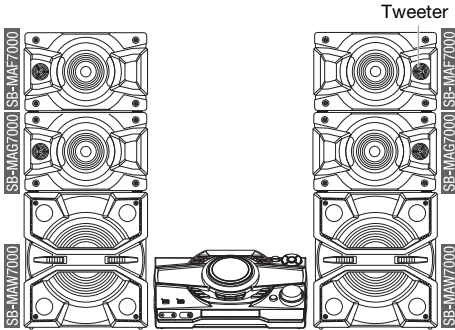

**Stacking the speakers**

Stack the speakers with the supplied speaker stacking pins. Press down the stacking pins and the speaker until it is secured in position.

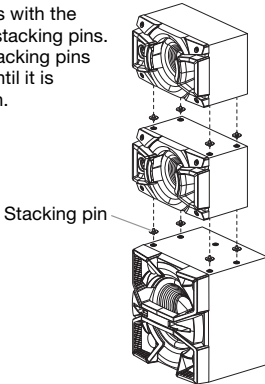

Install the supplied bracket as shown below to secure the speakers.

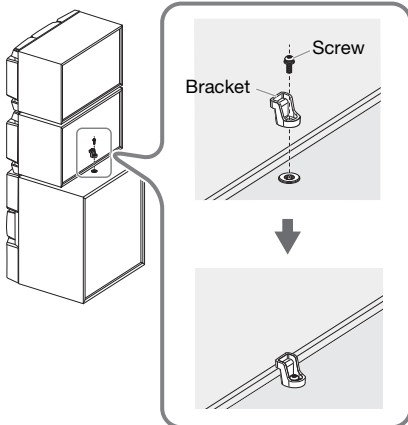

**Setup 2**

You can put the speakers in a vertical position as well as on a shelf.

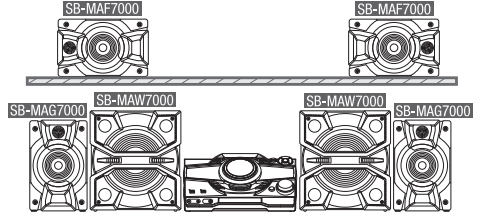

**Attaching the speaker feet**

Before placing the speakers (SB-MAF7000 & SB-MAG7000) in a vertical position, lay the speakers on top of a protection layer and paste the supplied speaker feet to the bottom of the speakers.

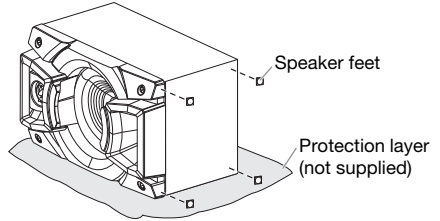

**SC-MAX5000**

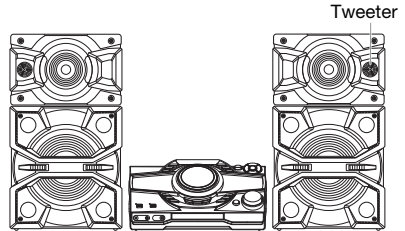

**Note:**

- More than one person is required to move, tilt or carry the speakers.

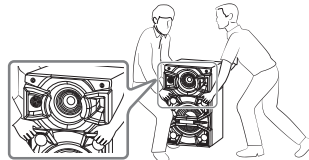

**CAUTION!**

- Be careful when babies or children are near.
- Do not stack the speakers.

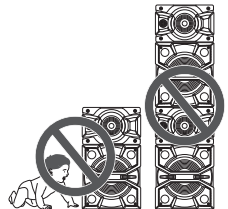

# Making the connections

Connect the AC power supply cord only after all the other connections have been made.

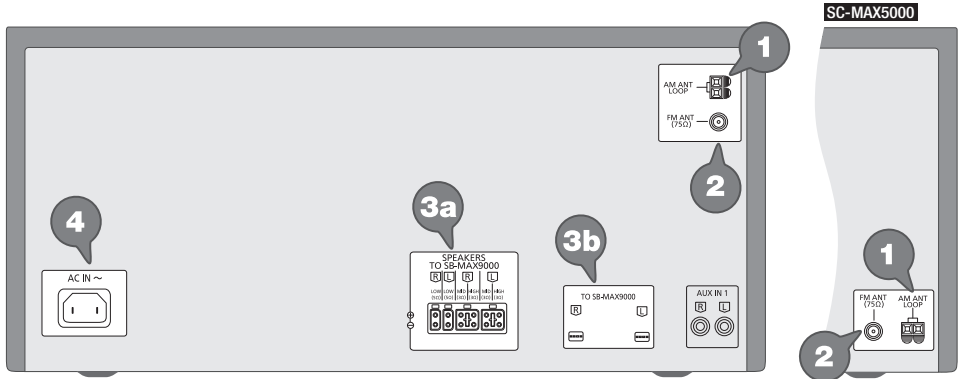

## 1 Connect the AM loop antenna.

Stand the antenna up on its base until it clicks.

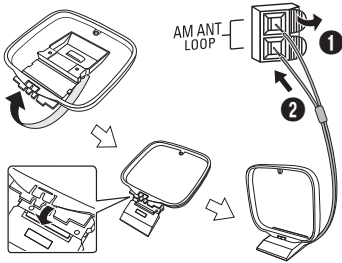

## 2 Connect the FM indoor antenna.

Put the antenna where reception is best.

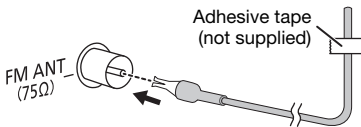

## 3 Connect the speakers.

Connect the speaker cables to the corresponding terminals.

SC-MAX9000

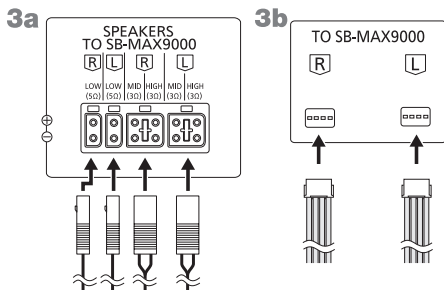

SC-MAX7000

## 3a

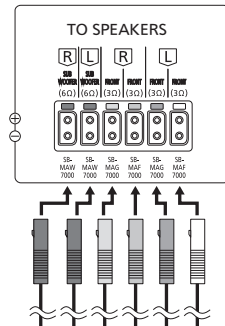

Connect the speaker cables to the terminals of the same color.

## 3b

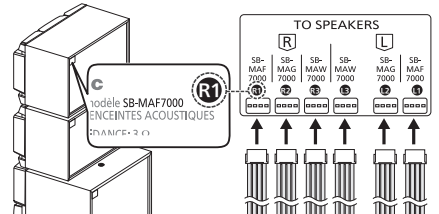

Connect the corresponding speaker lighting cables based on the speaker identification number.

3a

SPEAKERS  
TO SB-MAX5000

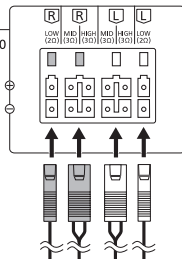

Connect the speaker cables to the terminals of the same color.

3b

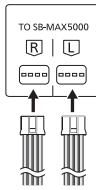

# Preparing the remote control

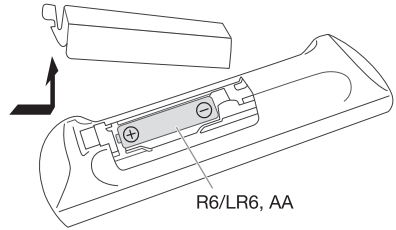

R6/LR6, AA

Use alkaline or manganese battery.

Install the battery so that the poles (+ and -) align with those in the remote control.

## 4 Connect the AC power supply cord.

Do not use any other AC power supply cords except the supplied one.

SC-MAX9000 SC-MAX7000

For Australia and New Zealand

For others

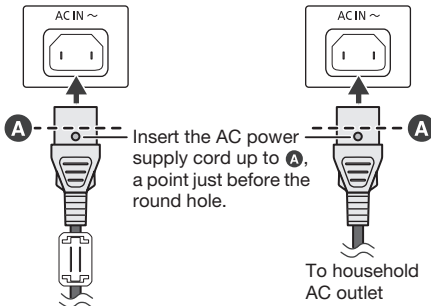

Insert the AC power supply cord up to **A**, a point just before the round hole.

To household AC outlet

To household AC outlet

Except for Australia and New Zealand

If the power plug does not fit your socket, use the supplied power plug adapter.

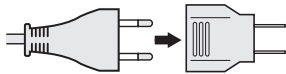

SC-MAX5000

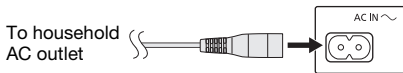

### Conserving power

The system consumes a small amount of power even when it is in standby mode. Disconnect the power supply if you do not use the system.

Some settings will be lost after you disconnect the system. You have to set them again.

# Overview of controls

Do the procedures with the remote control. You can also use the buttons on the main unit if they are the same.

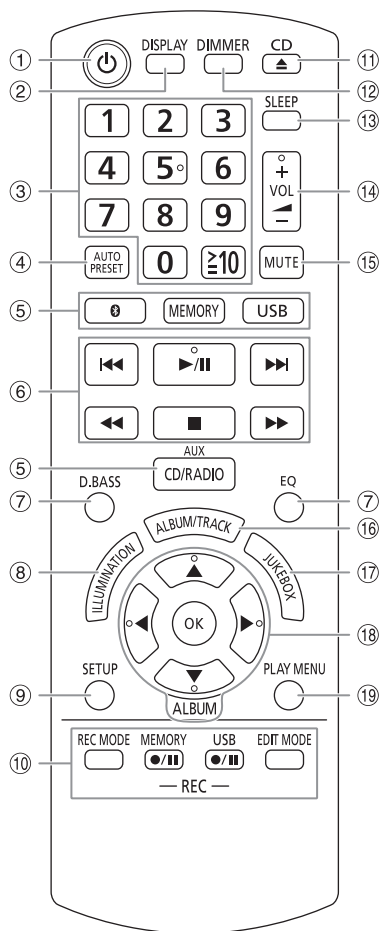

- ① **Standby/on switch** [⏻], [⏻]  
Press to switch the unit from on to standby mode or vice versa. In standby mode, the unit is still consuming a small amount of power.
- ② View the content information
- ③ **Numeric buttons**  
To select a 2-digit number  
Example: 16: [≥10] → [1] → [6]
- ④ Auto preset the radio station
- ⑤ **Select the audio source**  
On the main unit:  
To start Bluetooth® pairing, press and hold [Ⓜ-PAIRING].
- ⑥ Basic playback control
- ⑦ Select the sound effects
- ⑧ Select the illumination effects
- ⑨ View the setup menu
- ⑩ Recording operation control
- ⑪ Open or close the disc tray
- ⑫ **Decrease the brightness of the display panel**  
The illumination effect is also switched off.  
To cancel, press the button again.
- ⑬ Set the sleep timer
- ⑭ Adjust the volume level
- ⑮ **Mute the sound**  
To cancel, press the button again.  
“MUTE” is also canceled when you adjust the volume or when you switch off the system.
- ⑯ Select MP3 album or track
- ⑰ Select DJ jukebox
- ⑱ Select or confirm the option
- ⑲ View the play menu



## Top View

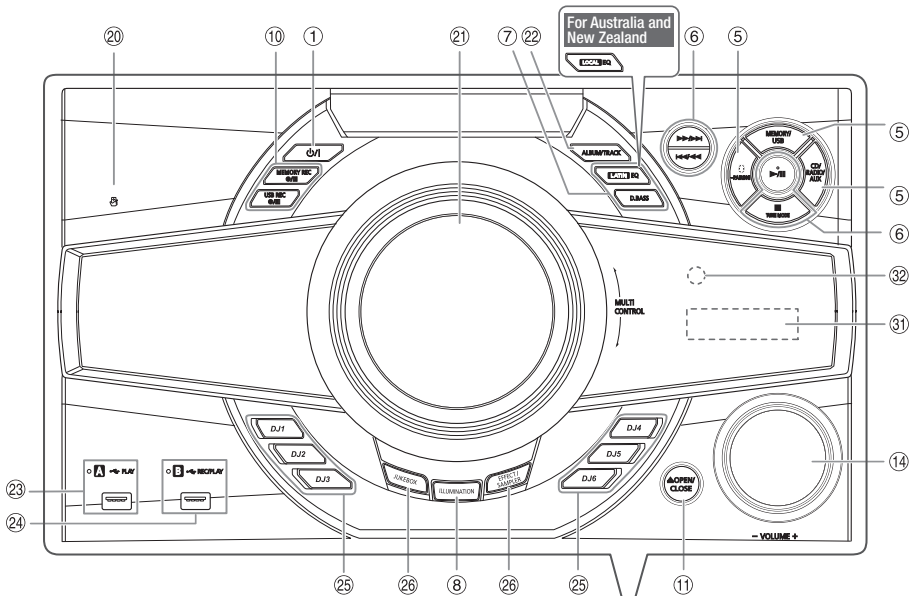

## Front View

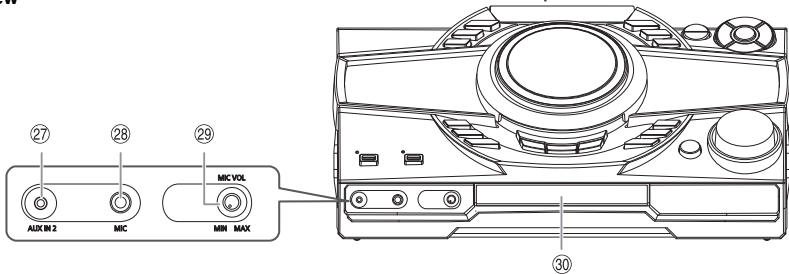

- 20 NFC touch area
- 21 Turntable for DJ and multi control
- 22 **Select MP3 album or track**  
Press [ALBUM/TRACK] to select album or track.  
**Browse tracks or albums**  
Turn [MULTI CONTROL] to browse.  
To start playback from the selection, press ▶/||.
- 23 **USB A**  
USB port (←) →  
USB status indicator  
Play MP3 tracks.
- 24 **USB B**  
USB port (←) →  
USB status indicator  
Play MP3 tracks.  
Record sound or music tracks.
- 25 **DJ function direct buttons**  
Press [JUKEBOX] or [EFFECT/SAMPLER] to switch on the DJ function.  
Press [DJ1] to [DJ6] on the main unit to select the desired function.  
To cancel, press the selected [DJ1] to [DJ6] again.

- 26 **Switch on the DJ function**  
To cancel, press the button again.
- 27 AUX IN 2 jack
- 28 Microphone jack
- 29 Adjust the microphone volume level

**CAUTION!**  
Keep the microphone volume knob out of reach of children to prevent swallowing.

- 30 Disc tray
- 31 Display panel
- 32 **Remote control sensor**  
Distance: Within approximately 7 m  
Angle: Approximately 20° up and down,  
30° left and right

# Preparing media

## Disc

- 1 Press [CD ▲] (main unit: [▲ OPEN/CLOSE]) to open the disc tray.

Put in a disc with the label facing up.  
Press again to close the disc tray.

- 2 Press [CD/RADIO/AUX] to select “CD”.

## USB

### Preparation

Before you connect a USB device to the system, make sure you do a backup of the data.

- 1 Decrease the volume and connect the USB device to the USB port.

Hold the main unit when connecting or disconnecting the USB device.

- 2 Press [USB] (main unit: [MEMORY/USB]) to select “USB A” or “USB B”.

USB status indicator lights up in red when selected.

### Note:

Do not use a USB extension cable. The system cannot recognise USB device connected through a cable.

## Bluetooth®

You can connect and play an audio device wirelessly through Bluetooth®.

### Preparation

- Switch on the Bluetooth® feature of the device and put the device near the system.
- Read the operating instructions of the device for details.

## Pairing a device

### Preparation

If this system is connected to a Bluetooth® device, disconnect it (⇒ “Disconnecting a device”).

- 1 Press [Ⓜ].  
If “PAIRING” is shown, continue with step 3.
- 2 Press [PLAY MENU] to select “PAIRING” and then press [OK].

- 3 Select “SC-MAX9000”, “SC-MAX7000” or “SC-MAX5000” from the Bluetooth® menu of the device.

If prompted for a passkey, input “0000”.

The device connects with this system automatically after pairing is complete.

The name of the connected device is shown for a few seconds.

## Using the main unit

- 1 Press and hold [Ⓜ -PAIRING] until “PAIRING” is shown.
- 2 Select “SC-MAX9000”, “SC-MAX7000” or “SC-MAX5000” from the Bluetooth® menu of the device.

### Note:

You can pair up to 8 devices with this system. If a 9th device is paired, the device that has not been used for the longest time will be replaced.

## Connecting a device

### Preparation

If this system is connected to a Bluetooth® device, disconnect it (⇒ “Disconnecting a device”).

- 1 Press [Ⓜ].  
“BLUETOOTH READY” is shown.
- 2 Select “SC-MAX9000”, “SC-MAX7000” or “SC-MAX5000” from the Bluetooth® menu of the device.  
The name of the connected device is shown for a few seconds.

- 3 Start playback on the device.

### Note:

- A device must be paired to connect.
- This system can only connect to one device at a time.
- When “BLUETOOTH” is selected as the source, this system will automatically try to connect to the last connected device. (“LINKING” is shown during this process.)

## Disconnecting a device

- 1 Press [Ⓜ].
- 2 Press [PLAY MENU] to select “DISCONNECT?”.
- 3 Press [◀, ▶] to select “OK? YES” and then press [OK].  
“BLUETOOTH READY” is shown.  
To cancel, select “OK? NO”.

## Using the main unit

Press and hold [Ⓜ -PAIRING] until “PAIRING” is shown.

### Note:

A device is disconnected when you:

- Select a different source.
- Move the device out of the maximum range.
- Disable the Bluetooth® transmission of the device.
- Switch off the system or the device.

## One-Touch Connection (NFC)

### For NFC-compatible Bluetooth® devices (Android™ devices) only

Simply by touching an NFC (Near Field Communication)-compatible Bluetooth® device on the system, you can complete all preparations, from registering a Bluetooth® device to establishing a connection.

Android device version lower than 4.1 requires the installation of the “Panasonic MAX Juke” app (free of charge).

- 1 Enter “Panasonic MAX Juke” in the search box of Google Play™ to search and then select “Panasonic MAX Juke”.
- 2 Start the app.
  - Follow the instructions to complete the settings.
  - Make sure to use the latest version of the app.

### Preparation

Switch on the NFC feature of the device.

- 1 Press [F].
- 2 Touch and hold the device on the NFC touch area of the main unit [G].

Bluetooth® device (not supplied)

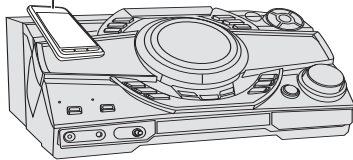

- Hold the device until it beeps, vibrates or displays a pop-up window, and then move the device away from the system.
- Once the registration and connection of the device is complete, the name of the connected device is shown on the system for a few seconds.
- When the connection is not established even if the device has touched the NFC touch area, change its touching position. The connection may improve if you use the “Panasonic MAX Juke” app.

### 3 Start playback on the device.

#### Note:

- While connected, you can connect another device by touching and holding it on the NFC touch area of the main unit. The previous device will be disconnected automatically.
- Depending on the device:
  - The one-touch connection may not work.
  - The position of the NFC touch area of the device may be different.
  - When the connection is established, playback may start automatically.

## Media playback

The following marks indicate the availability of the feature.

- CD**: CD-R/RW in CD-DA format or with MP3 files.
- USB**: USB device with MP3 files.
- BLUETOOTH**: Bluetooth® device.
- MEMORY**: Internal memory (refer to “Recording” for adding tracks to the internal memory).

## Basic playback

	CD	USB	BLUETOOTH	MEMORY
Play	Press [▶/  ].			
Stop	Press [■]. <b>USB</b> <b>MEMORY</b> The position is memorized. “RESUME” is shown. Press again to stop fully.			
Pause	Press [▶/  ]. Press again to continue playback.			
Skip	Press [◀◀] or [▶▶] (main unit: [◀◀/▶▶] or [▶▶/▶▶]) to skip track. <b>CD</b> <b>USB</b> <b>MEMORY</b> Press [▲, ▼] to skip MP3 album.			
Search	Press and hold [◀◀] or [▶▶] (main unit: [◀◀/▶▶] or [▶▶/▶▶]).			

#### Note:

Depending on the Bluetooth® device, some operations may not work.

## Viewing available information

**CD** **USB** **BLUETOOTH** **MEMORY**

You can view the available information, such as MP3 album and track number, on the display panel.

### Press [DISPLAY].

Example: MP3 album and track number display.

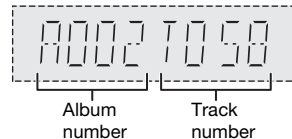

#### Note:

- Maximum characters that can be shown: Approximately 32
- This system supports ver. 1.0, 1.1 and 2.3 ID3 tags.
- Text data that the system does not support can show differently.

## Play menu

### CD USB MEMORY

- 1 Press [PLAY MENU].
- 2 Press [◀, ▶] to select the setting and then press [OK].

OFF PLAYMODE	Cancel the setting.
1-TRACK 1 🎵	Play one selected track. Press the numeric buttons to select the track.
1-ALBUM 1 📁	Play one selected MP3 album. Press [▲, ▼] to select the MP3 album.
RANDOM RND	Play all tracks randomly.
1-ALBUM RANDOM 1 📁 RND	Play all tracks in one selected MP3 album randomly. Press [▲, ▼] to select the MP3 album.
ALL REPEAT ⏮	Repeat all tracks.
1-TRACK REPEAT 1 🎵 ⏮	Repeat 1-TRACK.
1-ALBUM REPEAT 1 📁 ⏮	Repeat 1-ALBUM.
RANDOM REPEAT RND ⏮	Repeat random playback.
1-ALBUM RANDOM REPEAT 1 📁 RND ⏮	Repeat 1-ALBUM RANDOM.

#### Note:

- During random playback, you cannot skip to tracks which have been played.
- The setting is canceled when you open the disc tray or disconnect the USB device.

## Link mode

### BLUETOOTH

You can change the link mode to suit the connection type.

#### Preparation

If this system is connected to a Bluetooth® device, disconnect it (➡ “Disconnecting a device”).

- 1 Press [PLAY MENU] to select “LINK MODE”.
- 2 Press [◀, ▶] to select the mode and then press [OK].

MODE 1	Emphasis on connectivity.
MODE 2 (default)	Emphasis on sound quality.

#### Note:

- Depending on the device, the playback image and sound may not be synchronized. In this case, select “MODE 1”.
- Select “MODE 1” if the sound is interrupted.

## Note on disc

- This system can play CD-R/RW with CD-DA or MP3 format content.
- Before playback, finalize the disc on the device it was recorded on.
- Some CD-R/RW cannot be played because of the condition of the recording.

## Note on USB device

- This system does not guarantee connection with all USB devices.
- This system supports USB 2.0 full speed.
- This system can support USB devices of up to 32 GB.
- Only FAT 12/16/32 file system is supported.

## Note on MP3 file

- Files are defined as tracks and folders are defined as albums.
- Tracks must have the extension “.mp3” or “.MP3”.
- Tracks will not necessarily be played in the order you recorded them.
- Some files can fail to work because of the sector size.

### MP3 file on disc

- This system can access up to:
  - 255 albums (including root folder)
  - 999 tracks
  - 20 sessions
- Disc must conform to ISO9660 level 1 or 2 (except for extended formats).

### MP3 file on USB device

- This system can access up to:
  - 800 albums (including root folder)
  - 8000 tracks
  - 999 tracks in one album

# Radio

## Preparation

Press [CD/RADIO/AUX] to select "FM" or "AM".

## Manual tuning

Press [◀◀] or [▶▶] to tune in to the station.

To tune automatically, press and hold the button until the frequency starts changing quickly.

"STEREO" is shown when a stereo broadcast is being received.

### Using the main unit

- 1 Press [TUNE MODE] to select "MANUAL".
- 2 Press [◀◀/▶▶] or [▶▶/▶▶] to tune in to the station.

## Memory presetting

You can preset up to 30 FM and 15 AM stations.

### Automatic presetting

- 1 Press [AUTO PRESET] to select "LOWEST" or "CURRENT".

LOWEST	Tuning begins from the lowest frequency.
CURRENT	Tuning begins from the current frequency.

- 2 Press [OK] to start presetting.  
The tuner presets all the stations it can receive into the channels in ascending order.  
To cancel, press [■].

### Manual presetting

- 1 Press [◀◀] or [▶▶] (main unit: [◀◀/▶▶] or [▶▶/▶▶]) to tune in to the station.
- 2 Press [OK].
- 3 Press the numeric buttons to select a preset number.  
Do steps 1 through 3 again to preset more stations.  
The new station replaces any station that occupies the same preset number.

### Selecting a preset station

Press the numeric buttons, [◀◀] or [▶▶] to select the preset station.

#### Using the main unit

- 1 Press [TUNE MODE] to select "PRESET".
- 2 Press [◀◀/▶▶] or [▶▶/▶▶] to select the preset station.

## Improving the sound quality

### When "FM" is selected

- 1 Press [PLAY MENU] to select "FM MODE".
- 2 Press [◀, ▶] to select "MONO" and then press [OK].  
To cancel, select "STEREO".  
"MONO" is also canceled when you change the frequency.

#### To memorize the setting

Continue with step 2 of "Manual presetting".

### When "AM" is selected

- 1 Press [PLAY MENU] to select "B.PROOF".
- 2 Press [◀, ▶] to select the setting that provides the best reception and then press [OK].

## Checking the signal status

### When "FM" is selected

Press [DISPLAY].

FM - - - -	The FM signal is weak. The system is not tuned in to a station.
FM ST	The FM signal is in stereo.
FM MONO	"MONO" is selected as the "FM MODE". The FM signal is in monaural.

## AM/FM allocation setting

### By main unit only

Depending on your model and region (refer to "Tuner section" in "Specifications"), you can change your AM broadcasts allocated in 10 kHz steps or FM broadcasts allocated in 0.2 MHz steps.

- 1 Press [CD/RADIO/AUX] to select "FM" or "AM".
- 2 Press and hold [CD/RADIO/AUX].

After a few seconds, the display panel shows the current minimum radio frequency. Release the button when the minimum frequency changes.

- To go back to the initial setting, do the above steps again.
- Preset frequencies are erased after you change the setting.

# Recording

This system can record up to 800 folders (maximum 999 tracks in an album) or a total of 8000 tracks, depending on the available storage capacity of the internal memory or the USB device in **USB B**.

## To check storage space

In the stop mode, press **[DISPLAY]**.

Example: Remaining recording time of the internal memory.



- “UPDATE” is shown when the system is reading the device.
- “NO DEVICE” is shown if there is no USB device connected to **USB B**.

### Note:

- All recordings are in “.mp3” format.
- You cannot do recording when you are using random playback mode.
- The DJ function is switched off during recording.
- Repeat playback mode is canceled during recording.
- A new album is added each time you do a recording.
- The sequence of album may change after the recording.
- The recordings are kept in a folder named “REC\_DATA” in the USB device or the internal memory.
- USB status indicator blinks in red during USB recording.

## Basic recording

### 1 Select the source you want to record.

#### CD-DA

Prepare the disc playback mode.

Record all tracks	Select “OFF PLAYMODE” (⇒ “Play menu”).
Record a specified track	Select “1-TRACK” (⇒ “Play menu”).

Make sure the disc is stopped.

#### Radio

Tune in to the radio station.

#### External equipment

Connect and play the equipment (⇒ “External equipment”).

### 2 Press **[MEMORY REC ●/II]** or **[USB REC ●/II]** to start recording.

The name of the folder that keeps the recording is shown.

Stop recording	Press <b>[■]</b> . “WRITING” is shown.
Pause recording	Press <b>[MEMORY REC ●/II]</b> or <b>[USB REC ●/II]</b> during recording. Press again to continue recording.  <b>Note:</b> You can pause during recording from the radio, AUX 1 or AUX 2 (except in “SYNCHRO” mode). A track mark is added every time you pause (⇒ “Adding track marks”).

### Note:

- Wait for a few seconds for the system to prepare the USB device before you start recording.
- When the next track of the disc is being recorded, it will be shown on the display.

## High-speed recording

### CD-DA disc recording speed:

CD, CD-R: Three times (3x) the normal speed.

CD-RW: Two times (2x) the normal speed.

### 1 Put in the disc you want to record.

### 2 Press **[REC MODE]** to select “NORMAL” or “HI-SPEED” and then press **[OK]**.

### 3 Press **[USB REC ●/II]** or **[MEMORY REC ●/II]** to start recording.

### Note:

- If you cannot record at high-speed because of the condition of the disc, record at normal speed.
- The sound is muted during high-speed recording.

## Adding track marks

When recording from radio or external equipment, you can divide tracks using various modes.

### Before recording

Press **[REC MODE]** to select the mode.

MANUAL	Add a track mark manually. Press <b>[OK]</b> during recording to add a track mark.
SYNCHRO (For AUX 1 or AUX 2 source)	Recording starts automatically when the other equipment starts to play. Recording pauses when it detects silence for 3 seconds.
TIME MARK	A track is automatically divided at 5-minute intervals.

### Note:

- During recording, if you press **[OK]** or pause recording while using “TIME MARK” mode, the 5-minute counter is reset.
- You cannot add track marks manually in “SYNCHRO” mode.

## Recording MP3 tracks

You can record MP3 tracks from:

- MP3 disc to **USB B** or internal memory
- **USB A** to **USB B** or internal memory
- **USB B** to internal memory or vice versa

### 1 Prepare the source you want to record.

Record all tracks	Select "OFF PLAYMODE" (→ "Play menu").
Record a specified album or track	Select "1-ALBUM" or "1-TRACK" (→ "Play menu").

### 2 Press **[MEMORY REC ●/II]** or **[USB REC ●/II]** to start recording.

To check the recording progress, press **[DISPLAY]**.

Stop recording	Press <b>[■]</b> . Recording stops at the last fully recorded track in the album. For example, if you stop recording during the fourth track, only the first three tracks are recorded. "NO FILE RECORDED" is shown if no track is recorded.
----------------	--

Note:

- Some tracks can use a longer time to record.
- Some tracks cannot be recorded because of the condition of the source.
- The recorded file name is the same as the original file (maximum 32 characters).

## Deleting the recorded tracks

- 1 **MEMORY**  
Press **[MEMORY]** (main unit: **[MEMORY/USB]**) to select "MEMORY".  
**USB B**  
Press **[USB]** (main unit: **[MEMORY/USB]**) to select "USB B".

### 2 Press **[▲, ▼]** to select the album.

### 3 Press **[◀◀]** or **[▶▶]** to select the track.

### 4 Press **[EDIT MODE]** to select the mode.

TRACK DEL	Delete a single track.
ALBUM DEL	Delete one album (maximum 999 tracks).
FORMAT	Format the USB device.
ALL DEL	Delete all albums in the internal memory.

- 5 Press **[OK]**.  
The selected item to be deleted is shown.
- 6 Press **[OK]**.  
"SURE? NO" is shown.
- 7 Press **[◀, ▶]** to select "SURE? YES" and then press **[OK]**.  
"WRITING" is shown.  
To cancel, select "SURE? NO".

## Sound and illumination effects

### Sound effects

#### Preset EQ

- 1 Press **[EQ]** (main unit: **[LATIN EQ]** or **[LOCAL EQ]**) to select "PRESET EQ".
- 2 Press **[▲, ▼]** to select the desired preset EQ setting and then press **[OK]**.  
Or turn **[MULTI CONTROL]** to select the desired preset EQ setting.

#### Manual EQ

- 1 Press **[EQ]** (main unit: **[LATIN EQ]** or **[LOCAL EQ]**) to select "MANUAL EQ".
- 2 Press **[▲, ▼]** to select the sound effect.  
Or turn **[MULTI CONTROL]** to select the sound effect.
- 3 Press **[◀, ▶]** to select the setting and then press **[OK]**.  
Or press **[◀◀/▶▶]** or **[▶▶/▶▶]** to select the setting.

BASS/MID/TREBLE	-4 to +4
SURROUND	"ON SURROUND" or "OFF SURROUND"

#### D.Bass

- 1 Press **[D.BASS]** to select "D.BASS LEVEL" or "D.BASS BEAT".  
To cancel, select "OFF D.BASS".
- 2 Press **[▲, ▼]** to select the setting and then press **[OK]**.  
Or turn **[MULTI CONTROL]** to select the setting.

Note:

D.BASS BEAT: This function emphasizes the attack level of the drum beat and produces a punchy sound. Depending on the track, the effect may be small.

### Illumination effects

You can change the illumination effect on the system.

Press **[ILLUMINATION]** to select the desired effect.

PATTERN	Illuminate with pattern in multiple colors.
COLOR	A selection of 60 different illumination colors on the speakers and 6 different illumination colors on the main unit.
OFF	Cancel the effect.

You can also press **[▲, ▼]** to select the next or previous effect and then press **[OK]**.  
Or turn **[MULTI CONTROL]** to select the effect.

Note:

#### SC-MAX7000

To ensure the illumination effects are shown properly, make sure to arrange the speakers accordingly as in "Placement of speakers".

# DJ functions

You can use the DJ functions to add sound effect or sample sound between songs.

## Using the “Panasonic MAX Juke” app

You can download and install the free Android app “Panasonic MAX Juke” on Google Play for additional features, such as to request song playback from multiple devices simultaneously. For details on the app, refer to the below site. [http://av.jp.support.panasonic.com/support/global/cs/audio/app/max\\_juke/android/index.html](http://av.jp.support.panasonic.com/support/global/cs/audio/app/max_juke/android/index.html) (This site is in English only.)

### Note:

The DJ function is switched off when you switch off the system, change to another source or during recording.

## DJ jukebox

### USB MEMORY

You can use the DJ jukebox function to add cross-fade effect or sample sound mix between songs.

Press **[JUKEBOX]** to select “JUKEBOX”. To cancel, select “OFF JUKEBOX”.

### Note:

The system switches to repeat mode automatically when you switch on DJ Jukebox.

## Changing the repeat setting

- 1 Press **[PLAY MENU]**.
- 2 Press **[◀, ▶]** to select the setting and then press **[OK]**.

### Using the main unit

In the stop mode, turn **[MULTI CONTROL]** to select the setting and then press **[▶/II]**.

RANDOM REPEAT RND	Repeat random playback.
ALL TITLE REPEAT 	Repeat all tracks.
RANDOM MIX REPEAT RND	Repeat random playback. Sample sound is added to the intervals of all tracks.

## Changing the DJ jukebox effect

Press **[DJ1]** to **[DJ6]** on the main unit to select the effect.

[DJ1]	<i>Cross-fade</i> : The current track volume gradually becomes soft, and the next track volume gradually becomes loud.
[DJ2] to [DJ6]	<i>Sample sound mix</i> : Sample sound is added to the intervals of all tracks.

To cancel, press the button again.

### Note:

You cannot select the DJ jukebox effect when you are using “RANDOM MIX REPEAT” mode.

## Using the “Panasonic MAX Juke” app

You can call up the tracks you want to play through the app.

## DJ sampler

(Except for AUX 1 and AUX 2 source)

### By main unit only

By turning **[MULTI CONTROL]**, you can apply a scratch sound or sample sound to the track you are playing.

- 1 Press **[EFFECT/SAMPLER]** to select “SAMPLER SELECT NUMBER”.
- 2 Press **[DJ1]** to **[DJ6]** to select the desired sound.
- 3 Turn **[MULTI CONTROL]**.

### To cancel DJ sampler

Press **[EFFECT/SAMPLER]** to select “OFF EFFECT”.

## Using the “Panasonic MAX Juke” app

You can change the sample sound on the app. (To return all sample sounds to the factory preset, press and hold **[EFFECT/SAMPLER]** when the DJ sampler is switched off.)

## DJ effect

(Except for AUX 1 and AUX 2 source)

### By main unit only

You can use the DJ effect function to add the sound effects.

- 1 Press **[EFFECT/SAMPLER]** to select “DJ EFFECT SELECT NUMBER”.
- 2 Press **[DJ1]** to **[DJ6]** to select the effect.

[DJ1] PHASER	Add space and dimension to the sound.
[DJ2] FILTER	Enhance or filter specific ranges of the sound.
[DJ3] SOUND CHOPPER	Cut off the sound periodically.
[DJ4] ELECTRO ECHO	Add digital echo to the sound.
[DJ5] PITCH SHIFTER	Adjust the keys of the sound.
[DJ6] HARMONIZER	Add notes to the sound to create harmony.

- 3 Turn **[MULTI CONTROL]** to select the setting.

### To cancel DJ effect

Press **[EFFECT/SAMPLER]** to select “OFF EFFECT”.



# Using a microphone

## Preparation

Decrease the volume of the system to its minimum before you connect or disconnect a microphone.

### 1 Connect a microphone (not supplied) to the microphone jack.

Plug type: Ø 6.3 mm monaural

### 2 Turn [MIC VOL, MIN/MAX] on the main unit to adjust the volume of the microphone.

If you want to sing with the background music.

### 3 Play the music source and adjust the volume of the system.

#### Note:

- If a strange noise (howling) is emitted, move the microphone away from the speakers, or decrease the volume of the microphone.
- When you do not use the microphone, disconnect it from the microphone jack, and decrease the volume of the microphone level to "MIN".
- This system cannot record from microphone.

# Clock and timers

## Setting the clock

**SC-MAX5000** (For Central America and the Caribbean)

This is a 12-hour clock.

**For others**

This is a 24-hour clock.

### 1 Press [SETUP] to select "CLOCK".

### 2 Press [◀, ▶] to set the time and then press [OK].

#### To check the time

Press [SETUP] to select "CLOCK" and then press [OK].

In standby mode, press [DISPLAY].

#### Note:

Reset the clock regularly to maintain accuracy.

## Sleep timer

The sleep timer switches off the system after the set time.

Press [SLEEP] to select the setting (in minutes).

To cancel, select "OFF".

SLEEP 30 → SLEEP 60 → SLEEP 90 → SLEEP 120  
← OFF →

#### To check the remaining time

Press [SLEEP].

#### Note:

- The remaining time is shown for a few seconds every minute. "SLEEP 1" is always shown when only 1 minute remains.
- The play timer and sleep timer or the record timer and sleep timer can be used together.
- The sleep timer always comes first. Be sure not to set an overlap of timers.

## Play timer and record timer

(Except for Bluetooth®, AUX 1 and AUX 2 source)

You can set the timer to come on at a certain time to:

- Wake you up (play timer).
- Record from the radio (record timer).

Play timer and record timer cannot be used together.

## Preparation

Set the clock.

### 1 Press [SETUP] to select "TIMER ADJ".

### 2 Press [◀, ▶] to select "⊕PLAY" or "⊕REC" and then press [OK].

### 3 Press [◀, ▶] to set the start time and then press [OK].

### 4 Do step 3 again to set the end time.

### 5 Press [◀, ▶] to select the source you want to play or record and then press [OK].

### 6 For record timer, press [◀, ▶] to select "MEMORY" or "USB B" to keep the recording and then press [OK].

#### To start the timer

### 1 Prepare the source.

Play timer	Prepare the source you want to listen to (disc, USB, internal memory or radio) and set the volume.
Record timer	Connect the USB device to <b>USB B</b> (for USB recording) and tune in to the radio station.

### 2 Press [SETUP] to select "TIMER SET".

### 3 Press [◀, ▶] to select the setting and then press [OK].

PLAY ON	Start the play timer.
PLAY OFF	Cancel the play timer.
REC ON	Start the record timer.
REC OFF	Cancel the record timer.

"⊕" is shown.

The system must be switched off for the timer to operate.

#### To check the setting

### 1 Press [SETUP] to select "TIMER ADJ".

### 2 Press [◀, ▶] to select "⊕PLAY" or "⊕REC" and then press [OK].

In standby mode, press [DISPLAY] two times.

#### Note:

- The play timer starts at a low volume and increases gradually to the preset level.
- The record timer starts 30 seconds before the set time with the volume muted.
- The timer comes on at the set time every day if the timer is on.
- If you switch off the system and then switch on again while a timer is in operation, the timer will not stop at the end time.

# External equipment

## Preparation

- Disconnect the AC power supply cord.
- Switch off all equipment and read the appropriate operating instructions.

### Note:

Components and cables are sold separately.

## Using the auxiliary input

You can connect a VCR, DVD player etc. and listen to the audio through this system.

SC-MAX9000 SC-MAX7000

### Rear panel of this main unit

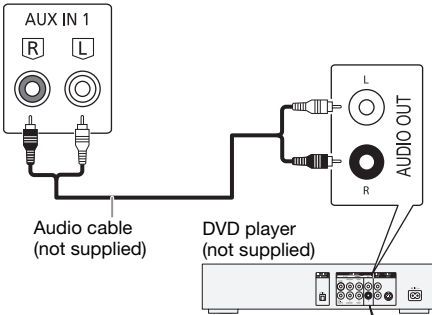

SC-MAX5000

### Rear panel of this main unit

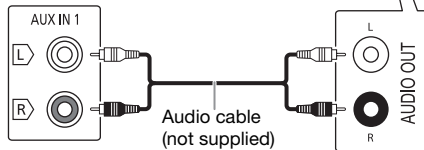

- 1 Connect the external equipment.**
- 2 Press [CD/RADIO/AUX] to select “AUX 1”.**
- 3 Play the external equipment.**

### Note:

- If you want to connect equipment other than those described, refer to the audio dealer.
- Sound distortion can occur when you use an adapter.

# Connecting a portable audio equipment

You can play music from a portable audio equipment.

## Preparation

- Switch off the equalizer (if any) of the portable audio equipment to prevent sound distortion.
- Decrease the volume of the system and the portable audio equipment before you connect or disconnect the portable audio equipment.

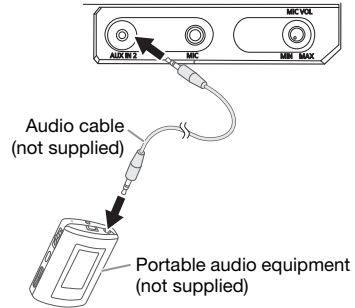

- 1 Connect the portable audio equipment.**  
Plug type:  $\varnothing$  3.5 mm stereo
- 2 Press [CD/RADIO/AUX] to select “AUX 2”.**
- 3 Play the portable audio equipment.**

### To adjust the input level

- 1 Press [PLAY MENU] to select “INPUT LEVEL”.**
- 2 Press [◀, ▶] to select “NORMAL” or “HIGH” and then press [OK].**

### Note:

- You cannot adjust the input level during recording.
- Select “NORMAL” if the sound is distorted during “HIGH” input level.
- Read the operating instructions of the portable audio equipment for details.

---

## Others

---

### Auto off

This system automatically switches off when you do not use it for approximately 20 minutes.

- 1 Press [SETUP] to select "AUTO OFF".
- 2 Press [◀, ▶] to select "ON" and then press [OK].  
To cancel, select "OFF".

#### Note:

This function does not work when you are in radio source or when a Bluetooth® device is connected.

---

### Bluetooth® standby

This function automatically switches on the system when you establish a Bluetooth® connection from a paired device.

- 1 Press [SETUP] to select "BLUETOOTH STANDBY".
- 2 Press [◀, ▶] to select "ON" and then press [OK].  
To cancel, select "OFF".

#### Note:

Some devices may take longer to respond. If you are connected to a Bluetooth® device before switching off the system, wait for a minimum of 5 seconds before connecting to this system from your Bluetooth® device again.

---

### Software version

You can check the software version of the system.

- 1 Press [SETUP] to select "SW VER." and then press [OK].  
The software version is shown.
  - 2 Press [OK] again to exit.
- 

## Maintenance

### To clean this system, wipe with a soft, dry cloth.

- Never use alcohol, paint thinner or benzene to clean this system.
- Before using chemically treated cloth, read the instructions that came with the cloth carefully.

---

## Troubleshooting

Before requesting service, make the following checks. If you are in doubt about some of the check points, or if the solutions indicated do not solve the problem, consult your dealer for instructions.

### Common problems

#### The unit does not work.

- The safety device has been activated. Do the following:
  1. Press [⏻] on the main unit to switch the unit to standby mode. If the unit does not switch to standby mode,
    - Press and hold the button for a minimum of 10 seconds. Or,
    - Disconnect the AC power supply cord and then connect it again.
  2. Press [⏻] again to switch on the unit. If the problem persists, consult your dealer.

#### The display panel lights up and changes continuously in standby mode.

- Press and hold [■] on the main unit to select "DEMO OFF".

#### No operations can be done with the remote control.

- Examine that the battery is installed correctly.

#### Sound is distorted or no sound.

- Adjust the volume of the system.
- Switch off the system, determine and correct the cause, and then switch on again. It can be caused by straining of the speakers through excessive volume or power, and when using the system in a hot environment.

#### A humming sound can be heard during playback.

- An AC power supply cord or fluorescent light is near the cables. Keep other appliances and cords away from the cables of this system.

#### The sound level reduces.

- The protection circuit has been activated due to the continuous use at high volume output. This is to protect the system and maintain the sound quality.

### Disc

#### Display not shown correctly.

#### Playback does not start.

- You have not put in the disc correctly. Put it in correctly.
- Disc is dirty. Clean the disc.
- Replace the disc if it is scratched, warped, or non-standard.
- There is condensation. Let the system dry for 1 to 2 hours.

#### The total number of tracks displayed is incorrect.

#### The disc cannot be read.

#### Distorted sound is heard.

- You put in a disc that the system cannot play. Change to a playable disc.
- You put in a disc that has not been finalized.

### USB

#### The USB device or the contents in it cannot be read.

- The format of the USB device or the contents in it are not compatible with the system.
- USB devices with storage capacity of more than 32 GB cannot work in some conditions.

#### Slow operation of the USB device.

- Large content size or large memory USB device takes longer time to read.

## Bluetooth®

### Pairing cannot be done.

- Check the Bluetooth® device condition.
- The device is out of the 10 m communication range. Move the device nearer to the system.

### The device cannot be connected.

- The pairing of the device was unsuccessful. Do pairing again.
- The pairing of the device has been replaced. Do pairing again.
- This system might be connected to a different device. Disconnect the other device and try pairing the device again.
- The system may have a problem. Switch off the system and then switch on again.

### The device is connected but audio cannot be heard through the system.

- For some built-in Bluetooth® devices, you have to set the audio output to "SC-MAX9000", "SC-MAX7000" or "SC-MAX5000" manually. Read the operating instructions of the device for details.

### Sound from the device is interrupted.

- The device is out of the 10 m communication range. Move the device nearer to the system.
- Remove any obstacle between the system and the device.
- Other devices that use the 2.4 GHz frequency band (wireless router, microwaves, cordless phones, etc.) are interfering. Move the device nearer to the system and distance it from the other devices.
- Select "MODE 1" for stable communication.

### The one-touch connection (NFC) is not working.

- Make sure the system and the NFC feature of the device are switched on.
- Touch and hold the device on the NFC touch area of this system again.

### Playback image and sound are not synchronized.

- Restart the playback app of the device
- Connect the device to the system with an audio cable (not supplied).

## Radio

### Sound is distorted.

- Use an optional FM outdoor antenna. The antenna should be installed by a competent technician.

### A beat sound is heard.

- Switch off the TV or move it away from the system.
- Move mobile telephones away from the system if the interference is apparent.
- When in AM tuner mode, select the "B.PROOF" setting that provides the best reception.

### A low hum is heard during AM broadcasts.

- Move the antenna away from other cables and cords.

## Main unit displays

### "ADJUST CLOCK"

- The clock is not set. Adjust the clock.

### "ADJUST TIMER"

- The play timer and/or record timer is not set. Adjust the play timer and/or record timer.

### "ALB FULL"

- The number of albums has exceeded the supported limit.

### "AUTO OFF"

- The system has not been used for 20 minutes and will switch off within a minute. To cancel, press any button.

### "CAN'T REC"

#### "DEVICE FULL"

- You cannot do recording because the remaining recording time of the USB device is less than the total time of the music source. Change to a USB device which has enough recording time and do the recording again.

### "ERROR"

- An incorrect operation was done. Read the instructions and try again.

### "ERROR" (during recording)

- You cannot select other playback source (example: radio, USB etc.) or press [◀◀] or [▶▶] during recording. Stop the recording function.
- You cannot open the disc tray when recording from an AM source.

### "F61"

- Examine and correct the speaker cords connection.
- Disconnect the USB device. Switch off the system and then switch on again.

### "F703"

- Examine the Bluetooth® connection.
- Disconnect the Bluetooth® device. Switch off the system and then switch on again.

### "F76"

- There is a problem with the power supply.
- Disconnect the AC power supply cord and consult your dealer.

### "F77"

- Disconnect the AC power supply cord and consult your dealer.

### "NO DEVICE"

- You cannot do recording or check available storage space because there is no USB device connected to **USB B**.

### "NO DISC"

- You have not put in a disc.

### "NO PLAY"

#### "UNSUPPORT"

- Examine the content. You can only play supported format.
- The files in the USB device can be corrupted. Format the USB device and try again.
- The system may have a problem. Switch off the system and then switch on again.

### "NO TRACK"

- There is no album or track in the USB device or the internal memory.

### "PLAYERERROR"

- An unsupported MP3 file has been played. The system will skip that track and play the next one.

### "REC ERROR"

- You disconnected the USB device during recording. Connect the USB device and do recording again.
- An error occurred during USB recording. Disconnect the USB device and then connect it again.

### "REMOTE 1"

#### "REMOTE 2"

- The remote control and the main unit are using different codes. Change the code of the remote control.
  - When "REMOTE 1" is shown, press and hold [OK] and [1] for a minimum of 4 seconds.
  - When "REMOTE 2" is shown, press and hold [OK] and [2] for a minimum of 4 seconds.

# Specifications

## Amplifier section

### RMS output power stereo mode

#### SC-MAX9000

High Ch	500 W per channel (3 Ω), 1 kHz, 30% THD
Mid Ch	500 W per channel (3 Ω), 1 kHz, 30% THD
Low Ch	1000 W per channel (5 Ω), 100 Hz, 30% THD
Total RMS stereo mode power	4000 W

#### SC-MAX7000

Front Ch	350 W per channel (3 Ω), 1 kHz, 30% THD
Front Ch	350 W per channel (3 Ω), 1 kHz, 30% THD
Subwoofer Ch	800 W per channel (6 Ω), 100 Hz, 30% THD
Total RMS stereo mode power	3000 W

#### SC-MAX5000

High Ch	350 W per channel (3 Ω), 1 kHz, 30% THD
Mid Ch	350 W per channel (3 Ω), 1 kHz, 30% THD
Low Ch	500 W per channel (2 Ω), 100 Hz, 30% THD
Total RMS stereo mode power	2400 W

## Tuner section

### SC-MAX9000 SC-MAX7000

#### Frequency modulation (FM)

Preset memory	30 stations
Frequency range	87.50 MHz to 108.00 MHz (50 kHz step)
Antenna terminals	75 Ω (unbalanced)

#### Amplitude modulation (AM)

Preset memory	15 stations
Frequency range	522 kHz to 1629 kHz (9 kHz step) 520 kHz to 1630 kHz (10 kHz step)

### SC-MAX5000

#### Frequency modulation (FM)

Preset memory	30 stations
Frequency range	87.50 MHz to 108.00 MHz (50 kHz step)

#### For Central America and the Caribbean

Frequency range	87.5 MHz to 108.0 MHz (100 kHz step) 87.9 MHz to 107.9 MHz (200 kHz step)
Antenna terminals	75 Ω (unbalanced)

#### Amplitude modulation (AM)

Preset memory	15 stations
Frequency range	522 kHz to 1629 kHz (9 kHz step) 520 kHz to 1630 kHz (10 kHz step)

#### For Central America and the Caribbean

Frequency range	520 kHz to 1710 kHz (10 kHz step)
-----------------	-----------------------------------

## Disc section

### Disc played (8 cm or 12 cm)

	CD, CD-R/RW (CD-DA, MP3*)
* MPEG-1 Layer 3, MPEG-2 Layer 3	

### Pick up

Wavelength	790 nm (CD)
------------	-------------

### “TEMP NG”

- The temperature protection circuit has been activated, and the system will switch off. Let the unit cool down before switching it on again.
- Check that the ventilation opening of the unit is not obstructed.
- Ensure this unit is well ventilated.

### “TRK FULL”

- The number of files has exceeded the supported limit.

### “USB A NO DEVICE”

### “USB B NO DEVICE”

- The USB device is not connected. Examine the connection.

### “USB OVER CURRENT ERROR”

- The USB device is using too much power. Disconnect the USB device, switch off the system and then switch on again.

### “VBR”

- The system cannot show the remaining play time for variable bit rate (VBR) tracks.

## Remote control code

When other Panasonic equipment responds to the remote control of this system, change the remote control code for this system.

### Preparation

Press [CD/RADIO/AUX] to select “AUX 1” or “AUX 2”.

## To set the code to “REMOTE 2”

- 1 Press and hold [CD/RADIO/AUX] on the main unit and [2] on the remote control until “REMOTE 2” is shown.
- 2 Press and hold [OK] and [2] for a minimum of 4 seconds.

## To set the code to “REMOTE 1”

- 1 Press and hold [CD/RADIO/AUX] on the main unit and [1] on the remote control until “REMOTE 1” is shown.
- 2 Press and hold [OK] and [1] for a minimum of 4 seconds.

## System memory reset

Reset the memory when the following situations occur:

- There is no response when buttons are pressed.
- You want to clear and reset the memory contents.

- 1 Disconnect the AC power supply cord.
- 2 While you press and hold [⏪] on the main unit, connect the AC power supply cord again. Continue to press and hold the button until “-----” is shown.

- 3 Release [⏪].

All the settings are set back to the factory preset. It is necessary to set the memory items again.

## Bluetooth® section

<b>Version</b>	Bluetooth® Ver. 2.1 + EDR
<b>Class</b>	Class 2
<b>Supported profiles</b>	A2DP, AVRCP, SPP, OPP, FTP
<b>Operating frequency</b>	2.4 GHz band FH-SS
<b>Operation distance</b>	10 m line of sight

## Internal memory section

### Memory

Memory size	4 GB
Media file format support	MP3 (*.mp3)

### Memory recording

Bit rate	128 kbps
Memory recording speed	1x, 3x max (CD only)
Recording file format	MP3 (*.mp3)

## Speaker section

### SB-MAX9000

#### Speaker unit(s)

Tweeter	6 cm cone type x 1
Woofer	16 cm cone type x 2
Super Woofer	38 cm cone type x 1

**Impedance** High 3 Ω / Mid 3 Ω / Low 5 Ω

#### Dimensions (W x H x D)

Including speaker feet	572 mm x 782 mm x 528 mm
Excluding speaker feet	572 mm x 774 mm x 528 mm

**Mass** 37 kg

### SB-MAF7000 SB-MAG7000

#### Speaker unit(s)

Tweeter	6 cm cone type
Woofer	20 cm cone type

**Impedance** 3 Ω

**Dimensions (W x H x D)** 407 mm x 260 mm x 258 mm

**Mass** 5.5 kg

### SB-MAW7000

#### Speaker unit(s)

Super Woofer	30 cm cone type
--------------	-----------------

**Impedance** 6 Ω

**Dimensions (W x H x D)** 402 mm x 450 mm x 386 mm

**Mass** 13 kg

### SB-MAX5000

#### Speaker unit(s)

Tweeter	6 cm cone type
Woofer	20 cm cone type
Super Woofer	30 cm cone type

**Impedance** High 3 Ω / Mid 3 Ω / Low 2 Ω

**Dimensions (W x H x D)** 407 mm x 709 mm x 389 mm

**Mass** 19 kg

## Terminal section

### USB port

USB standard	USB 2.0 full speed
Media file format support	MP3 (*.mp3)
USB device file system	FAT12, FAT16, FAT32

### USB recording

Bit rate	128 kbps
USB recording speed	1x, 3x (CD only)
Recording file format	MP3 (*.mp3)

### AUX IN 1

Audio input	Pin jack
-------------	----------

### AUX IN 2

Terminal	Stereo, 3.5 mm jack
----------	---------------------

### Microphone

Terminal	Mono, 6.3 mm jack
----------	-------------------

## General

### Power supply

#### SC-MAX9000 SC-MAX7000

For Australia and New Zealand AC 220 V to 240 V, 50 Hz

For others AC 110 V to 240 V, 50/60 Hz

#### SC-MAX5000

For South America AC 220 V to 240 V, 50/60 Hz

For Central America and the Caribbean AC 120 V, 60 Hz

### Power consumption

SC-MAX9000 SC-MAX7000 340 W

SC-MAX5000 240 W

**Dimensions (W x H x D)** 460 mm x 234 mm x 409 mm

### Mass

SC-MAX9000 SC-MAX7000 6.0 kg

SC-MAX5000 5.5 kg

**Operating temperature range** 0°C to +40°C

**Operating humidity range** 35% to 80% RH (no condensation)

### Power consumption in standby mode (approximate)

SC-MAX9000 SC-MAX7000 0.4 W

#### SC-MAX5000

For South America 0.5 W

For Central America and the Caribbean 0.4 W

### Power consumption in standby mode (approximate)

(With "BLUETOOTH STANDBY" set to "ON")

SC-MAX9000 SC-MAX7000 0.5 W

#### SC-MAX5000

For South America 0.6 W

For Central America and the Caribbean 0.5 W

### Note:

- Specifications are subject to change without notice. Mass and dimensions distortion are approximate.
- Total harmonic distortion is measured by the digital spectrum analyzer.

# Limited Warranty (Australia)

## Panasonic Warranty

1. The product is warranted for 12 months from the date of purchase. Subject to the conditions of this warranty Panasonic or its Authorised Service Centre will perform necessary service on the product without charge for parts or labour, if in the opinion of Panasonic, the product is found to be faulty within the warranty period.
2. This warranty only applies to Panasonic products purchased in Australia and sold by Panasonic Australia or its Authorised Distributors or Dealers and only where the products are used and serviced within Australia or its territories. Warranty cover only applies to service carried out by a Panasonic Authorised Service Centre and only if valid proof of purchase is presented when warranty service is requested.
3. This warranty only applies if the product has been installed and used in accordance with the manufacturer's recommendations (as noted in the operating instructions) under normal use and reasonable care (in the opinion of Panasonic). The warranty covers normal domestic use only and does not cover damage, malfunction or failure resulting from use of incorrect voltages, incorrect installation, accident, misuse, neglect, build-up of dirt or dust, abuse, maladjustment of customer controls, mains supply problems, thunderstorm activity, infestation by insects or vermin, tampering or repair by unauthorised persons (including unauthorised alterations), introduction of sand, humidity or liquids, commercial use such as hotel, office, restaurant, or other business or rental use of the product, exposure to abnormally corrosive conditions or any foreign object or matter having entered the product.
4. This warranty does not cover the following items unless the fault or defect existed at the time of purchase:
  - (a) Cabinet Part(s)
  - (b) Video or Audio Tapes
  - (c) SD cards or USB devices
  - (d) User replaceable Batteries
  - (e) DVD, Blu-ray or Recordable Discs
  - (f) Video / Audio Heads from wear and tear in normal use
  - (g) Information stored on Hard Disk Drive, USB stick or SD card
  - (h) DTV reception issues caused by TV Aerial / Cabling / Wall socket(s) etc
5. Some products may be supplied with Ethernet connection hardware. The warranty is limited on such products and will not cover
  - (a) Internet and or DLNA connection / setup related problems
  - (b) Access fees and or charges incurred for internet connection
  - (c) The use of incompatible software or software not specifically stipulated in the product operations manual; and
  - (d) Any indirect or consequential costs associated with the incorrect use or misuse of the hardware, its connection to the internet or any other device.
6. To claim warranty service, when required, you should:
  - Telephone Panasonic's Customer Care Centre on 132600 or visit our website referred to below and use the Service Centre Locator for the name / address of the nearest Authorised Service Centre.
  - Send or take the product to a Panasonic Authorised Service Centre together with your proof of purchase receipt as a proof of purchase date. Please note that freight and insurance to and / or from your nearest Authorised Service Centre must be arranged by you.
  - Note that home or pick-up / delivery service is available for the following products in the major metropolitan areas of Australia or the normal operating areas of the nearest Authorised Service Centres:
    - Plasma / LCD televisions / displays (screen size greater than 103 cm)
7. The warranties hereby conferred do not extend to, and exclude, any costs associated with the installation, de-installation or re-installation of a product, including costs related to the mounting, de-mounting or remounting of any screen, (and any other ancillary activities), delivery, handling, freighting, transportation or insurance of the product or any part thereof or replacement of and do not extend to, and exclude, any damage or loss occurring by reason of, during, associated with, or related to such installation, de-installation, re-installation or transit.

Panasonic Authorised Service Centres are located in major metropolitan areas and most regional centres of Australia, however, coverage will vary dependant on product. For advice on exact Authorised Service Centre locations for your product, please telephone our Customer Care Centre on 132600 or visit our website and use the Service Centre Locator.

In addition to your rights under this warranty, Panasonic products come with consumer guarantees that cannot be excluded under the Australian Consumer Law. If there is a major failure with the product, you can reject the product and elect to have a refund or to have the product replaced or if you wish you may elect to keep the goods and be compensated for the drop in value of the goods. You are also entitled to have the product repaired or replaced if the product fails to be of acceptable quality and the failure does not amount to a major failure.

If there is a major failure in regard to the product which cannot be remedied then you must notify us within a reasonable period by contacting the Panasonic Customer Care Centre. If the failure in the product is not a major failure then Panasonic may choose to repair or replace the product and will do so in a reasonable period of time from receiving notice from you.

**THIS WARRANTY CARD AND THE PURCHASE DOCKET (OR SIMILAR PROOF OF PURCHASE)  
SHOULD BE RETAINED BY THE CUSTOMER AT ALL TIMES**

If you require assistance regarding warranty conditions or any other enquiries, please visit the **Panasonic Australia** website [www.panasonic.com.au](http://www.panasonic.com.au) or contact by phone on **132 600**  
*If phoning in, please ensure you have your operating instructions available.*

**Panasonic Australia Pty. Limited**

ACN 001 592 187 ABN 83 001 592 187  
1 Innovation Road, Macquarie Park NSW 2113

## Customer Service (Latin America)

### Customer Service Directory

Obtain products information and operative assistant; localize the closer distributor or Service Center; buy spare parts and accessories by our Web Site to Latin American:

COUNTRY	WEB SITE	CONTACT CENTER
Panama	<a href="http://www.panasonic.com/pa/soporte/">www.panasonic.com/pa/soporte/</a>	800-7262
Colombia	<a href="http://www.panasonic.com/co/soporte/">www.panasonic.com/co/soporte/</a>	01-8000-947262
Ecuador	<a href="http://www.panasonic.com/ec/soporte/">www.panasonic.com/ec/soporte/</a>	1-800-726276
Costa Rica	<a href="http://www.panasonic.com/cr/soporte/">www.panasonic.com/cr/soporte/</a>	800-7262737
El Salvador	<a href="http://www.panasonic.com/sv/soporte/">www.panasonic.com/sv/soporte/</a>	800-7262
Guatemala	<a href="http://www.panasonic.com/gt/soporte/">www.panasonic.com/gt/soporte/</a>	1-801-811-7262
Uruguay	<a href="http://www.panasonic.com/uy/soporte/">www.panasonic.com/uy/soporte/</a>	0-800-7262
Paraguay	<a href="http://www.panasonic.com/uy/soporte/">www.panasonic.com/uy/soporte/</a>	0-800-11-7262
Chile	<a href="http://www.panasonic.com/cl/soporte/">www.panasonic.com/cl/soporte/</a>	800-390-602 022-797-5000
Peru	<a href="http://www.panasonic.com/pe/soporte/">www.panasonic.com/pe/soporte/</a>	0800-00726
Venezuela	<a href="http://www.panasonic.com/ve/soporte/">www.panasonic.com/ve/soporte/</a>	800-7262-800
Mexico	<a href="http://www.panasonic.com/mx/soporte/">www.panasonic.com/mx/soporte/</a>	01800-847-7262 55-5000-1200
Argentina	<a href="http://www.panasonic.com/ar/soporte/">www.panasonic.com/ar/soporte/</a>	0800-333-7262 0810-321-7262
Dominican Republic	<a href="http://www.panasonic.com/do/soporte/">www.panasonic.com/do/soporte/</a>	809-200-8000

Panasonic Corporation  
Web Site: <http://www.panasonic.com>

En