



# Operating Instructions

## Air Conditioner



**Model No.**

**Indoor Unit**

**CS-XV9UKD-3**

**CS-XV12UKD-3**

**Outdoor Unit**

**CU-XV9UKD-3**

**CU-XV12UKD-3**

### Operating Instructions Air Conditioner

Before operating the unit, please read these operating instructions thoroughly and keep them for future reference. The included Installation Instructions should be kept and read by the installer before installation. Remote control is packaged in the indoor unit and removed by the installer before installation.

English



**ACXF55-16960**

Provides fast cooling, maximum comfort and clean air.

**Human activity sensor**

- Area Search
- Activity Detection
- Absence Detection

Sunlight sensor and remote control receiver

**Econavi**

The intelligent human activity and sunlight sensors monitor human location, movements, absence and sunlight intensity.

See "To learn more..." for details.

Use remote control within 8 m from the remote control receiver of the indoor unit.

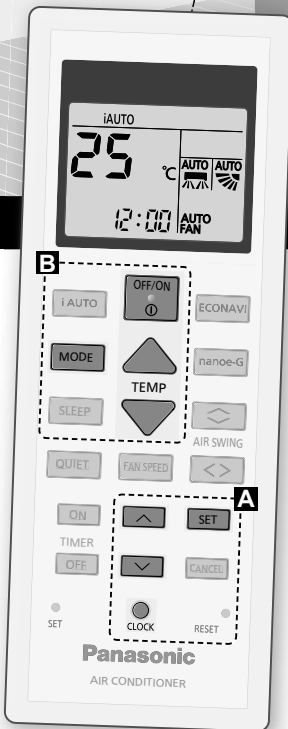

**Quick Guide**

**Inserting the batteries**

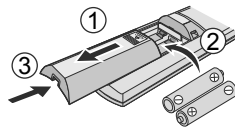

- 1 Pull out the back cover of remote control.
- 2 Insert AAA or R03 batteries.
- 3 Close the cover.

**Ⓐ Clock setting**



- 1 Press **CLOCK** and set the time **▲▼**.
  - Press **CLOCK** and hold for approximately 5 seconds to show time in 12-hour (am/pm) or 24 hour indication.
- 2 Confirm **SET**.

Thank you for purchasing  
Panasonic Air Conditioner.

## Table of contents

Safety precautions.....	4-5
How to use.....	6-7
To learn more... ..	8-9
Cleaning instructions.....	10
Troubleshooting.....	11-12
Information.....	Back cover

### Accessories

- Remote control
- AAA or R03 batteries × 2
- Remote control holder
- Screws for remote control holder × 2

The illustrations in this manual are for explanation purposes only and may differ from the actual unit. They are subject to change without notice for future improvement.

## B Basic operation

- ① Press **MODE** to select the desired mode.



- ② Press **OFF/ON** to start/stop the operation.

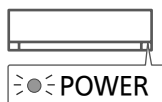

- Please note that the **OFF** indication is on display to start the unit.

- ③ Select the desired temperature.

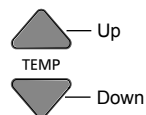



Selection range:  
16 °C ~ 30 °C /  
60 °F ~ 86 °F.

- Press and hold **▼** for approximately 10 seconds to switch the temperature indication in °C or °F.

# Safety precautions

To prevent personal injury, injury to others or property damage, please comply with the following:  
 Incorrect operation due to failure to follow instructions below may cause harm or damage, the seriousness of which is classified as below:  
 This appliances is not intended for accessibility by the general public.

	<b>WARNING</b>	This sign warns of death or serious injury.
---	----------------	---

	<b>CAUTION</b>	This sign warns of injury or damage to property.
---	----------------	--

The instructions to be followed are classified by the following symbols:

	This symbol denotes an action that is <b>PROHIBITED</b> .
---	---

	These symbols denote actions <b>COMPULSORY</b> .
---	--

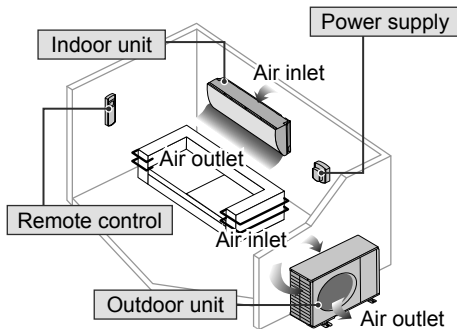

## **WARNING**

### Indoor unit and outdoor unit

 This appliance is not intended for use by persons (including children) with reduced physical, sensory or mental capabilities, or lack of experience and knowledge, unless they have been given supervision or instruction concerning use of the appliance by a person responsible for their safety. Children should be supervised to ensure that they do not play with the appliance.

Please consult authorised dealer or specialist to clean the internal parts, repair, install, remove and reinstall the unit. Improper installation and handling will cause leakage, electric shock or fire.

Confirm with authorised dealer or specialist on usage of any specified refrigerant type. Using refrigerant type other than the specified may cause product damage, burst and injury etc.

 Do not use means to accelerate the defrosting process or to clean, other than those recommended by manufacturer. Any unfit method or using incompatible material may cause product damage, burst and serious injury.

Do not install the unit in a potentially explosive or flammable atmosphere. Failure to do so could result in fire.

Do not insert your fingers or other objects into the air conditioner indoor or outdoor unit, rotating parts may cause injury. 

Do not touch the outdoor unit during lightning, it may cause electric shock.

Do not expose yourself directly to cold air for a long period to avoid excess cooling.

Do not sit or step on the unit, you may fall down accidentally. 

### Remote control

 Do not allow infants and small children to play with the remote control to prevent them from accidentally swallowing the batteries.

## Power supply



Do not use a modified cord, joint cord, extension cord or unspecified cord to prevent overheating and fire.



To prevent overheating, fire or electric shock:

- Do not share the same power outlet with other equipment.
- Do not operate with wet hands.
- Do not over bend the power supply cord.
- Do not operate or stop the unit by inserting or pulling out the power plug.



If the supply cord is damaged, it must be replaced by the manufacturer, service agent or similarly qualified persons in order to avoid a hazard.

It is strongly recommended to be installed with Earth Leakage Circuit Breaker (ELCB) or Residual Current Device (RCD) to prevent electric shock or fire.

To prevent overheating, fire or electric shock:

- Insert the power plug properly.
- Dust on the power plug should be periodically wiped with a dry cloth.

Stop using the product if any abnormality/failure occurs and disconnect the power plug or turn off the power switch and breaker.

(Risk of smoke/fire/electric shock)

Examples of abnormality/failure

- The ELCB trips frequently.
- Burning smell is observed.
- Abnormal noise or vibration of the unit is observed.
- Water leaks from the indoor unit.
- Power cord or plug becomes abnormally hot.
- Fan speed cannot be controlled.
- The unit stops running immediately even if it is switched on for operation.
- The fan does not stop even if the operation is stopped.

Contact your local dealer immediately for maintenance/repair.

Replacement or installation of power plugs shall be performed by authorised/qualified personnel only. The wires in this mains lead are coloured in accordance with the following code:

Terminals	wires	colours (GB Standard)
L	Red	live brown
N	Black	neutral blue
E	Green/Yellow	earth green-yellow

Wiring colour may vary depending on a country wiring code's standard.



This equipment must be earthed to prevent electrical shock or fire.



Prevent electric shock by switching off the power supply and unplug:

- Before cleaning or servicing,
- When extended non-use, or
- During abnormally strong lightning activity.



## CAUTION

### Indoor unit and outdoor unit



Do not wash the indoor unit with water, benzene, thinner or scouring powder to avoid damage or corrosion at the unit.

Do not use for preservation of precise equipment, food, animals, plants, artwork or other objects. This may cause quality deterioration, etc.

Do not use any combustible equipment in front of the airflow outlet to avoid fire propagation.

Do not expose plants or pet directly to airflow to avoid injury, etc.

Do not touch the sharp aluminium fin, sharp parts may cause injury.



Do not switch ON the indoor unit when waxing the floor. After waxing, aerate the room properly before operating the unit.

Do not install the unit in oily and smoky areas to prevent damage to the unit.

Do not dismantle the unit for cleaning purpose to avoid injury.

Do not step onto an unstable bench when cleaning the unit to avoid injury.

Do not place a vase or water container on the unit. Water may enter the unit and degrade the insulation. This may cause an electric shock.

Do not open window or door for long time during operation, it may lead to inefficient power usage and uncomfortable temperature changes.



Prevent water leakage by ensuring drainage pipe is:

- Connected properly,
- Kept clear of gutters and containers, or
- Not immersed in water

After a long period of use or use with any combustible equipment, aerate the room regularly.

After a long period of use, make sure the installation rack does not deteriorate to prevent the unit from falling down.

### Remote control



Do not use rechargeable (Ni-Cd) batteries. It may damage the remote control.



To prevent malfunction or damage of the remote control:

- Remove the batteries if the unit is not going to be used for a long period of time.
- New batteries of the same type must be inserted following the polarity stated.

### Power supply



Do not disconnect the plug by pulling the cord to prevent electric shock.

# How to use

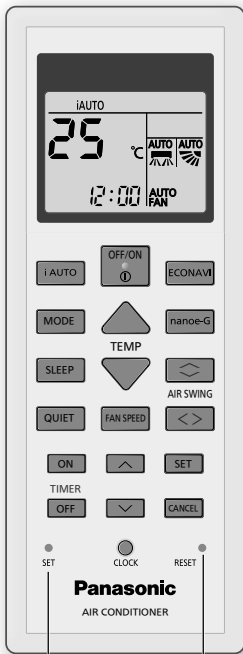
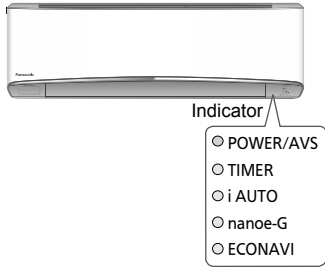

### To adjust airflow direction

Upper direction

AIR SWING

Lateral direction

- Do not adjust the flap by hand.

### To adjust fan speed

FAN SPEED

AUTO FAN

- For AUTO, the indoor fan speed is automatically adjusted according to the operation mode.
- If i AUTO mode is set, fan speed is fixed to AUTO. To adjust fan speed, cancel i AUTO mode.

### To enjoy quiet operation

QUIET

- This operation reduces airflow noise.

### To reach temperature quickly

i AUTO

i AUTO — Set temperature

Max = 4 hours

- The unit controls set temperature according to room temperature to accelerate room cooling.
- After max 4 hours, the set temperature follows the last set temperature setting.
- Fan speed is fixed at AUTO, fan speed selection is prohibited.
- During unit is off, press **i AUTO** will turn on the unit with i AUTO mode.
- i AUTO mode can be cancelled by pressing the respective button again.

### To save energy

ECONAVI

- When manual AIR SWING **<>** is selected, the ECONAVI operations will be cancelled.

### To maximise comfort while sleeping

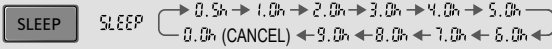

- This operation provides you with a comfortable environment while sleeping. It will automatically adjust the sleep pattern temperature during the activation period.
- The indoor unit indicator will dim when this operation is activated. This is not applicable if the indicator brightness has been manually dimmed.
- This operation is incorporated with the activation timer (0.5, 1, 2, 3, 4, 5, 6, 7, 8 or 9 hours).
- This operation can be set together with timer. Sleep operation has the priority over OFF timer.
- This operation can be cancelled by pressing the respective button when the sleep timer reaches 0.0h.

### To purify the air

nanoe-G

- nanoe-G starts automatically when the unit is turned on with .
- nanoe-G will not start automatically during ON timer if the unit has been turned off by .
- Can be activated even when the unit is turned off. In this condition, the unit will operate as a fan with AUTO fan speed and flap swing.

### To set the timer

To turn ON or OFF the unit at a preset time.

**1 Select ON or OFF timer**

**2 Set the time**

**3 Confirm**

Example:  
OFF at 22:00

- To cancel ON or OFF timer, press or then press .
- If timer is cancelled manually, you can restore the previous setting by pressing .
- If power failure, you can restore the timer again by pressing .
- Timer operation is based on the clock set in the remote control and repeats daily once set. For clock setting, please refer to Quick guide.

### Note

, ,

- Can be activated in all modes and can be cancelled by pressing the respective button again.

,

- Cannot be selected at the same time.

# To learn more...

## Operation mode

- i AUTO** : The fast cooling is ideal when you come home on a hot day.
- COOL** : Provides efficient comfort cooling to suit your needs.
- DRY** : Unit operates at low fan speed to give a gentle cooling operation.

## Energy saving temperature setting

Operating the unit within the recommended temperature range may save energy.

**COOL** : 26 °C ~ 28 °C / 79 °F ~ 82 °F.

## Air flow direction

**In i AUTO/COOL/DRY mode:**

If AUTO is set, the flaps swings left/right and up/down automatically.

If manual is set, the horizontal flap are fixed at the predetermined position.

## Automatic Voltage Switcher (AVS)

When power supply is unstable, where the AC voltage supplied is below 185 V or above 260 V, AVS will switch off the outdoor unit to protect the compressor. During this condition, the AVS indicator will turn on.

● POWER/AVS	Indicator	Indoor unit	Outdoor unit
	Green	ON	ON
	Orange	ON	OFF

## Auto restart control

If power is resumed after a power failure, the operation will restart automatically after a period of time with previous operation mode and airflow direction.

- This control is not applicable when TIMER is set.

## nanoe-G in-filter deactivation

Depending on the unit's accumulated operation time, nanoe-G in-filter deactivation may activate only once a day after the unit turned off.

To remove the moisture left in the internal parts, the fan will operate for 30 minutes with flap opened slightly. This process only applicable when the unit is operated in COOL/DRY mode before turned off. Then, nanoe-G deactivates viruses/bacteria on the filter for 2 hours with fan stopped and flap closed.

Do not turn off the power supply during this operation. After power failure, this operation will not resume.



## ECONAVI

### ■ Econavi with intelligent eco sensors

Intelligent eco sensors detect potential waste of energy using the human activity sensor and sunlight sensor.

**The human activity sensor** scans areas of heat source and movement in a room.

- Based on area activeness, flap will adjust its position automatically.
- The human activity sensor is influenced by the location of the indoor unit, the movement speed of human/non-human activity, temperature range, etc.
- The human activity sensor may mistakenly detect non-human activity and source of heat, such as pets, or may not detect the human activity or source of heat if the person stays motionless.
- Do not place large objects near the sensor and keep away heating units or humidifier from the sensor's detections area.

**The sunlight sensor** detects changes in sunlight intensity in the room. It reduces the waste of energy under less sunlight conditions.

### 4 Features

#### ① Area search

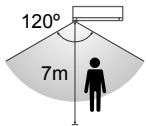

#### ② Activity detection

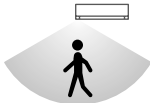

#### ③ Absence detection

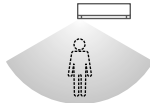

#### ④ Sunlight detection

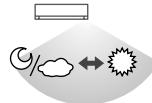

Human activity sensor detects presence/absence of human beings and the movement speed of human activities minimising the required amount of energy.

Adjusts power to changes in sunlight intensity.

## Operating conditions

Use this air conditioner in the temperature range indicated in the table.

Temperature °C (°F)		Indoor		Outdoor	
		DBT	WBT	DBT	WBT
COOL	Max.	32 (89.6)	23 (73.4)	46 (114.8)	26 (78.8)
	Min.	16 (60.8)	11 (51.8)	16 (60.8)	11 (51.8)

DBT : Dry bulb temperature, WBT : Wet bulb temperature

To learn more...

English

# Cleaning instructions

To ensure optimal performance of the unit, cleaning has to be carried out at regular intervals. Dirty unit may cause malfunction and you may see nanoe-G indicator blinks. Please consult authorised dealer.

- Switch off the power supply and unplug before cleaning.
- Do not touch the aluminium fin, sharp parts may cause injury.
- Do not use benzene, thinner or scouring powder.
- Use only soap (≈ pH 7) or neutral household detergent.
- Do not use water hotter than 40 °C / 104 °F.

## Indoor unit

Wipe the unit gently with a soft, dry cloth. Coils and fans should be clean for at least every 6 months by an authorised dealer.

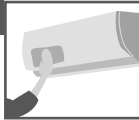

## Human activity sensor

Do not hit or violently press or poke it with a sharp object. This can lead to damage and malfunction.

## Outdoor unit

Clear debris that surround the unit. Clear any blockage from drain pipe.



## Front panel

Wash gently and dry.

### Remove the front panel

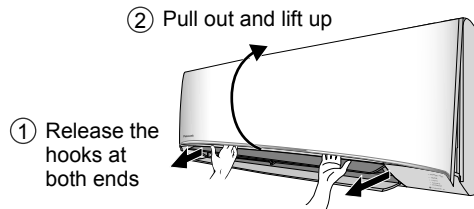

### Close it securely

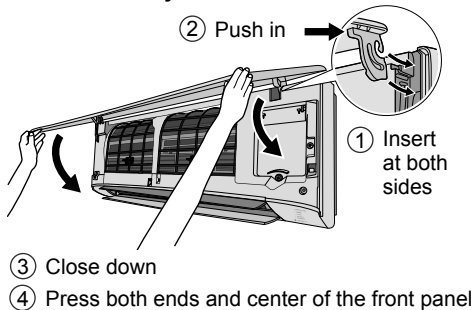

## Indoor unit

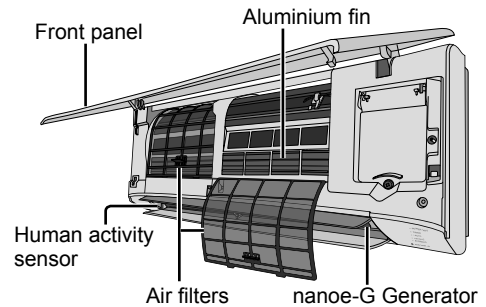

## nanoe-G Generator

Once every 2 weeks

- Clean with dry cotton bud.
- Do not touch during operation.

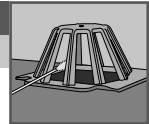

## Air filters

Once every 2 weeks

- Wash/rinse the filters gently with water to avoid damage to the filter surface.
- Dry the filters thoroughly under shade, away from fire or direct sunlight.
- Replace any damaged filters.



### Remove air filter

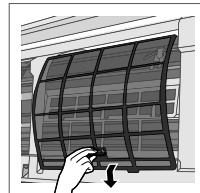

### Attach air filter

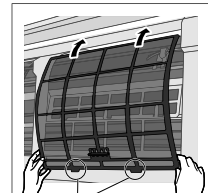

Insert into the unit

# Troubleshooting

The following symptoms do not indicate malfunction.

Symptom	Cause
POWER indicator blinks before the unit is switched on.	<ul style="list-style-type: none"> <li>• This is a preliminary step in preparation for the operation when the ON timer has been set.</li> <li>• When ON Timer is set, the unit may start earlier (up to 15 minutes) before the actual set time in order to achieve the desired temperature on time.</li> </ul>
TIMER indicator is always on.	<ul style="list-style-type: none"> <li>• The timer setting repeats daily once set.</li> </ul>
Operation is delayed a few minutes after restarting.	<ul style="list-style-type: none"> <li>• The delay is a protection to the unit's compressor.</li> </ul>
Indoor fan stops occasionally during automatic fan speed setting.	<ul style="list-style-type: none"> <li>• This helps to remove the surrounding odour.</li> </ul>
The room has a peculiar odour.	<ul style="list-style-type: none"> <li>• This may be due to damp smell emitted by the wall, carpet, furniture or clothing.</li> </ul>
Cracking sound during operation.	<ul style="list-style-type: none"> <li>• Changes of temperature caused the expansion/contraction of the unit.</li> </ul>
Water flowing sound during operation.	<ul style="list-style-type: none"> <li>• Refrigerant flow inside the unit.</li> </ul>
Mist emerges from indoor unit.	<ul style="list-style-type: none"> <li>• Condensation effect due to cooling process.</li> </ul>
Outdoor unit emits water/steam.	<ul style="list-style-type: none"> <li>• Condensation or evaporation occurs on pipes.</li> </ul>
Discoloration of some plastic parts.	<ul style="list-style-type: none"> <li>• Discoloration is subject to material types used in plastic parts, accelerated when exposed to heat, sun light, UV light or environmental factor.</li> </ul>
Dust may have collected around the front panel, grilles and wall surrounding the unit after extended use.	<ul style="list-style-type: none"> <li>• The dust accumulation is due to air purification effect of negative ions from nanoe-G. Remove the dust regularly with a clean dampened cloth.</li> </ul>

Check the following before calling for servicing.

Symptom	Check
Operation in COOL mode is not working efficiently.	<ul style="list-style-type: none"> <li>• Set the temperature correctly.</li> <li>• Close all doors and windows.</li> <li>• Clean or replace the filters.</li> <li>• Clear any obstruction at the air inlet and air outlet vents.</li> </ul>
Noisy during operation.	<ul style="list-style-type: none"> <li>• Check if the unit has been installed at an incline.</li> <li>• Close the front panel properly.</li> </ul>
Remote control does not work. (Display is dim or transmission signal is weak.)	<ul style="list-style-type: none"> <li>• Insert the batteries correctly.</li> <li>• Replace weak batteries.</li> </ul>
The unit does not work.	<ul style="list-style-type: none"> <li>• Check if the circuit breaker is tripped.</li> <li>• Check if timers have been set.</li> </ul>
The unit does not receive the signal from the remote control.	<ul style="list-style-type: none"> <li>• Make sure the receiver is not obstructed.</li> <li>• Certain fluorescent lights may interfere with signal transmitter. Please consult authorised dealer.</li> </ul>

# Troubleshooting

## When...

### ■The remote control is missing or a malfunction has occurred

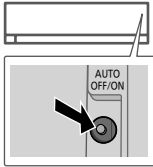

1. Raise the front panel.
2. Press the button once to use in i AUTO mode.
3. Press and hold the button until you hear 1 beep, then release to use in forced COOL mode.
4. Press the button again to turn off.

### ■The indicators are too bright

- To dim or restore the unit's indicator brightness, press  and hold for 5 seconds.

### ■Conducting a seasonal inspection after extended non-use

- Check the remote control batteries.
- Check that there is no obstruction around the air inlet and outlet vents.
- Use Auto OFF/ON button to select COOL operation. After 15 minutes of operation, it is normal to have the following temperature difference between the air inlet and outlet vents:

COOL:  $\geq 8^{\circ}\text{C} / 14.4^{\circ}\text{F}$

### ■The units are not going to be used for a long period of time

- Activate nanoe-G operation for 2~3 hours as an alternative to remove moisture left in the internal parts thoroughly to prevent mould growth.
- Turn off the power supply and unplug.
- Remove the remote control batteries.

### NON SERVICEABLE CRITERIAS

TURN OFF THE POWER SUPPLY AND UNPLUG then please consult an authorised dealer when in following conditions:

- Abnormal noise during operation.
- Water/foreign particles have entered the remote control.
- Water leaks from Indoor unit.
- Circuit breaker switches off frequently.
- Power cord becomes unnaturally warm.
- Switches or buttons are not functioning properly.
- The unit stops and the TIMER indicator blinks (insufficient refrigerant detected).

# Memo

---

Troubleshooting / Memo

English

# Memo

---

# Memo

---

# Information

## Information for Users on Collection and Disposal of Old Equipment and used Batteries



### [Information on Disposal in other Countries outside the European Union]

These symbols are only valid in the European Union. If you wish to discard these items, please contact your local authorities or dealer and ask for the correct method of disposal.

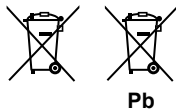

### Note for the battery symbol (bottom two symbol examples):

This symbol might be used in combination with a chemical symbol. In this case it complies with the requirement set by the Directive for the chemical involved.

## Panasonic Corporation

1006 Kadoma, Kadoma City,

Osaka, Japan

Website: <http://www.panasonic.com>

© Panasonic Corporation 2018

Printed in Malaysia

**ACXF55-16960**  
YA0118-0