

Operating & Installation Instructions

Fully Automatic Washing Machine
(Domestic use)

Model No. **NA-F150A3**



Contents

Safety Precautions	2
Part Names	3
Operation Panel	4
Variety of Programs	5
Detergent	6
Washing	7
Washing Options	8
• Blanket	
• Gentle Hand Wash	
• Air Dry	
• Wash / Rinse / Spin	
Convenient Functions	10
Maintenance	10
Installation	12
Troubleshooting	15
Error Display	16
Specifications	16

Thank you for purchasing this product.

- Read these instructions carefully for optimum performance and safety before use.
- Keep this manual for future reference.

Safety Precautions

Read and follow these safety precautions.



WARNING

May cause serious injury or death.

Never do the following about the power plug and cord

(To prevent fire or electric shock)

- Do not plug in or unplug the power cord with wet hands.
- Do not hold or pull on the cord when removing the plug from the socket.
- Do not use a power cord or plug that is damaged. If the power cord is damaged, it must be replaced by the manufacturer, its service agent or similarly qualified persons in order to avoid a hazard.

Observe the following about the power plug and cord

(To prevent fire or electric shock)

- Use a socket that satisfies the rating requirement solely for this appliance. Do not use a plug adaptor or extension cord.
- Always fully insert the power plug into the socket.
- Wipe the power plug periodically with a dry cloth. (Accumulated dust collects moisture, which may cause insulation failure, resulting in fire.)
- Unplug the power cord before cleaning.

Never disassemble, repair or modify the appliance yourself.

- In case of malfunction or failure, immediately stop use, unplug the power cord, and ask your nearest service centre for repair.

Do not allow children to use on their own.

- This appliance is not intended for use by persons (including children) with reduced physical, sensory or mental capabilities, or lack of experience and knowledge, unless they have been given supervision or instruction concerning use of the appliance by a person responsible for their safety.
- Children should be supervised to ensure that they do not play with the appliance.

Keep away from fire.

Do not put flammable materials or clothes with such things attached in the tub. Keep them away from the appliance.

(To prevent explosion or fire)

- For example: Kerosene, gasoline, benzine/thinner, alcohol, etc.

Do not touch the tub until it completely stops.

(To prevent injury)

- If the tub does not stop within 15 seconds when the lid is opened during spin process, switch off the appliance immediately and call a service person.

Provide a ground.

(To prevent electric shock by short circuit)

- Ask a service person to do the grounding work.
- In case of a 2-pin power cord, establish a ground.

Keep magnets and magnetized objects away from the operation panel.

The tub may rotate even when the lid is open, resulting in injury.

Part Names



CAUTION

May cause injury or property damage.

Do not wash, rinse, or spin waterproof sheets or clothes.

(To prevent injury, damage to the main unit, walls, floor or laundry, or water leakage if the appliance falls over or oscillates extremely while spinning)

- Raincoats, wet suits, etc.

Observe the following

- New hose-sets supplied with the appliance are to be used and old hose-sets should not be reused.
- Be careful not to get your fingers caught when opening and closing the lid.
- Do not insert your hands or feet under the main unit. (To prevent injury by rotating parts.)
- Do not climb or put heavy objects on the appliance. (To prevent deformation and breakage resulting in injury)
- If the lid is broken, immediately stop using the appliance. (To prevent deformation and breakage resulting in injury)
- Do not connect to the hot water supply.
- Do not directly pour hot water of 50 °C or higher into the tub.
- Do not add extra water directly into the tub.
- Do not obstruct the openings of the bottom face with carpet, etc.

Turn off the water faucet after operation.

(To prevent water leakage)

This appliance is only suitable for textiles labelled washing machine washable.

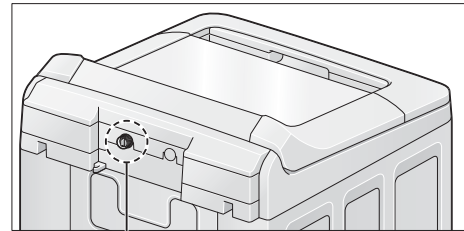
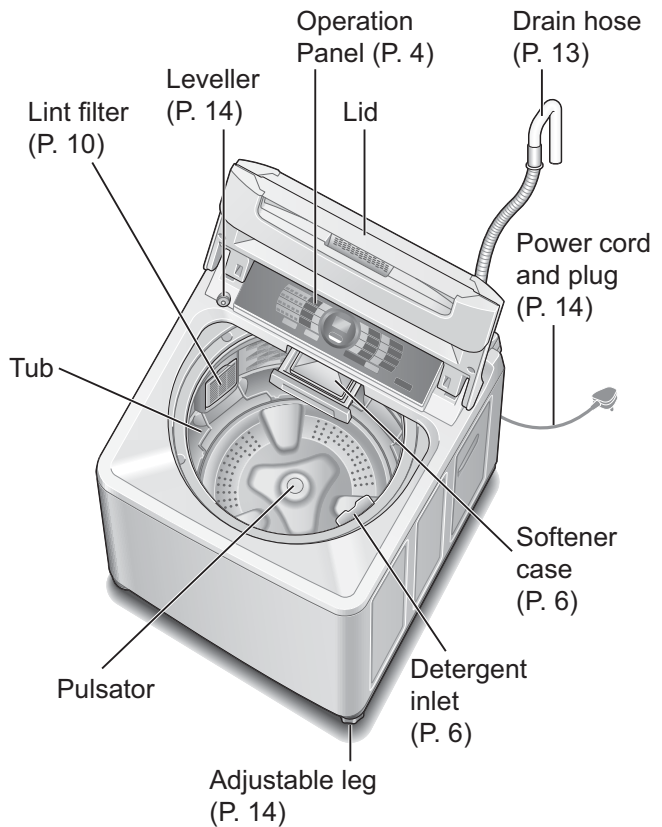

Water supply valve (P. 14)

Accessories

- Water supply hose (1)
- Water tap adaptor (1)
- Bottom cover (1)
- Screw (1)

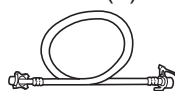

- Length: 1.0 m

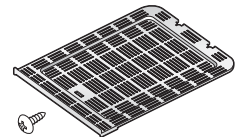
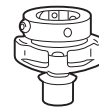

- Drain hose (1)
- Hose band (1)

- Hose holder (1)
- Screw (1)

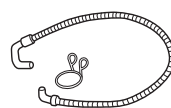

- Washing board (1)

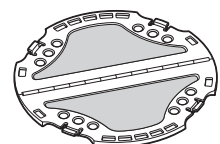

Operation Panel

Change water level

During the wash process, press “Water Level” to change the water level.

- Some water levels cannot be selected depending on the program.
- When the remaining time is displayed, press “Water Level” to check the water level.

Water level/remaining time



After starting operation, indicates the water level according to the amount of laundry.



After approx. 5 seconds, indicates the approximate remaining time (min).

Water level/water amounts

Level	High 10-8	Mid 7-5	Low 4-2	Extra Low 1
Detergent *				
Water amount (L)	96 88 81	74 66 59	52 46 38	33

* : 1 scoop of detergent

- Each water level, except “Extra Low”, has three water amount options that can be switched while the level is lit by pressing “Water Level”.

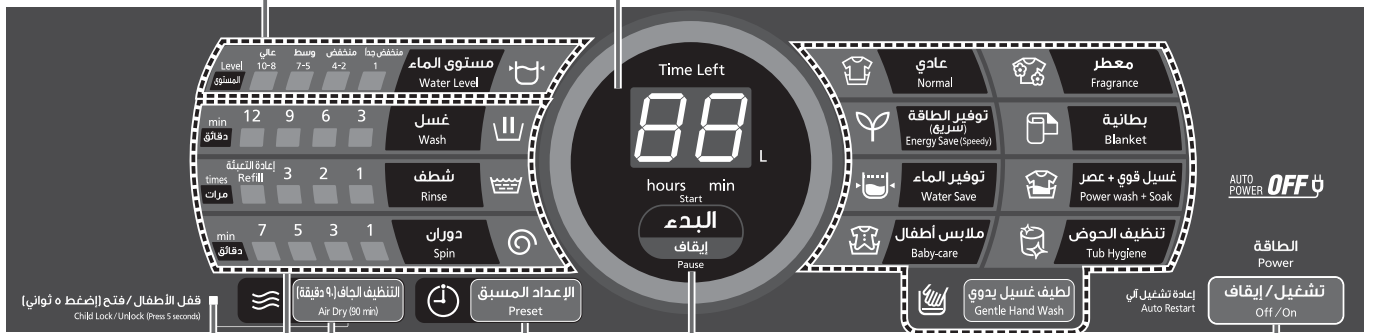

Child Lock lamp (P. 10)

Air Dry (P. 9)

Start/Pause

Program selection (P. 5)

Power Off/On

Change process settings

Change the combination of wash, rinse and spin processes, and the time length or number of times for individual processes. (P. 9)



Lighted

Flashing (in progress)

- After starting operation, you can change settings only during wash process by pressing “Start/Pause”.

Preset

Set the time to finish washing (in hours). (⌚ lights.)





e.g.) 8 hours later

- Setting range: 2 - 24 hours later, in one-hour increments. (3 - 24 hours later for the Power wash + Soak program)
- Not available for the following programs: Gentle Hand Wash, Fragrance, Blanket, Tub Hygiene, Air Dry

NOTE

- In case of a power failure during operation, operation will resume from the point where it was stopped when the power is recovered (Auto Restart).
- The power turns off automatically if you do not press “Start/Pause” within 10 minutes after power-on.

Variety of Programs

Purpose		Program	Maximum capacity
Everyday clothes 	Daily washing	Normal (P. 7)	15.0 kg
Saving energy and time * Reduces the power consumption of Normal program by 5 %.	Speedy washing for light soil	Energy Save (Speedy) (P. 7)	15.0 kg
Saving water * To rinse thoroughly, use the Normal or Baby-care program.		Water Save (P. 7)	15.0 kg
Clothes for babies & people with sensitive skin	Rinsing thoroughly	Baby-care (P. 7)	15.0 kg
Using extra softener	Stronger scent	Fragrance (P. 7)	15.0 kg
Blankets 		Blanket (P. 8)	4.2 kg
Heavily soiled clothes	Presoaking then washing with powerful swirling water	Power wash + Soak (P. 7)	15.0 kg
Delicates 	Washing delicates gently	Gentle Hand Wash (P. 8)	2.5 kg
Tub cleaning	Preventing black mould and smell	Air Dry (P. 9) Tub Hygiene (P. 11)	—
	If black mould or smell is present	Tub Hygiene (P. 11)	—
Drying synthetic fibre clothes		Air Dry (P. 9)	3.0 kg

Operation Panel

Variety of Programs

NOTE

- Normal program and Water Save program are recommended for a normally soiled load at the rated capacity of this washing machine.

Laundry preparation and check

For clothes losing colour easily
Wash separately.



Pre-laundry check

To prevent damage to clothes, malfunction and drainage failure

- Remove coins, pins, paper clips, nails, etc.
- Fasten buttons and close zippers.
- Do not wash items (such as paper diapers) other than laundry.
- Reverse clothes with surface likely to flake off.
- Use a brush to remove pet and human hair, sand, etc.
- Tie strings, etc.

For delicate underwear only

Use laundry nets.

- Underwire brassieres
- Lacy clothes, lingerie and stockings

When using a net

- Do not overpack.
- Put the zipper's slider into the cover. (To prevent damage to clothes and the main unit)
- Do not use the Air Dry program. (To prevent uneven drying and wrinkles)

Detergent

Put in detergent, bleach and softener according to the water level displayed.

- Follow the instructions on each package.

■ Softener case
Softener

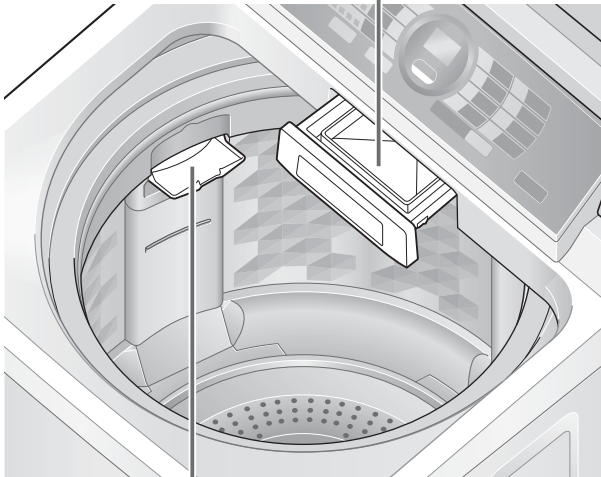

■ Detergent inlet
Detergent/Bleach

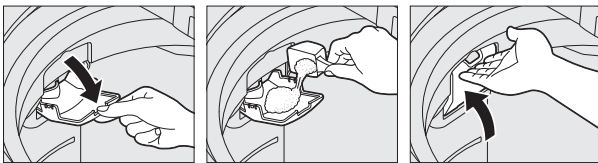

- Turn the tub by hand if it is difficult to put in the detergent inlet. (P. 10)
- Attach the detergent inlet cover if it comes off.

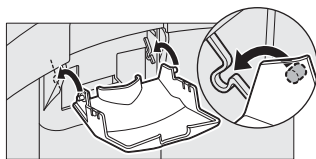

Putting in detergent

Do not put detergent directly into the tub.
Detergent may remain undissolved.

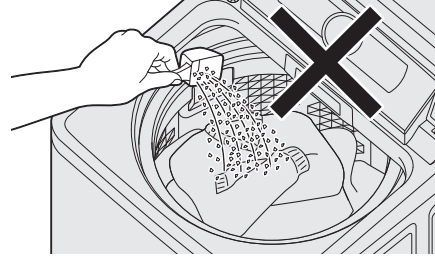

- The level of foaming depends on condition such as load size, degree of soiling, detergent type, and water hardness.

Putting in bleach

- Do not use chlorine bleach for coloured clothes to prevent loss of colour.
- After using chlorine bleach, wash the tub with the Tub Hygiene program without bleach. (P. 11)
- Do not use bleach for the Gentle Hand Wash program.

Putting in softener

- Softener is automatically released during the final rinse process.
- To add softener during operation, press "Pause" first.
- Up to about 160 ml can be added. To add more softener, use the Fragrance program.
- When using concentrated softener, dilute it with water before putting it in.

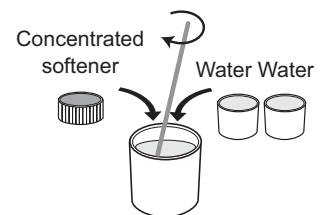

NOTE

- Softener cannot be used with the Water Save program.
- Do not use separated or solidified softener.

Washing

Preparation:

- Check if the washing machine is properly installed. (P. 12)
- Turn on the water faucet.

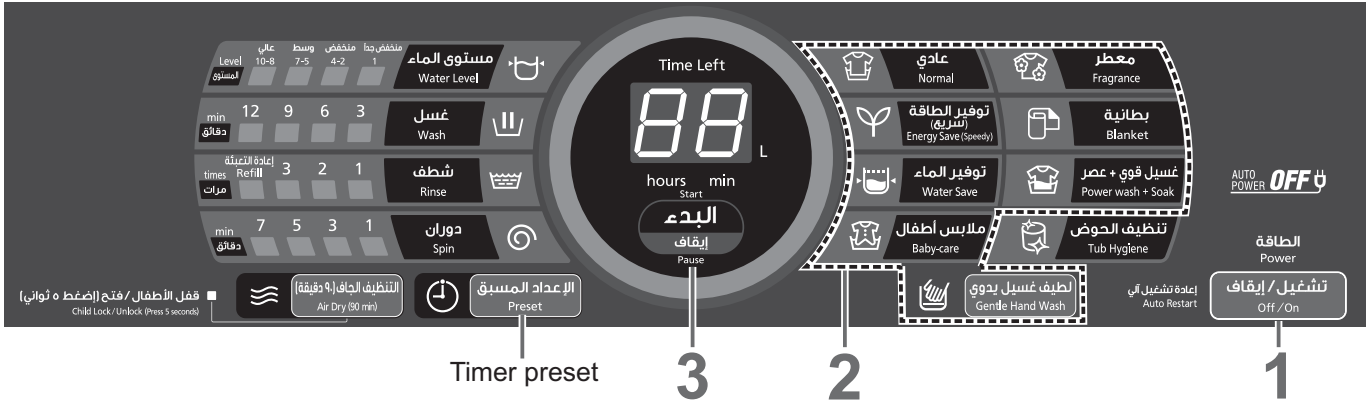

1 After loading laundry
تشغيل / إيقاف Turn the power on.
 Off / On

- The Normal program is selected when the power is turned on.

2 Select a program. (P. 5)
 ■ Timer preset

3 **Start.**
 The pulsator moves without water and measures the amount of laundry (approx. 5 seconds).

Water level indication
 (approx. 5 seconds)

Remaining time indication

- To check the water level → Press "Water Level".

4 According to the water level indication
Put in detergent.

- Approx. 20 seconds after the water level is displayed, water supply begins.

5 Close the lid.

Operation ends with beeps.

Set how many hours later to finish operation. (P. 4)



- 2 minutes after start-up, all indications except turn off.
- To confirm after the timer has been set, press
- To cancel or change, press
- The hours that can be set differ depending on the program.

When the Fragrance program is selected

The buzzer sounds before the final rinse and operation is paused. Put the desired amount of softener which has been diluted with water directly into the tub.



- The Fragrance program cannot be selected when Child Lock (P. 10) is set.
- Operation will resume if the lid is left closed for more than 1 hour.

■ After pressing "Start"

- You can change the water level until the end of the wash process.
- You can change each of the "Wash", "Rinse" and "Spin" operation contents until the end of the wash process. Press "Pause" beforehand.
- You cannot change the program.

Washing Options

Blanket

■ Washable blankets

- Material: 100 % synthetic fibre or 100 % cotton
- Weight: 4.2 kg or less
- Blankets with a machine-washable tag attached

- Put a blanket in the net and load it in the tub.

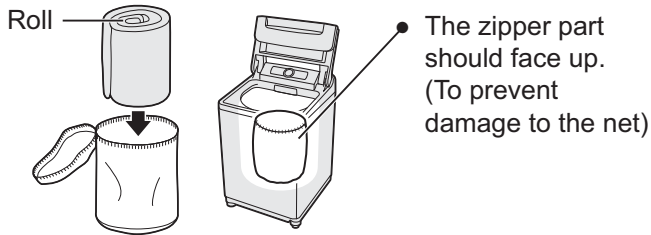

NOTE

- Use liquid detergent.
- The water level indication shows the maximum and cannot be changed.

Gentle Hand Wash

Use this program to gently wash delicate clothes and stylish garments.

Attach the washing board.

- 1) Double up the board and put it in the base.

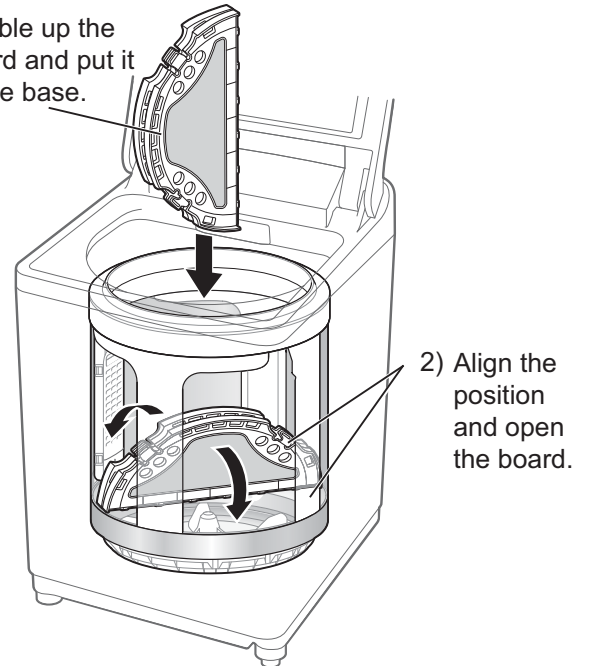

- 3) Press the board circumference and fix it.

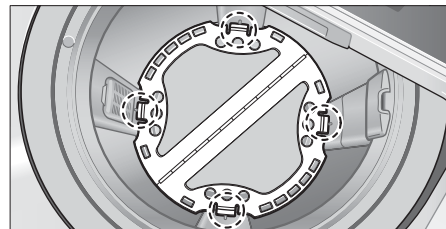

- Set the claws (4 places) securely.

Load the laundry.



Load laundry evenly.

- Load lighter items first and press them from above.
- Use laundry nets for delicate underwear only.
- Amount that can be washed at one time:

Water Level	Capacity
46 L	2.5 kg
38 L	1.2 kg

NOTE

- Do not use bleach.
- Use liquid delicate detergent.
- After operation ends, take out clothes immediately. (To prevent wrinkles and colour staining)

Air Dry



Water is removed from clothes by the air blown from the tub rotation.

■ Clothes that can be dried

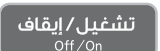
- Material: Synthetic fibre
- Weight: 3 kg or less

1 After loading clothes and closing the lid
 **Turn the power on.**

2  **Press.**

3  **Start.**

After 90 minutes, drying ends with beeps.



NOTE



- Clothes may not be sufficiently dried depending on the amount and type of clothes, the temperature, and the installation condition of the washing machine.
- Since no heater is used for this function, you may feel that clothes are cold and half dry.

Wash / Rinse / Spin

Preparation: Turn on the water faucet.

1 After loading laundry
 **Turn the power on.**

2 

 According to your purpose
Change process settings.
 • Change the water level as necessary.

3 After closing the lid
 **Start.**

Operation ends with beeps.

Contents of Programs

Program	Total time (approx.)	Wash	Rinse ¹⁾	Spin
Normal	60 min	12 min	Refill 2 times	5 min
Energy Save (Speedy)	55 min	9 min	Refill 2 times	5 min
Water Save	80 min	12 min	3 times	5 min
Baby-care	75 min	12 min	Refill 2 times	7 min
Fragrance	85 min	12 min	2 times	5 min
Blanket	75 min	12 min	Refill 2 times	3 min
Power wash + Soak	120 min ²⁾	(Soak 60 min) + 12 min ³⁾	Refill 2 times	5 min
Gentle Hand Wash	45 min	12 min	Refill 2 times	1 min
Tub Hygiene	150 min ²⁾	(Soak 60 min) + 12 min ³⁾	Refill 2 times	7 min

NOTE

- **Total time is an estimation.**
(When the standard water supply rate is 15 L / min)
- Total time may increase depending on low water pressure, bad draining conditions, and the amount and type of clothes.

- 1) Refill:
It fills the tub with water, and rinses laundry while supplying water.
- 2) Remaining time of 90 minutes or less will be displayed.



- 3) Although the time indication is "12 min", soaking is done before that.

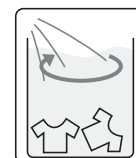

Convenient Functions

Cancelling end buzzer

1  **Pressing down,**
 **press.**

Then hold on for 3 seconds.

2 short beeps

4 short beeps

- To reset, do the same procedure.

Setting Child Lock

To prevent children from falling into the tub and drowning, if the lid is opened while the washing machine is operating, this function sounds a buzzer until it is closed. Not closing it within 10 seconds flushes the water out.

- This function does not lock the lid and button operations.
- When water is drained forcibly, "U 99" is displayed. (P. 16)

1 After closing the lid  **Turn the power on.**

2  **Press and hold for 5 seconds.**

2 short beeps



- To cancel, do the same procedure.

4 short beeps

Turning the tub by hand

If it is difficult to reach the detergent inlet.

1  **Turn the power on.**

2 When a clicking sound is heard **Turn the tub.**
(Clockwise only)

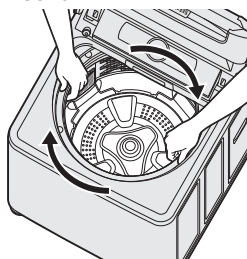

NOTE

- If there is water in the tub or "Start" is pressed, the tub cannot be turned.

Maintenance

Lint filter

After each operation

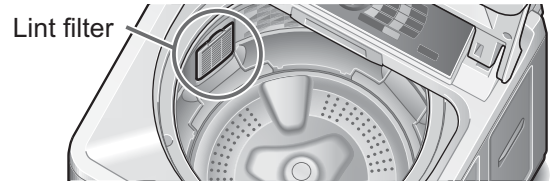

1 **Remove the filter.**

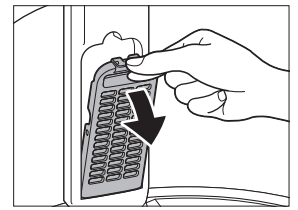

2 **Open the filter and remove lint.**

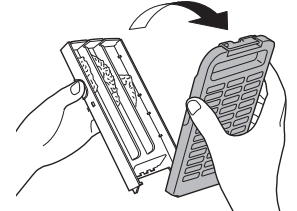

- If lint is difficult to remove, soak and wash the filter in water.

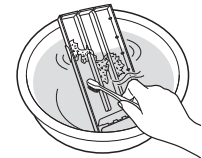

3 **Attach the filter in its original position.**

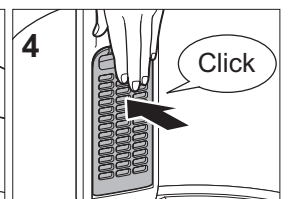
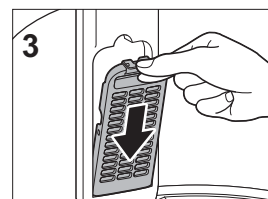
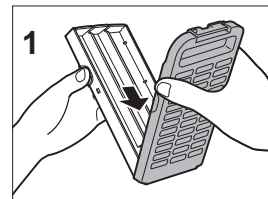

NOTE

- Do not wash laundry without the filter. (To prevent damage to clothes)
- Turn the tub by hand if it is difficult to remove the filter.
- If the filter is broken, purchase a new one at your local dealer.

Water supply filter

If water does not flow smoothly

- Follow the procedure below to prevent splashing of water.

1 After turning off the water faucet

تشغيل / إيقاف
Off / On

Turn the power on.

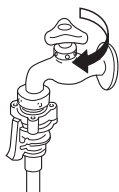

2 Start.

Start
البدء
إيقاف
Pause

3 After approx. 40 seconds

تشغيل / إيقاف
Off / On

Turn the power off.

4 Loosen the nut and remove the hose.

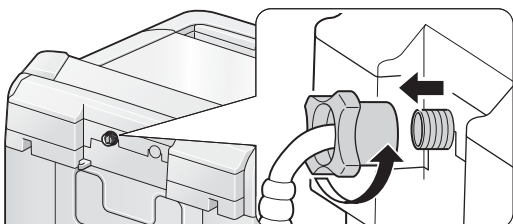

5 Remove the filter and remove dirt on the filter.

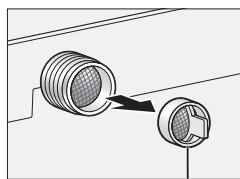

Water supply filter

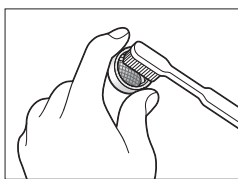

Main unit, lid

If stained with detergent or softener

Wipe with a soft cloth.

(To prevent damage to resin parts or metal corrosion)

- For heavy soil, wipe with a neutral kitchen detergent.
- Do not splash water.

Tub

Once a week <Air Dry>

1 After operation ends
Run the Air Dry program without loading laundry. (P. 9)

Once a month <Tub Hygiene>

Preparation: Turn on the water faucet.

1 Without loading laundry

تشغيل / إيقاف
Off / On

Turn the power on.

2 Press.

تنظيف الحوض
Tub Hygiene

3 Start.

Start
البدء
إيقاف
Pause

Start.



3 When the tub is filled with water

Start
البدء
إيقاف
Pause

Pause.

4 Put bleach in the tub.

- Use chlorine bleach for clothes.



Approx. 200 ml

5 After closing the lid

Start
البدء
إيقاف
Pause

Start.



After approx. 2 hours and a half, tub cleaning ends.

Softener case

Wash with water.

- How to remove
After pulling the case all the way out, pull it obliquely upward to remove it.

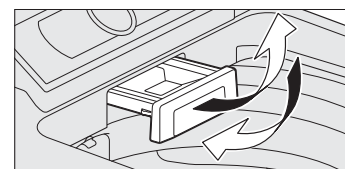

Installation

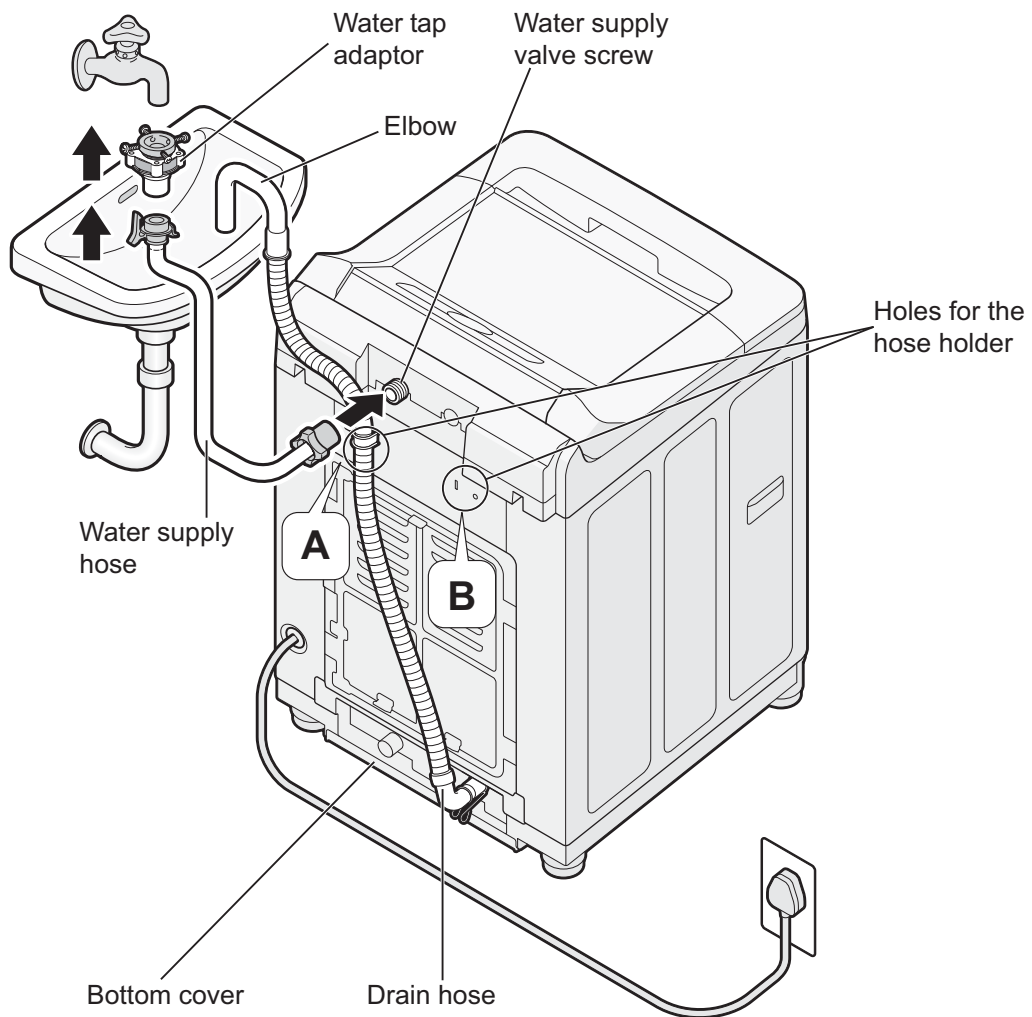

1. Check the location.

■ Avoid the following locations for installation.

- Locations with a possibility of freezing
- Damp locations or locations where it may be exposed to rain, etc. (To prevent electric shock or fire)
- Locations exposed to direct sunlight (To prevent malfunction or deformation)
- Uneven or unstable locations (on blocks, timbers, a table with wheels, etc.)

2. Attach the bottom cover.

1 Insert the bottom cover along the guides.

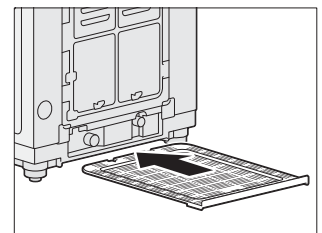

2 Fix with a screw.

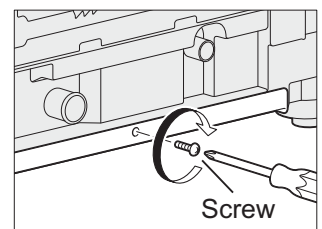

- Make sure to ask a service person for installation. Do not install by yourself.
- If the installation, test run and inspection of the washing machine are not carried out following this installation method, Panasonic will not be liable for any accident or damage caused.

3. Attach the drain hose.

1 Connect.

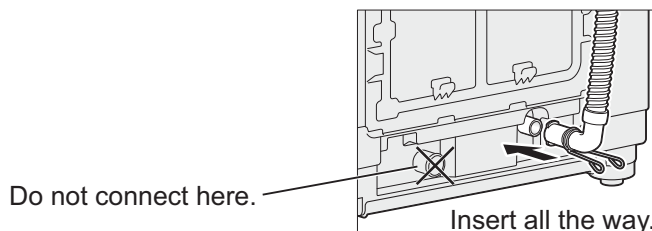

2 Slide the hose band in the arrow direction.

- Slide all the way until it stops.

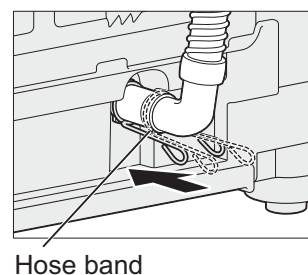

3 Attach the hose to position A or B with the hose holder and the screw.

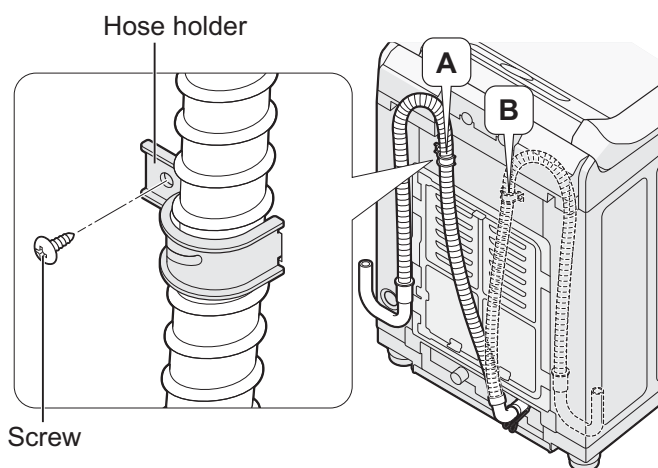

4 Hook the elbow of the drain hose to the basin.

⚠ CAUTION

Make sure the drain hose is securely hooked so that it does not come off by water pressure during drainage.

NOTE

- Do not twist, pull out or bend the drain hose.
- Do not put the hose tip under water.
- Do not direct the drain hose downwards.

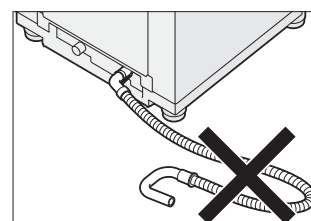
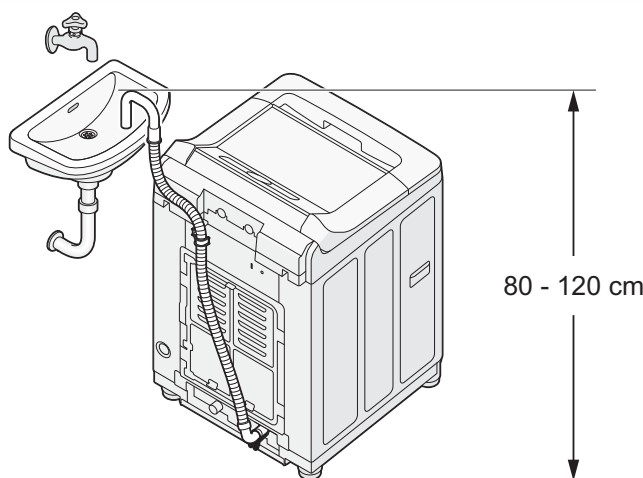

4. Connect the water tap adaptor and water supply hose.

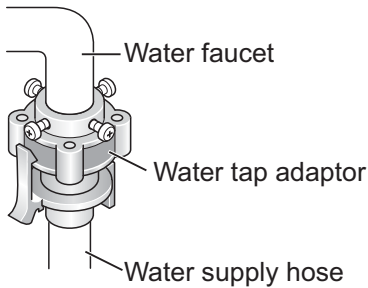

CAUTION

- Tighten the nut firmly.
- Do not twist, squash, modify or cut the hose.

1 Connect the water tap adaptor to the water faucet.

- 1 Turn part A to the left until approx. 4 mm of the thread becomes visible.
- 2 Loosen the 4 screws.
- 3 Connect to the faucet and tighten the screws.
- 4 Turn part A to the right and tighten securely. (To prevent water leakage)

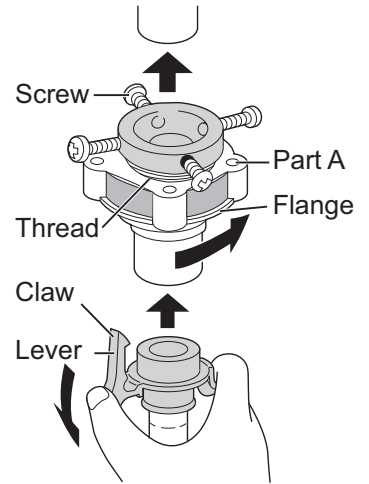

2 Connect the water supply hose to the water tap adaptor.

Insert the hose into the adaptor while pushing down the lever, and hook the claw of the lever on the flange of the adaptor.

3 Connect the water supply hose to the water supply valve screw.

- 1 Hold the elbow and tighten the nut.
- 2 Check that the elbow is not loose.

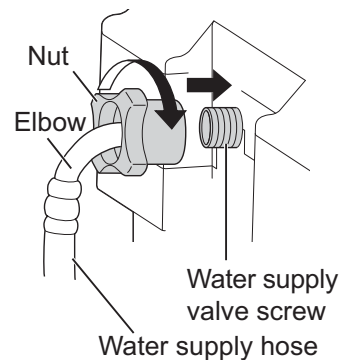

5. Connect the power plug and grounding wire.

- Ask a service person to do the grounding work.
- In case of a 2-pin power cord, establish a ground.

6. Check that the washing machine is level.

The bubble should be at the centre of the mark.

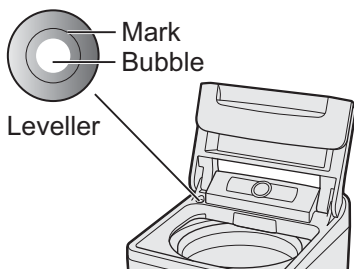

■ If the bubble is out of the mark



- 1 Turn the adjustable leg knob to the left to loosen.
 - 2 Turn the adjustable leg to eliminate wobble.
 - 3 Turn to the right to tighten.
- Labels: To raise, To lower

7. Perform a trial operation.







- Check that there is no water leakage, abnormal sounds or error display.

Troubleshooting

	Symptoms	Points to be checked
Time	Time indication increases or does not decrease	<ul style="list-style-type: none"> Time indication is approximate. Remaining time is corrected during operation and displayed.
	Operation time is longer than the time indication. Operation does not stop even after the preset time.	<ul style="list-style-type: none"> The operation time may be longer if laundry is concentrated on one side or the water supply or drainage is not good. (P. 16 "U 11" "U 14")
Main unit	No operation	<ul style="list-style-type: none"> Power failure? Is the lid closed completely? Has the power fuse blown or the breaker tripped? Is the power plug inserted completely? Is the water faucet turned on? Did you press "Start"? Is the timer preset?
	Cannot change process settings (after start-up).	<ul style="list-style-type: none"> Process settings can be changed during wash process by pressing "Pause". To change the program or settings after the end of wash process, turn the power off and on again.
Wash	No water supply	<ul style="list-style-type: none"> Is the water faucet turned on? Water outage? Is the water supply filter clogged with dirt? (P. 11)
	Water is supplied in the middle of wash process.	<ul style="list-style-type: none"> If the water level drops, water is added automatically. With a large amount of laundry, water is added several times automatically.
	The water level is too high for the amount of laundry.	<ul style="list-style-type: none"> If laundry is wet or there is water in the tub before operation, the water level may be higher.
	The water level is too low for the amount of laundry.	<ul style="list-style-type: none"> With light clothes (of synthetic fibre, etc.), the water level may be lower.
Rinse/Spin	Operation started with rinse, but water is not supplied.	<ul style="list-style-type: none"> If there is no water in the tub, water is supplied after spin. If there is water in the tub, water is supplied after water discharge.
	Operation suddenly changes to rinse process in the middle of spin. Only spin is desired, but operation starts with rinse.	<ul style="list-style-type: none"> If clothes are concentrated on one side of the tub, the washing machine automatically corrects unevenness by starting rinse process. (Place clothes as evenly as possible.)
	Irregular rotation during spin	<ul style="list-style-type: none"> The tub rotation speed is adjusted to reduce foaming during spin.
Others	Power failure/ The breaker has tripped.	<ul style="list-style-type: none"> Operation will resume from the point where it was stopped when the power is recovered (Auto Restart).
	Water outage	<ul style="list-style-type: none"> When water supply is recovered, remove the water supply hose, release turbid water from the faucet, and then start the washing machine.
	Cannot select the Fragrance program.	<ul style="list-style-type: none"> If Child Lock (P. 10) is set, the Fragrance program cannot be selected.
	There is noise when water drains out	<ul style="list-style-type: none"> This is normal. It is the noise of the drain pump working.

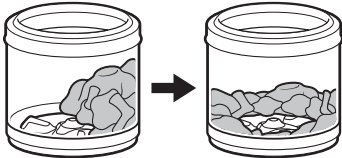
Error Display

- The buzzer sounds and “U”/“H” and a number are alternately displayed.
- Cancel Child Lock (P. 10) if it is set.

Error display	Points to be checked
	<p>Water cannot drain. Check the drain hose for the following abnormalities:</p> <ul style="list-style-type: none"> • Is it crushed? • Is it clogged with lint? • Is the hose tip under water? <p>When the above problems are solved, you can resume operation by opening and closing the lid.</p>
	<p>The lid is open.</p> <ul style="list-style-type: none"> • Did you try to run the washing machine with the lid open? →Close the lid.
	<p>Spin or Air Dry is not possible.</p> <ul style="list-style-type: none"> • Are clothes concentrated on one side of the tub? →Distribute the clothes evenly and close the lid. • Is the washing machine installed on an unstable or inclined surface? →You can resume operation by opening and closing the lid. 
	<p>Water cannot be supplied.</p> <ul style="list-style-type: none"> • Is the water faucet turned on? • Water outage? • Is the water supply filter clogged with dirt? (P. 11) →You can resume operation by opening and closing the lid.
	<p>Water has been forcibly drained.</p> <ul style="list-style-type: none"> • Water has been forcibly drained because the lid was open for 10 seconds or more with Child Lock (P. 10) set. →Unplug the power cord and plug it in again after 5 seconds.
	<p>Inspection is required.</p> <ul style="list-style-type: none"> • Unplug the power cord. Then, report the error displayed (2-digit number after “H”) to a service person.

Specifications

	NA-F150A3
Rated voltage	220-240 V
Rated frequency	50 Hz
Rated power consumption	540 W
Standard water amount	96 L
Maximum capacity	15 kg
Product dimensions	643 mm (W) x 709 mm (D) x 1074 mm (H)
Product weight	48 kg
Pressure of tap water	0.01 - 1 MPa

Panasonic Corporation

<http://www.panasonic.com>

© Panasonic Appliances (Thailand) Co., Ltd. 2015