

# Panasonic®

Operating Instructions  
(Household use) Rechargeable Shaver  
Model No. ES-L550U

## Contents

---

|                                    |           |   |           |
|------------------------------------|-----------|---|-----------|
| <b>Safety precautions.....</b>     | <b>2</b>  | <b>Replacing the system<br/>outer foil .....</b>            | <b>14</b> |
| <b>Important information .....</b> | <b>6</b>  | <b>FAQ .....</b>  | <b>15</b> |
| <b>Parts identification .....</b>  | <b>7</b>  | <b>Troubleshooting .....</b>                                | <b>15</b> |
| <b>Preparation.....</b>            | <b>8</b>  | <b>Battery life .....</b>                                   | <b>18</b> |
| <b>How to use .....</b>            | <b>10</b> | <b>Removing the built-in<br/>rechargeable battery .....</b> | <b>18</b> |
| <b>Cleaning the shaver .....</b>   | <b>13</b> | <b>Specifications .....</b>                                 | <b>19</b> |

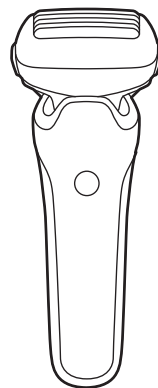

Thank you for purchasing this Panasonic product.

**Before operating this unit, please read these instructions completely and save them for future use.**

The USB power adaptor is sold separately.

## Safety precautions

Make sure to follow these instructions.

To prevent accidents, injuries or damage to property, please follow the instructions below.

- **The following chart indicates the degree of damage caused by improper operation.**

 **DANGER** Indicates a potential hazard that will result in serious injury or death.

 **WARNING** Indicates a potential hazard that could result in serious injury or death.

 **CAUTION** Indicates a potential hazard that could result in minor injury or property damage.

- **The symbols are classified and explained as follows.**

 This symbol indicates prohibition.

 This symbol indicates requirement that must be followed.

## WARNING

### ► This product

**This product has a built-in rechargeable battery. Do not throw into fire, apply heat, or charge, use, leave, or store in a high temperature environment.**



- Doing so may cause overheating, ignition, or explosion.

**Do not modify or repair.**



- Doing so may cause fire, electric shock, or injury.

Contact an authorized service centre for repair (replacement of battery etc).



**Never disassemble except when disposing of the product.**

- Doing so may cause fire, electric shock, or injury.

### ► Power supply

**Do not use in a way that would exceed the rating of the household outlet or the wiring.**



- Exceeding the rating by connecting too many plugs to one household outlet may cause fire due to overheating.

**Disconnect the USB plug when cleaning the main body with water.**



- Failure to do so may cause electric shock or injury.

**Fully insert the power plug of the USB power adaptor securely.**



- Failure to do so may cause fire or electric shock.

## **WARNING**

### ► **USB power adaptor and USB cable:**

**Do not immerse them in water or wash with water.**

**Do not place them over or near water filled sink or bathtub.**

**Never use the appliance if they are damaged or if the power plug fits loosely in a household outlet.**



**Do not damage them.**

• **Do not deface, modify, forcefully bend or pull them. Also, do not place anything heavy on, twist or pinch them.**

- Doing so may cause electric shock or fire due to a short circuit.

**Do not use them to charge other devices.**

**[Note that USB power adaptor (ES-RU1-02) can be used with compatible Panasonic products.]**



- Doing so may cause burns or fire due to a short circuit.

**Do not connect or disconnect them with a wet hand.**



- Doing so may cause electric shock or injury.

**Always plug the USB cable to a power supply with a rated voltage of 5.0 V and a rated output current of 1.0 A which meets requirements of the Safety Extra Low Voltage (SELV) system.**



- Failure to do so may cause burns or fire due to a short circuit.

**Use the specified USB power adaptor and USB cable.**



- Failure to do so may cause burns, electric shock or fire due to a short circuit.

**Regularly clean them to prevent dust from accumulating.**



- Failure to do so may cause fire due to insulation failure caused by humidity.

Remove the USB power adaptor and wipe it with a dry cloth.

## WARNING

### ► In case of an abnormality or malfunction

**Immediately stop using the device and disconnect the USB power adaptor.**

- Failure to do so may cause fire, electric shock, or injury.

**<Abnormality or malfunction cases>**



• The main unit, USB power adaptor or USB cable is deformed or abnormally hot.

• The main unit, USB power adaptor or USB cable smells of burning.

• There is an abnormal sound during use or charging of the main unit.

- Immediately request inspection or repair at an authorized service centre.

### ► Preventing accidents

**Do not place within reach of children or infants. Do not let them use it.**



- Putting parts or accessories in the mouth may cause an accident or injury.

**If oil is consumed accidentally, do not induce vomiting, drink a large amount of water and contact a physician.**



**If oil comes into contact with eyes, wash immediately and thoroughly with running water and contact a physician.**

- Failure to follow these instructions may result in physical problems.

### ► Take care of the following precautions as well

**This appliance is not intended for use by persons (including children) with reduced physical, sensory or mental capabilities, or lack of experience and knowledge, unless they have been given supervision or instruction concerning use of the appliance by a person responsible for their safety.**



**Children should be supervised to ensure that they do not play with the appliance.**

- Failure to do so may cause an accident or injury.

## CAUTION

### ► Protecting the skin

**Do not use excessive pressure to apply the system outer foil to your lip or other part of your face.**



**Do not apply the system outer foil directly to blemishes or injured skin.**

- Doing so may cause injury to skin.

**Do not forcefully press the system outer foil. Also, do not touch the system outer foil with fingers or nails when in use.**



**Do not use this product for hair on head or any other part of the body.**

- Doing so may cause injury to skin or reduce the life of the system outer foil.

## CAUTION

-  **Check the system outer foil for cracks or deformations before use.**  
- Failure to do so may cause injury to the skin.

### ► Note the following precautions

-  **Do not allow metal objects or trash to adhere to the power plug of USB power adaptor or USB plug.**  
- Doing so may cause electric shock or fire due to a short circuit.

-  **Do not charge when the appliance socket is wet.**  
- Doing so may cause burns or fire.

-  **Do not share your shaver with your family or other people.**  
- Doing so may result in infection or inflammation.

-  **Disconnect the USB power adaptor from the household outlet when not charging.**  
- Failure to do so may cause electric shock or fire due to electrical leakage resulting from insulation deterioration.

## Handling of the removed battery when disposing

### DANGER

-  **The rechargeable battery is exclusively for use with this appliance. Do not use the battery with other products.**
- Do not charge the battery after it has been removed from the product.**
- Do not throw into fire or apply heat.**
- Do not hit, disassemble, modify, or puncture with a nail.**
- Do not let the positive and negative terminals of the battery get in contact with each other through metallic objects.**
- Do not carry or store the battery together with metallic jewellery such as necklaces and hairpins.**
- Do not use or leave the battery where it will be exposed to high temperatures, such as under direct sunlight or near other sources of heat.**
- Never peel off the tube.**  
- Doing so may cause overheating, ignition, or explosion.

## **⚠️ WARNING**

- After removing the rechargeable battery, do not keep it within reach of children and infants.**
- The battery will harm the body if accidentally swallowed.  
If this happens, consult a physician immediately.

- If the battery fluid leaks out and comes in contact with the eyes, do not rub the eyes, and thoroughly rinse with clean water, such as tap water.**
- Failure to do so may cause eye injury.  
Consult a physician immediately.

## **⚠️ CAUTION**

- If the battery fluid leaks out and comes in contact with the skin or clothes, rinse off with clean water, such as tap water.**
- Failure to do so may cause inflammation.

## **Important information**

- This WET/DRY shaver can be used for wet shaving using shaving lather or for dry shaving. You can use this watertight shaver in the shower and clean with water. The following symbol means suitable for use in a bath or shower.



- Treat yourself to wet lather shaves for at least three weeks and notice the difference. Your Panasonic WET/DRY shaver requires a little time to get used to because your skin and beard need about a month to adjust to any new shaving method.
- If you clean the shaver with water, do not use salt water or hot water. Do not soak the shaver in water for a long period of time.
- Charge the appliance correctly according to these Operating Instructions. (See page 8 "Charging the shaver".)
- This appliance contains battery that is only replaceable by skilled persons. Please contact an authorized service centre for the details of repair.
- Do not recharge non-rechargeable batteries.

### **Note the following precautions in order to prevent malfunction, deformation and deterioration**

- Do not drop or hit against other objects.
- Do not bring the system outer foil into contact with hard objects.

- Do not leave the shaver exposed to direct sunlight with the foil frame detached.
- Do not dry the main unit with a dryer.
- Be sure to place the protective cap on the shaver when carrying around or storing.
- Store the shaver in a place with low humidity after use.



This symbol on the product means that not generated higher voltage than the safety extra low voltage (SELV). In which protection against electric shock relies on power supply.

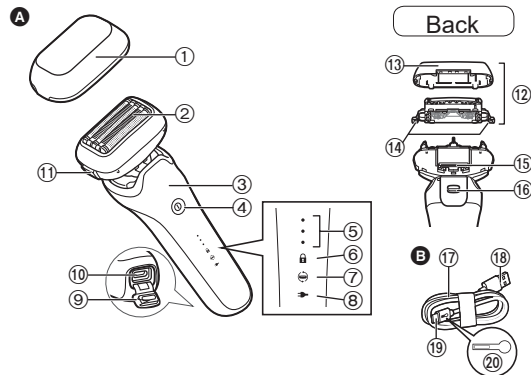

## Parts identification



### A Main body

- ① Protective cap
- ② System outer foil
- ③ Finger rest
- ④ Power switch
- ⑤ Battery capacity lamp
- ⑥ Switch lock lamp (  )
- ⑦ Foil/blade check lamp (  )
- ⑧ Charge status lamp (  )
- ⑨ Socket cover
- ⑩ Appliance socket (Type-C)
- ⑪ Foil frame release buttons

### ⑫ Outer foil section

- ⑬ Foil frame
- ⑭ System outer foil release buttons
- ⑮ Trimmer
- ⑯ Trimmer handle

### B USB cable

- ⑰ Cord
- ⑱ USB plug (Type-A)
- ⑲ USB plug (Type-C)
  - With overheat protection function
- ⑳ Overheat protection function mark

## Accessories

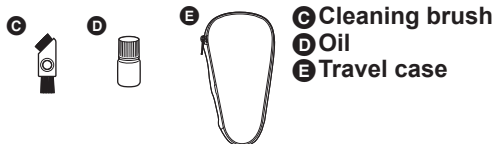

## Optional parts



## Preparation

### Charging the shaver

- Turn the shaver off.
- Wipe and dry any water droplets or facial cleanser on the appliance socket.
- Use the specified USB power adaptor and USB cable.
- The USB power adaptor is sold separately.



**1** Open the socket cover and insert the USB plug firmly into the main body and USB power adaptor.

**2** Insert the USB power adaptor firmly into a household outlet.

- Check that the charge status lamp (→) is glowing.
- Charging is completed after approx. 2 hours.

**3** Remove the USB power adaptor from the household outlet, and remove the USB plug from the main body after the charge status lamp (→) turns off.

- Close the socket cover.

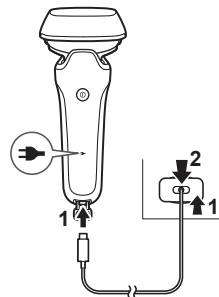

### Note

You cannot operate the shaver while charging.



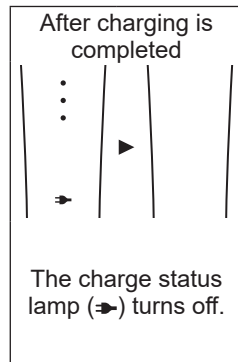
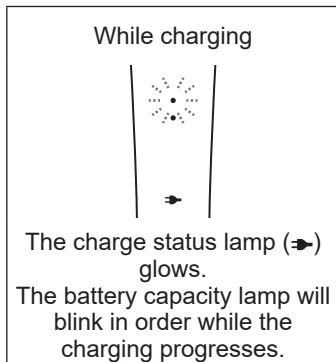

- The shaver can be used for approximately 2 weeks with a full charge.  
(Based on one 3-minute dry-shave usage per day in an ambient temperature range of 20 °C – 30 °C.)  
The number of usable days varies depending on the following conditions.
  - Beard thickness
  - Pressure applied to the skin
  - Usage frequency of the shaving foam mode or wet shaving.
- If there is noise from the radio or other sources while using or charging the appliance, move to a different location to use the appliance.

### Notes

- The shaver may be charged with adaptors and cables other than the specified ones, but Panasonic's specified adaptor with splash-resistant design and a USB cable with an overheating protection function should be used to ensure safety.  
The adaptor is not completely waterproof, so prevent it from getting wet.
- When charging the shaver for the first time or when it has not been in use for more than 6 months, the charging time may change or the charge status lamp (➔) may not glow for a few minutes. It will eventually glow if kept connected.
- Recommended ambient temperature for charging is 10 °C – 35 °C. Charging may take longer, or the charge status lamp (➔) will blink quickly, indicating that the battery is not charging properly in extremely high or low temperatures.

## How to use

### Making foam in shaving foam mode

It is easier to make foam this way than by hand.

#### ► Usable facial cleansers, etc.

|                 |   | Shaving | Shaving foam mode |
|-----------------|---|---------|-------------------|
| Shaving agent   | Shaving foam  | ✓       | —                 |
|                 | Shaving gel   | ✓       | ✗                 |
|                 | Shaving cream                                       | ✗       | ✗                 |
| Facial cleanser | Facial cleansing foam (without scrubbing compounds) | ✓       | ✓                 |
|                 | Facial cleansing foam (with scrubbing compounds)    | ✗       | ✗                 |
|                 | Facial soap   | ✓       | ✗                 |
| Body soap etc.  | Liquid  | ✓       | ✓                 |
|                 | Foam  | ✓       | —                 |

- Do not use anything other than above listed shaving agent/facial cleanser/body soap etc. as these may cause the blades to clog, or be unable to make foam.
- Check that the socket cover is closed.

### 1 Preparing foam

Scoop a suitable amount of facial cleanser or similar in your hand, and add a suitable amount of cold or warm water.

### 2 Hold ① for 2 seconds or more to switch to shaving foam mode.

- The battery capacity lamps blink in order.

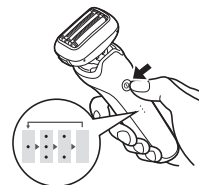

- The shaving foam mode ends after 15 seconds. The shaver can then be used to shave.
- To stop using the shaving foam mode and start shaving, press the power switch once.

### 3 Press the blades gently in the palm of your hand, mix the facial cleanser etc. around and move the blades up and down to make foam.

- If there is insufficient foam, add slightly more water, hot water or facial cleanser etc. to make it easier to create foam.

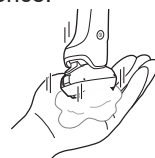

#### ► Notes

- Do not use shaving agent (excluding foam), facial cleansing foam (with scrubbing compounds) or soap as these may cause the blades to clog, or be unable to make foam.

## Shaving beard

- Check the system outer foil for cracks or deformations before use.

### 1 Press ① and shave.

- The “shaving sensor”, which automatically adjusts the power depending on the beard thickness, will operate.

The shaver adjusts its power, delivering high performance on areas with dense beard growth and reducing power on areas with lighter growth, minimizing strain on the skin.

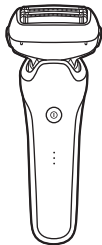

### Tips for better shaving

Apply the whole system outer foil perpendicularly against the skin and shave by slowly gliding the shaver over the face against the grain of the beard.

- The beard under the chin and around the throat can be shaved better by stretching the skin so the beard will stand.
- To prevent damaging the system outer foil, do not shave with only a part of the system outer foil.



### 2 Press ① when finished.

When the battery capacity is low

The appliance beeps after switched off.

- You can shave 2 to 3 times after the charge status lamp (→) blinks. (This will differ depending on usage.)

### Notes

- The appliance may not operate in an ambient temperature lower than approximately 5 °C.
- The shaving sensor may not respond depending on the type and quantity of the shaving gel. This is not abnormal.
- To prevent erroneous operation, place your fingers on the finger rest while using the shaver.

### ► Using the trimmer

1. Slide the trimmer handle up to the “mm” position so that the trimmer stands upright.
2. Press ① and use.

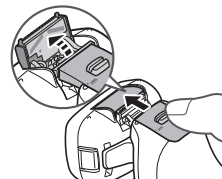

Press and hold the top knob (a) and slide the trimmer handle down to lower the trimmer.

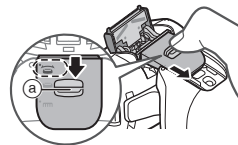

## Tips for better usage

Apply the trimmer edge perpendicular to skin gently and move downward slowly.

Trimming sideburns

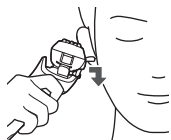

Pre-shave of long beards



## ► Switching the shaver head

You can change the pivot action.

“☺”

The shaver head is moved to prevent missed spots.



“☹”

You can lock the shaver head.

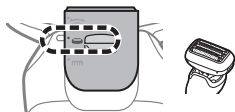

## Operation and display of the switch lock

### ► Locking the power switch

1. Press ① once and then release.

- The shaver starts operating.

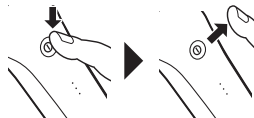

2. Hold ① for more than 2 seconds until the switch lock lamp (🔒) turns on.

- The shaver will stop operating.

3. Release ①.

- The switch lock lamp (🔒) will turn off after 5 seconds.

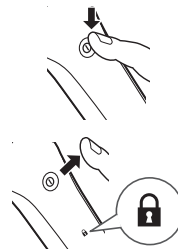

### ► Unlocking the power switch

1. Hold ① for more than 2 seconds.

- The shaver starts operating.

2. Release ①.

- The power switch is locked when the switch lock lamp (🔒) blinks for 5 seconds and the shaver does not operate even though the power switch is pressed.

## Cleaning the shaver

We recommend cleaning the shaver after each use.

### Cleaning with water

- Turn the shaver off and disconnect the USB plug.
- Check that the socket cover is closed.

**1 Apply some hand soap and some water to the system outer foil.**



**2 Press  and make foam for several seconds, then press  to stop making foam.**

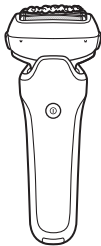

**3 Remove the outer foil section and clean with running water.**

- See page 14 for removing the outer foil section.
- After rinsing with water, shake the shaver up and down for a few times to remove excess moisture and then wipe off any drops of water with a dry cloth.



**4 Dry the outer foil section, the shaver, and the trimmer completely.**

- Allow the shaver to dry in the shade, avoid direct sunlight.



**5 Lubricate the shaver.**

It will keep the movement of the blades smooth and maintain a comfort shave.

1. Apply one drop of oil to each of the system outer foils.
2. Raise the trimmer and apply a drop of oil.
3. Switch the shaver on, and run it for approximately five seconds.
4. Switch off the shaver, and wipe off any excess oil from the system outer foil with a soft cloth.



### Notes

- Do not use any kitchen or bathroom detergents other than hand soap. Doing so may cause malfunction.
- Be careful not to hit the main body on the sink or any other object while draining the water. Failure to do so may cause malfunction.
- Do not wipe with thinners, benzine, alcohol etc. Doing so may cause malfunction, cracking or discoloration of the parts. Wipe with diluted soapy water.

## Cleaning with the brush

Remove the outer foil section.  
(See this page.)

Clean the system outer foil in the areas indicated by the circles every time you use the shaver. Otherwise, abnormal sound may be generated.

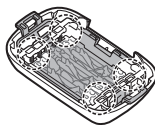

## ► Cleaning with the long brush

Clean the foil frame, system outer foil, the main body and the trimmer using the long brush.



## Replacing the system outer foil

☹️ glows once every 18 months. (Based on one 3-minute shave use per day)

We recommend checking the system outer foil when it appears.

- Press the power switch for more than 30 seconds to reset the cumulative usage duration and make ☹️ blink.

|                   |                                     |
|-------------------|-------------------------------------|
| system outer foil | Approximately once every 18 months* |
|-------------------|-------------------------------------|

\* The replacement timing is a recommendation and is subject to individual usage and preference.

## ► Removing the outer foil section

Press the foil frame release buttons and lift the outer foil section upwards.

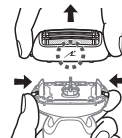

## ► Attaching the outer foil section

After turning the foil frame mark (⚡) to the front, securely attach the outer foil section to the shaver until it clicks.

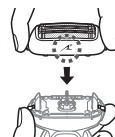

## ► Replacing the system outer foil

1. Press the system outer foil release buttons and pull down the system outer foil.

- Do not press the system outer foil release buttons with excessive force.

Doing so may bend the system outer foil, preventing complete attachment to the foil frame.

2. Align the foil frame mark (⚡) and the system outer foil mark (△) and securely attach together until it clicks.

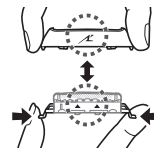

## Note

Do not throw away the foil frame.

## ► Replacement parts and optional parts

Replacement parts and optional parts are available at your dealer or Service Centre.

|                                |                   |           |
|--------------------------------|-------------------|-----------|
| Replacement parts for ES-L550U | System outer foil | WES9510   |
| USB power adaptor              |                   | ES-RU1-02 |

## FAQ

| Question   | Answer  |
|--|---|
| Does this product require inner blades?                                  | ▶ Outer foils and inner blades are integrated into the system outer foil.   |
| Will the battery deteriorate if not used for an extended period of time? | ▶ The battery will deteriorate if not used for over 6 months, so make sure to perform a full charge at least once every 6 months.           |
| Can I charge the shaver after every use?                                 | ▶ The battery used is a lithium-ion, so charging after every use will have no effect on battery life.                                       |
| Why should the adaptor be disconnected after charge?                     | ▶ Charging the battery for more than 2 hours will not affect battery performance, but disconnect the adaptor for safety and to save energy. |
| What is the constituent of the dedicated oil?                            | ▶ Constituent of the oil is liquid paraffin.  |
| Why does the appliance beep twice after switched off?                    | ▶ The sound indicates that the battery capacity is running low. Please charge the appliance.  |

## Question

Can I use the self-cleaning recharger?

## Answer

▶ No, the shaver does not have terminals to connect with the self-cleaning recharger.

## Troubleshooting

Perform the following actions.

If the problems still cannot be solved, contact the store where you purchased the unit or a service centre authorized by Panasonic for repair.

### ▶ Shaver

| Problem                            | Action   |
|------------------------------------|--|
| The power switch does not turn ON. | ▶ Unlock the switch lock. (See page 12.)                         |
| The power will not switch to OFF.  | ▶ Press the power switch twice while using in shaving foam mode. |

| Problem                              | Action   |
|--------------------------------------|--|
| The shaving sensor does not respond. | <ul style="list-style-type: none"> <li>▶ Depending on the beard thickness or the amount of beard trimmings in the shaver head, the shaving sensor may not react and the driving sound may not change. This is not abnormal.</li> </ul> |
|                                      | <ul style="list-style-type: none"> <li>▶ The shaving sensor may not respond depending on the type and quantity of the shaving gel. This is not abnormal.</li> </ul>  |
|                                      | <ul style="list-style-type: none"> <li>▶ The shaving sensor may not respond when the remaining battery capacity is low. If this happens, recharge the shaver.</li> </ul>   |
|                                      | <ul style="list-style-type: none"> <li>▶ Apply oil. (See page 13.) The shaving sensor may not respond when there is not enough oil on the system outer foil.</li> </ul>  |

| Problem   | Action  |
|---|---|
| The shaving sensor responds even though the shaver is not in contact with the skin. | <ul style="list-style-type: none"> <li>▶ Clean the beard trimmings from the shaver. Clean the system outer foil with the brush. (See page 14.) Wash the system outer foil with water. (See page 13.)</li> <li>▶ Replace the system outer foil.</li> </ul> |
| Foam cannot be made in shaving foam mode.   | <ul style="list-style-type: none"> <li>▶ Making foam may be difficult depending on the type of facial cleansers etc., so adjust the amount of water or facial cleanser.</li> </ul>  |
| Foam made in shaving foam mode contains shavings.                                   | <ul style="list-style-type: none"> <li>▶ Before making foam, cleanly rinse off any shavings. (See page 13.)</li> </ul>  |



| Problem                                      | Action  |
|--|---|
| Shaver does not operate even after charging. | <ul style="list-style-type: none"> <li>▶ Use the appliance in an ambient temperature approximately 5 °C or higher.</li> <li>▶ The battery has reached the end of its life.</li> </ul> <p>The shaver will not operate with the USB power adaptor connected. Please use the shaver after it has been sufficiently charged and the USB power adaptor disconnected.</p> |
| Shaver does not charge.                      | <p>Check the appliance socket for moisture from water or facial cleanser.</p> <p>The overheat protection function may be actuated to stop charging.</p> <ul style="list-style-type: none"> <li>▶ Dry the appliance socket thoroughly before attempting to charge the shaver again.</li> </ul>   |

| Problem   | Action   |
|---|--|
| Operating time is short even after a full charge. | <ul style="list-style-type: none"> <li>▶ When the number of operations per charge starts to decrease, the battery is nearing the end of its life.</li> <li>▶ Apply oil.</li> <li>▶ Clean the shaver.</li> </ul> <p>The operating time may decrease depending on how you use the foam making mode or wet shaving.</p> |
| The driving sound changes while shaving.          | <ul style="list-style-type: none"> <li>▶ The shaving sensor is operating. The sound changes depending on the beard thickness.</li> </ul>   |

| Problem                                    | Action   |
|--|--|
| Makes a loud sound.                        | Apply oil.<br>The blades will not move smoothly when there is no oil on the system outer foil, requiring more power.     |
|  | The shaver makes a high-pitched sound due to the linear motor drive. This does not indicate a problem.                   |
|  | Confirm that the system outer foil is properly attached.   |
|  | Clean the system outer foil with the brush.<br>▶ (See page 14.)<br>Wash the system outer foil with water. (See page 13.) |
| The odor is getting stronger.              | ▶ Clean the shaver.  |
| System outer foil gets hot.                | ▶ Apply oil.   |
|  | ▶ Replace the system outer foil if it is damaged or deformed. (See page 14.)   |
| You do not get as close a shave as before. | ▶ Clean the shaver.  |
|  | ▶ Apply oil.   |
|  | ▶ This can be improved by replacing the system outer foil.   |

## Battery life

The life of the battery is 3 years. The battery in this shaver is not intended to be replaced by consumers. Have the battery replaced by an authorized service centre.

## Removing the built-in rechargeable battery

**Remove the built-in rechargeable battery before disposing of the shaver.**

The battery is to be disposed of safely.

Please make sure that the battery is disposed of at an officially designated location if there is one.

This figure must only be used when disposing of the shaver, and must not be used to repair it. If you dismantle the shaver yourself, it will no longer be waterproof, which may cause it to malfunction.

- Remove the shaver from the USB power adaptor.
- Press the power switch to turn on the power and then keep the power on until the battery is completely discharged.

- Perform steps ① to ⑤ and lift the battery, and then remove it.
- Take care not to short circuit the positive and negative terminals of the removed battery, and insulate the terminals by applying tape to them.

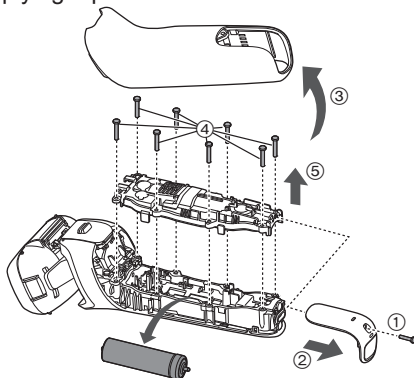

#### For environmental protection and recycling of materials

This shaver contains a Lithium-ion battery. Please make sure that the battery is disposed of at an officially assigned location, if there is one in your country.

## Specifications

|   |   |
|---|---|
| Output rating of applicable adaptor (sold separately) | 5.0 V $\overline{=}$ 1.0 A<br>In compliance with the Safety Extra Low Voltage (SELV) system |
| Motor voltage   | 3.6 V $\overline{=}$  |
| Charging time   | Approx. 2 hours   |

This product is intended for household use only.

Panasonic Corporation  
<https://www.panasonic.com>  
© Panasonic Corporation 2025