



Panasonic®

Operating Instructions Refrigerator

For Household Use



Model No.: **NR-XY680L**

Contents

• Safety Precautions.....	2	• Filter Change	30
• Usage Precautions.....	6	• Wireless LAN	30
• Installation.....	8	• Fridge compartment.....	32
• Parts Identification	19	• Prime Fresh case.....	34
• Operation Panel.....	21	• Freezer compartment.....	35
• Temperature Control	22	• Water Filter Cartridge	
• ECONAVI Operation	24	Installation and Replacement	38
• nanoe™ X.....	24	• How to clean the Refrigerator	40
• Quick Freezing.....	25	• Panasonic SmartApp+	47
• Prime Fresh+	25	• Troubleshooting	51
• Prime Freeze	26	• Specifications.....	58
• Quick Ice Making	28	• Disposal	58
• Auto Ice Off and Auto Ice Clean.....	29	• Copyright.....	59
• Child Lock	29		

■ NON-CFC

NON-CFC MATERIALS have been used for the refrigerant (R600a) and for the insulation (Cyclo-Pentane), making this product better for the Earth's Ozone Layer.

Thank you for purchasing the Panasonic product.

- Please read these instructions carefully and follow safety precautions on page 2-7 before using this product.
- Please make sure the date and name of store of purchase are stamped in warranty card and keep it with this operating instructions.

AU/NZ

ARAH1E203472
P0623-2073
Printed in Vietnam

Safety Precautions

Please be sure to follow these instructions.



WARNING

This sign means: It may lead to a serious injury or death.



These signs mean prohibited action.



This sign means required action.



This sign means the appliance must be earthed to prevent electric shock.



CAUTION

This sign means: It may result in injury or property damage.



iso-butane

Risk of fire / flammable materials.

Otherwise, it may cause a fire, injury, electrical shock.



WARNING

In case of emergency:



- Maintenance work should only be carried out by a qualified technician.



- **Do not** store explosive substances, such as aerosol cans with a flammable propellant, etc. in the refrigerator.
- **Do not** use electrical appliances such as a deodorizer in the refrigerator. Leaked refrigerant may catch fire from a spark of the electrical contacts and may cause an explosion.
- **Do not** use electrical appliances inside the food storage compartments of the appliance, unless they are of the type recommended by the manufacturer.



- **Do not** disassemble, repair or modify the refrigerator by yourself. If you want to repair the refrigerator, please consult your dealer or authorized service center.
- **Do not** use mechanical device or other means to accelerate the defrosting process, other than those recommended by the manufacturer.

When recycling the product:



- Before taking the refrigerator to be recycled, please remove all the door opening seal to prevent locking a child in it.
- The warning labels mentioned above should be kept throughout the life of the refrigerator.
- The operating instructions should be handed over to any person who would use or handle the refrigerator whenever the refrigerator would be transferred to another location and delivered to a recycling plant.
- In regards to local laws, Cyclo-Pentane is used for insulation of this refrigerator. When you throw away this unit, please discard it by proper method and do not dispose it by burning.

Otherwise, it may cause a fire, injury, electrical shock.



WARNING

For power plug and cord:



- **Do not** plug or unplug with wet hands.
- **Do not** let the cord or plug be damaged.



- Disconnect power plug when cleaning.
- Only plug into a wall outlet of the correct rated voltage and current, and fully insert the plug on its own.
- Reserve one socket for the refrigerator only. Avoid connecting many appliances to the same socket and unroll the full length of the cord.
- Remove dust periodically from the power plug.
- If the power cord is damaged, it must be replaced by the manufacturer, its service agent or similarly qualified persons in order to avoid a hazard.
- If you detect burning smell, disconnect the power plug and ventilate the kitchen.
- **Stop** using the refrigerator and unplug the unit immediately if there is an abnormality or failure. Abnormality and failure examples:
 - Power cord or plug is abnormally hot.
 - Power cord is deeply cut or deformed.
 - There is burning smell.
 - You can feel tingling electricity.

When using:



- **Do not** damage the cooling circuit (piping on the back).
- **Do not** touch the compressor and pipes, because of high temperature, that there is a risk of burn injury.
- **Do not** let any children hang onto the refrigerator's door, it may fall and injure the child.
- **Do not** place or store open containers of water on top of the refrigerator. Spilled water can cause electrical shocks or combustion.
- **Do not** place multiple socket-outlets or portable power supplies at the rear of the appliance.
- Keep ventilation openings, in the appliance enclosure or in the built-in structure, clear of obstruction.



- This appliance is not intended for use by persons (including children) with reduced physical, sensory or mental capabilities, or lack of experience and knowledge of using the appliance, unless they have been given supervision or instruction concerning use of the appliance by a person responsible for their safety.
- Children should be supervised to ensure that they do not play with the refrigerator.

When installing:



- Danger can occur when the appliances is unbalanced, make sure the feet are secure and appliance is level.
- When positioning the appliance, ensure the power cord is not trapped or damaged.



- Ensure that the refrigerator is plugged into an earthed mains socket.

Otherwise, it may
cause a fire, injury,
electrical shock.



WARNING

R600a refrigerant warning:

This appliance contains flammable R600a refrigerant. Avoid safety hazards by carefully installing, handling, servicing and disposing of this appliance.

- Keep ventilation openings, in the appliance enclosure or in the built-in structure, clear of obstruction.
- Ensure that the tubing of the refrigerant circuit is not damaged during transportation and installation.
- Leaking refrigerant may cause eye injuries or ignite.
- The room for installing appliance must be at least 1 cubic metre per 8 gram of refrigerant. The amount of refrigerant in the appliance can be found on the rating plate inside the appliance.
- If you are unsure of the refrigerant, check the rating plate inside the refrigerator compartment.
- It is hazardous for anyone other than an Authorised Service Person to service this appliance. In Queensland Australia the Authorisation Service Person **MUST** hold a Gas Work Authorisation for hydrocarbon refrigerants to carry out servicing or repairs which involves the removal of covers.
- Do not use mechanical devices or other means to accelerate the defrosting process, other than those recommended by the manufacturer.

Water Connection System Warning (For Auto Ice and Water Dispenser models only)

- Before installing the Water Connection System, read the steps for installing (Page 12 - Page 18) and follow the instructions carefully to minimize the risk of water damage.
- Installation and use **MUST** comply with all state and local plumbing codes. Check with your local public works department for plumbing codes. You must follow their guidelines as you install the Water Connection System.
- Only connect your Water Connection System to safe drinking water to avoid illness or poisoning.
- **Do not** reuse any existing water connections. When installing the product, please use new tubing supplied with the refrigerator.
- **Do not** install if water pressure is above 827 kPa (120 psi) or below 172 kPa (25 psi).
- The Water Filter Cartridge should be changed when the Filter Change LED on the Operation Panel is illuminated orange. The replacement of Water Filter Cartridge is recommended every 6 months.
- Installation of the Water Connection system should be carried out by a licensed plumber or the Panasonic Authorised Repairer.

Otherwise, it may
cause a fire, injury,
electrical shock.



WARNING

- Water Filter replacement is the consumer's responsibility and will not be covered by the warranty except in the case of faulty parts or materials with the Water Filter Cartridge.
- Replacement parts can be purchased at all authorized service centers. (This service is available to selected markets only).
- In cases of excessively reduced filter life, we recommend that you consult a local plumber or your water supplier for advice on suitable filtration requirements for the water supplied to your home.
- If Auto Ice maker and Water Dispenser are not used for a long period of time, or the water or ice has an unpleasant taste or odour, please dispose of remaining water and ice and clean the Auto Ice making system. Detail of Auto Ice Clean, please see in Page 29. If the problem persists, please replace the Water Filter Cartridge.
- Avoid contact with the moving parts of the Auto Ice maker mechanism, and do not place your fingers on the Auto Ice maker mechanism while the refrigerator is in operation.
- When using any electrical device (such as a power drill) during installation, be sure the device is insulated or wired in a manner to prevent electric shock.
- **Do not** use on hot water supply. The Water Connection System is designed with maximum inlet temperature by 43°C.
- **Do not** install system in areas where the ambient temperature may go above 43°C or drop below 5°C.
- **Do not** install the Water Filter in a location that is susceptible to freezing temperatures. Freezing the Water Filter may lead to reduced filter performance, causing property damage from water leakage or flooding.
- **Do not** install the filter or any water tubing in direct sunlight as prolonged exposure to light can weaken plastic components.
- **Do not** allow children under 3 years old to have access to small parts during the installation of Water Connection System to prevent the risk of choking.

Otherwise it may cause injury, accidents.



CAUTION

When opening/closing the doors:



- While opening the refrigerator, be careful not to pinch other one's hand holding the door.
- Mind the gap between the doors. They may nip your hand while closing the door.



When storing food:



- **Do not** freeze glass bottles, that there is a risk of injury. (If the liquid in a glass bottle is frozen, then the bottle may break and you may be injured.)
- **Do not** add a high impact on glass trays. (Otherwise those glass trays may break and you may be injured.)

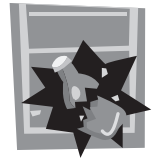

When moving the refrigerator:



- Hold the refrigerator tightly when transporting.
- Apply protective covering, etc. to floors with a fragile surface.

Usage Precautions

When opening/closing the doors:

- **Do not** refrigerate items which are bigger than tray or shelf, as the door will not close completely causing leakage of cool air.
- **Do not** open refrigerator frequently or leave it open for long time in order to prevent water dripping inside and waste energy.
- Frequently check the door opening seal, it must fully seal to the refrigerator's body.

When cleaning:

- **Do not** clean the refrigerator with chemical substances or liquids. It will cause damage and lead to corrosion on the surface.



Usage Precautions

When using:

- When the plug is disconnected, leave it for 7 minutes before plugging again. If not, the compressor may not work.
- Adjust the temperature according to the actual operating condition for energy saving.
- The humidity inside the fresh case may condense so wipe it with a cloth periodically. Clean the fresh case once a month.
- If you will not be at home for several days and there are nothing refrigerated in the refrigerator, the plug should be disconnected for energy saving. When the refrigerator is not used for several days, it is necessary to take out all remaining food inside the refrigerator, clean and open the doors for a few hours to let the moisture inside the refrigerator dry out, avoiding mold and oxidation of components.
- The outside wall of refrigerator cabinet may sometimes get warm, especially just after installation. This is quite normal, and is due to the built-in Mullion Dryer Pipe which prevents sweating and radiates heat.
- When humidity is high, e.g. during rainy-season, condensation may appear on the surface of cabinet, especially around the door seal gasket. Wipe off the condensed water with a clean cloth.
- **Do not** keep the door open any longer than necessary, particularly in hot, humid weather.
- The top of the refrigerator is made of steel in order to prevent fire caused by external influences. **Do not** put things on top of the refrigerator.



When storing food:

- **Do not** overload the refrigerator. Gaps must be provided between foodstuffs to maintain the cooling effect.
- Store fruits and vegetables in vegetable case, where trapped moisture helps preserve food quality for longer time periods.
- Drinking water and beverage bottles should be sealed to prevent odor contamination.
- Food stuff such as vegetables, fruits and fresh food should be wrapped or packed in a box or storage container before freezing.
- Meat and Fish should be put in the Freezer compartment if you want to store them for an extended period.
- Cover juicy food with tight lids, plastic film or foil.



While using the Panasonic SmartApp+™...

Radio waves from the refrigerator's wireless LAN module may cause interference to other devices. Therefore:

- Individuals with pacemakers must keep at least 15 cm away from the refrigerator.
- The refrigerator must be placed away from medical equipments and automated equipment (automatic doors, fire alarms, etc)

Installation

The distance required for installation

- The top of the refrigerator is at least 1 cm from the ceiling.



- The left and right sides of the refrigerator are at least 3 cm from the walls.

- The back of the refrigerator is at least 5 cm from the wall.

Caution

- In case the refrigerator is placed near to walls, it is necessary to ensure that the space between the left or right side of the refrigerator and the wall is at least 35 cm. If this space is less than 35 cm, the doors may not be fully opened and the glass trays, vegetable case, etc. could not be taken out.

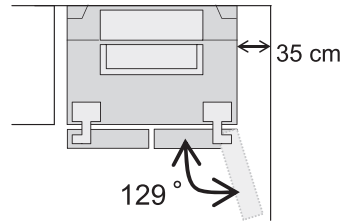

- Do not place any objects on top of the refrigerator. It may become hot due to heat generated by the compressor at the top of the refrigerator. If it is difficult to release heat, the cooling capacity may be lowered.

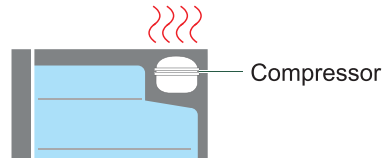

- When using for the first time: clean the inside of the refrigerator.
 - Use a soft damp cloth to clean the refrigerator.
 - Rinse the Water tanks, Water filters and Ice trays.
 - The smell of plastic could be smelt during the first time using the refrigerator. If the smell is a concern, it is recommended to ventilate the room.
- **Do not** place the refrigerator in a humid place as rust may form and may cause electric leakage.
- **Do not** place the refrigerator exposing to direct sunlight as the heat and sunlight will increase the temperature affecting the cooling capacity.
- **Do not** place the refrigerator near heat sources such as cooking stove or oven.
- **Do not** block the openings around the refrigerator.
- The refrigerator must be placed in an area where there is good air circulation.
- If the refrigerator is to be placed on an uneven surface, please adjust the adjuster bolts to ensure that the refrigerator is stable.

LED lamp and grounding

- The refrigerator LED lamp, specifically designed for this refrigerator. Do not replace it by yourself. If the LED lamp needs to be replaced, please contact Panasonic service center.
- If there is no grounding wiring plug in the refrigerator, it should be connected with a grounding connection to prevent electrical hazards from electrical leakage.

Moving or transporting

※ Before moving and transporting

- 1 Remove any food items and dispose of any ice cubes or water that remain in the refrigerator.
- 2 Unplug the refrigerator.
- 3 Adjust the adjuster bolts (left and right) so that they do not touch the floor.
- 4 Place a container underneath the drainage hole, then slowly tilt the refrigerator backward to drain water from the drainage hole. This action requires 4 or more people, of which 2 people lift the front of the refrigerator to prevent the refrigerator from sliding and avoiding the risk of accidents.

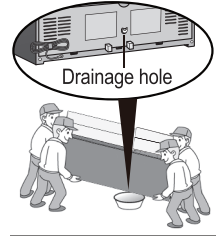

※ How to move and transport

- At least 4 people are required to transport the refrigerator.
- Each person lifts a corner of the refrigerator, 2 people lift the backside of the refrigerator and 2 people lift the bottom of the refrigerator so that their hands are on the hanger positions of the backside and bottom of the refrigerator.
- Do not transport by holding the refrigerator doors.

The backside of refrigerator

The bottom of refrigerator

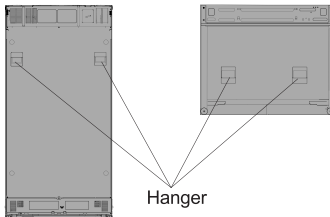

Caution

- It is recommended to use the hangers when moving and transporting.
Do not carry the refrigerator horizontally to avoid the risk of danger due to the heavy weight.
- When transporting, use tape to secure the refrigerator doors and avoid letting the doors open by itself.
- Do not place the refrigerator on its side when transporting, as this may cause damage to the refrigerator.
- After installation, wait at least 4 hours before plugging in the power to ensure that the gas and oil in the compressor are in a stable state.

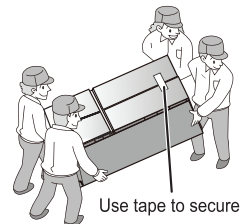

When the left/ right doors are deviated (or the height is not the same)

Turn the adjuster bolt on the lower side, as shown in Image 1, in order to adjust the level. The Fridge/ Freezer doors may tilt within four to five days after installation due to the load of the food or adaptation to the floor surface, turn the corresponding adjuster bolt with the dedicated tool to adjust and level the door again to restore.

If the Fridge doors are still deviated after adjusting the adjuster bolts as above, continue to use Washers A^{*1} as shown in Image 2 to adjust the height of Fridge door.

- 1 Determine the deviation between Fridge doors.
- 2 Select Washer A^{*1} with appropriate thickness (1 mm, 1.5 mm or 2 mm).
- 3 Lift and hold the lower Fridge door.
- 4 Fit a Washer selected in step 2 into the hinge position of the lower Fridge door.
- 5 Check the balance again between the Fridge doors.

In case Freezer doors are deviated, use Washers B^{*2} and apply the same steps as Fridge doors.

^{*1} Washer is used for Fridge doors adjustment.

^{*2} Washer is used for Freezer doors adjustment.

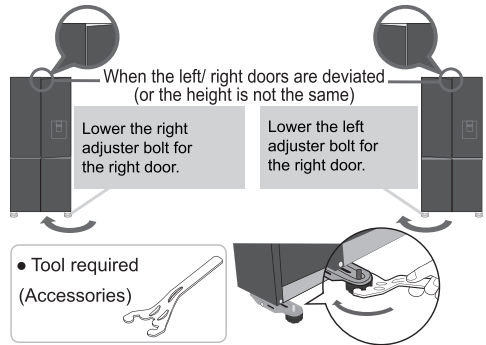

Image 1

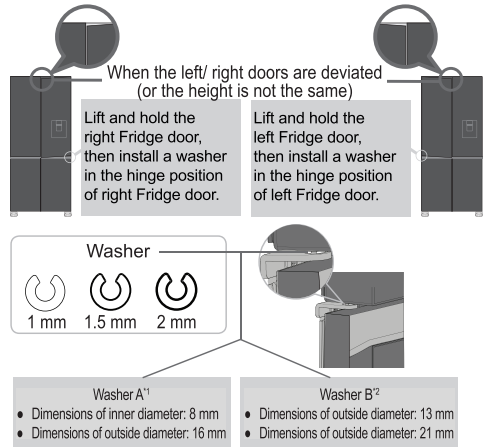

Image 2

Remark

- Use only one Washer for this purpose. Two or more Washers may slip out or make rubbing sound.
- Use the correct Washers for the Fridge/ Freezer doors adjustment.
- Do not lift the door too high. The door can touch and damage the top cover.
- Keep Washers out of reach of children.
- Keep the remaining Washers for future use.

Have any measures been taken against tipping due to earthquakes?

In order to prevent the refrigerator from tipping due to earthquakes, permanently fix it by using belts, etc.

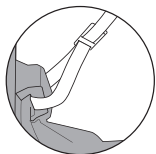

Fix the refrigerator.

Turn the adjuster bolts (right and left) until they reach the floor to stabilize the refrigerator.

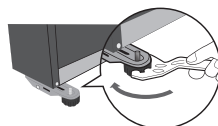

Refrigerator doors should not be opened during the interior cooling process.

The doors should not be opened until the interior has been cooled down sufficiently. (Warm air flowing into the interior will block the cooling function.)

Please wait until the interior has cooled down.

- The refrigerator may take at least 4 hours (or longer especially in summer when the ambient temperature is high) of continuous running to cool down the interior, in the condition of no food items inside and the doors are not opened.
- Depending on ambient temperature and usage condition, it may take 24 hours to cool down the interior and achieve the correct temperatures.



Installation of Water Connection System

※ List of Water Connection System accessories

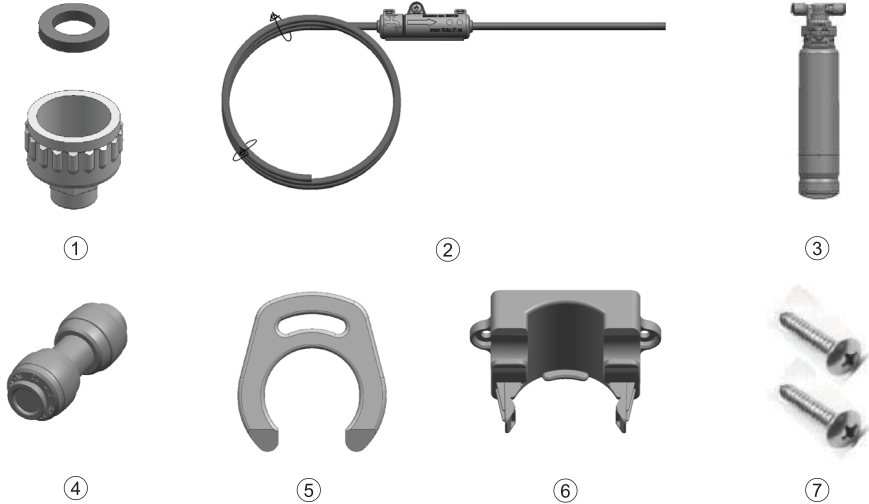

- ① 1 x Joint Water Supply Block (1/2")
- ② 1 x Dual Check Valve Assembly Block
- ③ 1 x Water Filter Cartridge & Filter Head
- ④ 1 x Joint Tube
- ⑤ 4 x Joint Clips (1/4")
- ⑥ 1 x Sub Filter Bracket
- ⑦ 2 x Truss M4x25 (for fixing Sub Filter Bracket)

- Dual Check Valve must be installed to prevent backflow.
- The new tubing supplied with the refrigerator is to be used, old tubing from old water and ice connections should not be used.
- Ensure the Tube Inlet is correctly connected to the Dual Check Valve.
- A licensed plumber installs a new water supply outlet nearer to the appliance should the tubing supplied not be long enough.

It is not recommended that the tubing be extended as this could adversely affect the flow of water to the ice maker or Water Dispenser.

- An isolator ball valve be installed by a licenced plumber for water pressure adjustment and water supply shut off to the refrigerator.
- A noise reduction valve can also be fitted in the water supply line. This will reduce water hammer and its effects from quick action household taps and fast acting valves on appliances.
- Panasonic does not accept responsibility for damage, including water damage caused by faulty installation or plumbing.

Caution

- **Do not** cut any length of tube shorter than 200 mm (7.87”).
- **Do not** fix Water Filter to the refrigerator.
- **Do not** install Water Connection System near electrical wires or water pipes that will be in the path of drilling when selecting the location of the filter system
- **Do not** fix the Water Filter in such a position that it will be struck by other items, such as wastebaskets, etc.
- **Do not** install the Water Filter or any water tubing in high temperature areas eg in a ceiling cavity.
- **Do not** install in a location that is susceptible to freezing temperatures as damage to the housing could occur.
- AVOID contamination of pipes during installation.
- **Do not** use copper tubing. The plastic tubing supplied should always be used.

※ Water Connection System installation instructions

Step 1: Ensure the refrigerator is NOT plugged into a power supply.

Step 2: Locate a cold water supply that is suitable for water connection.

Step 3: Connect 200 mm (7.87”) Tube Filter Inlet (blue tube ¼”) of ② Dual Check Valve Assembly Block with ③ Water Filter Cartridge & Filter Head as instructed in Figure 1.

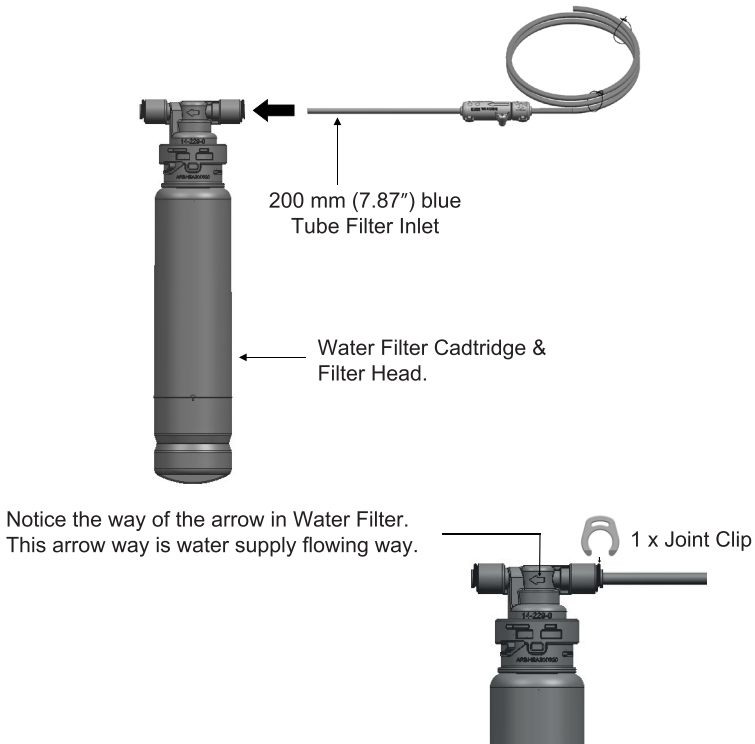

Figure 1: Connect 200 mm (7.87”) Tube Filter Inlet of Dual Check Valve Assembly Block with Water Filter Cartridge & Filter Head

Step 4: Decide the position to fix the Water Filter.

Determine the length of tubing that can be connected from the fixing position of Water Filter to the location of water supply, it's called "Tube A" (Refer to Figure 2).

Cutting tube surface should be flat and perpendicular with the length of tubing to prevent water leaks.

※ **Before cutting**

Water Filter after connected with
200 mm (7.87") Tube and Dual Check Valve.
Fix the position of Water Filter.

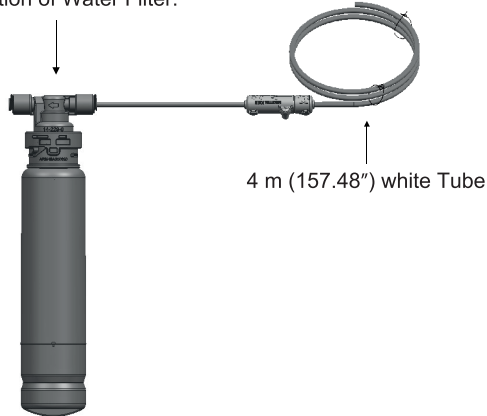

※ **After cutting**

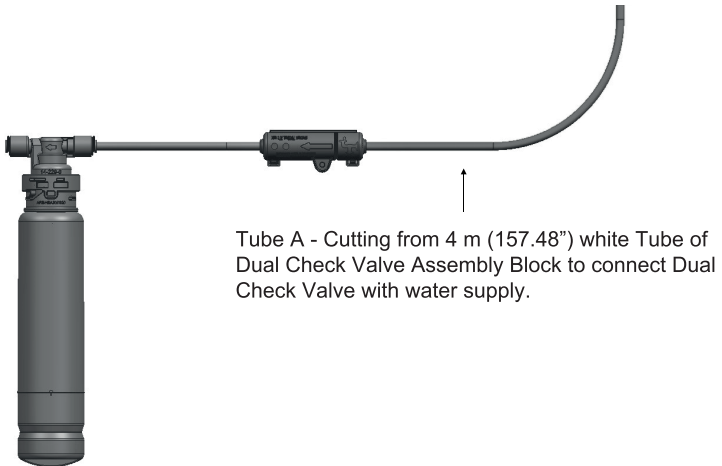
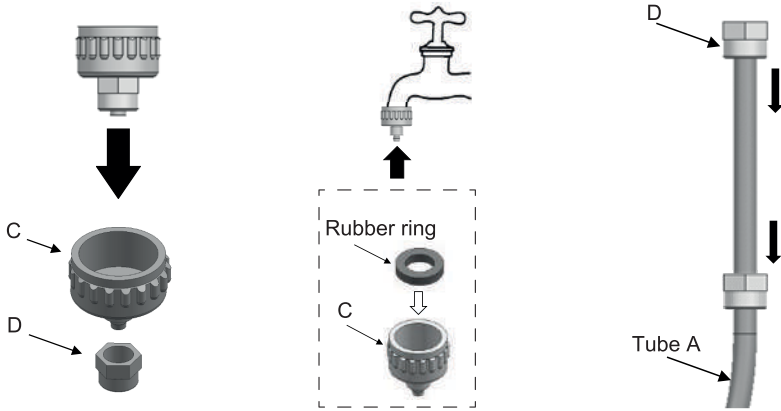

Figure 2: Decide position of Water Filter and cutting "Tube A" to connect Dual Check Valve with water supply.

Step 5: Connect Joint Water Supply to water supply tab as instructed in Figure 3.



Disassemble C & D of Joint Water Supply Block

Connect C with Rubber ring into water supply tab

Insert D into Tube A in Step 4 as shown in above image

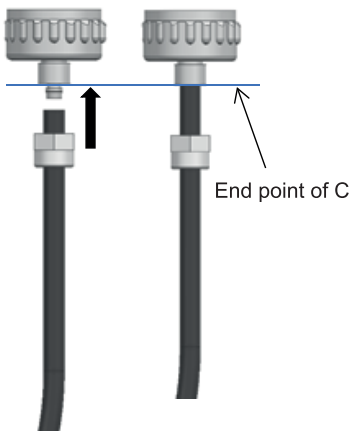

Insert Tube A into C until Tube A reach to end point of C.

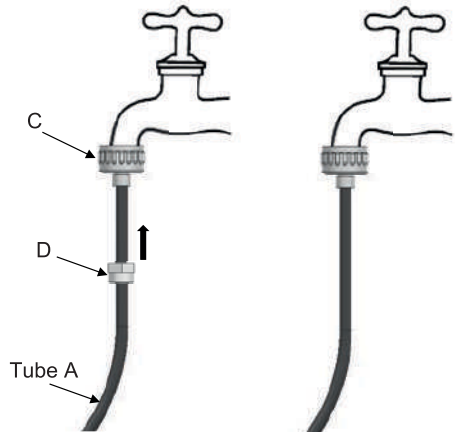

Move up D and screw it to firmly fix Tube A and C.

Figure 3: Connect Joint Water Supply to water supply tab

Step 6: IMPORTANT!

To flush the Water Filter of any trapped air, aim the Water Filter into a bucket, turn water supply tap on and run the water through Water Filter at least 12 liters of water. Once complete, turn water supply tap off. This step is highly recommended to avoid water dripping.

Step 7: Determine the length of tubing that can be connected from the refrigerator to Water Filter, and cut or using the remaining after cutting Tube A of the 4 m (157.48") Tube Valve Inlet (tube 1/4").

It's called "Tube B".

Length of Tube B will be decided according to the location of refrigerator and Water Filter.

Cutting tube surface should be flat and perpendicular with the length of tubing to prevent water leaks.

Step 8: Connect refrigerator and Water Filter by "Tube B" and Joint Tube ④.

Plug the tube into the full depth of the Filter and Joint Tube (15 ~ 18 mm) (0.59 ~ 0.71") to prevent water leaks.

Firmly fix the tube using Joint Clips (1/4").

After Step 8, please check again your tubing layout as Figure 4.

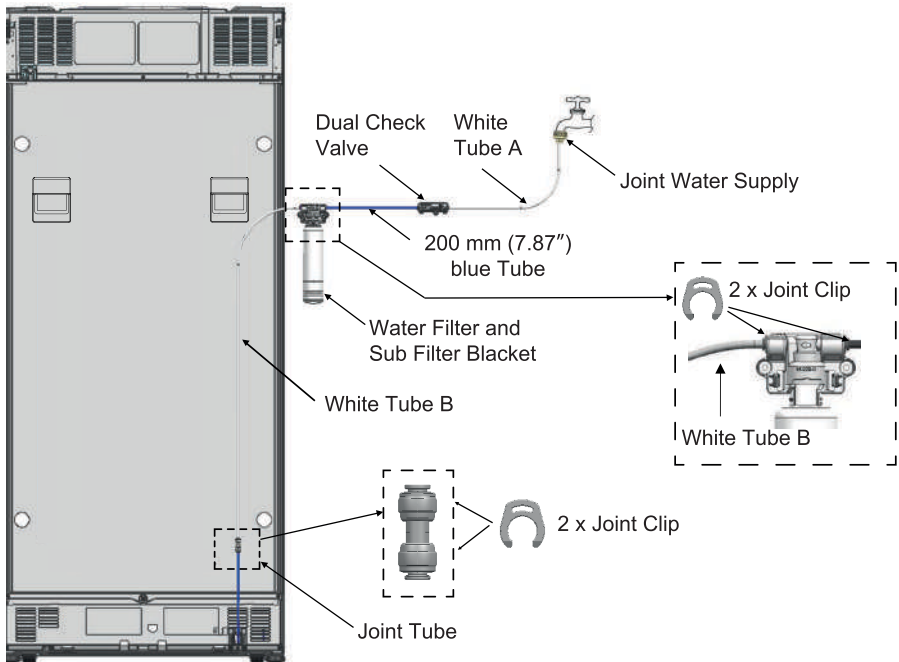

Figure 4: Designed Tubing layout

Step 9: Determine the mounting position for the Water Filter and fix the Sub Filter Bracket ⑥ with 2 pcs of Truss M4x25 ⑦ to a fixed surface. The direction to fix Sub Filter Bracket is referred to in Figure 5. Ensure the Water Filter is in a convenient location to access easily every 6 months for replacement. Ensure the clearance from the bottom of Water Filter is at least 50 mm to perform filter removal (Figure 6).

Insert Water Filter to Sub Filter Bracket by inserting the Filter Head of Water Filter to hooks of Bracket until get the “Click” sound when Water Filter and Sub Filter Bracket are locked into place.

Move Water Filter down about 90° until get the “Click” sound when Water Filter is firmly locked into.

We recommend fitting the Water Filter in a vertical orientation with the Filter Head at the top as in Figure 6.

This will ensure the performance of Water Filter and minimise water leakage during replacement of the filter.

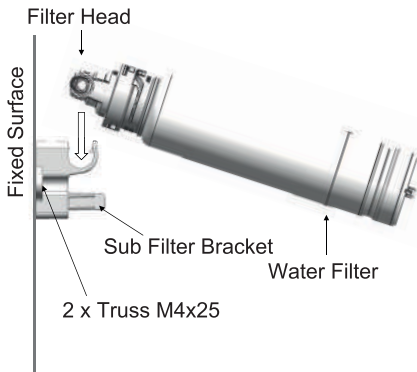

Figure 5: Sub Filter Bracket and Water Filter fixing direction.

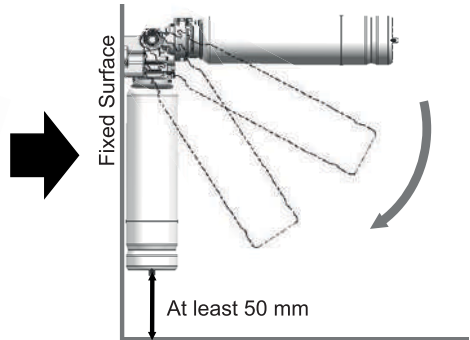

Figure 6: Water Filter usage setting.

※ After Water Connection System installation

- Check all connections carefully to prevent leaks.
- Switch on your refrigerator after finishing Water Connection installation.
- Allow at least 4 hours in continuous running for the refrigerator to cool down, in the condition of no food items inside and the doors are not opened.
- For the first time using Auto Ice making, please check the operation of Auto Ice Off mode (Page 29).

If Auto Ice Off mode is in operation, turn off this mode.

Activate Auto Ice Clean mode as the instruction in Page 29 to ensure the Ice tray is free from dust and eliminate unpleasant smells.

● **IMPORTANT!**

The first time you use your Water Dispenser, there will be a 1 - 2 minute delay while the tank fills. Please dispense continuously in about 30 seconds each time. Run through and discard approximately the first 3 liters of water, stopping intermittently to remove trapped air in the system.

Failure to do this will result in excessive dripping from your dispenser.

- **Step 6** is highly recommended to remove trapped air. If this step is skipped, please follow these below steps when using the Water Dispenser for the first time to avoid water dripping.
 - ① Press the Water Dispenser to dispense 4 liters of water.
 - ② Wait for 3 ~ 5 minutes before dispensing again.
 - ③ Dispense 4 liters of water then wait another 3 ~ 5 minutes.
 - ④ Dispense another 4 liters of water. Your Water Dispenser is ready to use.
- Please note that after a few days once installation is completed, a few drops may appear from the dispenser as the remaining trapped air is cleared.
- Water Dispenser is set for water to flow out in about 1 second delay to prevent water from flowing out when accidentally touching the lever of Water Dispenser.

Attention

- The noise of water supply system is generated while taking in water. This is normal.
- The Water Dispenser, when first used will generate noise in the door of the refrigerator. This is caused by the air being pushed through the check valve.
- Do not peel off the tape that fixed the Water Tube behind the refrigerator, peeling off may cause a loud noise when taking in water.

Parts Identification

Left door

Right door

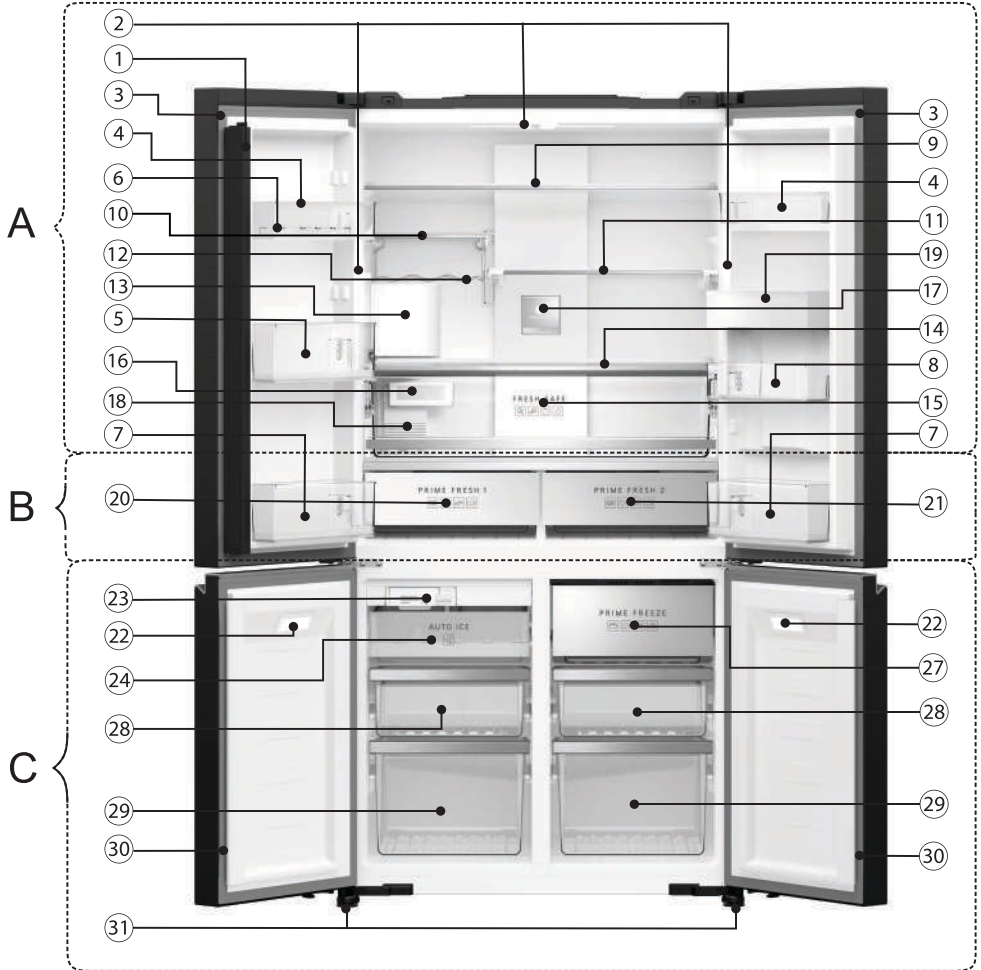

Parts Identification

A-Fridge compartment

① French Crossrail

The French Crossrail minimizes the gap between the left door and the right door of the refrigerator. If this French Crossrail is opened forward, put it back into place.

(Otherwise, the refrigerator doors cannot be closed fully, causing the refrigerator to lose cool air.)

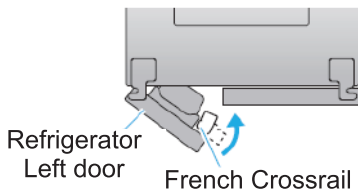

- ② LED of Fridge compartment (Quantity: 3 pcs)
- ③ Door gasket of Fridge compartment (Quantity: 2 pcs)
- ④ Small door shelf (Quantity: 2 pcs)
- ⑤ Large door shelf
- ⑥ Egg tray
- ⑦ Bottle shelf (Quantity: 2 pcs)
- ⑧ Utility shelf
- ⑨ Large glass tray of Fridge compartment
- ⑩ Small glass tray of Fridge compartment
- ⑪ Slide glass tray
- ⑫ Wine rack*
- ⑬ Cover Auto Ice water supply
- ⑭ Glass tray of Vegetable case
- ⑮ Vegetable case
- ⑯ Moisture control filter for vegetable case
- ⑰ nanoe™ X
- ⑱ nanoe™ X device
- ⑲ Shelf cover

*The position of the Wine rack is not fixed and changeable to the purpose of use.
(Refer to Page 32)

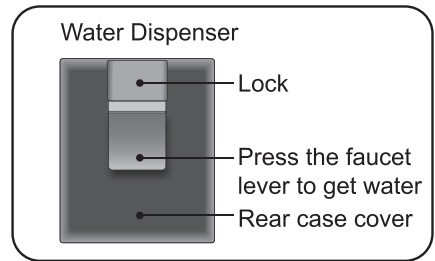

B-Prime Fresh case

- ⑳ Prime Fresh case 1
- ㉑ Prime Fresh case 2

C-Freezer compartment

- ㉒ LED of Freezer case (Quantity: 2 pcs)
- ㉓ Auto Ice maker
- ㉔ Ice box
- ㉕ Ice scoop
- ㉖ Customized divider
- ㉗ Prime Freeze case
- ㉘ Upper Freezer case (Quantity: 2 pcs)
- ㉙ Lower Freezer case (Quantity: 2 pcs)
- ㉚ Gasket door of Freezer compartment (Quantity: 2 pcs)
- ㉛ Adjuster bolts

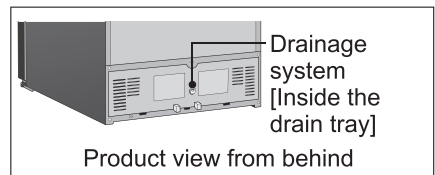
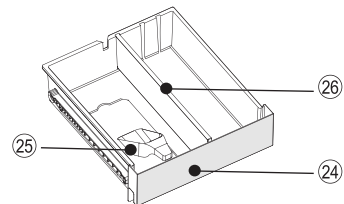

Operation Panel

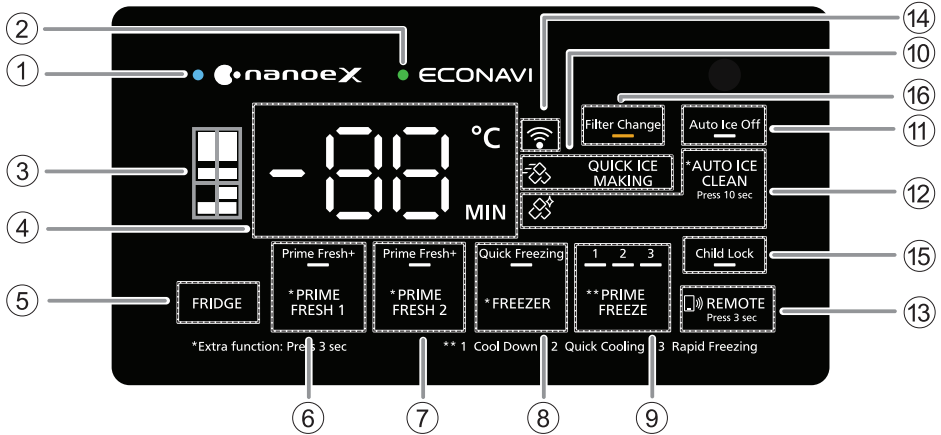

- ① Icon and LED of nanoe™ X: display the current status of nanoe™ X mode.
- ② Icon and LED of ECONAVI: display the current status of ECONAVI operation.
- ③ LED of compartments: the icon of the respective compartment will light up when the compartment is selected.
- ④ Temperature and time display area: display the temperature of Fridge compartment, Freezer compartment, Prime Fresh case 1, Prime Fresh case 2 and the time for modes of the Prime Freeze.
- ⑤ Temperature control button of Fridge compartment.
- ⑥ Temperature control button of Prime Fresh case 1 and LED of Prime Fresh+.
- ⑦ Temperature control button of Prime Fresh case 2 and LED of Prime Fresh+.
- ⑧ Temperature control button of Freezer compartment and LED of Quick Freezing.
- ⑨ Control button and LED for modes of Prime Freeze.
- ⑩ Control button and LED of Quick Ice Making.
- ⑪ LED of Auto Ice Off.
- ⑫ Control button and LED of Auto Ice Clean.
- ⑬ Control button of wireless LAN connection.
- ⑭ LED of wireless LAN connection.
- ⑮ LED of Child Lock.
- ⑯ LED of Filter Change.

Operation Panel

Remark

- On the Operation Panel: “*Extra function: Press 3 sec”, means that you need to press and hold the button beginning with “*” mark for 3 seconds when you want to start the extra functions.
- Under normal conditions, the Operation Panel light will turn off. When you press the buttons, the Operation Panel light will turn on. The Operation Panel light will turn off and all the buttons will not operate when the refrigerator door is opened.
- In summer, when the temperature is high, if you put uncooled food in the refrigerator or open/close the refrigerator doors repeatedly, the temperature inside will increase and the displayed value will be higher than the setting temperature. Therefore, it is necessary to reduce doors opening times.
- When first plugged in, the Operation Panel will display the introduction of modes and the temperature of compartments for about 10 seconds. Buttons will not be active during this period of time. After 10 seconds, the Operation Panel can be adjusted normally.
- The LED of Filter Change will turn on orange every 6 months to notify the recommended time to change the Water Filter Cartridge.
- When cleaning the door surface of refrigerator, lock the Operation Panel by Child Lock mode to prevent unintended adjustment to the button on Operation Panel, please refer to Page 29.
- When connecting to wireless LAN, 3 buttons: “Prime Fresh 2”, “Auto Ice Clean” and “Quick Ice Making” on the Operation Panel will not work. The others “Fridge”, “Prime Fresh 1”, “Freezer”, “Prime Freeze” and “Remote” will work for wireless LAN connection mode. Please complete or cancel the wireless LAN connection mode to use the Operation Panel normally. (Refer to Page 30)

Temperature Control





- Default setting temperature for Fridge compartment is 4 °C, Prime Fresh case 1 and Prime Fresh case 2 is -3 °C and Freezer compartment is -20 °C. The temperature setting for each compartment can be adjusted.
- The temperature setting range of the Fridge compartment is 1 °C ~ 7 °C, the Prime Fresh case is -5 °C ~ 4 °C (the temperature for soft freezing is -5 °C ~ -1 °C, and the temperature to use the Prime Fresh case as the Fridge compartment is 0 °C ~ 4 °C), the Freezer compartment is -23 °C ~ -15 °C.
- The temperature inside the refrigerator will vary depending on the ambient temperature, installation status, usage conditions and amount of food.
- Due to different testing methods and tools, the actual temperature may differ from the displayed temperature.
- This refrigerator is equipped with a processor to control the temperature inside the refrigerator. When the ambient temperature changes, the compressor runs or stops, the doors are opened or closed, the temperature inside the refrigerator and the temperature setting will have a slight difference.

■ Temperature setting instructions

1. Display the current temperature

Press the following icons to display the current temperature of these compartments: Fridge compartment, Prime Fresh case 1, Prime Fresh case 2, and Freezer compartment. The LED lights will indicate selected compartment and temperature when selected.

Temperature Control

Icon	Compartment	LED indicates position of the compartment	LED indicates temperature of the compartment
FRIDGE	Fridge compartment		4 °C
* PRIME FRESH 1	Prime Fresh case 1		-3 °C
* PRIME FRESH 2	Prime Fresh case 2		-3 °C
* FREEZER	Freezer compartment		-20 °C

2. Temperature setting

After pressing the icon of compartment (Fridge, Prime Fresh 1, Prime Fresh 2, Freezer) to display the current temperature, press again to start the temperature setting process. Then, LED indicates position of the compartment and LED indicates temperature of the compartment will flash.

Continue to press the icon of that compartment to select the desired temperature level. Each time the button is pressed, the temperature will increase by 1 °C within temperature setting range of the compartment. If the selection exceeds the compartment temperature range, the Operation Panel will display the temperature return to the lowest level in the above range.

3. Complete temperature setting

After completing the temperature setting, press another button to finish or wait for 5 seconds, the Operation Panel will save the setting that you have just made.

ECONAVI Operation

The refrigerator detects the opening and closing of the refrigerator door and the brightness around the refrigerator to control operations automatically to ensure maximum energy saving.^(*)

■ ECONAVI operation

- The refrigerator learns the lifestyle patterns of your family from door opening and time periods of infrequent use to maximize energy efficiency.
- The refrigerator learns your lifestyle patterns from the previous 3 weeks of use and uses that data from the 4th week onwards.
- The refrigerator performs the ECONAVI energy saving operation when it becomes dark around the refrigerator such as in the night.

■ Settings for enabling ECONAVI operation

- ECONAVI operation is enabled automatically when the temperature control for both the Fridge compartment and the Freezer compartment is set to 4 °C and -20 °C, respectively.
- ECONAVI operation does not operate if the “Quick Freezing”, “Prime Freeze” or “Quick Ice Making” mode is in operation.
- It is not possible to force start the ECONAVI mode.

Remark

^(*) The effectiveness of the ECONAVI mode is dependant on the ambient temperature, ambient brightness and the number of times the refrigerator door is opened and closed and the state in which food is stored.

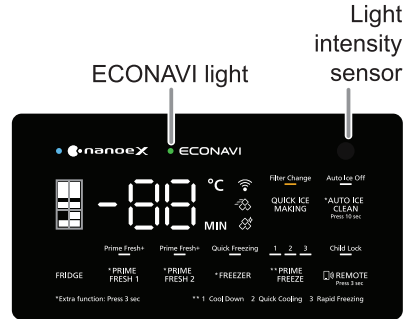

nanoe™ X

- A nanoe™ is a nano-sized ion particle coated with water particles. nanoe™ X are nano-sized electrostatic atomized water particles with 10 times the OH radicals of nanoe™.
- nanoe™ X will start when the refrigerator is plugged in and always run when the refrigerator is in use. However, nanoe™ X requires moisture when operating, the effectiveness of this mode will be reduced if the humidity inside the Fridge compartment is reduced (such as when storing a few of vegetables, or tubers).
- The nanoe™ X device may cause a small sound during operation.
- After the doors have been closed a long time, when open the doors of the refrigerator, it is possible to smell the odor of ozone generated during nanoe™ X operation, this is a normal phenomenon.

Quick Freezing

When “Quick Freezing” is set, the refrigerator will reduce the temperature quickly for better performance of preserving food.

■ How to operate the “Quick Freezing” mode



Light is on: Quick Freezing is operated.
Light is off: Quick Freezing is not operated.

- Press and hold the “Freezer” icon for 3 seconds to start the Quick Freezing. Then, the light below the “Quick Freezing” icon will turn on.
- If you want to stop the Quick Freezing operation immediately, press and hold the “Freezer” icon for 3 seconds until the light turns off.

Remark

- The “Quick Freezing” operation will stop automatically after running for 150 minutes and return to normal mode. (The light LED [Quick Freezing] turns off.)
- The flashing LED [Quick Freezing] means that the defrosting system is currently working. The “Quick Freezing” mode will start right after the defrosting operation is finished.
- The temperature of the Freezer compartment will return to its previous setting when the Quick Freezing mode ends.
- The following modes will be stopped when Quick Freezing is turned on: “Prime Fresh+”; “Quick Ice Making”; “Prime Freeze”.

Prime Fresh+

When “Prime Fresh+” is set, the Prime Fresh case will reduce the temperature quickly for better performance of preserving food.

■ How to operate the “Prime Fresh+” mode



Light is on: Prime Fresh+ is operated.
Light is off: Prime Fresh+ is not operated.

- Press and hold the “Prime Fresh 1” or “Prime Fresh 2” icon for 3 seconds to start Prime Fresh+. Then, the light below the “Prime Fresh+” icon will turn on.
- If you want to stop the Prime Fresh+ immediately, press and hold the “Prime Fresh 1” or “Prime Fresh 2” icon for 3 seconds until the light turns off.

Remark



- “Prime Fresh+” will stop automatically after running for 105 minutes (when the ambient temperature is 18 °C or less) or between 145 ~ 150 minutes (when the ambient temperature is higher than 18 °C) and return to normal mode. (The LED [Prime Fresh+] turns off.)
- The flashing LED [Prime Fresh+] means that the defrosting system is currently working. “Prime Fresh+” will start right after the defrosting operation is finished.
- The temperature of the Prime Fresh case will return to its previous setting when “Prime Fresh+” ends.
- The following modes will be stopped when Prime Fresh+ is turned on: “Quick Freezing”; “Quick Ice Making”; “Prime Freeze”.
- “Prime Fresh+” will not start when the temperature of the Prime Fresh case is being set at 0 °C ~ 4 °C.

Prime Freeze

Prime Freeze is a separate area located inside the Freezer compartment. This compartment is equipped with an individual fan system and high-class aluminum heat transfer plate, and modes to adjust the cooling time according to each food processing purpose in order to support the user in preparing dishes in a variety of way and save time.

■ How to operate Prime Freeze

- 1 Press the icon of the Prime Freeze compartment on the Operation Panel. Then, the LED indicates position of the compartment, the LED indicates mode 1-2-3^(*) and the LED indicates operating time^(**) of the Prime Freeze will turn on when selected.

Icon	Compartment	LED indicates position of the compartment	LED indicates mode 1-2-3	LED indicates operating time
** PRIME FREEZE	Prime Freeze		1 2 3 	 MIN

(*) LED indicates mode 1-2-3:

- If the previous setting has not run out of time, the light will display the previous setting mode.
- If there is no time left from the previous setting, all LED indicates mode 1-2-3 will turn off.

(**) LED indicates operating time:

- If the previous setting has not run out of time, the remaining minute value will be displayed.
- If there is no time left from the previous setting, the minute value will be displayed as "--".

- 2 If you continue to press the icon of the Prime Freeze compartment, the LED indicating the compartment position will flash. After this step, if the previous setting has not run out of time, the minute value will be cleared and displayed back to "--". Press the icon of the Prime Freeze until the desired mode is selected. Each time the button is pressed, the LED displays the operating time in each respective mode.

- 3 Complete the setting

After completing the temperature setting, press any other button to finish or wait for 5 seconds, the Operation Panel will save the setting that you have just made.

- 4 End mode

After the setting time of a mode running out, the Operation Panel will display the time back to "0" and there will be a notification sound. The notification sound will repeat every 2 minutes for 6 minutes, until you press the "Prime Freeze" icon on the Operation Panel or when the Freezer compartment door is opened. If you do not take food out immediately after the end of the mode, your food may be frozen more than desired.

■ Modes of Prime Freeze

Mode name	Display	Purpose of food processing	Mode (Unit: Minute)	Recommended type of food	Remark
Cool Down 1 Cool Down	1	Cooling down quickly the warm/hot food	3	<ul style="list-style-type: none"> • Rice (150 g) • Potato salad (150 g) 	<ul style="list-style-type: none"> - Do not cover the box with lid or food wrapper to ensure the effectiveness of Cool Down. If you are concerned about the smell of your food, you can use a lid or food wrapper to cover it, but the food may not be cold enough. - 5 minutes is the estimated time for 1 lunch box (about 150 g of rice) or 200 g of prepared food. If the amount of food is larger, it may take longer to cool down. - Quick Cooling can be used to cooling down over 200 ml of formula milk within 10 minutes. - After cooling down the formula milk with Cool Down, it is necessary to check the temperature of the formula milk before giving it to the baby.
			5	<ul style="list-style-type: none"> • Rice (300 g) • Potato salad (300 g) • Formula milk (100 ml) • Soup (150 ml) 	
Quick Cooling 2 Quick Cooling	2	Cooling food quickly to save time for preparing food and desserts.	10	<ul style="list-style-type: none"> • Curry (200 g) • Fish (100 g) • Pudding (2 pieces) • Jelly (2 pieces) 	<ul style="list-style-type: none"> - For ingredients that need to be marinated or seasoned such as meat, fried/grilled fish, soy-marinated eggs, etc., put the ingredients and spices into sealed containers/bags. The ingredients will burst with flavor during the cooling process. - For fresh meat, fish, and shrimp that may be difficult to slice/cut, the slicing/cutting will be easier after placing them in Quick Cooling mode. - Use aluminum or metal cups for jelly or desserts. With ceramic or porcelain containers, food may not be cold enough. - This mode can be used to cool beverages quickly.
			15	<ul style="list-style-type: none"> • Curry (400 g) • Chicken drumstick (250 g) • Pudding or Flan (4 pieces) • Jelly or cakes made from gelatine (4 pieces) 	
Rapid Freezing 3 Rapid Freezing	3	Freezing rapidly prepared dishes to ensure the preservation of prepared foods and save time for every day cooking.	45	<ul style="list-style-type: none"> • Beef (150 g) • Steamed vegetables (1 bunch of broccoli) • Vegetables (250 g of sliced cabbage) • Fried chicken (250 g for 2 people) • Sherbet (300 ml) • Bread (2 pieces) 	<ul style="list-style-type: none"> - Cover fresh food and steamed vegetables with food wrapper, freezer bags or cover with tight lids. - Fried foods (e.g. fried chicken, fried shrimp/squid, spring rolls,...) should be placed onto an aluminum tray and use "Rapid Freezing". After freezing the food, put them into freezer bags or containers for storage. - This mode can be used to freeze some fruits such as strawberries, lychees, berries,... for long-term preservation.
			60	<ul style="list-style-type: none"> • Jellied meat (350 g) • Half of a chicken (500 g) • Beef (250 g) • Cubed ice (1 tray) 	

Prime Freeze

Remark

- Always place food on the aluminum heat transfer plate for the best effectiveness of cooling.
- When hot or wet food is placed on the aluminum heat transfer plate without a lid or food wrapper, the surface of the food may be frozen and the inside of Freezer compartment may be frosted. If you are worried, please use lids or food wrapper.
- If cooked food is still at a high temperature, it should be cooled down to about 70 °C before putting in the Prime Freeze case.
- Leaving a glass bottle or can inside the compartment may pose a risk of broken, cracking, or damage.
- Do not place the food which is higher than the height of the Prime Freeze case to avoid the risk that the Prime Fresh case does not close completely, causing frost and damaging food or food containers in the room.
- Do not touch the metal food container directly with wet hands, as there is a risk of frostbite.
- During the operation of Prime Freeze:
 - ECONAVI operation will be stopped.
 - The noise from the fan will be louder.
 - The power consumption will be higher than normal.
 - If Quick Ice Making, Quick Freezing, Prime Fresh+ are set, Prime Freeze will be stopped.
 - The flashing of [Prime Freeze] LED means that the defrosting system is currently working. “Prime Freeze” will start right after the defrosting operation is finished. This is a normal phenomenon.
- When Prime Freeze is not in use, this case can also be used as any other position in the Freezer compartment.
 - Small foods can be stored for easier finding.
 - The temperature in this room may be higher than the temperature in the entire Freezer compartment. For long-term preservation, please transfer food to the Freezer compartment.
- To adjust the time of the modes of the Prime Freeze, refer to the application “Panasonic SmartApp+”. The application allows to adjust the time by minute, create and save the Prime Freeze modes fluently used in My list section.

Quick Ice Making

When setting Quick Ice Making, the refrigerator will increase its capacity to reduce ice making time.

■ How to operate Quick Ice Making



Light is on: Quick Ice Making is operated.
Light is off: Quick Ice Making is not operated.

- Press the “Quick Ice Making” icon twice in a row to start Quick Ice Making. Then, the icon of Quick Ice Making will turn on.
- When you want to stop Quick Ice making, press the “Quick Ice Making” icon once until the light turns off.

Remark

- The following modes will be stopped when Quick Ice Making is turned on:
 - Quick Freezing
 - Prime Fresh+
 - Prime Freeze
 - Auto Ice Off

Auto Ice Off and Auto Ice Clean

When the refrigerator is in operation, the Auto Ice making mode will automatically operate without any setting. When setting the Auto Ice Off and Auto Ice Clean mode, the refrigerator will stop the Auto Ice making and clean the ice maker automatically.

■ How to operate the Auto Ice Off mode



Light is on: Auto Ice Off is operated.
Light is off: Auto Ice Off is not operated.

- Press and hold the “Auto Ice Clean” icon for 3 seconds to start the Auto Ice Off. Then, the LED below the Auto Ice Off icon will turn on.
- When you want to restart the Auto Ice making, press the “Auto Ice Clean” for 3 seconds. Then, the LED of the Auto Ice Off will turn off.

Note

- When the Auto Ice Off mode is on, Quick Ice Making, if active, will be stopped.

■ How to operate the Auto Ice Clean mode



Light is on: Auto Ice Clean is operated.
Light is off: Auto Ice Clean is not operated.

- Press and hold the “Auto Ice Clean” icon for 10 seconds to enable the Auto Ice Clean mode. At that time, the LED of Auto Ice Clean will turn on.
- At the end of the Auto Ice Clean process, the refrigerator will make a notification sound.

Remark

- When Auto Ice Clean is operating, it cannot be stopped / disabled midway and other modes cannot be controlled by “Panasonic SmartApp+” application.

For details on the cleaning operation of Auto Ice maker, please refer to Page 37.

Child Lock

When setting the Child Lock mode, the Operation Panel will disable the interaction to adjust temperature and modes in order to prevent unintended adjustment by children.

■ How to operate Child Lock



Light is on: Child lock is operated.
Light is off: Child lock is not operated.



- Press “Remote” icon and “Prime Freeze” icon at the same time for 3 seconds to start the Child Lock mode. Then, the light below “Child Lock” icon will turn on.
- When you want to stop the Child Lock mode, press “Remote” icon and “Prime Freeze” icon at the same time for 3 seconds. Then the light below the “Child Lock” icon will turn off.

Remark

When setting the Child Lock mode, the Water Dispenser will be locked.

Filter Change

Filter Change

- The LED of Filter Change will be turned on in orange LED after 6 months of operation (180 days or more of power supply or water inlet valve is left open).
- This orange LED will be continuously light on until finish changing the Water Filter and reset it.

How to reset the LED of Filter Change



- While the LED of Filter Change is displayed, press and hold the “Quick Ice Making” icon and the “Auto Ice Clean” icon at the same time for 3 seconds. Then, the orange LED will be turned off.
- When the LED of Filter Change turns off, data of power supply and water valve open days will be cleared. It will reset to a new counting round for the next 180 days of Filter changing.

Remark

- It is necessary to change the Water Filter Cartridge right when the LED of Filter Change light on, to ensure the quality of water supply and prevent any risk of illness or poisoning damaged to your health.
- If the LED of Filter Change is displayed but you cannot immediately replace the Water Filter, do not reset the LED of Filter Change until the new Water Filter has been installed. Instruction for changing new Water Filter please refer in Page 38.

Wireless LAN

■ Wireless LAN connection mode

Wireless LAN connection mode will connect the refrigerator to a wireless LAN router. The user connects the refrigerator to wireless LAN router by using wireless LAN connection mode. It is used for the first time buying the refrigerator, or changing the refrigerator circuit board, or changing the wireless LAN router information (network name, password), or changing the owner of the refrigerator.



Flashing light: Wireless LAN connection is in progress.
Lights on: Wireless LAN connected successfully.
Lights off: Wireless LAN connection mode does not work.

- Press the “Remote” icon for 3 seconds to start the wireless LAN connection mode. When the wireless LAN connection mode is active, the LED of wireless LAN connection mode will flash. After successfully completing the connection process, the LED of wireless LAN connection mode will turn on.
- When you want to cancel the wireless LAN connection mode, press and hold the “Remote” icon for 3 seconds. At that time, the LED of wireless LAN connection will flash.

Wireless LAN

■ Power setting of wireless LAN module



- When the power of the wireless LAN module is off, press and hold the “Remote” and “Freezer” icons at the same time for 3 seconds to turn on the power of the wireless LAN module. “on” is shown for 5 seconds on the Operation Panel. Then, the power of the wireless LAN module is turned on.
- When the power of the wireless LAN module is on, press and hold the “Remote” and “Freezer” icons at the same time for 3 seconds to turn off the power of the wireless LAN module. “oF” is shown for 5 seconds on the Operation Panel. Then, the power of the wireless LAN module is turned off.

Remark

- When the wireless LAN connection mode is enabled, the wireless LAN module is automatically powered on by the refrigerator and the refrigerator will be connected to network.
- If you do not use the wireless LAN connection, please turn off the power of the wireless LAN module in order to save power and avoid unexpected settings from another mobile device.
- If you change the wireless LAN router information, the following steps should be taken:
 - Delete the router information that was previously stored on the refrigerator by:
 - ① Press and hold the “Remote” icon for 3 seconds, then the Operation Panel displays “C2”.
 - ② Press and hold the “Freezer” and “Prime Freeze” icons at the same time for 3 seconds, the refrigerator emits a notification sound, and the Operation Panel displays “In”.
 - ③ The information will be deleted when the Operation Panel no longer displays “In” and the light LED of wireless LAN flashes.
 - Reconnect to router using wireless LAN connection mode. Then, open the “Panasonic SmartApp+” application on your mobile phone and follow the instructions on the application.

■ The LED operation of Wireless LAN

- When the wireless LAN module is powered off, the LED of wireless LAN is turned off.
- When the wireless LAN module is on and the wireless LAN is connected, the LED of wireless LAN is turned on.
- When the wireless LAN module is powered on and the wireless LAN is not connected, the LED of wireless LAN flashes once every 0.5 seconds.
- When the wireless LAN module turns on and the communication with the wireless LAN module fails, the LED of wireless LAN flashes once every 0.1 seconds.
- After restarting the wireless LAN module, the LED of wireless LAN flashes to find and reconnect with the previously saved wireless LAN network.

Fridge compartment

The temperature range of the Fridge compartment is 1 °C ~ 7 °C

If the temperature of the Fridge compartment is set to 1 °C during a long period of time, your food may be frozen.

How to use Slide glass tray

Slide the front-half glass tray to the back, then you can store taller items with out needing to store lying down.

The position of the Slide glass tray can be changed to place more items depending on the purpose of use.

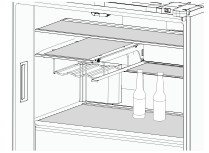
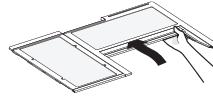

Please refer to Page 42 for how to remove the Slide glass tray.

Vegetable case

The Vegetable case is equipped with a large-capacitor and the guide rail with a maximum opening angle, making it easier to take out food and increasing its load-bearing capacity, allowing the user to gently pull the case out with just one hand. The Moisture control filter will control the humidity inside the vegetable case, helping the vegetables retain moisture and stay fresh.

Note

- Due to high humidity, water drops may appear on the vegetable case. Wipe droplets off with a soft cloth.
- Do not place food higher than the height of the vegetable case to avoid the risk that the vegetable case does not close completely, causing frost and damaging vegetables and fruits.

How to use the Wine rack

The wine rack can be flexibly placed in different positions in 3 ways:

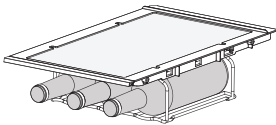

Hang the Wine rack under the small glass tray of Fridge compartment

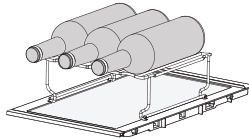

Put the Wine rack on the small glass tray of Fridge compartment

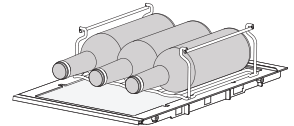

Put the Wine rack on the surface of glass trays of Fridge compartment

- Secure the pins of the Wine rack to the tabs of the Small glass tray of Fridge compartment.
- Make sure the Wine rack does not extend pass the protruding lug of the glass trays, to avoid movement when opening / closing the refrigerator door.

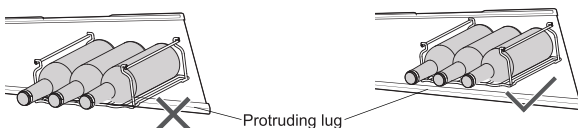
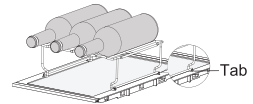

- Noise may occur when the Wine rack is moved on the glass trays of the refrigerator. This is a normal phenomenon.

How to remove the Wine rack, please refer to Page 45.

How to use the Water dispenser

With the Water Dispenser, you can get cold water without opening the refrigerator door.

■ How to get water

- ① Push the lock upward until it touches the top edge.
- ② Keep the cup straight and gently push the lever to get water.

Attention

- Before using Water Dispenser, the Water Connection system must be installed correctly. Refer to the Installation instruction in Page 12 ~ Page 18 for details.
- When used for the first time, please run through and discard the first 3 liters of water, stopping intermittently to remove trapped air in the system. Failure to do this will result in expensive dripping from your dispenser.
- It will take about a second for the water to dispense when the lever is pushed. The purpose of this is to limit the water flow in case of accidentally touching the lever.
- After taking enough water, slowly take the cup out to avoid the water leaking.
- Use a clean cloth to dry if any water spills out.
- When you need to lock the Water Dispenser, pull the lock downward until it touches the bottom edge and the red line can be seen. If it is not necessary to lock the Water Dispenser, skip this step.
- Water may not cool if dispensing continuously by Water Dispenser for a period longer than 2 minutes.

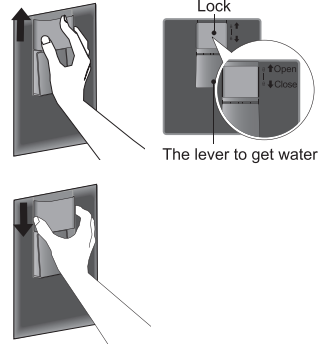

Tips for food preservation

■ Do not stuff too many food items

When there are too many food items and there is no space for cool air circulation inside the refrigerator, the cooling capacity will be affected. Provide sufficient space between foods.



Not wasting cool air inside the refrigerator is the key to keeping food fresher for longer!

■ Do not block the cool air outlet with food items

If the cool air does not spread into every corner of compartments, then the interior will not be sufficiently cooled and more electricity will be consumed. Therefore, food should not be placed in front of the cooling air vents* and block the air circulation.

*The cooling air vents are located on the duct inside the Fridge compartment.

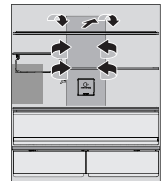

Prime Fresh case

The temperature in the Prime Fresh case can be selected as below:

- The temperature for soft freeze is $-1\text{ }^{\circ}\text{C} \sim -5\text{ }^{\circ}\text{C}$.
- The temperature to use the Prime Fresh case as the Fridge compartment is $0\text{ }^{\circ}\text{C} \sim 4\text{ }^{\circ}\text{C}$.

When using the refrigerator with 2 independent Prime Fresh cases, the temperature can be adjusted according to your usage.

The default temperature setting of Prime Fresh case is $-3\text{ }^{\circ}\text{C}$.

Using Prime Fresh case

Approx. $-5\text{ }^{\circ}\text{C} \sim -1\text{ }^{\circ}\text{C}$

- This compartment is suitable for storing fresh food, such as meat or fish. Compared to storing in the Fridge compartment, the storage life of meat or fish is extended.
- The preservation of food with 2 independent Prime Fresh cases helps to reduce the influence of odors and flavors of different foods, by adjusting the appropriate mode for each type of food, such as raw food for Prime Fresh case 1, and cooked food for Prime Fresh case 2.
- When food is too frozen.
Sliced raw fish or meat may be too frozen. Set the temperature to higher than $-3\text{ }^{\circ}\text{C}$ to prevent food from over frozen.
- When food is not partially-frozen.
Depending on the type of food, such as a large block of meat or a large fish, or the food fullness of the case, the storage conditions, and the ambient temperature, food may not be partially frozen as it intended. In this case, then set to the lowest temperature of $-5\text{ }^{\circ}\text{C}$.
- To reduce the effect of food being over-frozen or not freezing as desired, you can put the similar sized foods in the same Prime Fresh case and adjust the temperature accordingly.
- Do not overstock the case with too many food items. When there are too many food items and there is no space for cool air circulation inside the refrigerator, the cooling capacity will be affected. Provide sufficient space between foods inside Prime Fresh case.
- When storing food in large amounts, e.g. a large block of meat, a large fish, or a chicken, it is advisable to place the food at the center of the Prime Fresh case to optimize the cooling performance.
- When the temperature of the Prime Fresh case is set at $0\text{ }^{\circ}\text{C} \sim 4\text{ }^{\circ}\text{C}$, the Prime Fresh+ mode will not operate in order to prevent food spoilage.
- When opening the Prime Fresh 2 for food storage, please open both doors of the Freezer compartment. When only the right Freezer compartment door is opened, the Prime Fresh case 2 cannot be pulled out.
- Do not block the cool air outlet with food items inside the Prime Fresh case.
If the cool air does not spread into every corner of Prime Fresh case, then the interior will not be sufficiently cooled and the food may be affected.
Therefore, food should not be placed in front of the Cooling air guide (on the Prime Fresh case 1 and Prime Fresh case 2) to prevent blocking the air circulation inside the compartment.

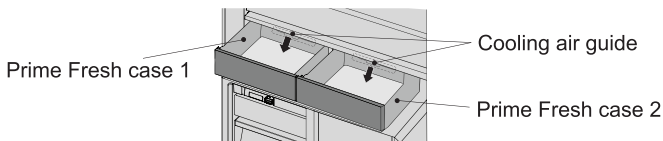

Freezer compartment

Storing frozen food, cooked meals and freezing food by Prime Freeze case.
The temperature range of the Freezer compartment is -23 °C to -15 °C

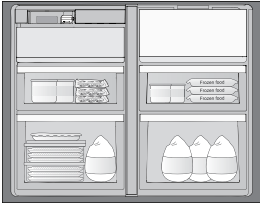

Three tips for freezing food and locking in the flavour

1. Freeze thin and small items of food quickly
2. Fully sealed
3. Do not refreeze

To make ice

- Auto Ice making will be automatically activated when refrigerator in operation and the Water Connection system is installed correctly.
Details for installation of Water Connection system refer in Page 12 ~ Page 18.
- Ice could be made in approx. 2 hours, with the temperature in the Fridge compartment is 4°C, Prime Fresh case 1 and Prime Fresh case 2 is -3°C, and Freezer compartment is -20°C.

How to make ice quickly

■ In the “Quick Ice Making” mode, the ice making speed will be increased.

Ice can be made within 90 minutes^(*) at the quickest.

Remark

- After about 6 hours, the refrigerator will automatically return to normal Auto Ice making mode.
- The flashing of [Quick Ice Making] LED means that the defrosting system is currently working. “Quick Ice Making” will start right after the defrosting operation is finished.
- In Quick Ice Making, energy consumption increases more than usual.
- ECONAVI operation does not work during the setting of “Quick Ice Making”.

^(*) Ambient temperature of 20 °C, the temperature of the Fridge compartment, the Prime Fresh case 1 and Prime Fresh case 2, and the Freezer compartment are 4 °C, -3 °C -3 °C and -20 °C, respectively.

Freezer compartment

To use the Auto Ice maker in comfort



Please use only drinking water for Auto Ice making.



Do not put liquids such as the following into the Water tank.

(These liquids may damage the Auto Ice maker).

The hardness of water must be 100 mg/L or less.



Drinking water



Juice, etc.



Sports drinks



Carbonated beverages



Hot water

Tips

- The hardness of water must be 100 mg/L or less. The minerals may appear as white floating particles. They are not harmful.
- When using the Auto Ice maker for the first time, odor or dust may be on the Ice tray, etc. Please throw away the first lot of ice.
- Remember to regularly use the Auto Ice Clean function of the Auto Ice maker. (Page 29)

Attention

When the Ice box is full and the ice cubes touch the ice detection lever, the ice making will stop automatically.

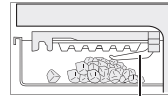

Ice detection lever

The pile of ice cubes will touch the ice detection lever. (Then, the Auto Ice making will stop).

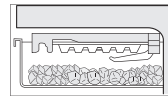

Distribute the ice cubes evenly inside the Ice box for making more ice.

Request

- Do not pour water directly into the Ice box to make ice. (Otherwise, the Ice box may be broken).
- Do not put food or other things into the Ice box. (Otherwise, the amount of ice cannot be correctly detected and Auto Ice making may be stopped or the Ice box cannot be pulled out.)

Ice maker cycle time will be longer in the following cases.

- The first time using the refrigerator. (It will take at least 24 hours since the Auto Ice making function only starts after the inside of the refrigerator is cool enough).
- When the refrigerator doors are frequently opened.
- When the refrigerator doors are ajar.
- When a large amount of food is stored at once.
- When the ambient temperature is low during winter or high during summer.
- When a power failure occurs.

How to clean the Auto Ice Maker

When using for the first time or when not being used after a long time, the Ice tray and Ice box may smell unpleasantly or collect dust. Remember to process to clean the Ice maker before start to make ice.

After selecting the Auto Ice Clean mode, water will be automatically poured into the Ice tray and water supply pipe 3 times (for about 2 minutes) to drain the water.

When selecting the ice maker cleaning mode, make sure the Water Connection system is installed correctly (Page 12 ~ Page 18).

- 1 Pull out the Ice box, remove all ice cubes from the Ice box (after the ice cubes are fully formed), and then install the Ice box back.
- 2 Check the Water Connection system is installed correctly and the water supply valve is opened.
- 3 Select the Auto Ice Clean mode (Page 29).
 - At the same time, the refrigerator will sound a notification and begin to clean the ice maker.
 - During the cleaning process, the sound cannot be turned off.
 - After the beeping sound to inform the completion of the cleaning process, the icon of the Auto Ice Clean mode on the Operation Panel will turn off, the ice maker cleaning process will end and the Auto Ice making will be started.
- 4 Pull out the Ice box from the Freezer compartment, throw away the water in the Ice box and wipe the water off.

If you do not clean all water on the Ice box, the Ice box may be damaged.

How to turn off Auto Ice maker

You can enable/disable the Auto Ice making mode according to your needs.

■ Turn off Auto Ice making

- 1 Choose the Auto Ice Off mode, the icon of the Auto Ice Off mode on the Operation Panel will turn on and the refrigerator will stop making ice (Page 29).
- 2 When you want to continue making ice automatically, please choose the Auto Ice Off mode, and the icon of the Auto Ice Off mode on the Operation Panel will turn off (Page 29).

■ Turn off Auto Ice making for a long period of time

- 1 Turn on Auto Ice Off mode and remove all ice cubes from the Ice box.
- 2 Clean the Ice box; dry and put it back in its place.
- 3 When using again, please turn off Auto Ice Off mode and the Auto Ice system will automatically make ice.

■ When transporting the refrigerator

- 1 Turn on Auto Ice Off mode and remove all ice cubes from the Ice box.
- 2 Choose the Auto Ice Clean mode, the icon of Auto Ice Clean mode on the Operation Panel will turn on and the refrigerator will start cleaning the ice maker. (At this time the ice cubes and water in the process of making ice will fall into the Ice box)
- 3 The cleaning process will stop after 2 minutes. Take out the Ice box and empty the ice cubes and water in the Ice box.
- 4 Clean Ice box; dry and put it back in its place.

How to use Ice box

Use a Customized divider to increase ice storage space, and match your ice storage needs.

- Manually lift the Customized divider off the track, and move it to another desired position.
- Use the Ice scoop when removing ice from the Ice box.

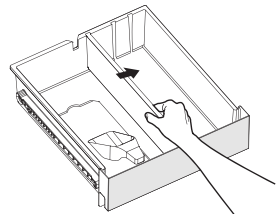

Water Filter Cartridge Installation and Replacement

The Water Filter Cartridge is recommended to be changed after 6 months of operation to ensure the quality of water supply and prevent any risk of illness or poisoning damage to your health.

Please change Water Filter Cartridge to a new one when the LED of Filter Change on Operation Panel turns on and is orange. (Page 21)

To change the Water Filter, follow these steps:

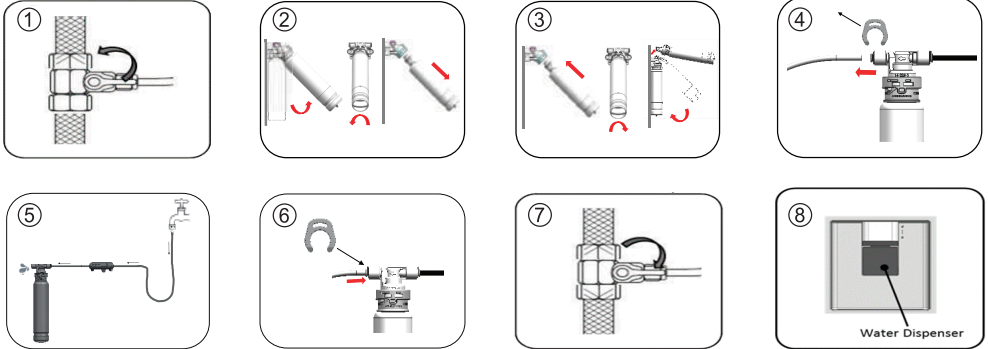

- ① Shut off the main water supply valve to the refrigerator to replace the Filter Cartridge.
- ② Lift up the Filter (less than 90 degrees), turn the Cartridge quarter of a turn to the left and take it out of the Filter Head.
- ③ Remove protective cap on Filter Cartridge, then insert the new Filter Cartridge into the Filter Head, turn it quarter of a turn to the right until it stops, and take the new Filter Cartridge with the Filter Head out of Sub Filter Bracket to outside.
- ④ Temporary stop the connection of Water Filter and refrigerator by disassembling the white Tube B out of the new Water Filter.
- ⑤ Aim the new Water Filter into a bucket, turn the water supply tab on and run the water through at least 12 liters of water. Once complete, turn off the water supply tab. Purpose of these actions is to flush the new Water Filter of any trapped air, avoiding water dripping.
- ⑥ Reconnect "Tube B" to Water Filter. Note to firmly fix "Tube B" with the Joint Clip. Insert new Water Filter back to the Sub Filter Bracket.
- ⑦ Turn on main water supply valve to the refrigerator.
- ⑧ Reset LED of Filter Change on Operation Panel and run water through the Water Dispenser for approximately 3 liters to purge the system and to check for leaks at all water connection points in the first two or three hours after installation. Re-check after 24 hours to ensure connection is watertight. If the connection is leaking, contact a licensed plumber.

Attention

Step ⑤ is highly recommended to remove trapped air. If this step is skipped, please follow these below steps in the first time using Water Dispenser after replacing the new Water Filter to avoid water dripping:

- Press the Water Dispenser to dispense 4 liters of water.
- Wait for 3 ~ 5 minutes before dispensing again.
- Dispense 4 liters of water then wait another 3 ~ 5 minutes.
- Dispense another 4 liters of water. Your Water Dispenser is ready to use.

Note

- The Water Filter system is tested and certified by NSF International against NSF/ANSI Standards 42, 53, 401 in System Model ARBHBA300020 for reduction claims specified on the Performance Data Sheet included with the Water Filter.
- Do not use with water that is microbiologically unsafe or of unknown quality without adequate disinfection before or after the system.
- Systems certified for cyst reduction may be used on disinfected water that may contain filterable cyst.
- For cold water only.
- NSF/ANSI Standard 53 certified to reduce cysts over 99.99% such as *Cryptosporidium* and *Giardia* by mechanical means. The testing was performed under standard laboratory conditions, actual performance may vary.
- The system and installation shall comply with applicable state and local regulations.
- Systems must be installed and operated in accordance with manufacturer's recommended procedures and guidelines.
- Spent adsorption media will not be regenerated and used.
- Do not install the Water Filter in an area of direct sunlight.
- Do not install the Water Filter in an area of the wall where there may be electrical wires and/or water supply pipes.
- To maintain proper filtration, replace the Filter approximately every 6 months.
- The System conforms to NSF/ANSI 42, 53, 401 for the specific performance claims as verified and substantiated by test data.
- Water will continue to drip from the dispenser for a few more days after installation to clear remaining trapped air in the dispenser. Dry it by cloth.

How to clean the Refrigerator

Before cleaning or conducting maintenance, please ensure that the power plug has been disconnected from the power outlet. Do not connect or disconnect the power plug with wet hands. When the plug is disconnected, leave it for 7 minutes before plugging again. If not, the compressor may not work.

Clean the refrigerator immediately after it is stained!

Wipe off stains on the interior surfaces quickly before they harden. In particular, cooking oil or lard may cause plastic to crack and citrus juice may cause the refrigerator to become discolored. When stains cannot be removed easily, wipe them with a cloth lightly soaked in neutral kitchen detergent. Then, wipe with a cloth lightly dipped in water.



Rub the door surface with a soft damp cloth.



Clean the detachable items occasionally.

Clean the ice tray once a week. As a guide, remove the trays, door shelves, etc. and wash them by immersing them in lukewarm water every three months.



Clean the door gasket at least once a month.

Clean by wiping with a soft damp cloth. Lubricated gel has been applied to the door gasket on the hinge side of the refrigerator, be careful not to wipe it off.

Point where lubricated gel was applied



Note

The door gasket is replaced by an authorised service agent. If the door gasket comes off while cleaning, it can be pushed back into the groove.

Request

Do not use the following items for cleaning. (Otherwise, the surface will be scratched or corroded.)



Kitchen detergents
(They crack plastic!)



Cleanser or soap powder



Benzene, thinner, alcohol, acid, petroleum



Scrubber



Hot Water

Door shelf/ Bottle shelf**Once every 3 months****■ Removing**

- ① Lift it upward, alternating between the right and left side.

■ Attaching

- ② Placing it on both supporters, and then press until it reaches the end of supporters.

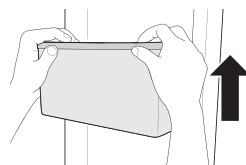
**Remark**

Shelf cover is not designed to remove for cleaning.
In case cleaning is required, please contact Panasonic service center.

Tray**Once every 3 months****■ Removing**

- ① Lift up the back of the tray and pull it forward. Once the protrusions of the tray are unhooked from the rails, tilt the tray and remove it.

**■ Attaching**

- ② Push the tray until it reaches the end lock.

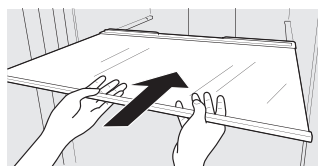
**Remark**

- To easily take out the glass trays from the refrigerator, please remove Door shelves and Bottle shelves first.
- The Glass tray vegetable case is cleaned by directly cleaning inside the refrigerator. (Due to its fixed design.)
- In case of attaching the tray and it does not lock, make sure that you did not attach it into the wrong tray.
- Trays made of glass are heavy.
Please handle them with care so that they do not fall and cause any damage or injury.
For attaching trays, hold them with the protrusion side down and firmly insert.

How to clean the Refrigerator

Slide glass tray

Once every 3 months

If the position of the Slide glass tray is in line with the Small glass tray of Fridge compartment:

■ Removing

- 1 Separate the joint between the Slide glass tray and the Small glass tray of Fridge compartment.
- 2 Lift up the underside of the Small glass tray of Fridge and pull it out from the left groove of the mount to the front. Once the protrusions are unhooked from the rails, tilt the tray and remove it.
- 3 Lift up the underside of the Slide glass tray and pull it out from the right groove of the mount to the front. Once the protrusions are unhooked from the rails, tilt the tray and remove it.

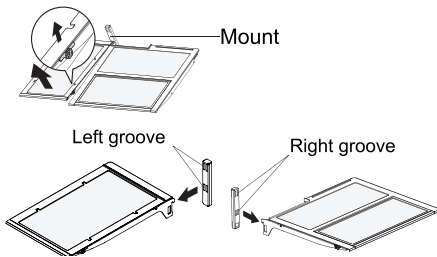

■ Attaching

- 1 Lift up the underside of the Slide glass tray and push into the right groove of the mount.
- 2 Lift up the underside of the Small glass tray of Fridge compartment and push into the left groove of the mount.
- 3 Fix the joint between the Slide glass tray and the Small glass tray of Fridge compartment.

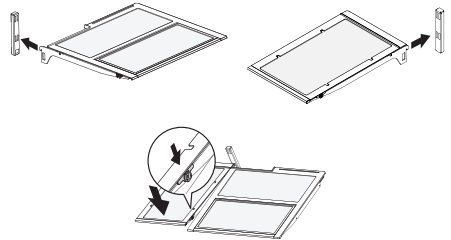

If the position of the Slide glass tray is not in line with the Small glass tray of Fridge compartment:

■ Removing

Lift up the underside of the Slide glass tray and pull it out from the right groove of the mount to the front. Once the protrusions are unhooked from the rails, tilt the tray and remove it.

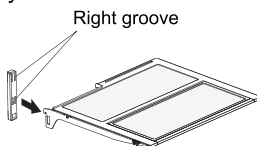

■ Attaching

Lift up the underside of the Slide glass tray and push into the right groove of the mount.

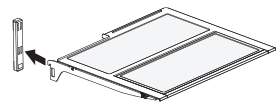

Remark

- To easily take out the Slide glass tray from the refrigerator, please remove Door shelves and Bottle shelves first.
- Trays made of glass are heavy. Please handle them with care so that they do not fall and cause any damage or injury. For attaching trays, hold them with the protrusion side down and firmly insert them.

※ Vegetable case



■ Removing

- 1 Fully open both doors of the Fridge compartment.
- 2 Remove the Utility shelf ⑧ and Large door shelf ⑤ (According to Parts Identification in Page 19, 20) before removing the Vegetable case.
- 3 Pull the case forward until it reaches the end and gently lift the front of the case to remove it completely.

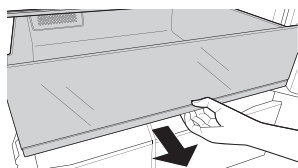

■ Attaching

- 1 Insert the case into the shelf.
- 2 Gently lift the case and push forward until it reaches the end.
- 3 Install Utility shelf ⑧ and Large door shelf ⑤ into.

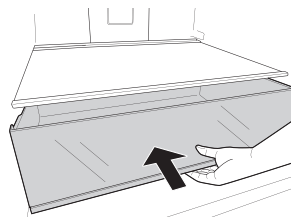

※ Freezer cases

Skip the steps of removing and installing the Utility shelf ⑧ and Large door shelf ⑤. Remove and install Freezer cases in steps same as Vegetable case.

Moisture control of Vegetable case

Once every 3 months

- 1 After pulling out the Vegetable case, the Moisture control is located at the back of the Vegetable case.
- 2 Slide the Moisture control upward to remove it.

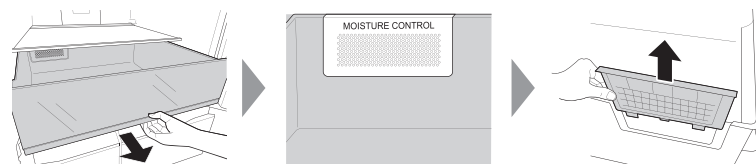

Remark

- After cleaning by water, wipe it or let it dry.
- For tough stains, dilute (neutral) kitchen detergent, and gently wash with a soft toothbrush, then rinse thoroughly with water.

How to clean the Refrigerator

Prime Fresh case

Once every 3 months



■ Removing

- 1 Fully open both doors of the Fridge compartment.
- 2 Remove the Bottle shelf ⑦ (According to Parts identification in Page 19, 20) before removing the Prime Fresh case.
- 3 Pull the case forward until it reaches the end and gently lift the front of the case to remove it completely.

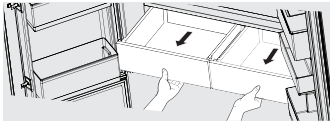

■ Attaching

- 1 Put the case into the shelf.
- 2 Gently lift the case and push forward until it reaches the end.
- 3 Install the Bottle shelf ⑦ into.

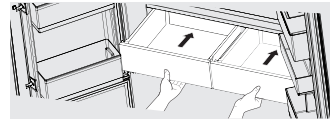

Prime Freeze case

Once every 3 months

■ Removing

- 1 Pull out the Prime Freeze case completely.
- 2 Lift the case, tilt it, and lift it out of the compartment diagonally.

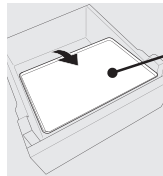
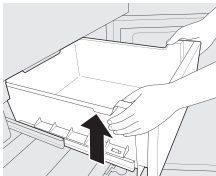

Aluminum heat transfer plate
(Note that the aluminum plate can be easily scratched and damaged)

■ Attaching

Pull out the Prime Freeze case, lift the back of the case and hook along the inner grooves until it matches and touches the end point.

Remark

- The aluminum heat transfer plate can be removed; however, remember not to hold it with wet hands when the aluminum plate is cold, as there may be a risk of frostbite.
- When removing or installing the case, be sure to grasp the tray handle with your outstretched hand. Otherwise, the compartment door may accidentally hit your finger. Please refer to the illustration above.
- If cleaning by water, wipe the aluminum plate or allow it to dry before reinstalling into the refrigerator.
- Do not wipe the lubricant off the contact surface of the guide rail.
If you have wiped out the lubricant, please contact with the Panasonic service center.

Adjusting the position of the Wine rack on the Small glass tray of Fridge compartment and hanging the Wine rack under the Small glass tray of Fridge compartment:

■ Removing

- 1 Remove the Wine rack pins from the tabs on the Small glass tray of Fridge compartment.
- 2 Pull out the Wine rack.

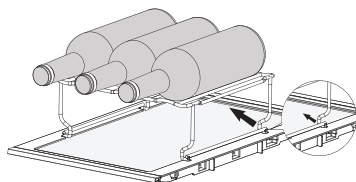

■ Attaching

- 1 Put the Wine rack at position to be mounted.
- 2 Adjust the pins of the Wine rack to the tabs on the Small glass tray of Fridge compartment.

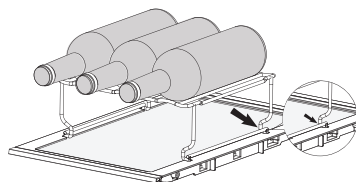

Adjusting the position of the Wine rack on the surface of the glass trays of Fridge compartment:

■ Removing

Lift the Wine rack out of the glass trays of the Fridge compartment.

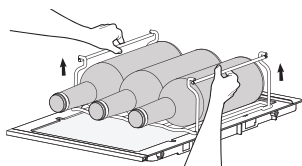

■ Attaching

Put the Wine rack on the glass trays of Fridge compartment, so that the Wine rack does not leave the protruding lugs on glass trays of Fridge compartment.

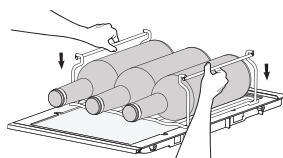

■ Removing

Lift and pull the Ice box forward until it is completely removed.

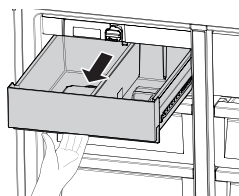

■ Attaching

Push the Ice box until it reaches the end of the Ice box holder.

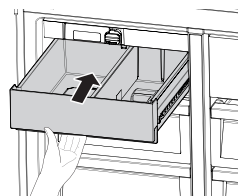

Note

- Stop the Auto Ice making function before cleaning the Ice box (Page 36).
- Remove the Customized divider and Ice scoop. Clean them with water, wipe or let them dry before attaching and returning to the Ice box.

How to clean the Refrigerator

Ice tray

Once every 3 months

The Ice tray can be cleaned by using the Auto Ice Clean function (Page 29). In addition, the Ice tray can be removed and cleaned manually.

How to clean the Ice tray manually.

■ Removing and cleaning the Ice tray

- 1 Choose the Auto Ice Off mode (Page 29).
- 2 Turn the knob on the Auto Ice maker to the unlocked position.
- 3 Pull the protruding side forward to remove the Ice tray.
- 4 Clean it with water. (Do not use sharp scouring pads to scrub the surface of Ice tray. If the Ice tray is scratched, ice may not be properly released, leading to a malfunction.)

Note

- The Ice tray and its frame cannot be separated.
- Do not clean with dishwashers or dish drying rack.

■ Attaching

- 1 Push the Ice tray in until you hear a “click”.
- 2 Turn the knob into the locked position.
- 3 Disable the Auto Ice Off mode (Page 29) to restart the Auto Ice making.

Note

- Ice will not be made automatically when the Auto Ice Off mode is turned on.
- Do not pour water directly into the Ice tray after manual cleaning. (That may cause ice cubes sticking together or a malfunction.)
- Turning the knob into the locked position after cleaning and checking the lock position of the Ice tray regularly is essential to ensure that the Auto Ice maker is working properly. If the knob is unlocked, the Auto Ice maker may not work.

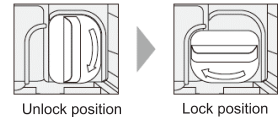
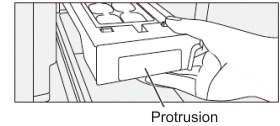
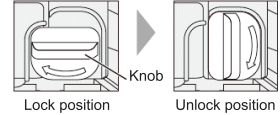

Features of the Panasonic SmartApp+

More convenience with your smartphone.

You can use the refrigerator through the “Panasonic SmartApp+”.

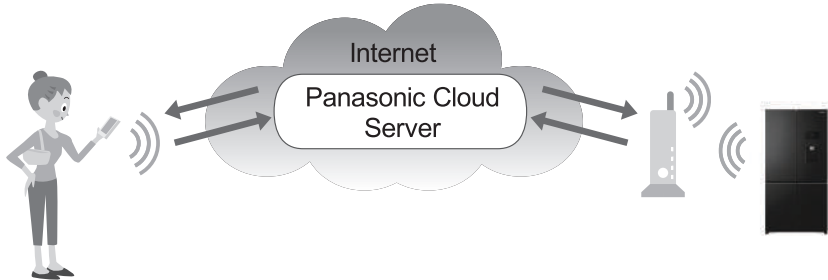

■ Remote control

Refrigerator modes can be controlled anytime, anywhere if connected to a wireless LAN network.

■ AI feature

AI ECONAVI will work better efficiency by detecting your location.

● Leaving home mode

If you are far away from the registered home location, AI ECONAVI will detect your location by GPS and switch the operation mode to energy saving mode.

● Shopping mode

If you shop at registered shopping locations, AI ECONAVI detects your location using GPS, after you confirm to active Shopping mode on the “Panasonic SmartApp+” application, refrigerator will start to increase the cooling level to prepare for food storage.

■ Monitoring through notifications

When the refrigerator encounters problems or other warnings appear, the notification will be displayed on your phone to help you promptly solve the problem and use the refrigerator more efficiently.

Panasonic SmartApp+

Required Equipment and Environment

Let's check the required Equipment and Environment to use the app.

- Android or iOS (iPhone) smartphone
 - About supported OS
<https://www.panasonic.com/fiot/fridge/>

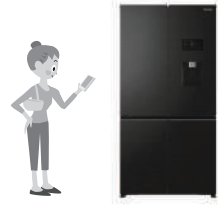

- Internet environment
 - Example) FTTH (optical fiber), ADSL, CATV (cable television), etc. Internet communication fee will be charged by you.
- Wireless LAN router
 - Use a wireless LAN router to connect to the internet.



Remark

- Make sure that the wireless LAN router has a communication standard of 2.4 GHz band. (Communication standards: IEEE802.11b, IEEE802.11g, IEEE802.11n)
Other than the above cannot be used.
- Models that only support WEP cannot be used.
- As a security measure, be sure to use a wireless LAN router that can set the encryption method WPA3, WPA2, or WPA.
- We recommend WPA3 and WPA2 (AES) as the encryption method.
- We do not guarantee the operation of all wireless LAN routers. (Mobile router is not guaranteed to work.)
- The refrigerator cannot connect to the router without password authentication.
- The refrigerator should not be connected to public wireless LAN network.
- The surrounding environment can affect the performance of the wireless network causing the remote control to not work properly.
- When connecting for the first time, you must make sure that the mobile phone and the refrigerator are connected to the same wireless network, otherwise the connection will not be successful.
- After the wireless LAN router changes its name or password, the refrigerator needs to be reconnected.
- Personal information related to customer activities such as Email, GPS signal,... is saved. To view details about the information stored, please open the "Panasonic SmartApp+" application, select "Menu", then select "Terms of Use".
- If the circuit board is replaced in the refrigerator, after repaired completely, the connection will need to be redone.

Required Equipment and Environment

- When you destroy or transfer the refrigerator, please delete the registered user information as below:
 - On the “Panasonic SmartApp+” application:
Open the “Panasonic SmartApp+” application, select “Menu”, then select “Withdraw from service” and select “OK”.
 - On the Operation Panel:
 - ① Press and hold “Remote” icon for 3 seconds, then the Operation Panel displays “C2”.
 - ② Press and hold “Freezer” icon and “Prime Freeze” icon for 3 seconds at the same time, refrigerator generates the notice sound and the Operation Panel displays “In”.
 - ③ The connection will be deleted when the Operation Panel no longer displays “In” and LED light of wireless LAN flashes.

Initial Settings

1 Install the “Panasonic SmartApp+” (free)

- You can find the link to download the application from “Panasonic Website”.
<https://www.panasonic.com/fiot/fridge/>
or the QR code as below:



- Alternatively, you can search for the “Panasonic SmartApp+” application on Google Play (Android) or App Store (iOS).
- You can check the Operating Instruction of “Panasonic SmartApp+” application directly from the application or find the link to download the Operating Instruction of “Panasonic SmartApp+” application from “Panasonic Website”.
 - **For Australia:**
<https://www.panasonic.com/au/consumer/household/refrigeration-learn/article/smart-connectivity/oi.html>
or the QR code as below:



- **For New Zealand:**
<https://www.panasonic.com/nz/consumer/home-appliances/kitchen-appliances-learn/article/smart-connectivity/oi.html>
or the QR code as below:



2 Follow instructions displayed on the screen of the app and register the refrigerator.

- Setup position of the refrigerator where you can check the display on the refrigerator door.



Use the app

Panasonic SmartApp+



Using the “Panasonic SmartApp+”

After initial setting is completed, you can use the application.

Please find the link below to check the update status of “Panasonic SmartApp+” application

<https://www.panasonic.com/ifiot/fridge/>

To check the communication status with the LED on Operation Panel:

	Light up	Communicatable (Connected)
	Blinking	Trying to communicate (Connecting to server)
	Off	Not connected

■ LED position (Page 21)

Usage for wireless LAN/Bluetooth®

■ Usage restrictions

Please note that there are the following restrictions while using. Panasonic is not liable for any incidental damages resulting from the failure to comply with the restrictions and the use or inability to use the machine.

- Do not connect to a wireless network that you do not have permission to use.
A wireless network (SSID^(*)) that you are not authorized to use may be displayed during detection, but if you connect it may be considered unauthorized access.
- Do not use in a place where magnetic field, static electricity, or radio interference is generated.
If you use the application near the following devices, communication may be interrupted or the speed may slow down.
 - Microwave oven
 - Other wireless LAN / Bluetooth® devices
 - Other devices that use radio waves in the 2.4 GHz band (digital cordless phones, wireless audio devices, game consoles, PC peripherals, etc.)
 - Metal objects that easily reflect radio waves

^(*) A name used to identify a specific network on a wireless LAN. If this SSID matches on both devices, communication is possible.

■ Security measures

- Since the wireless LAN uses radio waves to send and receive data, there is a risk of unauthorized access. Take security measures to ensure the safety of your data. Please note that we are not responsible for any problems that occur when not following the security measures.
- For the password (encryption key) of the wireless LAN router, refer to the instruction manual of the wireless LAN router and set it in consideration of security.

Troubleshooting

Before you call for service, please check the following steps:

The refrigerator does not operate.

- Check that the plug and its socket are in good condition.
- Check if there is any problem on the main fuse and electrical system of the house.
- Unplug the unit and wait for 7 minutes before plugging it back in.

The refrigerator does not cool enough.

- Check that the lights on the Operation Panel are displayed at the proper position.
- Check to see if the refrigerator is overloaded with stuff or if there is any hot foodstuff refrigerated inside.
- Is the refrigerator exposed directly to sunlight or heat source?
- Is the refrigerator door completely closed?
- Is the refrigerator door opened frequently?

Dew, frost appears.

Outside

- When the air humidity is high, there is a chance that moisture will condense on the refrigerator surface, around the door gasket or on the door surface. This situation will stop if the air humidity decreases. Please wipe it up with dry cloth.



Inside

- Is the door closed firmly?
- Is the door being opened and closed too frequently?
- Condensation inside the refrigerator can also be caused by leaving high-humidity foods uncovered or unwrapped.
- When the humidity is high, the door is open for a long time, or when the refrigerator contains too much food or makes too much ice, frost may form inside the Freezer compartment at the location of the Freezer compartment case, Ice box or the Prime Freeze case door. This is normal. Please wipe with dry and soft cloth.

The refrigerator generates noise.

- Check if the refrigerator is located on a stable floor or is installed properly.
- Check if there is any object in contact with the refrigerator.
- Cracking sound within caused by the parts adjusting temperature which is normal.
- After installation, the refrigerator may make loud noise. The noise will be less when the refrigerator has been cooled.

The inside is smelling.

- Do you store food with dry odor without wrapping it?

Light does not turn on.

- Please contact Panasonic service center.

Troubleshooting

The back and sides of the refrigerator are warm and hot.

- Because the refrigerator is equipped with the dew prevention and heat radiation tubes, the back and sides of the refrigerator get warmer when operating.
- The back and side plates may get warmer especially when starting up or if the door is frequently opened and closed.

The normal sounds of refrigerator.

- When the refrigerator starts operation, the sound like water flowing and boiling water is created. This is the sound of the cooling liquid.
- The noise is generated when the automatic defrost system operates.
- The dilatation of the details inside the refrigerator in the cooling process can cause sound "crack-crack".
- You may feel that the operation sound is larger because the compressor operates in high-speed under the following conditions: the refrigerator does not cool fully on the occasion such as using it for the first time, opening/closing the door too frequently, the surrounding temperature is high. The sound becomes more quiet after cooling fully.

The Operation Panel flashes.

- Are you adjusting the temperature of your refrigerator?
→ Flashes during adjusting. Please complete the setting and the Operation Panel will stop flashing after 5 seconds.

Food becomes frozen.

- Do you put the food near cold air holes?
- Do you adjust the temperature control to less than 4 °C for the Fridge compartment and/or -3 °C for the Prime Fresh case?
→ Adjust to a higher temperature.
- Do you put food in Prime Fresh case?

Error display on Operation Panel.

- The letter "H" and two digits are displayed on Operation Panel. For example: H01
→ Please contact the Panasonic service center for support.
- U10: Warning if doors are opened too long.
→ Check that the doors are closed properly.
- U83: The refrigerator does not connect to the wireless LAN router. Check the following:
 - The router is not turned on. → Power on.
 - The distance between the router and the refrigerator is too far.
→ Place the router close to the refrigerator.
 - A device that uses radio waves is used nearby, such as a microwave oven.
→ Keep an appropriate distance.
→ Stop using the device or wait for a while and try again.

Troubleshooting

Auto Ice making.

The refrigerator does not make ice.

- If the water in the tank does not decrease after a while, the ice maker is not working.
- The ice making process begins after the inside of the refrigerator is cold enough. (It may take more than 24 hours to start the process)
- Check if the Auto Ice Off mode is set. (Page 29)
- Be sure to fully push the Water tank and Ice tray into place.
- Do not leave food in the ice maker.
- Do not install or remove the Ice tray frequently.
- Check if the Water tank is almost empty.
- If water spills on the Ice box, clean it up.
- Please contact Panasonic service center.

The ice does not form any ice cube

- Is the temperature of Freezer compartment set to a higher temperature than -20 °C?
→ Adjust to a lower temperature. (Page 22)

Unusual shape of ice cubes.

- There are protrusions.
→ The grooves of the Ice tray may be frozen.
- The ice cubes are round or connected to other ice cubes.
→ Ice has been stored for a long time.
(Ice cubes get round of connected by sublimation.)
- The ice is small.
→ Small ice cubes are made when there is no water left in the tank.

Prime Fresh case 1 and Prime Fresh case 2

Food is over-frozen or not frozen.

- When the food in Prime Fresh case 1 or Prime Fresh case 2 is over-frozen.
→ Please set to a higher temperature than -3 °C.
- When the food in Prime Fresh case 1 or Prime Fresh case 2 is not partially frozen.
→ Set the temperature to as low as -5 °C.

Not cool, not freezing.

- Cooling or freezing may not be sufficient depending on the type of food, packaging condition, storage capacity, and how often the door is opened and closed.
→ Create space between foods for cold air circulation, arrange similar sized food in a Prime Fresh case and adjust the temperature accordingly.

Not fully sealed.

- When there is too much food, it may overflow from Prime Fresh case 1 or Prime Fresh case 2 and enter the gap behind Prime Fresh case 1 or Prime Fresh case 2, causing it not to be fully sealed.
→ Check the back of Prime Fresh case 1 or Prime Fresh case 2 contains food items? If so, remove them before attaching Prime Fresh case 1 or Prime Fresh case 2.
→ Arrange food properly to avoid overflowing.

Troubleshooting

The ECONAVI light does not come on normally.

The ECONAVI function does not work (the ECONAVI light does not come on).

- Are Quick Freezing, Quick Ice Making, Prime Freeze active?
- When the temperature is not set at 4 °C for the Fridge compartment and -20 °C for the Freezer compartment, the ECONAVI function does not activate automatically.
- Is the door opened too often or are there hot food stored in the refrigerator?
- The learning function can automatically disable the ECONAVI operation during regular use.
- Does the refrigerator display any error codes?

The ECONAVI operation is rarely active.

- Is there a power failure?
If there is a power failure, the data collected by the learning function until the power failure will be lost.
The ECONAVI operation is not active until the learning function can collect the data again.

The ECONAVI operation is stopped halfway.

- If the automatic defrost function is enabled while the ECONAVI operation is active, the normal cooling mode will be activated after the defrosting process completes. As a result, the ECONAVI operation may be stopped during defrosting/cooling.
- Sometimes, the learning function restarts the normal cooling mode.

The ECONAVI operation works too often (the ECONAVI light rarely turns off).

- Is the light intensity sensor hidden?
- Are there any dirt or scratches on Operation Panel of the light intensity sensor?
- The ECONAVI operation may operate while the refrigerator is in use depending on the usage conditions, but the cooling operation is still maintained.

Prime Freeze.

The food melts.

- Store frozen foods with the Prime Freeze case in a long period of time, or store high-fat ice cream in the freezer.
- Do not place cold food next to hot food.

Not cold, no freezing.

- Freezing capacity may not be sufficient depending on the type of food, packaging condition, storage capacity, and how often that the door is opened and closed.
→ Reset Prime Freeze. (Page 26)

Stop working halfway.

- If Prime Freeze is set during defrosting, the time display will start counting, but the fan will stop and the food will not be cooled enough. After defrosting, reset Prime Freeze.
- If Quick Ice Making, Quick Freezing, Prime Fresh+ are set during the operation of Prime Freeze, Prime Freeze will be stopped.

Troubleshooting

“Panasonic SmartApp+” application

Smartphone cannot be connected.

- Please refer Required Equipment and Environment section. (Page 48)

Forgot password

- From login screen, select “If you forgot your password, click here”, then set your password again.

Cannot connect to refrigerator

- Is the wireless LAN router turned off?
- The connection is not stable, please put the wireless LAN router near the refrigerator.

Cannot open the application

- Is your smartphone connected to Internet?

The LED of wireless LAN on the Operation Panel.

The LED of wireless LAN on the Operation Panel flashes.

- The LED of wireless LAN flashes every 0.5 seconds.
→ The wireless LAN connection may be disconnected. Please check the wireless LAN connection status again. (Page 30)
- The LED of wireless LAN flashes every 0.1 second.
→ The wireless LAN module communication may be faulty. Please contact Panasonic service center immediately.

The LED of wireless LAN on the Operation Panel turns on unexpectedly.

- Is the refrigerator being connected to wireless LAN?
Then, turn off the wireless LAN module, the LED of wireless LAN will turn off.

Water Dispenser

Droplets are kept on top of faucet

- After getting water, a few droplets are kept on top of nozzle and may drip into the Water tray. This is a normal phenomenon.
- When the air humidity is high, a few droplets are kept on top of nozzle and may flow into the Water tray. This is a normal phenomenon and no longer appears when the air humidity is decreased. Please clean with soft dry towel.
- When the air humidity is low but a few droplets are still kept on top of faucet and flows into the Water tray, please contact Panasonic service center immediately.

Only a few droplets flows into Water tray.

Water flows continuously

- Does the Water tray of the Water Dispenser have any abnormal object or scale formation?
→ Please clean the Water tray of the Water Dispenser if it has any abnormal object or scale formation.
- In case water flows continuously and no abnormal objects are in the Water tray, please contact Panasonic service center immediately.

Performance Data Sheet For Filter System Model: ARBHBA300020

This system has been tested according to NSF/ANSI 42, 53, 401 for reduction of the substances listed below. The concentration of the indicated substances in water entering the system was reduced to a concentration less than or equal to the permissible limit for water leaving the system, as specified in NSF/ANSI 42, 53, 401.



System tested and certified by NSF International against NSF/ANSI Standards 42, 53, 401 in System Model ARBHBA300020 for reduction claims specified on the Performance Data Sheet.

Substance	Influent Challenge Concentration	Average Reduction	Reduction Requirement	Max Permissible Product Water Concentration
Chlorine Taste and Odor	2 mg/ L ± 10%	97.5%	≥ 50%	N/A
Nominal Particulate Class I >0.5µm to 1µm	At least 10,000 particles/ ml	99.7%	≥ 85%	N/A
2,4-D	0.21 mg/ L ± 10%	98.7%	N/A	0.07 mg/ L
Atrazine	0.009 mg/ L ± 10%	> 94.8%	N/A	0.003 mg/ L
Cyst	Minimum 50,000/ L	> 99.99%	99.95 %	N/A
Mercury pH 6.5	0.006 mg/ L ± 10%	96.6%	N/A	0.002 mg/ L
Mercury pH 8.5	0.006 mg/ L ± 10%	95.9%	N/A	0.002 mg/ L
Asbestos	10 ⁷ to 10 ⁸ fibers/ L; fibers greater than 10µm in length	> 99%	99 %	N/A
Benzene	0.015 mg/ L ± 10%	> 97.0%	N/A	0.005 mg/ L
Lead pH 6.5	0.15 mg/ L ± 10%	99.3%	N/A	0.005 mg/ L
Lead pH 8.5	0.15 mg/ L ± 10%	> 99.3%	N/A	0.005 mg/ L
P-Dichlorobenzene	0.225 mg/ L ± 10%	> 99.8%	N/A	0.075 mg/ L
Toxaphene	0.015 mg/ L ± 10%	> 93.8%	N/A	0.003 mg/ L
Turbidity	11 ± 1 NTU	99.1%	N/A	0.5 NTU
Lindane	0.002 mg/ L ± 10%	> 99.1%	N/A	0.0002 mg/ L
Carbofuran	0.08 mg/ L ± 10%	98.7 %	N/A	0.04 mg/ L
Tetrachloroethylene	0.015 mg/ L ± 10%	> 96.6 %	N/A	0.005 mg/ L
O-Dichlorobenzene	1.8 mg/ L ± 10%	> 99.9 %	N/A	0.6 mg/ L
Ethylbenzene	2.1 mg/ L ± 10%	> 99.9 %	N/A	0.7 mg/ L
Chlorobenzene	2.0 mg/ L ± 10%	> 99.9 %	N/A	0.1 mg/ L
Endrin	0.006 mg/ L ± 10%	> 96.7 %	N/A	0.002 mg/ L
Meprobamate	400 ng/ L ± 20%	93.5 %	N/A	60 ng/ L
Atenolol	200 ng/ L ± 20%	94.7 %	N/A	30 ng/ L

Performance Data Sheet For Filter System Model: ARBHBA300020

Substance	Influent Challenge Concentration	Average Reduction	Reduction Requirement	Max Permissible Product Water Concentration
Carbamazepine	1,400 ng/ L ± 20%	98.4 %	N/A	200 ng/ L
DEET	1,400 ng/ L ± 20%	98.6 %	N/A	200 ng/ L
Metolachlor	1,400 ng/ L ± 20%	98.2 %	N/A	200 ng/ L
Trimethoprim	140 ng/ L ± 20%	96.4 %	N/A	20 ng/ L
Linuron	140 ng/ L ± 20%	> 96.5 %	N/A	20 ng/ L
TCEP	5,000 ng/ L ± 20%	> 98.1 %	N/A	700 ng/ L
TCPP	5,000 ng/ L ± 20%	98.2 %	N/A	700 ng/ L
Phenytoin	200 ng/ L ± 20%	> 94.4 %	N/A	30 ng/ L
Ibuprofen	400 ng/ L ± 20%	> 95.4 %	N/A	60 ng/ L
Naproxen	140 ng/ L ± 20%	> 97.5 %	N/A	20 ng/ L
Estrone	140 ng/ L ± 20%	> 95.2 %	N/A	20 ng/ L
Bisphenol A	2,000 ng/ L ± 20%	99.0 %	N/A	300 ng/ L
Nonyl phenol	1,400 ng/ L ± 20%	> 96.4%	N/A	200 ng/ L
Microplastics, particles 0.5 to < 1µm	At least 10,000 particles/ ml	99.7%	≥ 85%	N/A

Operation Conditions

Capacity	1,136 L (300 gal)
Function	Chemical / Mechanical
Usage Life	6 months
Flow Rate	1.9 lpm (0.5 gpm)
Temperature	1 ~ 38 °C (34 ~ 100 °F)
Pressure	206 ~ 861 kPa (30 ~ 125 psi)

System model: ARBHBA300020
 Replacement Cartridge: ARAHFA105010
 EPA Number: EPA Est No.94813-KOR-1
 (NSF/ANSI Standard 53 Certified to reduce Cyst by mechanical means.)
 Manufactured by Microfilter Co.,Ltd.
 162-1, Sansu, Deoksan, Jincheon, Chung-Buk 27856, Korea.
 Made in Korea
 Tel no.: T: 82-43-531-7021~5 /F: 82-43-530-5499

Remark

- Systems must be installed and operated in accordance with manufacturer's recommended procedures and guidelines. Follow any and all local plumbing codes and requirements. Some local codes may require the use of a licensed plumber or a certified installer when disrupting a potable water line.
- Failure to follow instructions may result in voidance of warranty.
- Change the filter cartridge at least every 6 months.
- To reduce the risks associated with water leakage, which, if not avoided, may result in property damage - check with your plumbing professional to verify that water pressure is less than 827 kPa (120 psi).

Specifications

Model No.		NR-XY680L
Freezer Star Rating		
Capacity (L) (IEC 62552:2015)	Total	618
	Freezer	212
	Fridge, Prime Fresh	406
Outside Dimensions Width x Depth x Height (mm)		900 x 750 x 1790
Net Weight (kg)		107
Refrigerant Type		R600a
Cooling System		Non-frost cooling.
Rated Voltage (V) Rated Frequency (Hz)		Refer to the rating label attached inside the cabinet.

Disposal



For the purpose of recycling to facilitate utilization of resources, please return this product to a nearby authorized collection center, registered dismantler or recycler, or Panasonic service center when disposing of this product.

Customer care number: 132600 (AU)
09 272 0178 (NZ)

Please see the Panasonic website for further information on collection centers, etc. or call the customer care number.

<https://www.panasonic.com/au>

<https://www.panasonic.com/nz>

Copyright

- Android and Google Play are trademarks or registered trademarks of Google LLC.
- iPhone is a trademark of Apple Inc., registered in the U.S. and other countries.
- The App Store is a service mark of Apple Inc.
- “WPA™”, “WPA2™” and “WPA3™” are trademarks of “Wi-Fi Alliance®”.
- QR Code is registered trademark of DENSO WAVE INCORPORATED.
- Bluetooth® word mark and logo are registered trademarks owned by Bluetooth SIG, Inc.
- Panasonic Corporation uses these marks under license. Other trademarks and trade names are property of their respective owners.
- Other names, company names, product names, etc. described in this manual are trademarks or registered trademarks of their respective companies. Some™ and® marks are not included in the text.

■ About software

This product consists of the following types of software.

- (1) Software developed by or for Panasonic Corporation (Panasonic)
- (2) Software owned by a third party and licensed to Panasonic
- (3) Conditionally licensed open source software

The software classified in (3) above is distributed with the expectation that it will be useful on its own, but we do not warrant any implied guarantee of “commerciality” or “fitness for a specific purpose”. No warranty is given, including,

You can find the link to download the most up-to-date information of Copyright for “Panasonic SmartApp+” application.

• For Australia:

<https://www.panasonic.com/au/consumer/household/refrigeration-learn/article/smart-connectivity/oi.html>
or QR code as below:



• For New Zealand:

<https://www.panasonic.com/nz/consumer/home-appliances/kitchen-appliances-learn/article/smart-connectivity/oi.html>
or QR code as below:



