

Panasonic®

OPERATING INSTRUCTIONS Automatic Bread Maker (Household Use)

Model No. **SD-YR2550**
SD-R2530



SD-YR2550



Thank you for purchasing the Panasonic product.

- Please read instructions carefully to use the product correctly and safely.
- Before using this product, **please give your special attention to Safety Precautions (See P. 3–5) and Important Information (See P. 6) of this instructions.**
- Please keep instructions for future use.
- Panasonic will not accept any liability if the product is subject to improper use, or failure to comply with these instructions.

Contents

Safety Precautions	3	Baking Gluten Free Cake	16
Important Information	6	● Making Gluten Free Pizza / Gluten Free Pasta	17
Parts Names and Instructions	7	● Baking Cake	17
● Main Unit	7	● Bake Only	18
● Accessories	7	● Making Jam / Compote	18
● Control Panel and Display	8	● Cake Kneading	19
Bread -making Ingredients	9	● Bread Kneading	19
Menu Charts and Baking Options	10	● Rise.....	19
Handling Instructions	12	Recipes	20
● Before Use	12	● Bread Recipes.....	20
● Preparations	12	● Gluten Free Recipes	25
● Baking Bread	13	● Dough Recipes	26
● Making Dough	13	● Sweet Recipes.....	29
● Additional Ingredients	14	● Manual Recipes	30
● Bread Mix & Bread Mix Raisin	14	Cleaning & Care	31
● Baking Brioche	15	Troubleshooting	32
● Sourdough & Sourdough Dough	15	Warrenty	36
● Gluten Free Information.....	16	Specifications	38
● Baking Gluten Free Bread.....	16		

Safety Precautions

Please make sure to follow these instructions.

To reduce the risk of personal injury, electric shock or fire, please observe the following:

- The following signals indicate the degree of harm and damage when the appliance is misused.

 **WARNING:** Indicates potential hazard that could result in serious injury or death.

 **CAUTION:** Indicates potential hazard that could result in minor injury or property damage.

- The symbols are classified and explained as follows.

 This symbol indicates prohibition.

 This symbol indicates requirement that must be followed.

WARNING

To avoid risk of electric shock, fire due to short circuit, smoke, burn or injury.

-  ● **Do not allow infants and children to play with packaging material.**
(It may cause suffocation.)
- **Do not disassemble, repair or modify this appliance.**
→ Consult the place of purchase or Panasonic service centre.
- **Do not damage the power cord or power plug.**
Following actions are strictly prohibited:
Modifying, touching on or placing near heating element or hot surfaces, bending, twisting, pulling, hanged/pulled over sharp edges, putting heavy objects on top, bundling the power cord or carrying the appliance by the power cord.
- **Do not use the appliance if the power cord or power plug is damaged or the power plug is loosely connected to the household power outlet.**
→ If the power cord is damaged, it must be replaced by the manufacturer, its service centre or similarly qualified person in order to avoid a hazard.
- **Do not plug or unplug the power plug with wet hands.**
- **Do not immerse the appliance in water, or splash it with water and/or any liquid.**
- **Do not touch, block or cover the steam vent during use.**
 - Especially pay attention to children.

WARNING

To avoid risk of electric shock, fire due to short circuit, smoke, burn or injury.

-  ● **This appliance is not intended for use by persons (including children) with reduced physical, sensory or mental capabilities, or lack of experience and knowledge, unless they have been given supervision or instruction concerning use of the appliance by a person responsible for their safety.**
Children should be supervised to ensure that they do not play with the appliance.
- **Keep the appliance and its power cord out of reach of children.**
- **Make sure the voltage indicated on the label of the appliance corresponds to your local supply.**
Also avoid plugging other devices into the same household powder outlet to prevent electrical overheating. However, if you are connecting a number of power plugs, make sure the total wattage does not exceed the rated wattage of the household powder outlet.
- **Insert the power plug firmly.**
- **Dust off the power plug regularly.**
→ Unplug the power plug, and wipe with a dry cloth.
- **Discontinue using the appliance immediately and unplug in the unlikely event that this appliance stops working properly.**
Example for abnormal occurrences or breaking down:
 - The power plug and the power cord become abnormally hot.
 - The power cord is damaged or the appliance power fails.
 - The main body is deformed, has visible damage or is abnormally hot.
 - There is abnormal turning noise while in use.
 - There is unpleasant smell.
 - There is another abnormality or failure.→ Consult the place of purchase or Panasonic service centre for inspection or repair.
- **Do not use the appliance if the parts of the appliance is deformed or damaged such as having visible cracks or chips.**
→ Consult the place of purchase or Panasonic service centre for inspection or repair.

CAUTION

To avoid risk of electric shock, fire, burn, injury or property damage.



● Do not use the appliance on following places.

- On uneven surfaces, on electrical appliances such as a refrigerator, on materials such as tablecloths or on carpets, etc.
 - Places where it may be splashed with water or near a heat source.
- Position the appliance on a firm, dry, clean, flat heatproof worktop at least 10 cm from edge of worktop and at least 5 cm from adjacent walls and other objects.

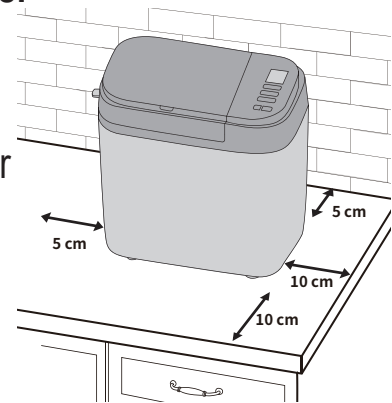

● Do not remove the bread pan or unplug the appliance during use.

● Do not touch hot area such as bread pan, inside of unit, heating element or inside of the lid while the appliance is in use or immediately after use.

The accessible surfaces may become hot during use. Be careful with the residual heat source especially after use.

→ To avoid burn, always use oven gloves to remove the bread pan or the finished bread. (Do not use wet oven gloves.)

● Do not use an external timer etc.

- This appliance is not intended to be operated by means of an external timer or separate remote-control system.

● Do not insert any object in the gaps.

● Do not exceed the maximum quantities of flour (620 g) and raising ingredients such as dry yeast (8.4 g), SUREBAKE yeast (9.8 g) or baking powder (13 g). (See P. 38)



● Unplug the power plug when the appliance is not in use.

● Make sure to hold the power plug when unplugging it. Never pull on the power cord.

● Before handling, moving or cleaning, unplug the appliance and allow it to cool down.

● This appliance is intended for household use only.

● Ensure to clean the appliance especially surfaces in contact with food after use. (See P. 31)

Important Information

- Do not use the appliance outdoors, in rooms of high humidity, or use excessive force on the parts as is illustrated on the right to avoid malfunction or deformation.
- Do not use a knife or any other sharp tool to remove residues.
- Do not drop the appliance to avoid damaging it.
- Do not store any ingredients or bread in the bread pan.

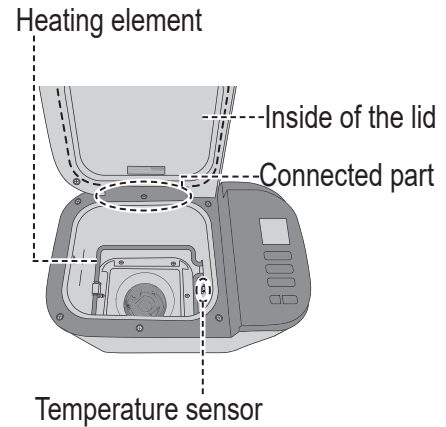

This symbol on the appliance indicates “Hot surface and should not be touched without caution”.

Parts Names and Instructions

Main Unit

- Illustration of product in this instructions are exemplified by SD-YR2550.

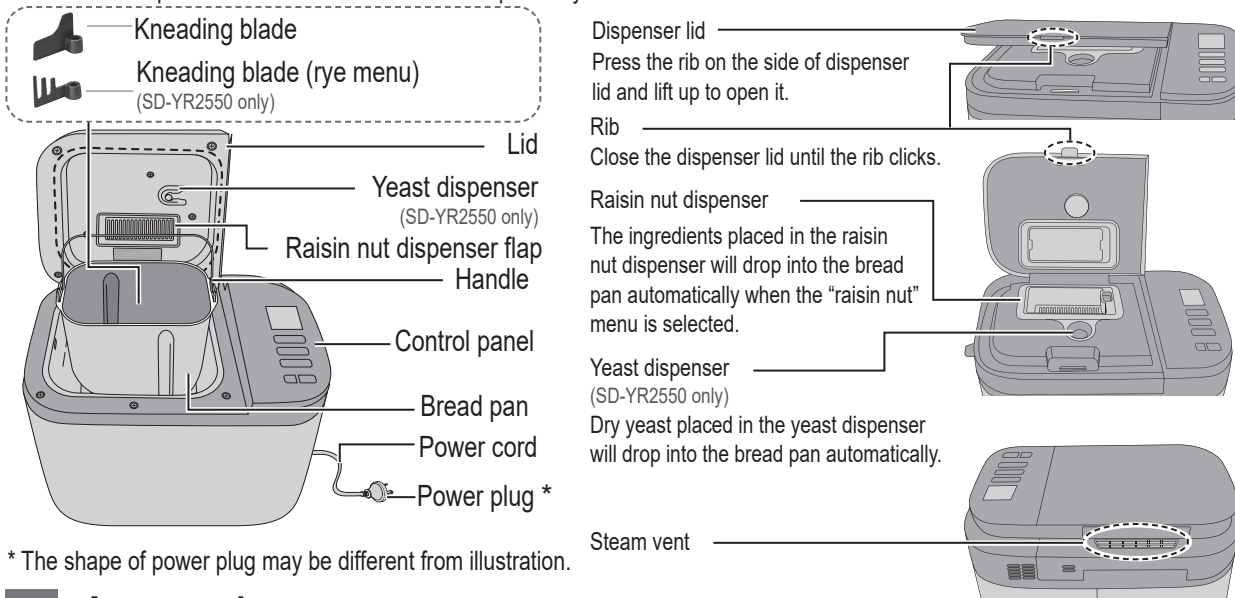

Accessories

Sourdough cup

To measure out liquids or make sourdough starter.

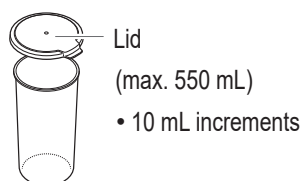

Measuring spoon

To measure out sugar, salt, dry yeast, etc.

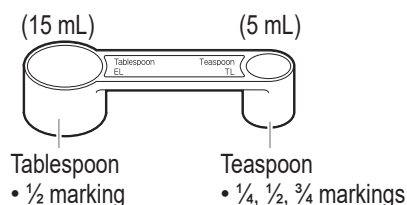

Sourdough starter spoon

To measure out sourdough starter yeast.

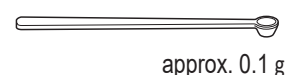

Bread pan and kneading blade are coated with a non-stick finish to avoid stains and to make it easier when removing bread.

■ To avoid damaging it, please follow the instructions below.

- Do not use hard utensils such as a knife or a fork when removing the bread from the bread pan.
 If the bread cannot be easily removed from the bread pan, leave the bread pan for 5 – 10 minutes to cool, making sure that it is not left unattended where somebody or something may get burnt. After that, shake the bread pan several times using oven gloves. (See P. 13)
 (Hold the handle down so that it does not get in the way of bread.)
- Ensure that the kneading blade is not embedded in the bread loaf before slicing it.
 If it is embedded, wait for the loaf to cool and remove it.
 (Do not use hard or sharp utensils such as a knife or a fork.)
 Be careful not to get burn as the kneading blade may still be hot.
- Use the soft sponge when cleaning the bread pan and the kneading blade.
 Do not use anything abrasive such as cleansers or scouring pads.
- Hard, coarse or large ingredients such as flours with whole or ground grains, sugar, or the addition of nuts and seeds may damage non-stick finish coating. If using large chunks of ingredient, break or cut into small pieces. Please follow the information of **Additional Ingredients** (see P. 14) and the recipe quantities stated.
- Use only supplied kneading blade for this appliance.

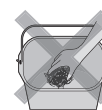

The bread pan, kneading blade and bread may be very hot after baking. Always handle with care.

Parts Names and Instructions

Control Panel and Display

- Picture shows all words and symbols, but only those relevant will be displayed during operation.

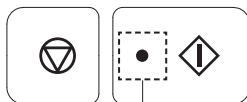
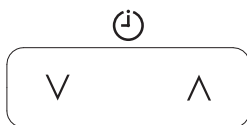
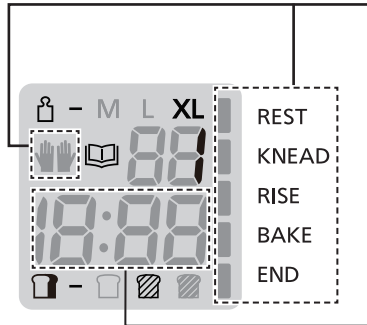

Operation status

Displayed for the current stage of the program except .
 : Provide an indication of doing manual operation.
 (See P. 10-11 for available menu.)

Time showing

- Time remaining until ready.
- Menu required some manual steps, display will show the remaining time until starting its process after press button.

Menu

- Press or once to be a setting mode.
- Press or again to change Menu number.
 (To advance more quickly, hold the button.) (See P. 10-11 for menu number.)

Size

Press this button to choose size. (See P. 10-11 for available menu.)



Crust

Press this button to choose crust colour. (See P. 10-11 for available menu.)



Timer

- Set delay timer (time until bread is ready).
 For available menu, it can be set up to 13 hours (except menu sourdough only set up to 9 hours). (See P. 10-11)
 e.g.: It is 9:00 PM now, and you want the bread to be ready at 6:30 the next morning.
 → Set the timer to **9:30** (9 hours and 30 minutes from now).

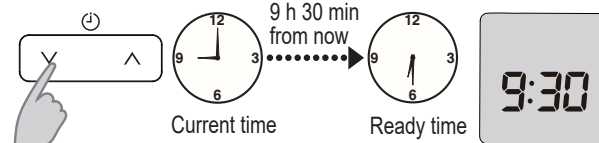

Stop

To cancel the setting/stop the program.
 (Hold for approximately 1 second.)

Start

Press this button to start the program.

Status indicator

- Flash indicates that the machine is in set state or manual operation is required.
 button can be pressed.
- Always light indicates that the machine is in program execution state.
 button cannot be pressed.
 It will not turn on even plugged in.

Setting time for Sweet Menus:

- "" press this button to increase the time.
- "" press this button to decrease the time.
 (To advance more quickly, press this button once then hold it.)
- Menu "Cake"
 Pressing the button once will advance the additional baking time by 1 minute.
- Menu "Bake Only"
 Pressing the button once will advance the baking time including additional baking time by 1 minute.
- Menu "Jam" and "Compote"
 Pressing the button once will advance the cooking time by 10 minutes but additional cooking time will be by 1 minute.

Bread-making Ingredients

It is extremely important to use the correct measure of ingredients for best results.

Liquid ingredients

Use the sourdough cup or measuring spoon provided.

If the recipes indicate a mixture (the liquid plus egg), should be weighted on scales. Using digital scale is recommended.

Dry ingredients

Should be weighed on scales or measured with measuring spoon provided for the small amounts. Using digital scale is recommended.

Flour

Main ingredient of bread. The protein in flour forms gluten during kneading. Gluten provides structure and texture and helps the bread to rise.

Use strong bread flour. Strong bread flour is milled from the wheat and has a high content of protein which is necessary for the development of gluten. Carbon dioxide produced during fermentation is trapped within the elastic network of gluten, thus making the dough rise.

White flour

Made by grinding wheat kernel, excluding bran and germ. The best kind of flour for baking bread is a flour marked "for bread baking".

Do not use plain or self-raising flour as a substitute for bread flour.

Wholemeal flour

Made by grinding entire wheat kernel, including bran and germ.

Makes very health-giving bread. This bread is lower in height and heavier than bread baked with white flour.

Rye flour

Made by grinding rye kernel. Contains more iron, magnesium and potassium, which contribute to good health.

Due to the low gluten content, it makes a dense, heavier bread.

Do not use more than stated quantity (could overload motor).

Dry yeast

Enables the bread to rise.

Be sure to use dry yeast that does not require pre-fermentation. Do not use yeast that requires preliminary fermentation. Dry yeast which has "Easy blend", "Fast Action" or "Easy Bake" written on the packet is recommended.

When using dry yeast from sachets, seal the sachet again immediately after use. To store, follow the Manufacturer's instructions and discard after 48 hours of opening. It is recommended on most yeast packets to keep in a cool dry place.

Dairy products

Add flavour and nutritional value.

- If you use milk instead of water, the nutritional value of the bread will be higher, but do not use in timer setting as it may not keep fresh overnight.
- Reduce the amount of water proportionally to the amount of milk.

Sugar (granulated sugar, brown sugar, honey, treacle, etc.)

Food for the dry yeast, sweetens and adds flavour to the bread, changes the colour of the crust.

- Use less sugar if using raisins or other fruits, which contain fructose.

Water

Use normal tap water.

When room temperature is low, use tepid water for menu "Basic Rapid", "Bread Mix", "Bread Mix Raisin", "Whole Wheat Rapid", "Rye", "Gluten Free Bread" or "Gluten Free Pasta".

When room temperature is high, use chilled water for menu "Rye", "French" or "Brioche".

Always measure out liquids using the sourdough cup provided.

Salt

Improves the flavour and strengthens gluten to help the bread rise. The bread may lose size/flavour if measuring is inaccurate.

Fat

Adds flavour and softness to the bread.

Use butter (unsalted), margarine or oil.

You can make your bread taste better by adding other ingredients.

■ Eggs

Improve the nutritional value and colouring of the bread. (Water amount must be reduced proportionally.) Beat eggs when adding eggs. Do not use the timer for the recipe with egg. (Eggs go rotten quickly if your room temperature is high.)

■ Bran

Increases the bread's fibre content.

- Use max. 50 g (5 tbsp).

■ Wheat germ

Gives the bread a nuttier flavour.

- Use max. 50 g (4 tbsp).

■ Spices, herbs

Enhance the flavour of the bread.

- Only use a small amount (max. 1 tbsp).

If using a bread mix...

■ Bread mixes including dry yeast

① Place the mix in the bread pan, then add water.

(Follow instructions on the packet for the quantity of water)

② Select menu 5 or 6.

- With some mixes, it is not clear how much dry yeast is included, so some trial and error may be required to obtain optimum results.

■ Bread mix with separate dry yeast sachet

① First place the bread mix in the bread pan, then the water. Then place the measured dry yeast in the yeast dispenser.

(For SD-R2530, place the dry yeast in the bread pan first, then the bread mix, then the water.)

② Set the machine according to the type of flour included in the mix, and start the baking.

- White flour - recommended for menu 5, 6.
- Brown flour - menu 1
- Whole wheat - menu 7
- Rye flour - menu 12 (SD-YR2550 only)

■ Baking brioche with brioche mix

Select the menu 10 or 2 - "Medium" size - "Light" crust colour.

Tips: The outcome differs depending on the type of mixed flour.

Menu Charts and Baking Options

Function Availability and Time Required

- The machine stops or moves during process based on the operating program.
- Time required for each process will differ according to room temperature.

Menu Number	Menu	Options	Processes							Remark	Refer. Page		
			Size	Crust	Timer	Rest	Knead	Rise	Bake			Total	
SD-YR2550	SD-R2530												
Bread	1	1	Basic	✓	✓	✓	30 – 60 min	20 – 30 min *4	1 h 50 min – 2 h 20 min	50 – 55 min	4 h – 4 h 5 min	—	P. 12-13
	2	2	Basic Rapid	✓	✓	—	—	15 – 20 min	approx. 1 h	35 – 40 min	1 h 55 min – 2 h	—	P. 12-13
	3	3	Basic Raisin	✓	✓*1	✓	30 – 60 min	20 – 30 min *4	1 h 50 min – 2 h 20 min	50 min	4 h	—	P. 12-14
	4	4	Basic Stuffed	✓	✓	✓	30 – 60 min	25 – 30 min *4	1 h 45 min – 2 h 10 min	50 – 55 min	4 h – 4 h 5 min	✓	P. 12-14
	5	5	Bread Mix	—	✓	—	—	30 min *4	1 h 15 min	45 min	2 h 30 min	—	P. 12-14
	6	6	Bread Mix Raisin	—	✓	—	—	30 min *4	1 h 15 min	45 min	2 h 30 min	—	P. 12-14
	7	7	Whole wheat	✓	—	✓	1 h – 1 h 40 min	15 – 25 min *4	2 h 10 min – 2 h 50 min	50 min	5 h	—	P. 12-13
	8	8	Whole wheat Rapid	✓	—	—	15 – 25 min	15 – 25 min *4	1 h 30 min – 1 h 40 min	45 min	3 h	—	P. 12-13
	9	9	Whole wheat Raisin	✓	—	✓	1 h – 1 h 40 min	15 – 25 min *4	2 h 10 min – 2 h 50 min	50 min	5 h	—	P. 12-14
	10	10	Brioche	—	✓*1	—	20 min	30 – 60 min *4	1 h 20 min – 1 h 30 min	45 min	3 h 30 min	✓	P. 12, 15
	11	—	French	—	—	✓	—	40 min – 1 h 20 min *4	3 h 30 min – 4 h 10 min	50 min	5 h 40 min	—	P. 12-13
	—	11	French	—	—	✓	5 min – 1 h	35 – 40 min *4	3 h 10 min – 4 h 10 min	50 min	5 h 40 min	—	P. 12-13
	12	—	Rye	—	—	✓	45 – 60 min	approx. 10 min	1 h 20 min – 1 h 35 min	1 h	3 h 30 min	—	P. 12-13
13	12	Sourdough	—	—	✓*3	0 – 55 min	45 – 55 min *5	2 h 25 min – 3 h 10 min	55 min	5 h	—	P. 15	
Gluten Free	14	13	Gluten Free Bread	—	✓*2	—	—	20 – 25 min *7	35 – 40 min	50 – 55 min	1 h 50 min – 1 h 55 min	✓	P. 12, 16
	15	14	Gluten Free Cake	—	—	—	—	20 min *6	—	1 h 30 min	1 h 50 min	✓	P. 12, 16
	16	15	Gluten Free Pizza	—	—	—	—	20 – 25 min *7	5 – 10 min	—	30 min	✓	P. 12, 17
	17	16	Gluten Free Pasta	—	—	—	—	15 min *7	—	—	15 min	✓	P. 12, 17

- Abbreviations used in this instructions, a full name written as follows: min = minute (s); h = hour (s); approx. = approximately.
- Remark (): The menu is available to do manual operation such as adding extra ingredients and scraping the flour from sidewall of bread pan, when the beep sounds.

	Menu Number		Menu	Options			Processes					Remark	Refer. Page
	SD-YR2550	SD-R2530		Size	Crust	Timer	Rest	Knead	Rise	Bake	Total		
Dough	18	17	Basic	—	—	—	30 – 50 min	15 – 30 min *4	1 h 10 min – 1 h 30 min	—	2 h 20 min	—	P. 12-13
	19	18	Basic Raisin	—	—	—	30 – 50 min	15 – 30 min *4	1 h 10 min – 1 h 30 min	—	2 h 20 min	—	P. 12-14
	20	19	Whole wheat	—	—	—	55 min – 1 h 25 min	15 – 25 min *4	1 h 30 min – 2 h	—	3 h 15 min	—	P. 12-13
	21	20	Whole wheat Raisin	—	—	—	55 min – 1 h 25 min	15 – 25 min *4	1 h 30 min – 2 h	—	3 h 15 min	—	P. 12-14
	22	21	Sourdough Dough	—	—	—	0 – 40 min	45 – 55 min *5	1 h 5 min – 1 h 35 min	—	2 h 30 min	—	P. 15
	23	22	Sourdough Starter	—	—	—	—	—	24 h	—	24 h	—	P. 15
	24	23	Pizza	—	—	✓	(Knead) 10 – 18 min	(Rise) 7 – 15 min	(Knead) approx. 10 min	(Rise) approx. 10 min	45 min	—	P. 12-13
Sweet	25	24	Cake	—	—	—	—	20 min *6	—	1 h 35 min	1 h 55 min	✓	P. 12, 17
	26	25	Bake Only	—	—	—	—	—	—	30 min– 1 h 30 min	30 min– 1 h 30 min	—	P. 18
	27	26	Jam	—	—	—	—	—	—	—	1 h 30 min– 2 h 30 min	—	P. 18
	28	27	Compote	—	—	—	—	—	—	—	1 h – 1 h 40 min	—	P. 18
Manual	29	28	Cake Kneading	—	—	—	—	20 min (default)	—	—	1 – 20 min	—	P. 19
	30	29	Bread Kneading	—	—	—	—	20 min (default)	—	—	1 – 20 min	—	P. 19
	31	30	Rise	—	—	—	—	—	30 min (default)	—	10 min – 2 h	—	P. 19

*1 Only “Light” or “Medium” are available.

*2 Only “Medium” or “Dark” are available.

*3 Can be set up to 9 hours.

*4 There is a period of rise during the knead period.

*5 There is a period of rest during the knead period.

*6 There is a period of scraping or molding during the knead period.

*7 There is a period of scrape off the flour.

Handling Instructions

Before Use

- For the first time use, remove packing material and clean the machine. (See P. 31)
- Clean the machine when you have not used for a long time. (See P. 31)

Preparations

- 1** Open the lid, remove the bread pan (1) and set the kneading blade into the kneading mounting shaft. (2)

- Check around the shaft and inside the kneading blade and ensure that they are clean. (See P. 31)

- 2** Prepare the ingredients with **exact measurement** according to the recipe.

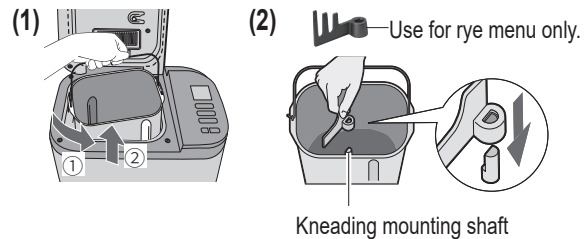

For SD-YR2550

Note: For the recipes using SUREBAKE yeast, Place SUREBAKE yeast into bread pan first.

- 3** **1** Place the measured ingredients into the bread pan in the order listed in the recipes.
 - Pour liquid in the edge of bread pan's sidewall to avoid splashing. (3)
- 2** Wipe off any moisture and flour around the bread pan, and return it into the main unit. (4) **Close the lid.**
 - Place the dry yeast into the yeast dispenser for available menus. (5)
If the yeast dispenser is wet, absorb wetness with tissue etc. (Do not rub the yeast dispenser, otherwise the dry yeast will not drop into the bread pan due to static.)
 - Add additional ingredients into the raisin nut dispenser for available menus. (See P. 14)
 - For optimum results, do not open the lid unless the menu requires, as it affects bread quality.

For SD-R2530

- 3** **1** Place the measured ingredients into the bread pan in the order listed in the recipes.
 - For bread and dough menus, dry yeast should be placed first.
 - ① Place dry yeast away from the kneading blade and kneading mounting shaft. If some of the dry yeast get into it, bread may not rise well.
 - ② Place dry ingredients over the dry yeast.
It must be kept separate from any liquid until mixing commences.
 - Pour liquid in the edge of bread pan's sidewall to avoid splashing. (3)
- 2** Wipe off any moisture and flour around the bread pan, and return it into the main unit. (4) **Close the lid.**
 - Add additional ingredients into the raisin nut dispenser for available menus. (See P. 14)
 - For optimum results, do not open the lid unless the menu requires, as it affects bread quality.

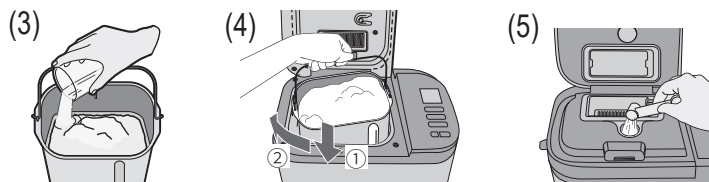

- 4** Plug the machine into 230 - 240 V socket.

Make sure to complete the preparation steps before setting menu.

Baking Bread



5 Press \wedge or \vee button in the Menu (📖) bar to select a bread menu.

- Choose the options for the selected menu. (See P. 8, 10-11)

- Bread Size
- Crust colour
- Delay timer

6 Press Start (⏏) button to start the machine.

(The display shows when menu "1" is selected.)

- Display shows the remaining time until the selected program is complete.
- * The remaining time is changed depending on the room temperature.

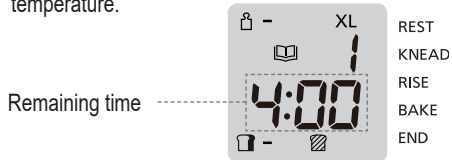

- Do manual operation when the beep sounds if you select the certain menus. (See P. 10 - 11, menus with 🧤 icon.)

After that, then press ⏏ button again.

- Complete the works while 🧤 is flashing on the display.
- When 🧤 stop flashing, display shows the remaining time.
- Do not add ingredients after display shows remaining time.
- Kneading will continue after a certain time without press ⏏ button.

7 When bread is ready (machine beeps 8 times and the cube (■) near END flashes), press Stop (⏏) button and unplug.

8 Remove the bread immediately by using dry oven gloves and place it on a wire rack. (6)

- Hold the handle with oven gloves and shake the bread out.

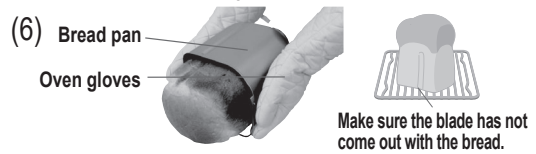

- Moving the outside base shaft may damage the bread shape. (7)

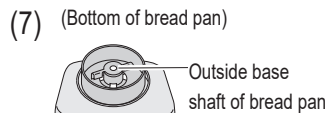

- Always remove the kneading blade before slicing bread. (8)

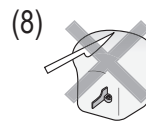

Making Dough



5 Press \wedge or \vee button in the Menu (📖) bar to select a dough menu.

6 Press ⏏ button to start.

- Display shows the remaining time until the program is complete.

7 When dough is ready (machine beeps 8 times and the cube (■) near END flashes), press ⏏ button and unplug.

Tips: Timer is not available on doughs menus except Pizza.

Bread Dough

8 Shape the finished dough to your favourite shape and allow it to rise until double size, then bake in the oven.

Pizza Dough

8 Divide the dough with scraper and shape them into balls.

9 Cover them with damp kitchen towel and leave it for 10 minutes.

10 Shape into a flat round and make holes with a fork.

11 Spread your favourite sauce and desired topping then bake it in the oven.

Handling Instructions

Additional Ingredients (Dried fruits, nuts, bacon, cheese etc.)

Available Menu

	Bread				Dough	
	Basic Raisin	Basic Stuffed	Bread Mix Raisin	Whole Wheat Raisin	Basic Raisin	Whole Wheat Raisin
SD-YR2550	Menu 3	Menu 4	Menu 6	Menu 9	Menu 19	Menu 21
SD-R2530					Menu 18	Menu 20

To make your flavoured bread, simply place additional ingredients in the raisin nut dispenser or bread pan.

Attention of ingredients

Follow the recipe/menu instructions for the quantities of each ingredients.

Otherwise, • The ingredients may scatter from bread pan to cause unpleasant smells and smoke.

- The bread may not rise well.

Dry/insoluble ingredients (Using raisin nut dispenser - add automatically)

→Place the extra ingredients in the raisin nut dispenser and set the machine.

→Do not overfill the raisin nut dispenser.

■ Dried fruits

- Cut up roughly into approximate 5 mm cubes.
- Sugar-coated ingredients may stick to the raisin nut dispenser and not fall into the bread pan.

■ Nuts, seeds

- Chop finely.
- Nuts impair the effect of gluten, so avoid using too much.
- Using large, hard seeds may scratch the coating of the dispenser and bread pan.

■ Herbs

- Use up to 1 – 2 tbsp of dried herbs. For fresh herbs, follow the instructions in the recipe.

■ Bacon, salami, olives, dry tomato

- Sometimes oily ingredients may stick to the raisin nut dispenser and not fall into the bread pan.
- Cut the bacon and the salami into 1 cm cubes.
- Cut the olives into quarters.

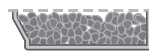

Correct



Incorrect

Moist / viscous / soluble ingredients*

(Adding into the bread pan by hands - cannot be placed in the raisin nut dispenser)

→Place these ingredients together with the others into the bread pan.

■ Fresh fruits, fruits pickled in alcohol, vegetables

- Only use quantities as in the recipe, as the water content in the ingredients will affect bread.

■ Cheese, chocolate

- Cut the cheese into 1 cm cubes.
- Chop chocolate finely.

* These ingredients cannot be placed in the raisin nut dispenser as they would stick to it and not fall into the bread pan.

Bread Mix & Bread Mix Raisin



Turn to P. 22 for recipes.

1 – 4 See P. 12 of Preparations

5 Select the menu.

	Bread Mix	Bread Mix Raisin
SD-YR2550	Menu 5	Menu 6
SD-R2530		

6 Press button to start.

- Display shows the remaining time until the program is complete.

7 Press button and remove bread when machine beeps 8 times and the cube (■) near END flashes.

Tips: The final outcome may differ depending on the actual bread mix used. (There may be greater variation with wheat free bread mixes.)

Baking Brioche



Turn to P. 24 for recipes.

1 – 4 See P. 12 of Preparations

5 Select menu 10, choose crust colour.

6 Press button to start.

- Display shows the remaining time until the beep sounds.

7 After about 55 minutes. **Open the lid** when you hear the beep sound. **Add the additional butter while is flashing. Close the lid and restart.**

- Kneading will continue after 5 minutes without press button.

8 Press button and remove bread when machine beeps 8 times and the cube (■) near **END** flashes.

Tips: • Timer is not available on this menu.

- Do not add butter or extra ingredients after display shows remaining time.
- When adding extra ingredients such as raisins, add them with the butter in step 7. (Use max. 150 g for ingredients)

To bake brioche in simple way.

- Cut butter into 1 - 2 cm cubes and keep them in refrigerator.
- Place butter with other ingredients in the beginning and follow step 5.
- Skip step 7 process in this way. This Brioche is a little different from the others.

Sourdough & Sourdough Dough



Turn to P. 24, 28 for recipes.

STAGE 1 Making Sourdough Starter

Preparations:

- Mix all the ingredients well in the sourdough cup. (Remove the kneading blade)
- Put the lid on the sourdough cup.
- Place the sourdough cup in the bread pan.
- Set the bread pan into the main unit, and plug the machine into the socket.

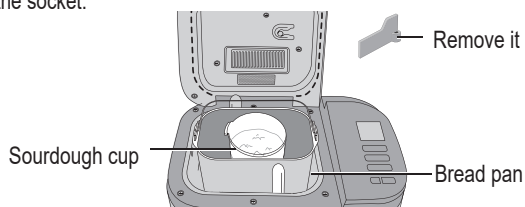

1 Select the menu

Sourdough Starter	
SD-YR2550	Menu 23
SD-R2530	Menu 22

2 Press button to start.

- Display shows the remaining time until the program is complete. (Take SD-YR2550 display as an example)



3 Press button and remove the sourdough cup immediately when machine beeps 8 times and the cube (■) near **END** flashes.

- When you do not use it immediately, store it in the refrigerator, but use up within 1 week.

STAGE 2 Baking/Making Sourdough

Preparations:

- Set the kneading blade into the bread pan.
- Pour a cup of sourdough starter into the bread pan.
- SD-YR2550**
 - Place the ingredients in the bread pan according to the order of recipe.
 - Place the dry yeast in the yeast dispenser.
- SD-R2530**
 - Place the ingredients 'listed in stage 2' in the bread pan in the following order: flour → salt → dry yeast (keep away from the salt) → water (keep away from the dry yeast, pour water around flour).
- Set the bread pan into the main unit, and plug the machine into the socket.

1 Select the menu

	Sourdough	Sourdough Dough
SD-YR2550	Menu 13	Menu 22
SD-R2530	Menu 12	Menu 21

2 Press button to start.

- Display shows the remaining time until the program is complete.

3 Press button and remove bread / dough, when machine beeps 8 times and the cube (■) near **END** flashes.

- Tips:** • **Timer is available for baking sourdough bread (up to 9 hours).**
- Shape the finish dough and allow it to rise until doubled in size, then bake in the oven.

To make or storage sourdough starter without failure.

- Do not select a wrong menu.
- Do not take out the sourdough cup until the program is complete.
- Do not mix the new sourdough starter with old one.
- If the sourdough starter is made well, it smells sour and like alcohol.
- When the room temperature is over 30 °C, the sourdough starter goes bad, and the bread does not turn out well.

Handling Instructions

Gluten Free Information

Making gluten free bread is very different from the normal way of producing bread.

It is very important if you are making gluten free bread for health reasons that you have consulted your doctor and follow the guidelines below.

- This program has been developed especially for certain gluten free ingredients, therefore using your own mix may not produce such good results.
- Gluten free bread cannot rise as much as a traditional bread. It will be of a denser consistency and lighter colour than normal bread.
- When "gluten free" is selected, the details for each recipe must be followed carefully. (Otherwise, the bread may not turn out well.)

The Gluten Free mode can be / should be used for baking both Gluten Free and Wheat Free recipes.

- The baking results and bread's appearance may differ according to the type of mix. Occasionally a bread may have some flour remaining on the side. The wheat free mixes can produce more variable results.
- Wait for the bread to cool before slicing it for the better performance.
- The bread should be stored in a cool dry place and used within 2 days. If you will not be able to use up all the bread within that time it can be put into freezer bags, in convenient sized portions, and frozen.

Warning for the users who use this program for health reasons:

When using the gluten free program, make sure to consult your doctor and only use the ingredients that are gluten free.

Panasonic will not be responsible for any consequences resulting from ingredients that have been used without professional consultation.

It is very important to avoid cross contamination with flours that contain gluten if bread is being made for dietary reasons. Particular attention must be paid to the cleaning of the bread pan and kneading blade as well as any utensils that are used. You must also ensure that the yeast used contains no gluten.

Baking Gluten Free Bread



Turn to P. 25 for recipes.

1 – 4 See P. 12 of Preparations

5 Select the menu

Gluten Free Bread	
SD-YR2550	Menu 14
SD-R2530	Menu 13

6 Press button to start.

- Display shows the remaining time until the beep sounds.

7 After about 6 minutes, **open the lid** when you hear the beep sound. **Scrape off the flour within 3 minutes while is flashing. Close the lid and restart.**

- Kneading will continue after 3 minutes without press button.

8 Press button and remove bread when machine beeps 8 times and the cube () near **END** flashes.

Tips: Use a rubber spatula to avoid damaging the bread pan. Do not use the metal spatula.

Baking Gluten Free Cake



Turn to P. 25 for recipes.

1 – 4 See P. 12 of Preparations

5 Select the menu

Gluten Free Cake	
SD-YR2550	Menu 15
SD-R2530	Menu 14

6 Press button to start.

- Display shows the remaining time until the beep sounds.

7 After about 2 minutes, **open the lid** when you hear the beep sound. **Scrape off the flour within 3 minutes while is flashing. Close the lid and restart.**

- Kneading will continue after 3 minutes without press button.

8 After about 12 minutes, **open the lid** when you hear the beep sound. **Scrape off the dough on the sidewall of bread pan while is flashing. Close the lid and restart.**

- Baking will start after 3 minutes without press button.

9 Press button and remove cake when machine beeps 8 times and the cube () near **END** flashes.

Tips

- Use a rubber spatula to avoid damaging the bread pan. Do not use metal spatula.
- If you shake hard to remove cake from the bread pan, it will lose shape.

Making Gluten Free Pizza / Gluten Free Pasta



Turn to P. 26 for recipes.

1 – 4 See P. 12 of Preparations

5 Select the menu

	Gluten Free Pizza	Gluten Free Pasta
SD-YR2550	Menu 16	Menu 17
SD-R2530	Menu 15	Menu 16

6 Press button to start.

- Display shows the remaining time until the beep sounds.

7 After about 5 minutes for gluten free pizza, 2 minutes for gluten free pasta, **open the lid** when you hear the beep sound. **Scrape off the flour within 3 minutes while is flashing. Close the lid and restart.**

- Kneading will continue after 3 minutes without press button.

8 Press button and remove dough when machine beeps 8 times and the cube () near **END** flashes.

Gluten Free Pizza

9 Divide the dough into 2 parts with scraper, and roll them into a circle of about 20 cm diameter.

10 Spread your favourite sauce and desired topping then bake it in the oven.

Gluten Free Pasta

9 Wrap the dough in a cling film and rest for 1 hour in the refrigerator.

10 Lightly flour the dough surface, and shape it to your desired shapes.

11 Boil them and enjoy it with your favourite sauce.

- Tips:** Use the rubber spatula to avoid damaging the bread pan. Do not use the metal spatula.

Baking Cake



Turn to P. 29 for recipes.

1 - 4 See P. 12 of Preparations

5 Select the menu

	Cake
SD-YR2550	Menu 25
SD-R2530	Menu 24

6 Press button to start.

- Display shows the remaining time until the beep sounds.

7 After about 12 minutes, **open the lid** when you hear the beep sound. **Scrape off the flour within 5 minutes while is flashing. Close the lid and restart.**

- Kneading will continue after 5 minutes without pressing button.

8 Press button and remove cake when machine beeps 8 times and the cube () near **END** flashes.

Additional Baking

- If baking is not complete, follow the following method. (Additional baking time can be made up to twice within 20 minutes while the machine is still hot. The timer will start again from 1 minute by pressing the button as required.)

- ① Select the menu (Skip it if you have not pressed button in step 8)
- ② Set the baking time
 - It can be set to 1 - 20 minutes.
- ③ Press button to start.
 - To discontinue baking, hold button.

Tips:

- Timer is not available on this menu. It only sets the duration of the baking time.
- Use a rubber spatula to avoid damaging the bread pan. Do not use metal spatula.
- If you shake hard to remove cake from the bread pan, it will lose shape.

Handling Instructions

Bake Only



Turn to P. 29 for recipes.

Preparations:

- ① Prepare the mixed ingredients in the bowl according to the recipe.
- ② Remove the kneading blade and line the greaseproof paper around the bread pan, then pour in the mixed ingredients.
- ③ Set the bread pan into the main unit, and plug the machine into the socket.

1 Select the menu

	Bake Only
SD-YR2550	Menu 26
SD-R2530	Menu 25

2 Set the baking time

3 Press button to start.

- Display shows the remaining time until the program is complete.

- ### 4 Press button and remove cake when machine beeps 8 times and the cube (■) near END flashes.

Additional Baking

- If baking is not complete, repeat step 1–4. (Additional baking time can be made up to twice within 50 minutes while the machine is still hot. The timer will start again from 1 minute by pressing the  button as required.)

Tips: Timer is not available on this menu. It only sets the duration of the baking time.

Making Jam / Compote



Turn to P. 29 for recipes.

Preparations for Jam-making

- ① Prepare the ingredients according to the recipe.
- ② Put the kneading blade into the bread pan.
- ③ Place the ingredients into the pan in following order.
half of fruits → half of sugar → remainder of fruits → remainder of sugar.
- ④ Set the bread pan into the main unit, and plug the machine into the socket.

Preparations for Compote-making

- ① Prepare the ingredients according to the recipe. (Remove the kneading blade.)
- ② Place the ingredients into the bread pan according to the order of recipes, pour water over ingredients.
- ③ Set the bread pan into the main unit, and plug the machine into the socket.

1 Select the menu

	Jam	Compote
SD-YR2550	Menu 27	Menu 28
SD-R2530	Menu 26	Menu 27

2 Set the cooking time, then start the machine.

- ### 3 Press button and remove Jam / Compote when machine beeps 8 times and the cube (■) near END flashes.

Additional Cooking

- If the cooking is not complete → repeat step 1 - 3. (Additional cooking time can be made up to twice within 10 - 40 minutes while the machine is still hot. The timer will start again from 1 minute by pressing the  button as required.)

Tips:

- Timer is not available on these menus. It only sets the duration of the cooking time.
- Strictly follow the recipe for the amount of each ingredients. Otherwise, the jam does not set firm, to be boiled over or scorched as well as the compote.

Tips for Jam-making

- It's necessary to have an adequate amount of sugar, acid and pectin to make firm set jam.
- Fruits with a high level of pectin set easily. Fruits with less pectin do not set well.
- Use freshly ripened fruits. Over or under ripe fruits do not set firmly.
- The recipes in this instructions make soft set jams due to using less sugar.
- When cooking time is short, fruit bits can remain partially and the jam may become watery.
- Jam will continue to set as it cools. Be careful not to over cook.
- Put the finished jam into the container as soon as possible. Take care not to burn when you take out jam.
- Jam can be burned if it is left in the bread pan.
- Store the jam in a cool, dark place. Due to the lower levels of sugar the shelf life is not as long as shop bought varieties. Once open, refrigerate and consume shortly after opening.

Cake Kneading



Turn to P. 30 for recipes.

Preparations:

- ① Remove the bread pan and set the kneading blade.
- ② Place the measured ingredients in the bread pan.
- ③ Return the bread pan to the main unit. Close the lid and plug in.

1 Select the menu

Cake Kneading	
SD-YR2550	Menu 29
SD-R2530	Menu 28

2 Set the kneading time (Default: 20 minutes)

3 Press button to start.

- Display shows the remaining time until the program is complete.

4 Press button and remove the dough when machine beeps 8 times and the cube (■) near END flashes.

5 Put it into cake mold, then bake in a preheated oven.

Tips: Use a rubber spatula to avoid damaging the bread pan. Do not use metal spatula.

Bread Kneading



Turn to P. 30 for recipes.

Preparations:

- ① Remove the bread pan and set the kneading blade.
- ② Place the measured ingredients in the bread pan.
- ③ Return the bread pan to the main unit. Close the lid and plug in.

1 Select the menu

Bread Kneading	
SD-YR2550	Menu 30
SD-R2530	Menu 29

2 Set the kneading time

- Please set the time according to the bread dough which is used for primary fermentation. (Default: 20 minutes)

3 Press button to start.

- Display shows the remaining time until the program is complete.

4 Press button and remove the dough when machine beeps 8 times and the cube (■) near END flashes.

Tips:

- Rest for over 20 minutes before the next kneading starts.
- For the case of hard dough or much amount of dough, "U50" may appear on the display. Leave a little time to restart the next kneading. The amount of flour that can be used is up to 400 - 600 g.

Rise



Turn to P. 30 for recipes.

Preparations:

- ① Remove the kneading blade and place the dough into the bread pan.
- ② Return the bread pan to the main unit. Close the lid and plug in.

1 Select the menu

Rise	
SD-YR2550	Menu 31
SD-R2530	Menu 30

2 Set the time (use the primary fermentation of kneaded dough. Set the time according to the bread dough.) (Default: 30 minutes)

3 Press button to start.

- Display shows the remaining time until the program is complete.

4 Press button and remove the dough when machine beeps 8 times and the cube (■) near END flashes.

5 Shape the finished dough and allow it to rise in the oven, then bake.

Recipes

Customers who live in Australia

Use the recipes from the amount in the table described as (OZ).

- To raise bread, use strong high protein flour (Bread flour or Bakers flour).
- Bread improver contain Vitamin C, and there is an effect to improve volume of bread.
Please add it at the time of the recipe which using a lot of whole wheat flour.
- When using ORGRAN for gluten free bread, upper side comes to dent easily.
- When using ORGRAN for gluten free bread, always use chilled water.

Customers who live in New Zealand

Use the recipes from the amount in the table described as (NZ).

For the case of using instant dry yeast, make the bread referring to the recipe for OZ

- To raise the bread, the HIGH GRADE FLOUR is recommended.
When lower grade flour is used, the bread may rise less and the loaf may be smaller.
- The Red Top SUREBAKE yeast is recommended for yeast.
SUREBAKE yeast is a blend of Active Dry Yeast and Bread Improvers for easy bread making. Usually Bread Improver (Vitamin C) is not needed;
- Please note that a wheat element has been added to SUREBAKE yeast.
- Using the timer option in conjunction with the Pizza Dough program is not recommended as the melted yeast will begin acting straight away.
Do not melt the yeast when using any other program than Pizza Dough program.
- Baking Rapid program: Please note that when this program is used, due to the shortened baking cycle (2 hours - 3 hours) the loaf may not rise or be baked to the same degree as a loaf cooked using the full baking cycle. To ensure that your loaf rises fully, it is recommended that the Baking Rapid program (Menu 2 or 8) is not used.

Example

Recipe Name

Menu No.+Total process time + Option icon

The options of each recipe and necessary operation are indicated as the following icons.

Option icon

Light crust Medium crust Dark crust Delay timer

Necessary operation icon

- ★ SD-YR2550: Place measured dry yeast into yeast dispenser.
Place measured SUREBAKE yeast into bread pan first.
- SD-R2530: Place measured dry yeast/SUREBAKE yeast into bread pan first.

Place measured ingredients into bread pan in the order listed in the recipe.

Add additional ingredients into raisin nut dispenser.

Do manual operation (such as adding extra ingredients, scraping the flour from sidewall of bread pan) when the beep sounds.

	M	L	XL
★ Dry yeast (OZ) / SUREBAKE yeast (NZ)	2 tsp	2 tsp	2½ tsp
Bread flour (OZ) / White flour (NZ)	400 g	500 g	600 g
Egg (L), beaten	1	1	2
Sunflower seeds	50 g	65 g	75 g
Cheese	50 g	65 g	75 g

Abbreviation:

tsp = tea spoon; tbsp = table spoon

Egg (L) = Egg in large size; Egg (M) = Egg in medium size.

Bread Recipes

Turn to P. 12 - 14 for handling instructions.

Basic Menu 1

White Loaf

(4 h - 4 h 5 min)

(OZ)	M	L	XL
★ Dry yeast	1¼ tsp	1½ tsp	1½ tsp
Bread flour	420 g	520 g	620 g
Butter	15 g	20 g	25 g
Sugar	1 tbsp	1 tbsp	1½ tbsp
Powdered milk	2 tsp	1½ tbsp	1¼ tbsp
Salt	1 tsp	2 tsp	2 tsp
Water	290 mL	360 mL	420 mL

(NZ)	M	L	XL
SUREBAKE yeast *	2 tsp	2½ tsp	3 tsp
White bread	350 g	450 g	600 g
Butter	15 g	25 g	25 g
Sugar	1 tsp	1 tsp	2 tsp
Milk powder	1 tbsp	2 tbsp	3 tbsp
Salt	1 tsp	1½ tsp	1½ tsp
Water	260 mL	330 mL	420 mL

Milk Loaf



(4 h - 4 h 5 min)

(OZ)	M	L	XL
★ Dry yeast	1¼ tsp	1½ tsp	1½ tsp
White bread	420 g	520 g	620 g
Butter	15 g	20 g	25 g
Sugar	1 tbsp	1 tbsp	1½ tbsp
Powdered milk	2 tsp	1½ tbsp	1¼ tbsp
Salt	1 tsp	2 tsp	2 tsp
Milk	300 mL	370 mL	440 mL

* If you are a New Zealand customer using instant dry yeast please refer to the OZ recipe.

Basic Rapid Menu 2

Rapid White Loaf

(1 h 55 min – 2 h)   

(OZ)	M	L	XL
★ Dry yeast	1½ tsp	2¼ tsp	2¼ tsp
Bread flour	420 g	520 g	620 g
Butter	15 g	20 g	25 g
Sugar	1 tbsp	2 tbsp	2 tbsp
Powdered milk	1 tbsp	1½ tbsp	2 tbsp
Salt	1½ tsp	2 tsp	2 tsp
Water	290 mL	360 mL	430 mL

Italian Bread

(1 h 55 min) 

(OZ)	M
★ Dry yeast	1½ tsp
Bread flour	400 g
Olive oil	1 tbsp
Salt	1½ tsp
Water	260 mL

Basic Raisin Menu 3

Raisin Loaf

(4 h)   

(OZ)	M	L	XL
★ Dry yeast	1¼ tsp	1½ tsp	1½ tsp
Bread flour	420 g	520 g	620 g
Butter	15 g	20 g	25 g
Sugar	1 tbsp	1 tbsp	1½ tbsp
Powdered milk	2 tsp	1½ tbsp	1¼ tbsp
Salt	1 tsp	2 tsp	2 tsp
Milk	290 mL	360 mL	420 mL
Raisins *1	80 g	100 g	120 g

(NZ)	M	L	XL
SUREBAKE yeast *2	2 tsp	2½ tsp	3 tsp
White bread	350 g	450 g	600 g
Butter	15 g	25 g	25 g
Sugar	1 tsp	1 tsp	2 tsp
Milk powder	1 tbsp	2 tbsp	3 tbsp
Salt	1 tsp	1½ tsp	1½ tsp
Water	260 mL	330 mL	420 mL
Raisins *1	80 g	100 g	120 g

*1 Cut into approx. 5 mm cubes.

*2 If you are a New Zealand customer using instant dry yeast please refer to the OZ recipe.

5 Seeded Bread Loaf

(4 h)   

(OZ)	M	L	XL
★ Dry yeast	1¼ tsp	1½ tsp	1½ tsp
Bread flour	420 g	500 g	570 g
Butter	15 g	20 g	25 g
Sugar	1 tbsp	1 tbsp	1½ tbsp
Powdered milk	2 tsp	1½ tbsp	1¼ tbsp
Salt	1 tsp	2 tsp	2 tsp
Sesame seeds	1 tbsp	1½ tbsp	2 tbsp
Poppy seeds	1 tbsp	1½ tbsp	2 tbsp
Water	290 mL	340 mL	400 mL
Linseeds	1 tbsp	1½ tbsp	2 tbsp
Pumpkin seeds	1 tbsp	1½ tbsp	2 tbsp
Sunflower seeds	1 tbsp	1½ tbsp	2 tbsp

(NZ)	M	L	XL
SUREBAKE yeast *2	2 tsp	2½ tsp	3 tsp
White bread	350 g	425 g	550 g
Butter	15 g	25 g	25 g
Sugar	1 tbsp	1 tbsp	1½ tbsp
Milk powder	1 tbsp	2 tbsp	3 tbsp
Salt	1 tsp	1½ tsp	1½ tsp
Sesame seeds	1 tbsp	1½ tbsp	2 tbsp
Poppy seeds	1 tbsp	1½ tbsp	2 tbsp
Water	260 mL	310 mL	400 mL
Linseeds	1 tbsp	1½ tbsp	2 tbsp
Pumpkin seeds	1 tbsp	1½ tbsp	2 tbsp
Sunflower seeds	1 tbsp	1½ tbsp	2 tbsp

Basic Stuffed Menu 4

Bacon and Cheese Loaf

(4 h – 4 h 5 min)   

(OZ)	M	L	XL
★ Dry yeast	1¼ tsp	1½ tsp	1½ tsp
Bread flour	420 g	520 g	600 g
Butter	15 g	20 g	25 g
Sugar	1 tbsp	1 tbsp	1½ tbsp
Powdered milk	2 tsp	1½ tbsp	1¼ tbsp
Salt	1 tsp	2 tsp	2 tsp
Water	290 mL	360 mL	410 mL
Cooked bacon *1	50 g	65 g	75 g
Cheese *1	50 g	60 g	75 g

(NZ)	M	L	XL
SUREBAKE yeast *2	2 tsp	2½ tsp	3 tsp
Bread flour	350 g	450 g	580 g
Butter	15 g	25 g	25 g
Sugar	1 tsp	1 tsp	2 tsp
Milk powder	1 tbsp	2 tbsp	3 tbsp
Salt	1 tsp	1½ tsp	1½ tsp
Water	260 mL	330 mL	400 mL
Cooked bacon *1	50 g	65 g	75 g
Cheese *1	50 g	60 g	75 g

*1 Cut into approx. 5 mm cubes.

*2 If you are a New Zealand customer using instant dry yeast please refer to the OZ recipe.

Recipes

Bread Recipes



Turn to P. 12 - 14 for handling instructions.

Basic Stuffed Menu 4

Sundried Tomato, Olive and Tomato Juice

(4 h - 4 h 5 min) (OZ)

	M	L	XL
★ Dry yeast	1½ tsp	1½ tsp	1½ tsp
Bread flour	420 g	520 g	600 g
Butter	15 g	20 g	25 g
Sugar	1 tbsp	1 tbsp	1½ tbsp
Powdered milk	2 tsp	1½ tbsp	1½ tbsp
Salt	1 tsp	2 tsp	2 tsp
Water	145 mL	180 mL	200 mL
Tomato juice	145 mL	180 mL	210 mL
Olive	70 g	85 g	100 g
Sundried tomatoes in oil, chopped	30 g	40 g	50 g

(NZ)

	M	L	XL
SUREBAKE yeast *	2 tsp	2½ tsp	3 tsp
White flour	350 g	450 g	580 g
Butter	15 g	25 g	25 g
Sugar	1 tsp	1 tsp	2 tsp
Milk powder	1 tbsp	2 tbsp	3 tbsp
Salt	1 tsp	1½ tsp	1½ tsp
Water	130 mL	165 mL	200 mL
Tomato juice	130 mL	165 mL	200 mL
Olive	70 g	85 g	100 g
Sundried tomatoes in oil, chopped	30 g	40 g	50 g

* If you are a New Zealand customer using instant dry yeast please refer to the OZ recipe.

Bread Mix Menu 5

Bread Mix

(2 h 30 min) (OZ) / (NZ)

Mix flour *1	500 g
Water *2	300 mL

*1 Bread mix for white loaf only. Follow the recipes on the package of bread mix.

*2 As shown on packet needs to be added.

Vegetable Juice Bread

(2 h 30 min) (OZ) / (NZ)

Mix flour *1	500 g
Water *3	150 mL
Vegetable juice *3	150 mL

*3 Half the specified amount of water for bread mix.

Bread Mix Raisin Menu 6

Bread Mix Raisin

(2 h 30 min) (OZ) / (NZ)

Mix flour *1	500 g
Water *2	300 mL
Raisins *3	100 g

*1 Bread mix for white loaf only. Follow the recipes on the package of bread mix.

*2 As shown on packet needs to be added.

Matcha Sweet Chestnut Loaf

(2 h 30 min) (OZ) / (NZ)

Mix flour *1	500 g
Matcha	10 g
Water *2	300 mL
Sweet chestnut *3	100 g

*3 Cut into approx. 5 mm cubes.

Whole Wheat Menu 7

Wholemeal Loaf 75%

(5 h) (OZ)

	M	L	XL
★ Dry yeast	1½ tsp	1½ tsp	1½ tsp
Whole wheat flour	300 g	370 g	450 g
Bread flour	100 g	125 g	150 g
Butter	15 g	20 g	25 g
Sugar	1 tbsp	1½ tbsp	1½ tbsp
Powdered milk	2 tsp	1½ tbsp	1½ tbsp
Salt	1 tsp	2 tsp	2 tsp
Bread improver, optional	¼ tsp	½ tsp	½ tsp
Water	300 mL	360 mL	420 mL

Wholemeal Loaf 100%

(5 h) (NZ)

	M	L	XL
SUREBAKE yeast *	2 tsp	3 tsp	3½ tsp
Wholemeal flour	350 g	450 g	600 g
Gluten flour	1 tbsp	1 tbsp	1½ tbsp
Butter	15 g	25 g	25 g
Treacle	1 tbsp	1 tbsp	2 tbsp
Milk powder	1 tbsp	2 tbsp	3 tbsp
Salt	1 tsp	1 tsp	1 tsp
Water	280 mL	340 mL	430 mL

* If you are a New Zealand customer using instant dry yeast please refer to the OZ recipe.

Whole Wheat Menu 7

Oat and Bran Loaf

(5 h) ⌚

(OZ)	L
★ Dry yeast	1½ tsp
Bread flour	420 g
Bran	50 g
Porridge oats	50 g
Oil	2 tbsp
Sugar	1 tbsp
Salt	2 tsp
Water	360 mL

(NZ)	L
SUREBAKE yeast *	2½ tsp
White flour	350 g
Bran	50 g
Porridge oats	50 g
Oil	2 tbsp
Sugar	1 tsp
Salt	1½ tsp
Water	330 mL

* If you are a New Zealand customer using instant dry yeast please refer to the OZ recipe.

Whole Wheat Rapid Menu 8

Rapid Wholemeal Loaf 75%

(3 h)

(OZ)	M	L	XL
★ Dry yeast	1½ tsp	2 tsp	2½ tsp
Whole wheat flour	300 g	370 g	450 g
Bread flour	100 g	125 g	150 g
Butter	15 g	20 g	25 g
Sugar	½ tbsp	1 tbsp	2 tbsp
Powdered milk	1 tbsp	1 tbsp	1½ tbsp
Salt	1½ tsp	2 tsp	2 tsp
Bread improver, optional	¼ tsp	½ tsp	½ tsp
Water	300 mL	350 mL	420 mL

Rapid Wholemeal Loaf 50%

(3 h)

(OZ)	M	L	XL
★ Dry yeast	1½ tsp	2 tsp	2½ tsp
Whole wheat flour	200 g	250 g	300 g
Bread flour	200 g	250 g	300 g
Butter	15 g	20 g	25 g
Sugar	½ tbsp	1 tbsp	2 tbsp
Powdered milk	1 tbsp	1 tbsp	1½ tbsp
Salt	1½ tsp	2 tsp	2 tsp
Bread improver, optional	¼ tsp	½ tsp	½ tsp
Water	300 mL	350 mL	420 mL

Whole Wheat Raisin Menu 9

Wholemeal Raisin Loaf 75%

(5 h) ⌚

(OZ)	M	L	XL
★ Dry yeast	1¼ tsp	1½ tsp	1¾ tsp
Whole wheat flour	300 g	370 g	450 g
Bread flour	100 g	125 g	150 g
Butter	15 g	20 g	25 g
Sugar	1 tbsp	1 tbsp	1½ tbsp
Powdered milk	2 tsp	1½ tbsp	1¾ tbsp
Salt	1 tsp	2 tsp	2 tsp
Bread improver, optional	¼ tsp	½ tsp	½ tsp
Water	300 mL	360 mL	420 mL
Raisins *1	80 g	100 g	120 g

Maple and Pecan Nut Loaf

(5 h) ⌚

(OZ)	M
★ Dry yeast	1½ tsp
Whole wheat flour	200 g
Bread flour	200 g
Butter	15 g
Maple syrup	3 tbsp
Powdered milk	2 tsp
Salt	1 tsp
Bread improver, optional	¼ tsp
Water	300 mL
Pecan nuts *1	75 g

Wholemeal Raisin Loaf 100%

(5 h) ⌚

(NZ)	M	L	XL
SUREBAKE yeast *2	2 tsp	3 tsp	3½ tsp
Wholemeal flour	350 g	450 g	600 g
Gluten flour	1 tbsp	1 tbsp	1½ tbsp
Butter	15 g	25 g	25 g
Treacle	1 tbsp	1 tbsp	2 tbsp
Milk powder	1 tbsp	2 tbsp	3 tbsp
Salt	1 tsp	1 tsp	1 tsp
Water	280 mL	340 mL	430 mL
Raisins *1	80 g	100 g	120 g

(NZ)	M
SUREBAKE yeast *2	2 tsp
Wholemeal flour	175 g
White flour	175 g
Butter	15 g
Maple syrup	3 tbsp
Milk powder	1 tbsp
Salt	1 tsp
Water	270 mL
Pecan nuts *1	75 g

*1 Cut into approx. 5 mm cubes.

*2 If you are a New Zealand customer using instant dry yeast please refer to the OZ recipe.

Recipes

Bread Recipes



Turn to P. 12 - 15 for handling instructions.

Brioche Menu 10

Basic Brioche

(3 h 30 min)

(OZ)

★	Dry yeast	1¼ tsp
	Bread flour	400 g
	Butter *1	60 g
	Sugar	50 g
	Powdered milk	2 tbsp
	Salt	1½ tsp
	Mixture / beat 2 eggs (M) + 2 egg yolk + water	270 mL
	Butter *2	80 g

* 1 Cut into 2 - 3 cm cubes and keep in refrigerator.

* 2 Cut into 1 - 2 cm cubes and keep in refrigerator.

* 3 Cut into approx. 5 mm cubes.

Panettone

(3 h 30 min)

(OZ)

★	Dry yeast	1¼ tsp
	Bread flour	400 g
	Butter *1	60 g
	Sugar	50 g
	Salt	1½ tsp
	Mixture / beat 2 eggs (M) + 2 egg yolk + water	290 mL
	Butter *2	60 g
	Candied orange peel *3	50 g
	Sultanas *3	50 g
	Currants *3	50 g

French Menu 11

French

(5 h 40 min)

	(OZ)	(NZ)
★	Dry yeast (OZ)/SUREBAKE yeast (NZ) *	1 tsp / 3 tsp
	Bread flour (OZ)/White flour (NZ)	400 g / 400 g
	Salt	1½ tsp / 1½ tsp
	Water	290 mL / 290 mL

* If you are a New Zealand customer using instant dry yeast please refer to the OZ recipe.

Pain de Campagne

(5 h 40 min)

	(OZ)	(NZ)
★	Dry yeast (OZ)/SUREBAKE yeast (NZ) *	1 tsp / 3 tsp
	Bread flour (OZ)/White flour (NZ)	320 g / 320 g
	Whole wheat flour (OZ)/Wholemeal flour (NZ)	80 g / 80 g
	Salt	1½ tsp / 1½ tsp
	Cold water (5 °C)	300 mL / 300 mL

Rye Menu 12

Rye 100%

(3 h 30 min)

(OZ)

★	Dry yeast	3 tsp
	Rye flour	500 g
	Oil	3 tbsp
	Sugar	2 tsp
	Salt	2 tsp
	Water	380 mL

● Use kneading blade for rye menu.

Rye and White

(3 h 30 min)

(OZ)

★	Dry yeast	2½ tsp
	Rye flour	250 g
	Bread flour	250 g
	Oil	2 tbsp
	Sugar	2 tsp
	Salt	2 tsp
	Water	380 mL

Sourdough Menu 13 (SD-R2530: 12)

Sourdough Bread

Stage 1: Sourdough Starter: Menu 23 (24 h)

Turn to P. 28 for the recipe.

Stage 2: Menu 13 (SD-R2530: 12) (5 h)

(OZ)

	Sourdough starter	1 cup
	Bread flour	400 g
	Salt	1 tsp
	Water	150 mL
	Dry yeast *1	¼ tsp

*1 For SD-YR2550, place dry yeast into the yeast dispenser.

(NZ)

	Sourdough starter	1 cup
	White flour	400 g
	Salt	1 tsp
	Water	150 mL
	SUREBAKE yeast *2	2¼ tsp

*2 If you are a New Zealand customer using instant dry yeast please refer to the OZ recipe.

Gluten Free Recipes



Gluten Free Bread Menu 14 (SD-R2530: 13)

Wheat and Gluten Free Bread

(1 h 50 min - 1 h 55 min)  

(OZ)

	Water (chilled)	450 mL
	Vegetable oil	3 tbsp
	ORGRAN Easy Bake Bread Mix	450 g

(NZ)

	Water	430 mL
	Vegetable oil	60 mL
	Healthies Simple Bread Mix	500 g
	Instant yeast (gluten free yeast)	1¼ tsp

For more information on ORGRAN's gluten free bread mixes, please contact the address below:



NATURAL FOODS

Division of Roma Food Products, 47-53 Aster Avenue, Carrum Downs, Victoria 3201

Gluten Free Bread

(1 h 50 min - 1 h 55 min)  

(OZ) / (NZ)

	Milk	310 mL
	Eggs (M), beaten	2 (100 g)
	Cider vinegar	1 tbsp
	Oil	2 tbsp
	Honey	60 g
	Salt	1¼ tsp
	Brown rice flour	150 g
	Potato starch	300 g
	Xanthan gum	2 tsp
	Dry yeast (OZ) / Instant yeast (gluten free yeast) (NZ)	2½ tsp

Tips

- The outcome differs depending on the recipes or using type of bread mix.
- Follow the recipes on the package of your gluten free bread mix.

Flavoured Gluten Free Loaves

Use one quantity of chosen mix and add the following ingredients to your bread pan to produce the loaf of your choice.

Spicy Fruit Loaf

(1 h 50 min) 

Mixed fruits	100 g
Cinnamon	2 tsp

Sundried Tomato & Parmesan Loaf

(1 h 55 min) 

Parmesan cheese grated	50 g
Sundried tomatoes in oil, drained and chopped	50 g

Maple & Pecan Loaf

(1 h 55 min) 

Maple syrup	2 tbsp
Pecans	50 g

Five Seeds Loaf

(1 h 55 min) 

Linseeds	1 tbsp
Sesame seeds	2 tbsp
Pumpkin seeds	1 tbsp
Poppy seeds	1 tbsp
Sunflower seeds	1 tbsp

Date & Raisin Loaf

(1 h 55 min) 

Juice of oranges *	2
Mixed spice	2 tsp
Dates, chopped	150 g
Raisins	100 g
Zest of oranges	2

* made up to the quantity of water required, and place it in the bread pan before gluten free mix.

Gluten Free Cake Menu 15 (SD-R2530: 14)

Gluten Free Chocolate Cake

(1 h 50 min)

(OZ) / (NZ)

	Butter *1	150 g
	Sugar	150 g
	Eggs (L), beaten	3 (180 g)
	Dark chocolate, melted	120 g
	White rice flour	120 g
	Cacao powder	30 g
	Gluten Free Baking Powder	10 g

Gluten Free Tea Cake

(1 h 50 min)

(OZ) / (NZ)

	Butter *1	80 g
	Sugar	160 g
	Eggs (L), beaten	3 (180 g)
	White rice flour	160 g
	Ground almonds	80 g
	Tea leaves, chopped	2 tsp
	Gluten Free Baking Powder	10 g

Gluten Free Banana Cake

(1 h 50 min)

(OZ) / (NZ)

	Butter *1	80 g
	Sugar	120 g
	Eggs (L), beaten	3 (180 g)
	White rice flour	160 g
	Ground almonds	50 g
	Banana *2	80 g
	Gluten Free Baking Powder	10 g

*1 Cut into 1 cm cubes.

*2 Cut into 1 - 2 cm.

Recipes

Gluten Free Recipes



Turn to P. 12, 17 for handling instructions.

Gluten Free Pizza Menu 16 (SD-R2530: 15)

Gluten Free Pizza

(30 min)

(OZ) / (NZ)

Water	380 mL
White rice flour	475 g
Vegetable oil	1¼ tbsp
Salt	1 tsp
Dry yeast /Instant yeast (gluten free yeast) (NZ)	1 tsp

Gluten Free Pasta Menu 17 (SD-R2530: 16)

Gluten Free Pasta

(15 min)

(OZ) / (NZ)

Mixture / beat 2 eggs (M) + water	260 g
White rice flour	220 g
Potato starch	80 g
Corn starch	100 g
Xanthan gum	1½ tbsp
Oil	2 tbsp
Salt	1 tsp

(mixed and sifted)

- Be sure to whisk eggs and water together until very smooth.
- Place flour, starch and gum into another bowl and mix well.

Dough Recipes



Turn to P. 12 - 15 for handling instructions.

Basic Menu 18 (SD-R2530: 17)

Basic Dough

(2 h 20 min)

	(OZ)	(NZ)
★ Dry yeast (OZ)/SUREBAKE yeast (NZ) *1	2 tsp	3 tsp
Bread flour (OZ)/White flour (NZ)	475 g	450 g
Butter	45 g	50 g
Sugar	1¼ tbsp	1½ tsp
Powdered milk (OZ)/Milk powder (NZ)	3 tbsp	3 tbsp
Salt	2 tsp	1 tsp
Water	300 mL	270 mL

Soft Rolls / Baps

(2 h 20 min)

	(OZ)	(NZ)
★ Dry yeast (OZ)/SUREBAKE yeast (NZ) *1	2 tsp	3 tsp
Bread flour (OZ)/White flour (NZ)	450 g	450 g
Butter	30 g	30 g
Sugar	1 tbsp	1 tbsp
Salt	1 tsp	1 tsp
Egg (M), beaten	1 (50 g)	1 (50 g)
Water *2	250 mL	250 mL

*1 If you are a New Zealand customer using instant dry yeast please refer to the OZ recipe.

*2 For a slightly denser roll try 125 mL water and 125 mL milk.

- 1 Place the ingredients into the bread pan in the order listed above.
- 2 Select the menu.
- 3 Divide dough into 8 – 10 pieces and shape into baps.
- 4 Place on a greased baking tray and allow to prove at 40 °C until doubled in size (approx. 20 minutes).
- 5 Dust with flour.
- 6 Bake in a preheated oven at 220 °C for 15 minutes or until golden brown.

Basic Raisin Menu 19 (SD-R2530: 18)

Basic Raisin Dough

(2 h 20 min)

	(OZ)	(NZ)
★ Dry yeast (OZ)/SUREBAKE yeast (NZ) *1	2 tsp	3 tsp
Bread flour (OZ)/White flour (NZ)	475 g	450 g
Butter	45 g	50 g
Sugar	1¼ tbsp	1½ tsp
Powdered milk (OZ)/Milk powder (NZ)	3 tbsp	3 tbsp
Salt	2 tsp	1 tsp
Water	300 mL	270 mL
Raisins *2	100 g	100 g

Hot Cross Buns

(2 h 20 min)

	(OZ)	(NZ)
★ Dry yeast (OZ)/SUREBAKE yeast (NZ) *1	1 tsp	1 tsp
Bread flour (OZ)/White flour (NZ)	250 g	250 g
Butter	25 g	25 g
Sugar	1 tsp	1 tsp
Powdered milk (OZ)/Milk powder (NZ)	1 tbsp	1 tbsp
Salt	½ tsp	½ tsp
Cinnamon	1 tsp	1 tsp
Mixed spice	½ tsp	½ tsp
Egg (M), beaten	1 (50 g)	1 (50 g)
Water	100 mL	100 mL
Mixed dried fruits *2	100 g	100 g

*1 If you are a New Zealand customer using instant dry yeast please refer to the OZ recipe.

*2 Cut into approx. 5 mm cubes.

- 1 Divide mixture into 8 balls. Place on a lightly greased baking tray and allow to prove at 40 °C until doubled in size (approx. 20 minutes). Make a paste with approx. 2 tbsp flour mixed with 2 tbsp water and pipe a cross over the buns, or top with thin slices of short crust pastry.
- 2 Bake in a preheated oven at 220 °C for 15 – 20 minutes or until golden brown.
- 3 While still HOT, brush with a sugar glaze — 40 g sugar in 4 tbsp water, boiled until a syrup is reached - (approx. 5 minutes).

Whole Wheat Menu 20 (SD-R2530: 19)

Wholemeal Dough 75%

(3 h 15 min)

(OZ)

★	Dry yeast	2 tsp
	Whole wheat flour	370 g
	Bread flour	125 g
	Butter	20 g
	Sugar	1 tbsp
	Powdered milk	1½ tbsp
	Salt	2 tsp
	Bread improver, optional	½ tsp
	Water	360 mL

(NZ)

	SUREBAKE yeast *	3 tsp
	Wholemeal flour	330 g
	White flour	120 g
	Butter	25 g
	Treacle	1 tbsp
	Milk powder	2 tbsp
	Salt	1 tsp
	Water	330 mL

Wholemeal Dough 50%

(3 h 15 min)

(OZ)

★	Dry yeast	2 tsp
	Whole wheat flour	250 g
	Bread flour	250 g
	Butter	20 g
	Sugar	1 tbsp
	Powdered milk	1½ tbsp
	Salt	2 tsp
	Bread improver, optional	½ tsp
	Water	360 mL

(NZ)

	SUREBAKE yeast *	3 tsp
	Wholemeal flour	225 g
	White flour	225 g
	Butter	30 g
	Treacle	1 tbsp
	Milk powder	2 tbsp
	Salt	1 tsp
	Water	330 mL



* If you are a New Zealand customer using instant dry yeast please refer to the OZ recipe.

Whole Wheat Raisin Menu 21 (SD-R2530: 20)



Wholemeal Raisin Dough 75%

(3 h 15 min)

(OZ)

★	Dry yeast	2 tsp
	Whole wheat flour	370 g
	Bread flour	125 g
	Butter	20 g
	Sugar	1 tbsp
	Powdered milk	1½ tbsp
	Salt	2 tsp
	Bread improver, optional	½ tsp
	Water	360 mL
	Raisins *1	100 g

(NZ)

	SUREBAKE yeast *2	3 tsp
	Wholemeal flour	330 g
	White flour	120 g
	Butter	25 g
	Treacle	1 tbsp
	Milk powder	2 tbsp
	Salt	1 tsp
	Water	330 mL
	Raisins *1	100 g



*1 Cut into approx. 5 mm cubes.

*2 If you are a New Zealand customer using instant dry yeast please refer to the OZ recipe.



Wholemeal Walnut Rolls 70%

(3 h 15 min)

(OZ)

★	Dry yeast	2 tsp
	Whole wheat flour	350 g
	Bread flour	100 g
	Medium oatmeal	50 g
	Oil	2 tbsp
	Maple syrup	2 tbsp
	Salt	2 tsp
	Bread improver, optional	½ tsp
	Water	350 mL
	Walnuts *1	100 g

(NZ)

	SUREBAKE yeast *2	3 tsp
	Wholemeal flour	320 g
	White flour	90 g
	Medium oatmeal	40 g
	Oil	2 tbsp
	Maple syrup	2 tbsp
	Salt	1 tsp
	Water	330 mL
	Walnuts *1	100 g

Recipes

Dough Recipes



Turn to P. 12 - 15 for handling instructions.

Sourdough Menu 22 (SD-R2530: 21)

Sourdough Dough (Rye)

Stage 1: Sourdough Starter: Menu 23 (SD-R2530: 22) (24 h)

Turn to P. 15 for the recipe.

Stage 2: Menu 22 (SD-R2530: 21) (2 h 30 min)

	(OZ)	(NZ)
Sourdough starter	1 cup	1 cup
Bread flour (OZ)/White flour (NZ)	360 g	360 g
Rye flour	40 g	40 g
Salt	1 tsp	1 tsp
Water	150 mL	150 mL
Dry yeast *1 (OZ)/SUREBAKE yeast (NZ) *2	¼ tsp	2¼ tsp

*1 For SD-YR2550, place dry yeast into the yeast dispenser.

*2 If you are a New Zealand customer using instant dry yeast please refer to the OZ recipe.

Sourdough Starter Menu 23 (SD-R2530: 22)

Sourdough Starter

(24 h)

The amount for a sourdough cup

	(OZ)	(NZ)
Rye flour	80 g	80 g
Salt	½ tsp	½ tsp
Plain yogurt	60 g	60 g
Water (20 °C)	80 mL	80 mL
Dry yeast (OZ)/SUREBAKE yeast (NZ) *1 *2	1 (0.1 g)	3 (0.3 g)

*1 Use the sourdough starter spoon provided

*2 If you are a New Zealand customer using instant dry yeast please refer to the OZ recipe.

Pizza Menu 24 (SD-R2530: 23)

Pizza

(45 min) ⌚

	(OZ)	(NZ)
★ Dry yeast (OZ)/SUREBAKE yeast *1 (NZ)	1 tsp	3 tsp *2
Bread flour (OZ)/White flour (NZ)	475 g	450 g
Olive oil	2 tbsp	5 tbsp
Sugar	1¾ tbsp	1 tsp
Powdered milk (OZ)	1 tbsp	-
Salt	1 tsp	1 tsp
Water	300 mL	230 mL *2

Focaccia

(45 min) ⌚

	(OZ)	(NZ)
★ Dry yeast (OZ)/SUREBAKE yeast *1 (NZ)	2 tsp	3 tsp *2
Bread flour (OZ)/White flour (NZ)	475 g	450 g
Olive oil (OZ) / Butter (NZ)	2 tbsp	15 g
Sugar	2 tbsp	1 tsp
Powdered milk (OZ)/Milk powder (NZ)	2 tbsp	1 tbsp
Salt	2 tsp	1 tsp
Water	300 mL	300 mL *2

- Roll and pat the dough into a 30 cm x 25 cm rectangle on a greased baking tray.
 - Make indentations over the whole dough using your fingertips.
 - Add your favourite toppings such as olives and tomatoes.
 - Allow to prove at 40 °C until doubled in size (approx. 30 minutes).
 - Drizzle with olive oil and bake in a preheated oven at 190 °C for 20 – 30 minutes or until golden at the edges and cooked well in the centre.
- Serve warm with pasta dishes.

Doughnut (using failed unfermented bread dough)

- Divide the dough into small pieces that are 35 g each and shape them into balls. Cover them with a small towel and place them still for 10 - 20 minutes.
- Roll them into thin round shape and press the dough with the doughnut mold.
- Allow the dough to ferment for 20 - 30 minutes (till it rises to double its original size) at a temperature of 30 - 35 °C.
- Deep-fry them at an oil temperature of 170 °C and sprinkle them with cinnamon and refined white sugar.

*1 If you are a New Zealand customer using instant dry yeast please refer to the OZ recipe.

*2 It needs to be melted before handling. Add the yeast to 30 mL of lukewarm water. Make sure that the amount of water is reduced by 30 mL.

Sweet Recipes



Turn to P. 17 -
18 for handling
instructions.

Cake Menu 25 (SD-R2530: 24)

Butter Cake

(1 h 55 min)



(OZ) / (NZ)

	Butter (cut into 1 cm cubes)	200 g
	Sugar	180 g
	Milk	2 tbsp
	Egg (M), beaten	4 (200 g)
	Plain flour (mixed and)	300 g
	Baking powder (sifted)	13 g

Tea Cake

(1 h 55 min)

(OZ) / (NZ)

	Butter (cut into 1 cm cubes)	200 g
	Sugar	180 g
	Milk	2 tbsp
	Egg (M), beaten	4 (200 g)
	Plain flour (mixed and)	300 g
	Baking powder (sifted)	13 g
	Earl gray tea (Tea leaf)	1 tbsp
	Dried fruits *	100 g

* Add it when scraping off the flour in step 7.

Bake Only Menu 26 (SD-R2530: 25)

Cherry & Marzipan Cake

Timer: 1 h

(OZ) / (NZ)

	Golden caster sugar	50 g
	Butter	175 g
	Egg (M), beaten	3 (150 g)
	Self raising flour	225 g
	Glace cherries, chopped	100 g
	Marzipan, grated	75 g
	Milk	60 mL
	Topping (flaked almonds, roasted)	15 g

- In a large bowl, cream butter and sugar until light and fluffy. Add eggs, one at a time, beating well.
- Add the flour with the cherries and grated marzipan, mix well with the milk to a soft consistency.
- Remove the kneading blade and line the greaseproof paper around the bread pan, then pour in the mixed ingredients.
- Set the bread pan into the main unit, and plug the machine into the socket.
- Carefully sprinkle the toasted almonds on top of the mixture.
- Select the menu and enter 1 hour on the timer.
- After baking test with a skewer to see if the cake is cooked. If the cake does require extra time, select the menu again and enter a further 3 – 5 minutes on the timer. If it is still just slightly sticky, this will cook through during the stand period.
- Take the bread pan out of the machine using oven gloves. Leave to stand for 5 – 10 minutes before removing from the bread pan and allowing to cool.

Bake Only Menu 26 (SD-R2530: 25)



Fruit Cake

Timer: 1 h 20 min

(OZ) / (NZ)

	Butter	150 g
	Sugar	130 g
	Egg (M), beaten	3 (150 g)
	Milk	1 tbsp
	Plain flour (mixed and)	250 g
	Baking powder (sifted)	10 g
	Mixed dried fruits *	70 g

* Cut into approx. 5 mm cubes.

- In a large bowl, cream butter and sugar until light and fluffy. Add eggs, one at a time, beating well.
- Add milk, sifted A and mix dried fruits, beating well after addition.
- Remove the kneading blade and line the greaseproof paper around the bread pan, then pour in the mixed ingredients.
- Set the bread pan into the main unit, and plug the machine into the socket.
- Select the menu and set the baking time: 1 hour and 20 minutes.
- Press  button to start.
- Press  button and remove cake when machine beeps 8 times and the cube () near END flashes.

Jam Menu 27 (SD-R2530: 26)

Strawberry Jam

Timer: 1 h 40 min

(OZ) / (NZ)

	Strawberries, finely chopped	600 g
	Sugar	400 g
	Powdered pectin *	13 g

Apricot Jam

Timer: 1 h 30 min

(OZ) / (NZ)

	Apricots, finely chopped	500 g
	Sugar	250 g
	Powdered pectin *	6 g

* Sprinkle the pectin on the ingredients in the bread pan before setting the bread pan into the main unit.

Compute Menu 28 (SD-R2530: 27)

Apple Sauce

Timer: 1 h 20 min

(OZ) / (NZ)

	Bramley apples, peeled, cored and diced	1000 g
	Water	2 tbsp

- Stir after cooking is completed.

Peach in Vanilla Syrup

Timer: 1 h

(OZ) / (NZ)

	Peaches, stone removed and cut into 1/8	1000 g
	Sugar	100 g
	Vanilla pod	1/2
	Water	125 mL

- When cooking is complete, remove the peaches with a slotted spoon. Carefully pour the syrup over the fruit. Leave to cool.

Recipes

Manual Recipes



Turn to P. 19 for handling instructions.

Cake Kneading Menu 29 (SD-R2530: 28)

Cake Dough

Menu 29 (SD-R2530: 28) Timer: 20 min

(OZ) / (NZ)

Butter (cut into 1 cm cubes)	200 g
Sugar	180 g
Milk	2 tbsp
Egg (M), beaten	4 (200 g)
□ Plain flour (mixed and)	300 g
△ Baking powder (sifted)	13 g

Poppy Seed Gluten Free Cake

Menu 29 (SD-R2530: 28) Timer: 10 min

(OZ) / (NZ)

Vegetable oil	150 g
Egg (M), beaten	3 (150 g)
Milk	110 mL
Sugar	180 g
White rice flour	210 g
Ground almond	75 g
Baking powder	1½ tbsp
Lemon juice	1½ tbsp
Poppy seeds	23 g

- Icing as you like. Mix 15 g of lemon juice with 75 g of icing sugar and sprinkle on the baked gluten-free cake.

Bread Kneading Menu 30 (SD-R2530: 29) & Rise Menu 32 (SD-R2530: 30)

Bread Dough

Stage 1 Bread Kneading: Menu 30 (SD-R2530: 29)

Stage 2 Rise: Menu 31 (SD-R2530: 30)

(Kneading temperature condition : 28 °C)

	(OZ)	(NZ)
Dry yeast (OZ)/SUREBAKE yeast *1 (NZ)	1½ tsp	3½ tsp
Bread flour (OZ) / White flour (NZ)	500 g	500 g
Sugar	1 tbsp	1 tbsp
Salt	1½ tsp	1½ tsp
Eggs (M), beaten	½ (25 g)	½ (25 g)
Water	320 mL	320 mL
Butter	15 g	15 g

Stage 1

1 See step 1 - 4 of Bread Kneading. (P. 19)

(Kneading time setting: 20 minutes)

2 When kneading is complete, put the butter into the bread pan and close the lid.

3 Rest for 5 minutes.

4 Repeat the step 1 - 4 of Bread Kneading. (P. 19)

(Kneading time setting: 12 minutes)

Stage 2

Option 1:

1 Shape the finish dough to your favourite shape and allow it to rise in the oven.

Option 2:

1 See step 1 - 5 of Rise. (P. 19)

*1 If you are a New Zealand customer using instant dry yeast please refer to the OZ recipe.

*2 The milk powder may be omitted.

Rice Flour English Muffin Dough

Stage 1 Bread Kneading: Menu 30 (SD-R2530: 29)

Stage 2 Rise: Menu 31 (SD-R2530: 30)

(Kneading temperature condition : 28 °C)

- Making the English Muffin in 9 cm diameter (10 inches).
(Divided into 10 pieces)

(OZ) / (NZ)

Dry yeast (OZ)/Instant yeast (gluten free yeast) (NZ)	1 tsp
Mixture / beat 1 egg + 1 egg white + warm water	430 g
Butter, melted	60 mL
Cider vinegar	1 tsp
Brown rice flour	300 g
Potato starch	100 g
Powdered milk (OZ) / Milk powder (NZ) *2	50 g
Xanthan gum	1 tbsp
Sugar	1 tbsp
Salt	1 tsp

Topping

Cornmeal	Appropriate amount
----------	--------------------

Stage 1

1 See step 1 - 4 of Bread Kneading. (P. 19)

(Kneading time setting: 5 minutes)

2 After kneading is complete, open the lid, scrape off the flour.

3 Rest for 5 minutes.

4 Repeat the step 1 - 4 of Bread Kneading. (P. 19)

(Kneading time setting: 10 minutes)

Stage 2

1 See step 1 - 5 of Rise. (P. 19)

(Rise time setting: 20 minutes)

2 Put about 90 g of dough into the mold and sprinkle the cornmeal for finishing.

3 Ferment it to 80 % of the size in an oven at 40 °C for about 30 minutes.

4 Sprinkle cornmeal on its surface and cover the mold.

5 Bake in an oven at 180 °C for about 15 minutes.

Cleaning & Care

Before cleaning, unplug the machine and allow it to cool down.

■ To avoid damaging the machine.

- Do not use anything abrasive. (cleansers, scouring pads etc)
- Do not wash any part of the machine in the dishwasher.
- Do not use benzine, thinners, alcohol, or bleach.
- After rinsing the washable parts, wipe with cloth. Always keep all parts clean and dry.

Bread pan & Kneading blade

Remove any leftover dough. Wash with a soft sponge and dry it thoroughly.

- Do not submerge the bread pan in water.
- If difficult to remove the kneading blade, pour warm water into the bread pan and wait 5–10 minutes. (Do not leave it for too long time.) Do not put warm water with soap in the bread pan.

Exterior & Steam vent

- Wipe with a damp cloth.

Dispenser lid

Remove and wash with water. Dry it completely especially the yeast dispenser lid.

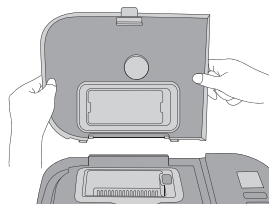

- Raise the dispenser lid to an angle of approximately 75 degrees. Align the connections and pull it in an upward direction to remove or push carefully back at the same angle to attach. Wait until the machine has cooled down first, because it will be very hot immediately after use.
- Take care not to damage or pull the seal. (Damage could lead to leakage of steam, condensation or deformation.)

Interior

Remove the food residues.

Use a damp cloth to wipe inside of machine except heating element and temperature sensor area.

- The colour of the interior may change with use.

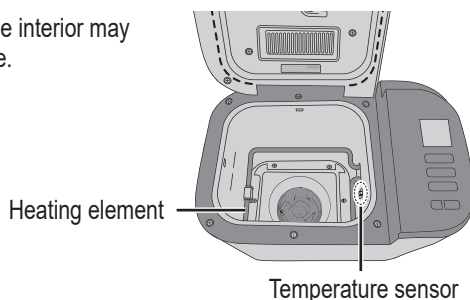

Raisin nut dispenser

Remove and wash with water.

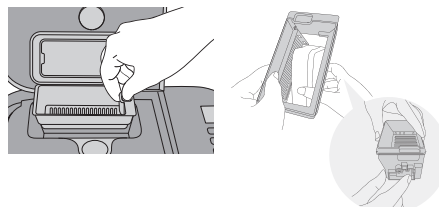

- Wash after each use to remove any residue.

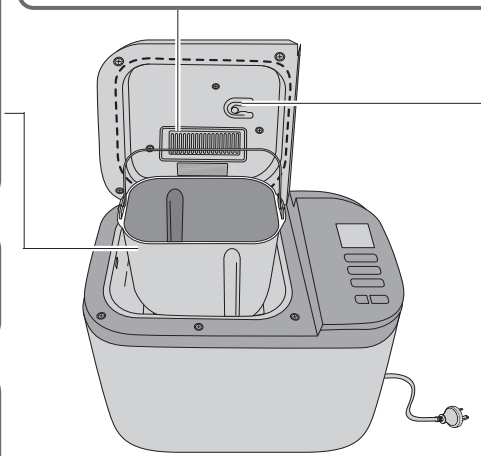

Yeast dispenser (SD-YR2550 only)

Wipe with a damp cloth and dry naturally.

- If wipe with a dry cloth, dry yeast will not drop into the bread pan due to static.

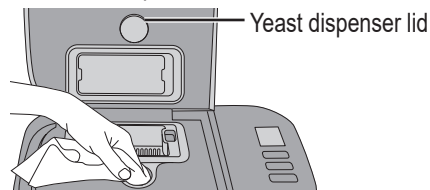

Yeast dispenser lid (SD-YR2550 only)

Wipe with dry cloth when it is wet.

Measuring spoon & Sourdough Starter spoon

Wash with water.

Sourdough cup

Wash with warm soapy water and dry well.

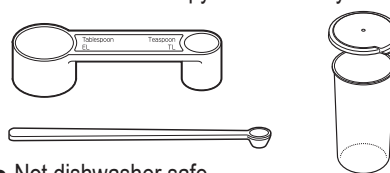

- Not dishwasher safe

Troubleshooting

Before calling for service, please check through this section.

Problem	Cause and Action
During or after cooking	
<p>My bread does not rise well.</p> <p>The top of my bread is uneven.</p>	<p>[All bread]</p> <ul style="list-style-type: none"> ● Your flour gluten quality is poor, or you have not used strong flour. (Gluten quality can vary depending on temperature, humidity, how the flour is stored, and the season of harvest). → Try another type, brand or another batch of flour. ● The dough becomes too firm as you haven't used enough liquid. → Stronger flour with higher protein content absorbs more water than others, try adding an extra 10 - 20 mL. ● You are not using the right type of dry yeast . → Use a dry yeast from a sachet, which has "Easy blend", "Fast Action" or "Easy Bake" written on it. This type does not require pre-fermentation. ● You are not using enough dry yeast, or your dry yeast is old. → Use the measuring spoon provided. Check the dry yeast's expiry date. (Keep dry yeast in refrigerator) ● The dry yeast has touched liquid before kneading. → Check that you have put the ingredients in the correct order according to the instructions. (P. 12) ● You have used too much salt, or not enough sugar. → Check the recipe and measure out the correct amounts using the measuring spoon provided. → Check that salt and sugar are not included in other ingredients.
<p>Can failed dough be used again? E.g: The dough hasn't been baked...etc.</p>	<ul style="list-style-type: none"> ● It can be used to make doughnut, pizza and others. Please confirm at which status baking stopped and resumed the subsequent operations. <ul style="list-style-type: none"> • When there is still dry yeast in the yeast dispenser (SD-YR2550 only). → Re-start making dough using the "Pizza" dough procedure to make doughnut or pizza (P. 13, 28). • When dry yeast had been mixed with other ingredients. → Take out the dough and make doughnut or pizza (P. 13, 28). • When the bread dough is halfway fermented or baked. → Take out the dough and start baking for 40 minutes at 170 °C in the oven. While observing the situation while baking.
<p>My bread has not risen at all.</p> <p>My bread is pale and sticky.</p>	<ul style="list-style-type: none"> ● You did not use dry yeast. → Place the correct amount of dry yeast. ● You are not using enough dry yeast, or your dry yeast is old. → Use the measuring spoon provided. Check the dry yeast's expiry date. (Keep dry yeast in refrigerator.) ● There has been a power failure, or the machine has been stopped during bread making. → You will need to remove the bread from the bread pan and start again with new ingredients.
<p>Dry yeast does not drop into the bread pan. (SD-YR2550 only)</p>	<ul style="list-style-type: none"> ● The timing of yeast dispenser activation is different depending on the menu program and room temperature. ● Yeast dispenser is wet, or there may be a static build up. → Wipe with a damp cloth and dry naturally. ● Dry yeast is damped. → Use new dry yeast.
<p>My bread is sticky and slices unevenly.</p>	<ul style="list-style-type: none"> ● It was too hot when you sliced it. → Allow your bread to cool on rack before slicing to release the steam.
<p>My bread has risen too much.</p>	<ul style="list-style-type: none"> ● You have used too much dry yeast/water. → Check the recipe and measure out the correct amount using the measuring spoon (dry yeast) / sourdough cup (water) provided. → Check that excess water amount is not included in other ingredients. ● You have used too much flour. → Carefully weigh the flour using scales.
<p>My bread is full of air holes.</p>	<ul style="list-style-type: none"> ● You have used too much dry yeast. → Check the recipe and measure out the correct amount using the measuring spoon provided. ● You have used too much liquid. → Some types of flour absorb more water than others, so try using 10 – 20 mL less water.

Problem	Cause and Action
During or after cooking	
My bread seems to have collapsed after rising.	<ul style="list-style-type: none"> ● The quality of your flour isn't very good. → Try using a different brand of flour. ● You have used too much liquid. → Try using 10 – 20 mL less water.
The crust creases and goes soft on cooling.	<ul style="list-style-type: none"> ● The steam remaining in the bread after baking can pass into the crust and soften it slightly. → To reduce the amount of steam, try using 10 – 20 mL less water.
The sides of my bread have collapsed and the bottom is damp.	<ul style="list-style-type: none"> ● You have left the bread in the bread pan for too long after baking. → Remove the bread promptly after baking. ● There has been a power failure, or the machine has been stopped during bread making. → The machine switches off if it is stopped for more than 10 minutes.
How can I keep my crust crispy?	<ul style="list-style-type: none"> ● To make your bread more crispy, you could use the "Dark" crust colour option, or even bake it in the oven at 200 °C for an extra 5 – 10 minutes.
There is excess oil on the bottom of brioche. The crust is oily. My bread has big holes.	<ul style="list-style-type: none"> ● Did you add butter within 5 minutes of the beep? → Do not put butter when display show remaining time until ready. (P. 15) Butter flavour might be weak, but it can bake.
My brioche did not turn out well when using bread mix.	<ul style="list-style-type: none"> ● Try following things. → It might be baked better if dry yeast is decreased a little when using menu 10. (If adding dry yeast separately). → Follow the recipe on the bread mix, but the bread mix should be between 350 – 500 g. → Place the ingredients in the order described in the recipe. When adding the extra ingredients, add them later. (P. 15) → The completion is different according to recipe on the bread mix.
Why has my bread not mixed properly?	<ul style="list-style-type: none"> ● You haven't put the kneading blade in the bread pan. → Make sure the kneading blade is in the bread pan before you put in the ingredients.
Extra ingredients are not mixed properly.	<ul style="list-style-type: none"> ● Did you add extra ingredients to the raisin nut dispenser before the beep or add it into the bread pan while "👏" is flashing? → Extra ingredients must be added to the raisin nut dispenser before the beep or put it into the bread pan during "👏" is flashing on the display.
Extra ingredients are not mixed properly in Brioche.	<ul style="list-style-type: none"> ● Did you add additional ingredients within 5 minutes of the beep? → Extra ingredients must be added while "👏" is flashing in the display. ● Some of the bread mix dough is harder to mixed extra ingredients in or to flick out some of them. → Decrease the extra ingredients into half.
Extra ingredients do not fall into the bread pan from the raisin nut dispenser.	<ul style="list-style-type: none"> ● Is the surface of the extra ingredients higher than the edge of the raisin nut dispenser? → Put the extra ingredients so that its surface is lower than the edge of the raisin nut dispenser. (P. 14) The capacity of the raisin nut dispenser is 150 g, however depending on the state and the type of ingredients, they may overflow.
There is excess flour around the bottom and sides of my bread.	<ul style="list-style-type: none"> ● You have used too much flour, or you are not using enough liquid. → Check the recipe and measure out the correct amount using scales for the flour or the sourdough cup provided for liquids.

Troubleshooting

Before calling for service, please check through this section.

Problem	Cause and Action
During or after cooking	
My bread has not been baked.	<ul style="list-style-type: none"> ● The dough menu was selected. → The dough menu does not include a baking process. ● There has been a power failure, or the machine has been stopped during bread making. → You can try baking the dough in your oven if it has risen and proved. ● There is not enough water and the motor protection device has been activated. This only happens when the machine is overloaded and excessive force is applied to the motor. → Visit place of purchase for a service consultation. Next time, check the recipe and measure out the correct amount using the sourdough cup provided. ● You have forgotten to attach the kneading blade. → Make sure you attach the kneading blade first. (P. 12) ● The kneading mounting shaft in the bread pan is stiff and does not rotate. → If the kneading mounting shaft does not rotate when the kneading blade is attached, you will need to replace the kneading mounting shaft unit. (Consult the place of purchase or a Panasonic service centre.)
The bread does not come out.	<ul style="list-style-type: none"> ● If the bread cannot be easily removed from the bread pan, leave the bread pan for 5 – 10 minutes to cool, making sure that it is not left unattended where somebody or something may get burnt. After that, shake the bread pan several times using oven gloves. (Hold the handle down so that it does not get in the way of bread.)
The kneading blade stays in the bread when I remove it from the bread pan.	<ul style="list-style-type: none"> ● The dough is a little stiff. → Allow the bread to cool completely before removing the kneading blade carefully. Some types of flour absorb more water than others, so try adding an extra 10 – 20 mL of water next time. ● Crust has built up underneath the kneading blade. → Wash the kneading blade and its spindle after each use.
My gluten free pasta did not turn well.	<ul style="list-style-type: none"> ● Your dough was too soft. → Decrease the water volume or increase the amount of xanthan gum. ● Your dough was too hard. → Decrease the amount of xanthan gum or increase the water volume.
When cooking jam, it has scorched or the kneading blade fixes and it doesn't come off.	<ul style="list-style-type: none"> ● The amount of the fruit is too little, or the amount of sugar is too much. → Place the bread pan in the sink and half fill the bread pan with warm water. Leave the bread pan to soak until the cooked on mixture or kneading blade loosens. After scorching is relieved, wash it with a soft sponge etc.
The jam has boiled over.	<ul style="list-style-type: none"> ● Too much fruit or sugar has been used. → Only use the amounts of fruit and sugar specified in the recipes on P. 29.
Jam is too runny and not firmly set.	<ul style="list-style-type: none"> ● The fruit was under or over ripe. ● Sugar was decreased too much. ● Cooking time was insufficient. ● Fruit with a low pectin content was used. → Leave the jam to cool completely. The jam will continue to set as it cools. → Use the runny jam as a sauce for desserts.
What kinds of sugar can we use on jam?	<ul style="list-style-type: none"> ● White caster and granulated can be used. Do not use brown sugar, diet sugar, and low calorie sugar or artificial sweetener.
Can frozen fruits be used?	<ul style="list-style-type: none"> ● It can be used for only jam and compote.

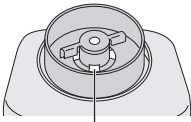
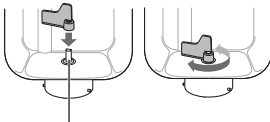
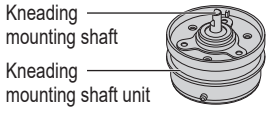
Problem	Cause and Action
During or after cooking	
When making jam, can we use fruits are pickled in alcohol?	<ul style="list-style-type: none"> Do not use them. The quality is not satisfactory.
The fruit has collapsed when making compote.	<ul style="list-style-type: none"> The cooking time was too long. The fruit may have been over ripe.
Puzzle	
The kneading blade rattles.	<ul style="list-style-type: none"> This is because the kneading blade fits loosely on the kneading mounting shaft. (This is not a fault.)
I can smell burning while the bread is baking. <hr/> Smoke is coming out of the steam vent.	<ul style="list-style-type: none"> Ingredients may have been spilt on the heating element. <ul style="list-style-type: none"> → Sometimes a little flour, raisins or other ingredients may be flicked out of the bread pan during mixing. Simply wipe the heating element gently after baking once the machine has cooled down. → Remove the bread pan from the main unit to place ingredients.
Dough leaks out from bottom of the bread pan.	<ul style="list-style-type: none"> A small amount of dough will escape through the ventilation holes (so that it does not stop the rotating parts from rotating). This is not a fault, but check occasionally that the kneading mounting shaft rotate properly. <ul style="list-style-type: none"> → If the kneading mounting shaft does not rotate when the kneading blade is attached, you will need to replace the kneading mounting shaft unit. (Consult the place of purchase or Panasonic service centre.) <div style="display: flex; align-items: center; justify-content: center;"> <div style="text-align: center; margin-right: 10px;">  <p>Ventilation holes (4 in total)</p> </div> <div style="text-align: center; margin-right: 10px;">  <p>Kneading mounting shaft</p> </div> <div style="text-align: center;">  <p>Kneading mounting shaft Kneading mounting shaft unit Part no. ADA29E226</p> </div> </div>
Display exception	
"1" appears on the display and operation has been stopped.	<ul style="list-style-type: none"> When the power supply to machine is interrupted for a certain time, the display shows "1" after recovered. (It is standby mode and machine could not continue the program.) <ul style="list-style-type: none"> → Remove the bread, dough or ingredients and start again using new ingredients.
"H01", "H02" appears on the display.	<ul style="list-style-type: none"> The display indicates a problem with the machine. <ul style="list-style-type: none"> → Consult the place of purchase or a Panasonic service centre.
"U50" appears on the display.	<ul style="list-style-type: none"> The machine is hot (above 40 °C). This may occur with repeated use. <ul style="list-style-type: none"> → Allow the machine to cool down to below 40 °C before using it again (U50 will disappear).

Panasonic Warranty

Home Appliance 12 Month Warranty from Date of Purchase

1. Subject to the conditions of this warranty Panasonic or its Authorised Service Centre will perform necessary service on the product without charge for parts or labour, if in the opinion of Panasonic, the product is found to be faulty within the warranty period. For Communications products (i.e. Cordless Phones, etc) the genuine battery(s) has a 3 month warranty.
2. This warranty only applies to Panasonic products purchased in Australia and sold by Panasonic Australia or its Authorised Distributors or Dealers and only where the products are used and serviced within Australia or it's territories. Warranty cover only applies to service carried out by a Panasonic Authorised Service Centre and only if valid proof of purchase is presented when warranty service is requested.
3. This warranty only applies if the product has been installed and used in accordance with the manufacturer's recommendations (as noted in the operating instructions) under normal use and reasonable care (in the opinion of Panasonic). The warranty covers normal domestic use only (also Clip & Trim Professional use) and does not cover damage, malfunction or failure resulting from use of incorrect voltages, incorrect installation, accident, misuse, neglect, build-up of dirt or dust, abuse, maladjustment of customer controls, mains supply problems, thunderstorm activity, infestation by insects or vermin, tampering or repair by unauthorised persons (including unauthorised alterations), exposure to abnormally corrosive conditions or any foreign object or matter having entered the product.
4. This warranty does not cover the following items unless the fault or defect existed at the time of purchase:
 - (a) Cabinet Parts
 - (b) Microwave Oven Plates.
 - (c) User replaceable Batteries
 - (d) Kneader Mounting Shaft, Shaver Heads, Cutters, Foils, Blades
 - (e) Accessories
 - (f) Noise or vibration that is considered normal
5. To claim warranty service, when required, you should:
 - Contact Panasonic's Customer Care Centre on 132600
 - Send or take the product to a Panasonic Authorised Service Centre together with your purchase receipt as a proof of purchase date. Please note that freight and insurance to and / or from your nearest Authorised Service Centre must be arranged by you.
6. The warranties hereby conferred do not extend to, and exclude, any costs associated with the installation, de-installation or re-installation of a product, including costs related to the mounting, de-mounting or remounting of any screen, (and any other ancillary activities), delivery, handling, freighting, transportation or insurance of the product or any part thereof or replacement of and do not extend to, and exclude, any damage or loss occurring by reason of, during, associated with, or related to such installation, de-installation, re-installation or transit.

Panasonic Authorised Service Centres are located in major metropolitan areas and most regional centres of Australia, however, coverage will vary dependant on product. For advice on exact Authorised Service Centre locations for your product, please telephone our Customer Care Centre on 132600.

In addition to your rights under this warranty, Panasonic products come with consumer guarantees that cannot be excluded under the Australian Consumer Law. If there is a major failure with the product, you can reject the product and elect to have a refund or to have the product replaced or if you wish you may elect to keep the goods and be compensated for the drop in value of the goods. You are also entitled to have the product repaired or replaced if the product fails to be of acceptable quality and the failure does not amount to a major failure.

If there is a major failure in regard to the product which cannot be remedied then you must notify us within a reasonable period by contacting the Panasonic Customer Care Centre. If the failure in the product is not a major failure then Panasonic may choose to repair or replace the product and will do so in a reasonable period of time from receiving notice from you.

**THIS WARRANTY CARD AND THE PURCHASE DOCKET (OR SIMILAR PROOF OF PURCHASE)
SHOULD BE RETAINED BY THE CUSTOMER AT ALL TIMES**

If you require assistance regarding warranty conditions or any other enquiries, please visit the **Panasonic Australia** website www.panasonic.com.au or contact by phone on **132 600**
If phoning in, please ensure you have your operating instructions available.

Panasonic Australia Pty. Limited

ACN 001 592 187 ABN 83 001 592 187

1 Innovation Road, Macquarie Park NSW 2113
www.panasonic.com.au

PRO-031-F01 Issue: 6.0

02-10-2013

Panasonic Warranty

Built In Kitchen Appliance 24 Month from Date of Purchase Home Appliance 24 Month Warranty from Date of Purchase

1. Subject to the conditions of this warranty Panasonic or its Authorised Service Centre will perform necessary service on the product without charge for parts or labour, if in the opinion of Panasonic, the product is found to be faulty within the warranty period. For Line Communications products (i.e. Cordless Phones, etc.) the genuine battery(s) has a 3 month warranty.
2. This warranty only applies to Panasonic products purchased in New Zealand and sold by Panasonic New Zealand or its authorised Distributors or Dealers and only where the products are used and serviced within New Zealand or its territories. Warranty cover only applies to service carried out by a Panasonic Authorised Service and only if valid proof of purchase is presented when warranty service is requested.
3. This warranty only applies if the product has been installed and used in accordance with the manufacturer's recommendations (as noted in the operating instructions) under normal use and reasonable care (in the opinion of Panasonic). The warranty covers normal domestic use only (also Clip & Trim Professional use) and does not cover damage, malfunction or failure resulting from use of incorrect voltages, incorrect installation, accident, misuse, neglect, build-up of dirt or dust, abuse, maladjustment of customer controls, mains supply problems, thunderstorm activity, infestation by insects or vermin, tampering or repair by unauthorised persons (including unauthorised alterations), exposure to abnormally corrosive conditions or any foreign object or matter having entered the product.
4. This warranty does not cover the following items unless the fault or defect existed at the time of purchase:
 - (a) Cabinet Parts
 - (b) Microwave Oven cook plates
 - (c) User replaceable Batteries from wear and tear in normal use
 - (d) Kneader mounting shaft unit and Heads, Cutters, Foils, Blades and other accessories
 - (e) Noise or vibration that is considered normal
 - (f) Correcting the installation (e.g. removal of transit bolts, levelling and locking feet)
 - (g) Damage caused by water pressure exceeding 1MPa
 - (h) Water on floor due to incorrect loading, excessive suds, foreign matter on door seals
 - (i) Blocked pumps and removal filters, removal of foreign objects from the machine (e.g. bra wires, bread tags, nails, screws, coins, grit etc.)
 - (j) Replaceable lint filters
 - (k) Damage to surfaces caused by liquid or solid spillages, impact or lack of maintenance & cleaning products other than that recommended in the operating instructions
 - (l) Consumables (light bulbs, filters)
5. To claim warranty service, when required, you should:
 - Telephone Panasonic's Customer Care Centre on 09 272 0178 or visit our website referred to below and use the Service Centre Locator for the name/address of the nearest Authorised Service Centre.
 - Send or take the product to a Panasonic Authorised Service Centre together with your proof of purchase receipt as a proof of purchase date. Please note that freight and insurance to and / or from your nearest Authorised Service Centre must be arranged by you.
6. The warranties hereby conferred do not extend to, and exclude, any costs associated with the installation, de-installation or re-installation of a product, including costs related to the mounting, de-mounting or remounting of any screen, (and any other ancillary activities), delivery, handling, freighting, transportation, or insurance of the product or any part thereof or replacement of and do not extend to, and exclude, any damage or loss occurring by any reason of, during, associated with, or related to such installation, de-installation, re-installation or transit.

Panasonic Authorised Service Centres are located in major metropolitan areas and most regional centres of New Zealand, however, coverage will vary dependant on product. For advice on exact Authorised Service Centre locations for your product, please telephone our customer Care Centre on 09 272 0178 or visit our website and use the Service Centre locator.

Unless otherwise specified to the consumer the benefits conferred by this express warranty are additional to all other conditions, warranties, guarantees, rights and remedies expressed or implied by the Consumer Guarantees Act of New Zealand and all other obligations and liabilities on the part of the manufacturer or supplier and nothing contained herein shall restrict or modify such rights, remedies, obligations and liabilities.

**THIS WARRANTY CARD AND THE PURCHASE DOCKET (OR SIMILAR PROOF OF PURCHASE)
SHOULD BE RETAINED BY THE CUSTOMER AT ALL TIMES**

If you require assistance regarding warranty conditions or any other enquiries, please visit the **Panasonic New Zealand** website www.panasonic.co.nz or contact by phone on **09 272 0178**
If phoning in, please ensure you have your operating instructions available.

PANASONIC NEW ZEALAND CUSTOMER CARE CENTRE

Phone: 09 272 0178

Fax: 09 272 0129

Email: customerservice@nz.panasonic.com

Website: www.panasonic.co.nz/support

Specifications

	SD-YR2550	SD-R2530	
Power supply	230 V-240 V ~ 50 Hz		
Power consumption	505 W-550 W		
Capacity	Strong bread flour	max. 620 g	min. 250 g
	Yeast (Dry yeast)	max. 8.4 g	min. 2.1 g
	(SUREBAKE yeast)	max. 9.8 g	min. 2.8 g
	Baking powder	max. 13 g	min. 10 g
Capacity of raisin nut dispenser	Max. 150 g dried fruits / nuts		
Timer	Digital timer (up to 13 hours)		
Dimensions (W × H × D)	Approx. 40.8 × 36.2 × 25.2 cm		
Weight	Approx. 7.5 kg	Approx. 7.0 kg	
Accessories	1 sourdough cup, 1 measuring spoon, 1 sourdough starter spoon		

Memo

Panasonic Taiwan Co., Ltd.
<https://www.panasonic.com>
© Panasonic Taiwan Co., Ltd. 2021



DZ50R2261
MX0621L10222
Printed in China