

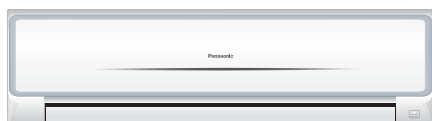

Panasonic[®]

Operating Instructions Air Conditioner



Model No.

Indoor Unit

**CS-PC18UKY series
CS-PC18UKY-1 series**

Outdoor Unit

**CU-PC18UKY series
CU-PC18UKY-1 series**



**Operating Instructions
Air Conditioner**

Thank you for purchasing Panasonic Air Conditioner.
Installation instructions attached.
Before operating the unit, read these operating
instructions thoroughly and keep them for future
reference.

English

ACXF55-20860-AB

Quick guide

Inserting the batteries

- ① Pull out the back cover of remote control
- ② Insert AAA or R03 batteries
(can be used ~ 1 year)
- ③ Close the cover

Basic operation

- ① Start/stop the operation



• Please note that the OFF indication is as follows:

To start:  OFF

To stop:  OFF

- ② Select the desired temperature

• Selection range:

16 °C ~ 30 °C.

• Operating the unit within the recommended temperature may save energy:

26 °C ~ 28 °C.

• Use remote control within 8 m from the remote control receiver of the indoor unit.

The illustrations in this manual are for explanation purposes only and may differ from the actual unit. They are subject to change without notice for future improvement.

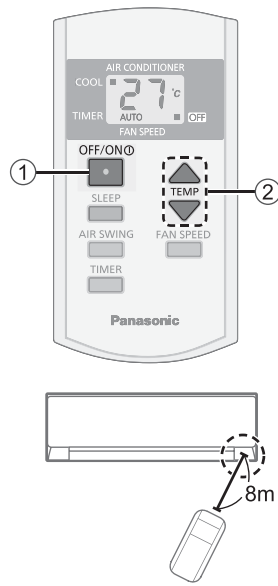
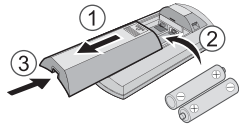

English

Table of contents

Safety precautions..... 4-5
 How to use..... 6-7
 Cleaning instructions 8
 Troubleshooting 9
 Information.....10



Accessories

- Remote control
- AAA or R03 batteries × 2



English

Safety precautions

To prevent personal injury, injury to others or property damage, please comply with the following: Incorrect operation due to failure to follow instructions below may cause harm or damage, the seriousness of which is classified as below:

	WARNING	This sign warns of death or serious injury.
	CAUTION	This sign warns of injury or damage to property.

The instructions to be followed are classified by the following symbols:

	This symbol denotes an action that is PROHIBITED .
	These symbols denote actions COMPULSORY .

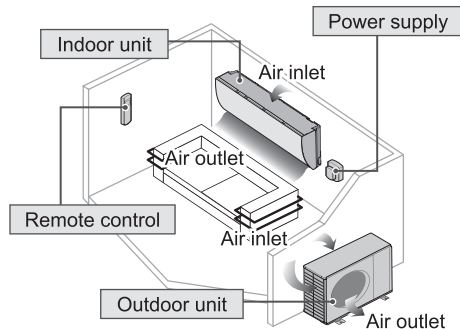

WARNING

Indoor unit and outdoor unit



This appliance is not intended for use by persons (including children) with reduced physical, sensory or mental capabilities, or lack of experience and knowledge, unless they have been given supervision or instruction concerning use of the appliance by a person responsible for their safety. Children should be supervised to ensure that they do not play with the appliance.

Please consult authorised dealer or specialist to clean the internal parts, repair, install, remove and reinstall the unit. Improper installation and handling will cause leakage, electric shock or fire.

Confirm with authorised dealer or specialist on usage of any specified refrigerant type. Using refrigerant type other than the specified may cause product damage, burst and injury etc.



Do not install the unit in a potentially explosive or flammable atmosphere. Failure to do so could result in fire.

Do not insert your fingers or other objects into the air conditioner indoor or outdoor unit, rotating parts may cause injury.



Do not touch the outdoor unit during lightning, it may cause electric shock.

Do not expose yourself directly to cold air for a long period to avoid excess cooling.

Do not sit or step on the unit, you may fall down accidentally.



Remote control



Do not allow infants and small children to play with the remote control to prevent them from accidentally swallowing the batteries.

Power supply



Do not use a modified cord, joint cord, extension cord or unspecified cord to prevent overheating and fire.



To prevent overheating, fire or electric shock:

- Do not share the same power outlet with other equipment.
- Do not operate with wet hands.
- Do not over bend the power supply cord.
- Do not operate or stop the unit by inserting or pulling out the power plug.



Use complete power supply cord without joining. In unavoidable circumstances that complete power supply cord without joining is impossible, use an approved connection means (for example: socket and plug).

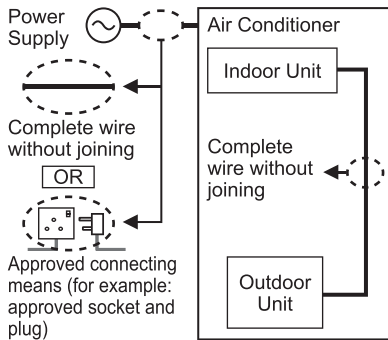

If the supply cord is damaged, it must be replaced by the manufacturer, service agent or similarly qualified persons in order to avoid a hazard.

It is strongly recommended to be installed with Earth Leakage Circuit Breaker (ELCB) or Residual Current Device (RCD) to prevent electric shock or fire.

To prevent overheating, fire or electric shock:

- Insert the power plug properly.
- Dust on the power plug should be periodically wiped with a dry cloth.

Stop using the product if any abnormality/failure occurs and disconnect the power plug or turn off the power switch and breaker.

(Risk of smoke/fire/electric shock) Examples of abnormality/failure

- The ELCB trips frequently.
- Burning smell is observed.
- Abnormal noise or vibration of the unit is observed.
- Water leaks from the indoor unit.
- Power cord or plug becomes abnormally hot.
- Fan speed cannot be controlled.
- The unit stops running immediately even if it is switched on for operation.
- The fan does not stop even if the operation is stopped.

Contact your local dealer immediately for maintenance/repair.



This equipment must be earthed to prevent electrical shock or fire.



Prevent electric shock by switching off the power supply and unplug:



- Before cleaning or servicing,
- When extended non-use, or
- During abnormally strong lightning activity.



CAUTION

Indoor unit and outdoor unit



Do not wash the indoor unit with water, benzene, thinner or scouring powder to avoid damage or corrosion at the unit.

Do not use for preservation of precise equipment, food, animals, plants, artwork or other objects. This may cause quality deterioration, etc.

Do not use any combustible equipment in front of the airflow outlet to avoid fire propagation.

Do not expose plants or pet directly to airflow to avoid injury, etc.

Do not touch the sharp aluminium fin, sharp parts may cause injury.



Do not switch ON the indoor unit when waxing the floor. After waxing, aerate the room properly before operating the unit.

Do not install the unit in oily and smoky areas to prevent damage to the unit.

Do not dismantle the unit for cleaning purpose to avoid injury.

Do not step onto an unstable bench when cleaning the unit to avoid injury.

Do not place a vase or water container on the unit. Water may enter the unit and degrade the insulation. This may cause an electric shock.

Do not open window or door for long time during operation.



Prevent water leakage by ensuring drainage pipe is:

- Connected properly,
- Kept clear of gutters and containers, or
- Not immersed in water

After a long period of use or use with any combustible equipment, aerate the room regularly.

After a long period of use, make sure the installation rack does not deteriorate to prevent the unit from falling down.

Remote control



Do not use rechargeable (Ni-Cd) batteries. It may damage the remote control.



To prevent malfunction or damage of the remote control:

- Remove the batteries if the unit is not going to be used for a long period of time.
- New batteries of the same type must be inserted following the polarity stated.

Power supply



Do not disconnect the plug by pulling the cord to prevent electric shock.

How to use

SLEEP To maximise comfort while sleeping

- This operation provides you with a comfortable environment while sleeping by gradually increase the set temperature 1 °C after 3 hours operation.
- The unit is turned off after 8 hours.
- Can be cancelled by pressing the respective button again.

AIR SWING To adjust vertical airflow direction

(Not shown on remote control display)



- Keeps the room ventilated.
- If AUTO is set, the louver swings up/down automatically.
- Do not adjust the louver by hand.



Remote control receiver and indicator

 **POWER/SLEEP (Green/Orange)**

Remote control display



To adjust horizontal airflow direction

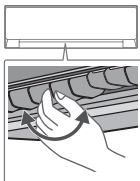

- Manually adjustable.

Auto OFF/ON button



Use when remote control is misplaced or a malfunction occurs.

- To use in COOL mode, press and hold the button until 1 beep is heard, then release.
- Press the button again to turn off.



FAN SPEED
 To select fan speed

(Remote control display)

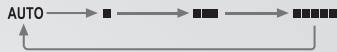

To set the timer

- To turn ON the unit at a preset time, set the timer while the unit is OFF.
- To turn OFF the unit at a delayed time, set the timer while the unit is ON.

Press twice → Press repeatedly to set your desired time

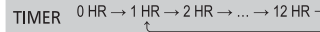

- Once the timer is set, the TIMER indication on the remote control display will be shown.
- To check the remaining time before the timer takes effect, press .
- To cancel the timer, press once, then press again and hold for approximately 3 seconds.
- The timer will also be cancelled when you press or when power failure occurs.
- This setting is for one time operation, you will need to set again each time you want to use the timer.

Auto Restart Control

- If power is resumed after a power failure, the operation will restart automatically after a period of time with previous operation mode and airflow direction.
- This control is not applicable when TIMER is set.

Note: Unit is charged with extra 60g refrigerant for installation purging purpose. For all laboratory tests, 60g shall be released to follow the rated refrigerant amount mentioned in nameplate.

Operation conditions

Use this air conditioner under the following temperature range.

DBT : Dry bulb temperature

WBT : Wet bulb temperature

Temperature (°C)		Indoor		Outdoor	
		DBT	WBT	DBT	WBT
COOL	Max.	35	24	46	27
	Min.	16	11	16	11

Cleaning instructions

To ensure optimal performance of the unit, cleaning has to be carried out at regular intervals. Please consult authorised dealer.

- Switch off the power supply and unplug before cleaning.
- Do not touch the aluminium fin, sharp parts may cause injury.
- Do not use benzine, thinner or scouring powder.
- Use only soap (\approx pH 7) or neutral household detergent.
- Do not use water hotter than 40 °C.

Indoor unit

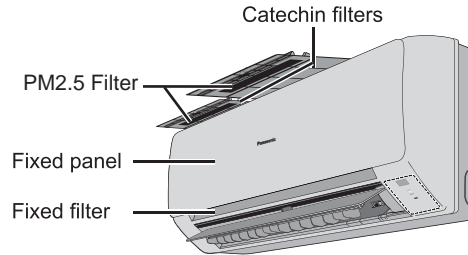

Indoor unit

Wipe the unit gently with a soft, dry cloth.



Fixed panel

- Could not be removed.

Fixed filter

- Could not be removed.
- Wipe the filter gently with a soft damp cloth.

Catechin filters

Every 2 weeks

- Wash/rinse the filters gently with water to avoid damage to the filter surface.
- Dry the filters thoroughly under shade, away from fire or direct sunlight.
- Replace any damaged filters.

* Please remove the PM2.5 Filter before wash/rinse the filter with water.



Remove catechin filter Attach catechin filter

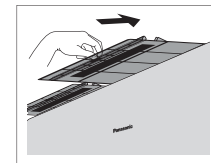
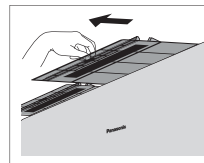

PM 2.5 filter

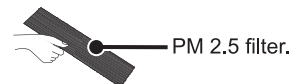

- Clean the filter whenever necessary.
- Don't wash/rinse the filter with water.
- The surface of the filter shouldn't be rubbed with any object.
- The filter shouldn't be pulled with strong force as it may get damaged.

For seasonal inspection after extended non-use

- Checking of remote control batteries.
- No obstruction at air inlet and air outlet vents.
- After 15 minutes of operation, it is normal to have the following temperature difference between air inlet and air outlet vents:

COOL: ≥ 8 °C

For extended non-use

- Turn off the power supply and unplug.
- Remove the remote control batteries.

Troubleshooting

The following symptoms do not indicate malfunction.

Symptom	Cause
Mist emerges from indoor unit.	• Condensation effect due to cooling process.
Water flowing sound during operation.	• Refrigerant flow inside the unit.
The room has a peculiar odour.	• This may be due to damp smell emitted by the wall, carpet, furniture or clothing.
Indoor fan stops occasionally during automatic fan speed setting.	• This helps to remove the surrounding odour.
Operation is delayed a few minutes after restarting.	• The delay is a protection to the unit's compressor.
Outdoor unit emits water/steam.	• Condensation or evaporation occurs on pipes.
Cracking sound during operation.	• Changes of temperature caused the expansion/contraction of the unit.
Discoloration of some plastic parts.	• Discoloration is subject to material types used in plastic parts, accelerated when exposed to heat, sun light, UV light, or environmental factor.

Check the following before calling for servicing.

Symptom	Check
Operation is not working efficiently.	<ul style="list-style-type: none"> • Set the temperature correctly. • Close all doors and windows. • Clean or replace the filters. • Clear any obstruction at the air inlet and air outlet vents.
Noisy during operation.	<ul style="list-style-type: none"> • Check if the unit has been installed at an incline. • Insert the air filter properly.
Remote control does not work. (Display is dim or transmission signal is weak.)	<ul style="list-style-type: none"> • Insert the batteries correctly. • Replace weak batteries.
The unit does not work.	<ul style="list-style-type: none"> • Check if the circuit breaker is tripped. • Check if timers have been set.
The unit does not receive the signal from the remote control.	<ul style="list-style-type: none"> • Make sure the receiver is not obstructed. • Certain fluorescent lights may interfere with signal transmitter. Please consult authorised dealer.

NON SERVICEABLE CRITERIAS

TURN OFF POWER SUPPLY AND UNPLUG then please consult authorised dealer under the following conditions:

- Abnormal noise during operation.
- Water/foreign particles have entered the remote control.
- Water leaks from Indoor unit.
- Circuit breaker switches off frequently.
- Power cord becomes unnaturally warm.
- Switches or buttons are not functioning properly.
- The unit stops and the POWER/SLEEP indicator blinks (insufficient refrigerant detected).

Information

English

Information on hazardous constituents as specified in sub-rule 1 of rule 16 (1) in electrical and electronic equipment.
 Declaration of Conformity with the requirements of the E-Waste (Management) Amendment Rules 2018 with the rule 16 (1) limits with respect to Lead, Mercury, Cadmium, Hexavalent chromium, Polybrominated biphenyls, Polybrominated diphenyl ethers.

The content of hazardous substance with the exemption of the applications listed in SCHEDULE II of the E-Waste (Management) Amendment Rules 2018 :

1. Lead (Pb) – not over 0.1% by weight;
2. Cadmium (Cd) – not over 0.01% by weight;
3. Mercury (Hg) – not over 0.1% by weight;
4. Hexavalent chromium (Cr6+) – not over 0.1% by weight;
5. Polybrominated biphenyls (PBBs) – not over 0.1% by weight;
6. Polybrominated diphenyl ethers (PBDEs) – not over 0.1% by weight.

 For the purpose of recycling to facilitate effective utilization of resources, please return this product to a nearby authorized collection center, registered dismantler of recycler, or Panasonic service center when disposing of this product.

Customer care number (Toll free) : 1800 103 1333 ,1800 108 1333

Please see the Panasonic website for further information on collection centers, etc.
 or call the customer care toll-free number
<http://www.panasonic.com/in/corporate/sustainability/panasonic-india-i-recycle-program.html>

Do's & Don't: E-waste (Management) Amendment Rules 2018

S.No.	Do's	Don't
1.	All electrical and electronic products are required to be handed over only to the Authorized recycler.	The product should not be opened by the User himself / herself, but only by authorized service personnel.
2.	The product should be handed over only to authorized recycler for disposal.	The product is not meant for re-sale to any unauthorized agencies / scrap dealer / kabari-walas.
3.	Keep the product in isolated area, after it becomes non-functional / un-repairable so as to prevent its accidental breakage.	The product is not meant for mixing into household waste stream.
4.	Provide information on the catalogue with product end-of-life.	Do not keep any replaced spare part(s) from the product in exposed area.
5.	Always dispose products that have reached end-of life at Panasonic India Authorized Service Centre.	Do not donate old electronic items to any body. Do not dispose your product in garbage bins along with municipal waste that ultimately reaches landfill.
6.	Wherever possible or as instructed, separate the packaging material according to responsible waste disposal options and sorting for recycling.	Do not give e-waste to informal and unorganized sectors like Local Scrap Dealer / Rag Pickers.



Memo



Information / Memo



English





Panasonic Corporation
Website: <http://www.panasonic.com>

© Panasonic Corporation 2018
Printed in India

ACXF55-20860-AB
FT0318-0

