

Panasonic®

Operating Instructions Air Conditioner



Model No.

Indoor Unit

CS-TU12VKYF series
CS-TU18VKYF series
CS-KU12VKYF series
CS-KU15VKYF series
CS-KU18VKYF series
CS-KU18VKYTF series
CS-KU18VKYLF series
CS-KU24VKYF series

Outdoor Unit

CU-TU12VKYF series
CU-TU18VKYF series
CU-KU12VKYF series
CU-KU15VKYF series
CU-KU18VKYF series
CU-KU18VKYTF series
CU-KU18VKYLF series
CU-KU24VKYF series



**Operating Instructions
Air Conditioner**

Thank you for purchasing Panasonic Air Conditioner.
Installation instructions attached.
Before operating the unit, please read these operating instructions thoroughly and keep them for future reference.

English

Quick guide

Inserting the batteries

- ① Pull out the back cover of remote control
 - ② Insert AAA or R03 batteries
 - ③ Close the cover
-

Clock setting

- ① Press **CLOCK**
 - ② Set the time
 - ③ To confirm Press **SET** or **CLOCK** again
-

Basic operation

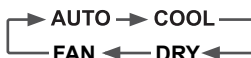
- ① Select the desired mode

- ② Start/stop the operation

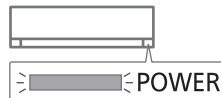

• Please note that the OFF indication is as follows:

To start: 

To stop: 

- ③ Select the desired temperature

- Selection range:
16 °C ~ 30 °C.
- Operating the unit at 25 °C or higher degrees may save energy.
- Better comfort condition at 25 °C or higher degrees.

• Use remote control within 8 m from the remote control receiver of the indoor unit.

The illustrations in this manual are for explanation purposes only and may differ from the actual unit. They are subject to change without notice for future improvement.

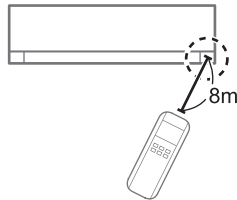
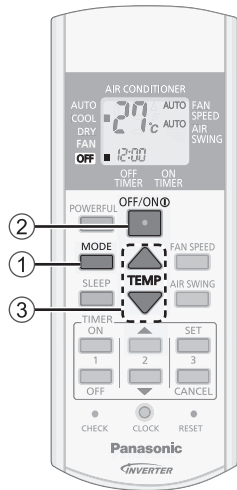
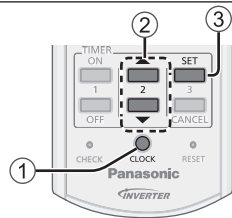
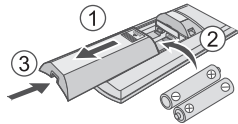

Table of contents

Safety precautions.....	4-9
How to use.....	10-11
Cleaning instructions	12
Troubleshooting.....	13
BEE Regulation.....	14
Information.....	15

Accessories

- Remote control
- AAA or R03 batteries × 2
- Remote control holder
- Screws for remote control holder × 2

Safety precautions

To prevent personal injury, injury to others or property damage, please comply with the following:
 Incorrect operation due to failure to follow instructions below may cause harm or damage, the seriousness of which is classified as below:





	This appliance is filled with R32 (mild flammable refrigerant). If the refrigerant is leaked and exposed to an external ignition source, there is a risk of fire.
---	---

	WARNING This sign warns of death or serious injury.
---	--

	CAUTION This sign warns of injury or damage to property.
---	---

The instructions to be followed are classified by the following symbols:

	This symbol denotes an action that is PROHIBITED .
---	---

 	These symbols denote actions COMPULSORY .
 	

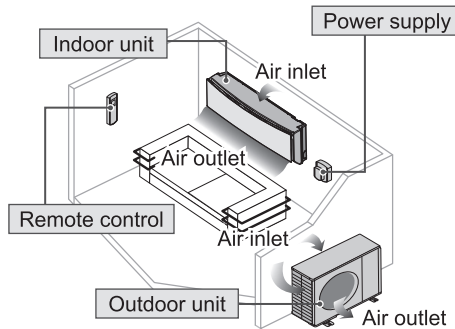

WARNING

Indoor unit and outdoor unit

 This appliance is not intended for use by persons (including children) with reduced physical, sensory or mental capabilities, or lack of experience and knowledge, unless they have been given supervision or instruction concerning use of the appliance by a person responsible for their safety. Children should be supervised to ensure that they do not play with the appliance.

The appliance shall be installed, and/or operated in a room with floor area larger than A_{min} (m²) and keep away from ignition sources, such as heat/sparks/open flame or hazardous areas such as gas appliances, gas cooking, reticulated gas supply systems or electric cooking appliances, etc. (Refer to Table A of Installation instructions table for A_{min} (m²))

Be aware that refrigerant may not contain an odour, highly recommended to ensure suitable flammable refrigerant gas detectors are present, operating and able to warn of a leak.

Please consult authorised dealer or specialist to clean the internal parts, repair, install, remove and reinstall the unit. Improper installation and handling will cause leakage, electric shock or fire. Confirm with authorised dealer or specialist on usage of any specified refrigerant type. Using refrigerant type other than the specified may cause product damage, burst and injury etc.

 Do not use means to accelerate the defrosting process or to clean, other than those recommended by manufacturer. Any unfit method or using incompatible material may cause product damage, burst and serious injury. Do not pierce or burn as the appliance is pressurized. Do not expose the appliance to heat, flame, sparks, or other sources of ignition. Else it may explode and cause injury or death. Do not install the unit in a potentially explosive or flammable atmosphere. Failure to do so could result in fire.

Do not insert your fingers or other objects into the air conditioner indoor or outdoor unit, rotating parts may cause injury. 

Do not touch the outdoor unit during lightning, it may cause electric shock.



Do not expose yourself directly to cold air for a long period to avoid excess cooling.

Do not sit or step on the unit, you may fall down accidentally. 

Remote control

 Do not allow infants and small children to play with the remote control to prevent them from accidentally swallowing the batteries.

Power supply

 Do not use a modified cord, joint cord, extension cord or unspecified cord to prevent overheating and fire.  

To prevent overheating, fire or electric shock:

- Do not share the same power outlet with other equipment.
- Do not operate with wet hands.
- Do not over bend the power supply cord.
- Do not operate or stop the unit by inserting or pulling out the power plug.

 If the supply cord is damaged, it must be replaced by the manufacturer, service agent or similarly qualified persons in order to avoid a hazard.

It is strongly recommended to be installed with Earth Leakage Circuit Breaker (ELCB) or Residual Current Device (RCD) to prevent electric shock or fire.

To prevent overheating, fire or electric shock:

- Insert the power plug properly.
- Dust on the power plug should be periodically wiped with a dry cloth.

Stop using the product if any abnormality/failure occurs and disconnect the power plug or turn off the power switch and breaker.

(Risk of smoke/fire/electric shock) Examples of abnormality/failure

- The ELCB trips frequently.
- Burning smell is observed.
- Abnormal noise or vibration of the unit is observed.
- Water leaks from the indoor unit.
- Power cord or plug becomes abnormally hot.
- Fan speed cannot be controlled.
- The unit stops running immediately even if it is switched on for operation.
- The fan does not stop even if the operation is stopped.

Contact your local dealer immediately for maintenance/repair.

 This equipment must be earthed to prevent electrical shock or fire.

 Prevent electric shock by switching off the power supply and unplug:

- Before cleaning or servicing,
- When extended non-use, or
- During abnormally strong lightning activity.

Precaution for using R32 refrigerant

The basic installation work procedures are the same as conventional refrigerant (R410A, R22) models.

 Since the working pressure is higher than that of refrigerant R22 models, some of the piping and installation and service tools are special.

Especially, when replacing a refrigerant R22 model with a new refrigerant R32 model, always replace the conventional piping and flare nuts with the R32 and R410A piping and flare nuts on the outdoor unit side.

For R32 and R410A, the same flare nut on the outdoor unit side and pipe can be used.

Models that use refrigerant R32 and R410A have a different charging port thread diameter to prevent erroneous charging with refrigerant R22 and for safety.

Therefore, check beforehand. [The charging port thread diameter for R32 and R410A is 1/2 inch.]

Be more careful than R22 so that foreign matter (oil, water, etc.) does not enter the piping.

Also, when storing the piping, securely seal the opening by pinching, taping, etc. (Handling of R32 is similar to R410A.)



CAUTION

Indoor unit and outdoor unit

 Do not wash the indoor unit with water, benzene, thinner or scouring powder to avoid damage or corrosion at the unit.

Do not use for preservation of precise equipment, food, animals, plants, artwork or other objects. This may cause quality deterioration, etc.

Do not use any combustible equipment in front of the airflow outlet to avoid fire propagation.

Do not expose plants or pet directly to airflow to avoid injury, etc.

Do not touch the sharp aluminium fin, sharp parts may cause injury. 

Do not switch ON the indoor unit when waxing the floor. After waxing, aerate the room properly before operating the unit.

Do not install the unit in oily and smoky areas to prevent damage to the unit.

Do not dismantle the unit for cleaning purpose to avoid injury.

Do not step onto an unstable bench when cleaning the unit to avoid injury.

Do not place a vase or water container on the unit. Water may enter the unit and degrade the insulation. This may cause an electric shock.

Do not open window or door for long time during operation, it may lead to inefficient power usage and uncomfortable temperature changes.

Safety precautions

- ! Prevent water leakage by ensuring drainage pipe is:
 - Connected properly,
 - Kept clear of gutters and containers, or
 - Not immersed in water

After a long period of use or use with any combustible equipment, aerate the room regularly.

After a long period of use, make sure the installation rack does not deteriorate to prevent the unit from falling down.

Remote control

- ! Do not use rechargeable (Ni-Cd) batteries. It may damage the remote control.

- ! To prevent malfunction or damage of the remote control:
 - Remove the batteries if the unit is not going to be used for a long period of time.
 - New batteries of the same type must be inserted following the polarity stated.

Power supply

- ! Do not disconnect the plug by pulling the cord to prevent electric shock.

Precaution for using R32 refrigerant

The basic installation work procedures are the same as conventional refrigerant (R410A, R22) models.

- ! **1. Installation (Space)**
 - Must ensure the installation of pipe-work shall be kept to a minimum. Avoid use dented pipe and do not allow acute bending.
 - Must ensure that pipe-work shall be protected from physical damage.
 - Must comply with national gas regulations, state municipal rules and legislation. Notify relevant authorities in accordance with all applicable regulations.
 - Must ensure mechanical connections be accessible for maintenance purposes.
 - In cases that require mechanical ventilation, ventilation openings shall be kept clear of obstruction.
 - When disposal of the product, do follow to the precautions in #12 and comply with national regulations. Always contact to local municipal offices for proper handling.

- ! **2. Servicing**
 - 2-1. Service personnel**
 - Any qualified person who is involved with working on or breaking into a refrigerant circuit should hold a current valid certificate from an industry-accredited assessment authority, which authorizes their competence to handle refrigerants safely in accordance with an industry recognised assessment specification.
 - Servicing shall only be performed as recommended by the equipment manufacturer. Maintenance and repair requiring the assistance of other skilled personnel shall be carried out under the supervision of the person competent in the use of flammable refrigerants.
 - Servicing shall be performed only as recommended by the manufacturer.

- ! **2-2. Work**
 - Prior to beginning work on systems containing flammable refrigerants, safety checks are necessary to ensure that the risk of ignition is minimised. For repair to the refrigerating system, the precautions in #2-2 to #2-8 must be followed before conducting work on the system.
 - Work shall be undertaken under a controlled procedure so as to minimize the risk of a flammable gas or vapour being present while the work is being performed.
 - All maintenance staff and others working in the local area shall be instructed and supervised on the nature of work being carried out.
 - Avoid working in confined spaces.
 - Wear appropriate protective equipment, including respiratory protection, as conditions warrant.
 - Ensure that the conditions within the area have been made safe by limit of use of any flammable material. Keep all sources of ignition and hot metal surfaces away.

- ! **2-3. Checking for presence of refrigerant**
 - The area shall be checked with an appropriate refrigerant detector prior to and during work, to ensure the technician is aware of potentially flammable atmospheres.
 - Ensure that the leak detection equipment being used is suitable for use with flammable refrigerants, i.e. non sparking, adequately sealed or intrinsically safe.
 - In case of leakage/spillage happened, immediately ventilate area and stay upwind and away from spill/release.
 - In case of leakage/spillage happened, do notify persons down wind of the leaking/spill, isolate immediate hazard area and keep unauthorized personnel out.

**2-4. Presence of fire extinguisher**

- If any hot work is to be conducted on the refrigeration equipment or any associated parts, appropriate fire extinguishing equipment shall be available at hand.
- Have a dry powder or CO² fire extinguisher adjacent to the charging area.

**2-5. No ignition sources**

- No person carrying out work in relation to a refrigeration system which involves exposing any pipe work that contains or has contained flammable refrigerant shall use any sources of ignition in such a manner that it may lead to the risk of fire or explosion. He/She must not be smoking when carrying out such work.
- All possible ignition sources, including cigarette smoking, should be kept sufficiently far away from the site of installation, repairing, removing and disposal, during which flammable refrigerant can possibly be released to the surrounding space.
- Prior to work taking place, the area around the equipment is to be surveyed to make sure that there are no flammable hazards or ignition risks.
- "No Smoking" signs shall be displayed.

**2-6. Ventilated area**

- Ensure that the area is in the open or that it is adequately ventilated before breaking into the system or conducting any hot work.
- A degree of ventilation shall continue during the period that the work is carried out.
- The ventilation should safely disperse any released refrigerant and preferably expel it externally into the atmosphere.

**2-7. Checks to the refrigeration equipment**

- Where electrical components are being changed, they shall be fit for the purpose and to the correct specification.
- At all times the manufacturer's maintenance and service guidelines shall be followed.
- If in doubt consult the manufacturer's technical department for assistance.
- The following checks shall be applied to installations using flammable refrigerants.
 - The charge size is in accordance with the room size within which the refrigerant containing parts are installed.
 - The ventilation machinery and outlets are operating adequately and are not obstructed.
 - If an indirect refrigerating circuit is being used, the secondary circuit shall be checked for the presence of refrigerant.
 - Marking to the equipment continues to be visible and legible. Markings and signs that are illegible shall be corrected.
 - Refrigeration pipe or components are installed in a position where they are unlikely to be exposed to any substance which may corrode refrigerant containing components, unless the components are constructed of materials which are inherently resistant to being corroded or are properly protected against being so corroded.

**2-8. Checks to electrical devices**

- Repair and maintenance to electrical components shall include initial safety checks and component inspection procedures.
- Initial safety checks shall include but not limit to:-
 - That capacitors are discharged: this shall be done in a safe manner to avoid possibility of sparking.
 - That there no live electrical components and wiring are exposed while charging, recovering or purging the system.
 - That there is continuity of earth bonding.
- At all times the manufacturer's maintenance and service guidelines shall be followed.
- If in doubt consult the manufacturer's technical department for assistance.
- If a fault exists that could compromise safety, then no electrical supply shall be connected to the circuit until it is satisfactorily dealt with.
- If the fault cannot be corrected immediately but it is necessary to continue operation, an adequate temporary solution shall be used.
- The owner of the equipment must be informed or reported so all parties are advised thereafter.

**3. Repairs to sealed components**

- During repairs to sealed components, all electrical supplies shall be disconnected from the equipment being worked upon prior to any removal of sealed covers, etc.
 - If it is absolutely necessary to have an electrical supply to equipment during servicing, then a permanently operating form of leak detection shall be located at the most critical point to warn of a potentially hazardous situation.
 - Particular attention shall be paid to the following to ensure that by working on electrical components, the casing is not altered in such a way that the level of protection is affected.
 - This shall include damage to cables, excessive number of connections, terminals not made to original specification, damage to seals, incorrect fitting of glands, etc.
 - Ensure that apparatus is mounted securely.
 - Ensure that seals or sealing materials have not degraded such that they no longer serve the purpose of preventing the ingress of flammable atmospheres.
 - Replacement parts shall be in accordance with the manufacturer's specifications.
- NOTE: The use of silicon sealant may inhibit the effectiveness of some types of leak detection equipment.
- Intrinsically safe components do not have to be isolated prior to working on them.

Safety precautions



4. Repair to intrinsically safe components

- Do not apply any permanent inductive or capacitance loads to the circuit without ensuring that this will not exceed the permissible voltage and current permitted for the equipment in use.
- Intrinsically safe components are the only types that can be worked on while live in the presence of a flammable atmosphere.
- The test apparatus shall be at the correct rating.
- Replace components only with parts specified by the manufacturer. Unspecified parts by manufacturer may result ignition of refrigerant in the atmosphere from a leak.



5. Cabling

- Check that cabling will not be subject to wear, corrosion, excessive pressure, vibration, sharp edges or any other adverse environmental effects.
- The check shall also take into account the effects of aging or continual vibration from sources such as compressors or fans.



6. Detection of flammable refrigerants

- Under no circumstances shall potential sources of ignition be used in the searching or detection of refrigerant leaks.
- A halide torch (or any other detector using a naked flame) shall not be used.



7. Leak detection methods

- Electronic leak detectors shall be used to detect flammable refrigerants, but the sensitivity may not be adequate, or may need re-calibration. (Detection equipment shall be calibrated in a refrigerant-free area.)
- Ensure that the detector is not a potential source of ignition and is suitable for the refrigerant used.
- Leak detection equipment shall be set at a percentage of the LFL of the refrigerant and shall be calibrated to the refrigerant employed and the appropriate percentage of gas (25 % maximum) is confirmed.
- Leak detection fluids are suitable for use with most refrigerants but the use of detergents containing chlorine shall be avoided as the chlorine may react with the refrigerant and corrode the copper pipe-work.
- If a leak is suspected, all naked flames shall be removed/extinguished.
- If a leakage of refrigerant is found which requires brazing, all of the refrigerant shall be recovered from the system, or isolated (by means of shut off valves) in a part of the system remote from the leak. Oxygen free nitrogen (OFN) shall then be purged through the system both before and during the brazing process.



8. Removal and evacuation

- When breaking into the refrigerant circuit to make repairs – or for any other purpose – conventional procedures shall be used. However, it is important that best practice is followed since flammability is a consideration. The following procedure shall be adhered to: remove refrigerant -> purge the circuit with inert gas -> evacuate -> purge again with inert gas -> open the circuit by cutting or brazing
- The refrigerant charge shall be recovered into the correct recovery cylinders.
- The system shall be “flushed” with OFN to render the unit safe.
- This process may need to be repeated several times.
- Compressed air or oxygen shall not be used for this task.
- Flushing shall be achieved by breaking the vacuum in the system with OFN and continuing to fill until the working pressure is achieved, then venting to atmosphere, and finally pulling down to a vacuum.
- This process shall be repeated until no refrigerant is within the system.
- When the final OFN charge is used, the system shall be vented down to atmospheric pressure to enable work to take place.
- This operation is absolutely vital if brazing operations on the pipe work are to take place.
- Ensure that the outlet for the vacuum pump is not close to any ignition sources and there is ventilation available.



9. Charging procedures

- In addition to conventional charging procedures, the following requirements shall be followed.
 - Ensure that contamination of different refrigerants does not occur when using charging equipment.
 - Hoses or lines shall be as short as possible to minimize the amount of refrigerant contained in them.
 - Cylinders shall be kept upright.
 - Ensure that the refrigeration system is earthed prior to charging the system with refrigerant.
 - Label the system when charging is complete (if not already).
 - Extreme care shall be taken not to over fill the refrigeration system.
- Prior to recharging the system it shall be pressure tested with OFN (refer to #7).
- The system shall be leak tested on completion of charging but prior to commissioning.
- A follow up leak test shall be carried out prior to leaving the site.
- Electrostatic charge may accumulate and create a hazardous condition when charging and discharging the refrigerant. To avoid fire or explosion, dissipate static electricity during transfer by grounding and bonding containers and equipment before charging/discharging.

**10. Decommissioning**

- Before carrying out this procedure, it is essential that the technician is completely familiar with the equipment and all its details.
- It is recommended good practice that all refrigerants are recovered safely.
- Prior to the task being carried out, an oil and refrigerant sample shall be taken in case analysis is required prior to re-use of reclaimed refrigerant.
- It is essential that electrical power is available before the task is commenced.
 - a) Become familiar with the equipment and its operation.
 - b) Isolate system electrically.
 - c) Before attempting the procedure ensure that:
 - mechanical handling equipment is available, if required, for handling refrigerant cylinders;
 - all personal protective equipment is available and being used correctly;
 - the recovery process is supervised at all times by a competent person;
 - recovery equipment and cylinders conform to the appropriate standards.
 - d) Pump down refrigerant system, if possible.
 - e) If a vacuum is not possible, make a manifold so that refrigerant can be removed from various parts of the system.
 - f) Make sure that cylinder is situated on the scales before recovery takes place.
 - g) Start the recovery machine and operate in accordance with manufacturer's instructions.
 - h) Do not over fill cylinders. (No more than 80 % volume liquid charge).
 - i) Do not exceed the maximum working pressure of the cylinder, even temporarily.
 - j) When the cylinders have been filled correctly and the process completed, make sure that the cylinders and the equipment are removed from site promptly and all isolation valves on the equipment are closed off.
 - k) Recovered refrigerant shall not be charged into another refrigeration system unless it has been cleaned and checked.
- Electrostatic charge may accumulate and create a hazardous condition when charging or discharging the refrigerant. To avoid fire or explosion, dissipate static electricity during transfer by grounding and bonding containers and equipment before charging/discharging.

**11. Labelling**

- Equipment shall be labelled stating that it has been de-commissioned and emptied of refrigerant.
- The label shall be dated and signed.
- Ensure that there are labels on the equipment stating the equipment contains flammable refrigerant.

**12. Recovery**

- When removing refrigerant from a system, either for servicing or decommissioning, it is recommended good practice that all refrigerants are removed safely.
- When transferring refrigerant into cylinders, ensure that only appropriate refrigerant recovery cylinders are employed.
- Ensure that the correct number of cylinders for holding the total system charge are available.
- All cylinders to be used are designated for the recovered refrigerant and labelled for that refrigerant (i.e. special cylinders for the recovery of refrigerant).
- Cylinders shall be complete with pressure relief valve and associated shut-off valves in good working order.
- Recovery cylinders are evacuated and, if possible, cooled before recovery occurs.
- The recovery equipment shall be in good working order with a set of instructions concerning the equipment that is at hand and shall be suitable for the recovery of flammable refrigerants.
- In addition, a set of calibrated weighing scales shall be available and in good working order.
- Hoses shall be complete with leak-free disconnect couplings and in good condition.
- Before using the recovery machine, check that it is in satisfactory working order, has been properly maintained and that any associated electrical components are sealed to prevent ignition in the event of a refrigerant release. Consult manufacturer if in doubt.
- The recovered refrigerant shall be returned to the refrigerant supplier in the correct recovery cylinder, and the relevant Waste Transfer Note arranged.
- Do not mix refrigerants in recovery units and especially not in cylinders.
- If compressors or compressor oils are to be removed, ensure that they have been evacuated to an acceptable level to make certain that flammable refrigerant does not remain within the lubricant.
- The evacuation process shall be carried out prior to returning the compressor to the suppliers.
- Only electric heating to the compressor body shall be employed to accelerate this process.
- When oil is drained from a system, it shall be carried out safely.

How to use

MODE To select operation mode

AUTO - For your convenience

- Unit run with optimised settings.
- You can change the temperature according to your comfort.

COOL - To enjoy cool air

- To reduce power consumption during COOL mode, use curtains to screen off sunlight and outdoor heat.

DRY - To dehumidify the environment

- Unit operates at low fan speed to give a gentle cooling operation.

FAN - To operate Air-Con in "Fan Only" mode

- Only indoor unit fan operates as per remote settings.
- Outdoor is OFF, so no cooling achieved.
- Provides fresh air circulation in the room.

* Indoor unit temp. display will show set temp. for AUTO, COOL & DRY mode and room temp. for FAN mode.

SLEEP To maximise comfort while sleeping

- This operation provides you with a comfortable environment while sleeping by gradually increase the set temperature 1 °C after 3 hours operation.
- The unit is turned off after 8 hours.
- Can be cancelled by pressing the respective button again.

POWERFUL To reach temperature quickly

- This operation is to achieve faster cooling.



Remote control receiver and indicator

- POWER (Green)
- TIMER (Orange)
- SLEEP (Blue)
- POWERFUL (Orange)
- 25°C (Temperature display)

Remote control display

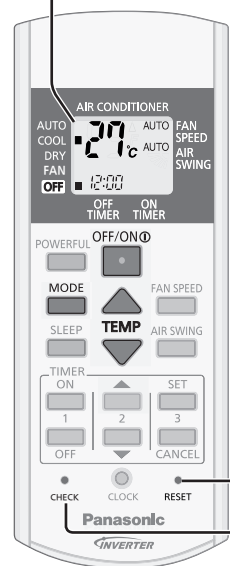

Press to restore the remote control to default setting.

Not used in normal operations.

To adjust horizontal airflow direction

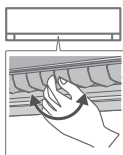

- Manually adjustable.

Auto OFF/ON button



- Use when remote control is misplaced or a malfunction occurs. Raise the front panel:
- Press the button to turn on.
- Press the button again to turn off.

Temperature display

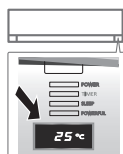

- The unit displays set temperature.

FAN SPEED
 To select fan speed

(Remote control display)

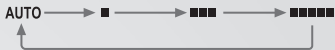

- For AUTO, the indoor fan speed is automatically adjusted according to the operation mode.

AIR SWING
 To adjust vertical airflow direction

(Remote control display)



- Keeps the room ventilated.
- If AUTO is set, the louver swings up/down automatically.
- Do not adjust the louver by hand.

Auto Restart Control

- If power is resumed after a power failure, the operation will restart automatically after a period of time with previous operation mode and airflow direction.
- POWERFUL, SLEEP and TIMER function will not resume after power failure.

To set the timer

To turn ON or OFF the unit at a preset time.

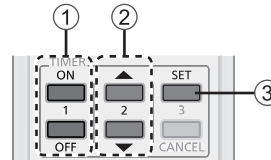

- ① **Select ON or OFF timer**

Example:
OFF at 22:00



- ② **Set the time**



- ③ **Confirm**



- To cancel ON or OFF timer, press ON or OFF then press CANCEL.
- If timer is cancelled manually or due to power failure, you can restore the timer again by pressing ON or OFF then press SET.
- The nearest timer setting will be displayed and will activate in sequence.
- When ON Timer is set, the unit may start earlier (up to 15 minutes) before the actual set time in order to achieve the desired temperature on time.
- Timer operation is based on the clock set in the remote control and repeats daily once set. For clock setting, please refer to Quick guide.

Operation conditions

Use this air conditioner under the following temperature range.

DBT : Dry bulb temperature
 WBT : Wet bulb temperature

Temperature (°C)	Indoor		Outdoor		
	DBT	WBT	DBT	WBT	
COOL	Max.	35	24	50	30
	Min.	16	11	16	11

Cleaning instructions

To ensure optimal performance of the unit, cleaning has to be carried out at regular intervals. Please consult authorised dealer.

- Switch off the power supply and unplug before cleaning.
- Do not touch the aluminium fin, sharp parts may cause injury.
- Do not use benzine, thinner or scouring powder.
- Use only soap (\approx pH 7) or neutral household detergent.
- Do not use water hotter than 40 °C.

Indoor unit

Wipe the unit gently with a soft, dry cloth.



Front panel

Wash gently and dry.

Remove the front panel

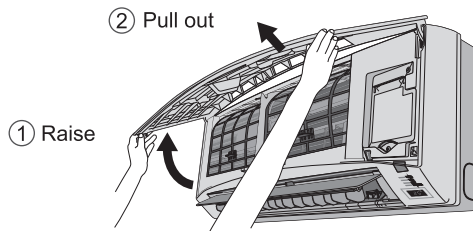

Close it securely

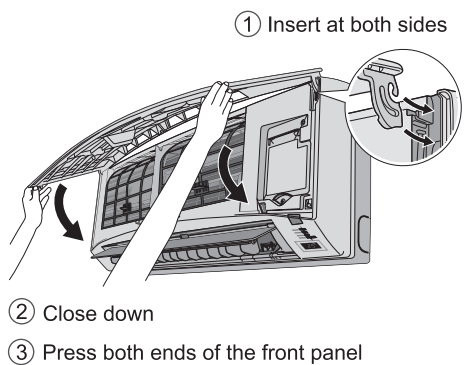

Indoor unit

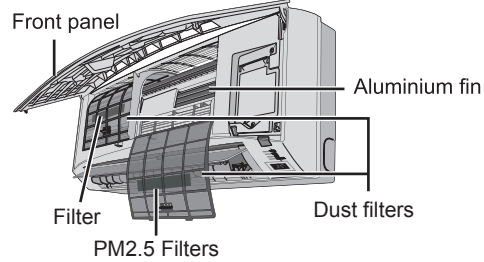

Dust filters

Every 2 weeks



- Wash/rinse the dust filters gently with water to avoid damage to the filter surface.
- Dry the dust filters thoroughly under shade, away from fire or direct sunlight.
- Replace any damaged filters.
- Please remove the Filter / PM2.5 Filter before wash/rinse the dust filter with water.

Remove air filter

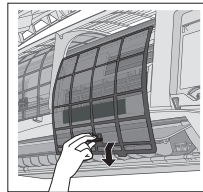

Attach air filter

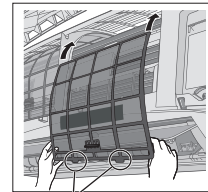

Insert into the unit

Filter & PM 2.5 filter



- Clean the filter whenever necessary.
- Don't wash/rinse the filter with water.
- The surface of the filter shouldn't be rubbed with any object.
- The filter shouldn't be pulled with strong force as it may get damaged.

For seasonal inspection after extended non-use

- Checking of remote control batteries.
- No obstruction at air inlet and air outlet vents.
- After 15 minutes of operation, it is normal to have the following temperature difference between air inlet and air outlet vents:

COOL: ≥ 8 °C

For extended non-use

- Turn off the power supply and unplug.
- Remove the remote control batteries.

Troubleshooting

The following symptoms do not indicate malfunction.

Symptom	Cause
Mist emerges from indoor unit.	• Condensation effect due to cooling process.
Water flowing sound during operation.	• Refrigerant flow inside the unit.
The room has a peculiar odour.	• This may be due to damp smell emitted by the wall, carpet, furniture or clothing.
Indoor fan stops occasionally during automatic fan speed setting.	• This helps to remove the surrounding odour.
Operation is delayed a few minutes after restarting.	• The delay is a protection to the unit's compressor.
Outdoor unit emits water/steam.	• Condensation or evaporation occurs on pipes.
TIMER indicator is always on.	• The timer setting repeats daily once set.
Cracking sound during operation.	• Changes of temperature caused the expansion/contraction of the unit.
Discoloration of some plastic parts.	• Discoloration is subject to material types used in plastic parts, accelerated when exposed to heat, sun light, UV light, or environmental factor.

Check the following before calling for servicing.

Symptom	Check
Operation in COOL mode is not working efficiently.	<ul style="list-style-type: none"> • Set the temperature correctly. • Close all doors and windows. • Clean or replace the filters. • Clear any obstruction at the air inlet and air outlet vents.
Noisy during operation.	<ul style="list-style-type: none"> • Check if the unit has been installed at an incline. • Close the front panel properly.
Remote control does not work. (Display is dim or transmission signal is weak.)	<ul style="list-style-type: none"> • Insert the batteries correctly. • Replace weak batteries.
The unit does not work.	<ul style="list-style-type: none"> • Check if the circuit breaker is tripped. • Check if timers have been set.
The unit does not receive the signal from the remote control.	<ul style="list-style-type: none"> • Make sure the receiver is not obstructed. • Certain fluorescent lights may interfere with signal transmitter. Please consult authorised dealer.

NON SERVICEABLE CRITERIAS

TURN OFF POWER SUPPLY AND UNPLUG then please consult authorised dealer under the following conditions:

- Abnormal noise during operation.
- Water/foreign particles have entered the remote control.
- Water leaks from Indoor unit.
- Circuit breaker switches off frequently.
- Power cord becomes unnaturally warm.
- Switches or buttons are not functioning properly.
- The unit stops and some alpha-numeric codes appear on IDU display.

BEE Regulation

Testing Guidelines

Cooling Test Mode for Full Load (100%) and Half Load (50%)

- Turn on the main power supply to unit.

- 1) Mode : Select 'COOL'
- 2) Temperature : a) 16 °C for Full Load (100%)
: b) 17 °C for Half Load (50%)
- 3) Air Swing : Set vane position to 3rd step from top
- 4) Fan speed : Maximum

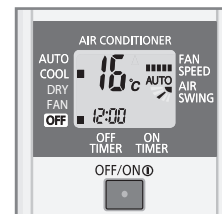

(For Full Load)

- Open the Front Panel by lifting Intake Grille.
- Follow the below Instructions.

Step a): Press and Hold the (Auto OFF/ON) button on indoor Unit.

Step b): Within 5 second, press once the Remote Control  button when display is showing OFF, while holding the indoor unit button.

Step c): After hearing a beep sound from the Indoor Unit, immediately release the (Auto OFF/ON) button on Indoor Unit.

All this should be done within 5 seconds.

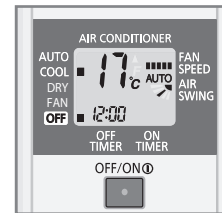

(For Half Load)

- The POWER indication LED on indoor unit gets dim when the unit enters the test mode.

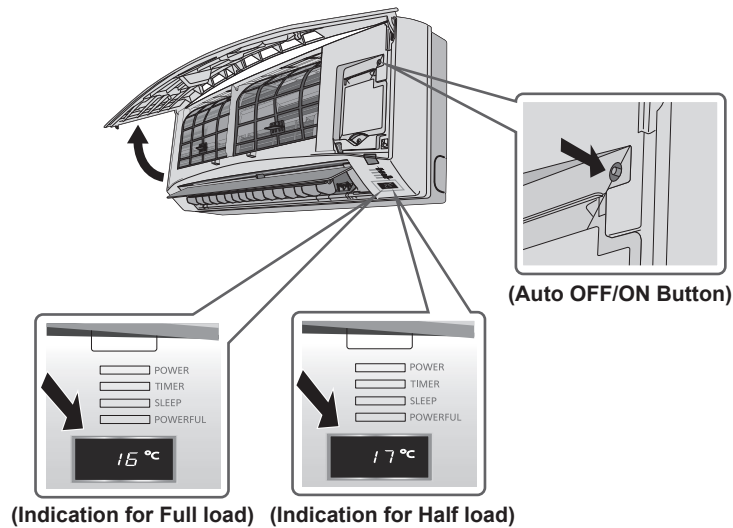

Information

English

Information on hazardous constituents as specified in sub-rule 1 of rule 16 (1) in electrical and electronic equipment.

Declaration of Conformity with the requirements of the E-Waste (Management) Amendment Rules 2018 with the rule 16 (1) limits with respect to Lead, Mercury, Cadmium, Hexavalent chromium, Polybrominated biphenyls, Polybrominated diphenyl ethers.

The content of hazardous substance with the exemption of the applications listed in SCHEDULE II of the E-Waste (Management) Amendment Rules 2018 :

1. Lead (Pb) – not over 0.1% by weight;
2. Cadmium (Cd) – not over 0.01% by weight;
3. Mercury (Hg) – not over 0.1% by weight;
4. Hexavalent chromium (Cr6+) – not over 0.1% by weight;
5. Polybrominated biphenyls (PBBs) – not over 0.1% by weight;
6. Polybrominated diphenyl ethers (PBDEs) – not over 0.1% by weight.



For the purpose of recycling to facilitate effective utilization of resources, please return this product to a nearby authorized collection center, registered dismantler or recycler, or Panasonic service center when disposing of this product.





Customer care number (Toll free) : 1800 103 1333 , 1800 108 1333

Please see the Panasonic website for further information on collection centers, etc. or call the customer care toll-free number

<http://www.panasonic.com/in/corporate/sustainability/panasonic-india-i-recycle-program.html>

Do's & Don't: E-waste (Management) Amendment Rules 2018

S.No.	Do's	Don't
1.	All electrical and electronic products are required to be handed over only to the Authorized recycler.	The product should not be opened by the User himself / herself, but only by authorized service personnel.
2.	The product should be handed over only to authorized recycler for disposal.	The product is not meant for re-sale to any unauthorized agencies / scrap dealer / kabari-walas.
3.	Keep the product in isolated area, after it becomes non-functional / un-repairable so as to prevent its accidental breakage.	The product is not meant for mixing into household waste stream.
4.	Provide information on the catalogue with product end-of-life.	Do not keep any replaced spare part(s) from the product in exposed area.
5.	Always dispose products that have reached end-of life at Panasonic India Authorized Service Centre.	Do not donate old electronic items to any body. Do not dispose your product in garbage bins along with municipal waste that ultimately reaches landfill.
6.	Wherever possible or as instructed, separate the packaging material according to responsible waste disposal options and sorting for recycling.	Do not give e-waste to informal and unorganized sectors like Local Scrap Dealer / Rag Pickers.

 WARNING	This symbol shows that this equipment uses a flammable refrigerant. If the refrigerant is leaked, together with an external ignition source, there is a possibility of ignition.		This symbol shows that the Operation Instructions should be read carefully.
	This symbol shows that a service personnel should be handling this equipment with reference to the Installation Instructions.		This symbol shows that there is information included in the Operation Instructions and/or Installation Instructions.

Panasonic Corporation

Website: <http://www.panasonic.com>

© Panasonic Corporation 2019

Printed in India

ACXF55-22410-AA
FT0918-0