

Wall-Mounted

Panasonic Wall-Mounted types are suitable for residential. These air conditioners giving you greater comfort and energy savings.



Slim Ducted

Panasonic Slim Ducted types are available in middle static pressure power. These air conditioners are suitable for applications in concealed or false ceilings such as business centers.

INDEX

02 - 03

Index
Range of Indoor Units

04 - 05

Wall Mounted
Slim Ducted

06 - 15

Product Line-up











16 - 17

Features Comparison and Explanation
RAC Interface Adaptor

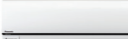
18 - 19

Indoor Dimensions - Wall-Mounted
Indoor Dimensions - Slim Ducted

Range of Indoor Units

Capacity	2.8kW	3.2kW	4.0kW	5.0kW	6.0kW	7.0kW
Wall-Mounted						
		CS-MPS9SKH	CS-MPS12SKH	CS-MPS15SKH	CS-MPS18SKH	CS-MPS24SKH
						CS-MPS28SKH
Slim Ducted						
		CS-MS9SD3H	CS-MS12SD3H	CS-MS18SD3H	CS-MS24SD3H	

Wall-Mounted

The wall mounted unit has a stylish smooth design with a washable front panel. Small, lightweight and low noise level makes it ideal for residential and other light commercial applications.

Technical focus

- Lighter and smaller units make installation easy
- Smooth and durable design
- Washable front panel
- Anti-mould washable filters are included
- Anti-bacterial filter to provide clean air



How Anti-Bacterial Filter works

EFFECTIVENESS	TARGET SUBSTANCE AND SUBSTANCE NAME	MECHANISM
<p>DEACTIVATES</p> <p>UP TO 99%</p> <p>of filter-captured Bacteria *1</p>	<p>Anti-bacterial</p> <p>*1 Bacteria deactivation was certified by Boken Quality Evaluation Institute. Test Report No: 10042459-1 and 10042459-2 Bacteria: <i>Staphylococcus aureus</i> NBRC 12732 : <i>Escherichia coli</i> NBRC 3972</p>	<p>Artificial Enzyme</p> <p>Bacteria is caught by the filter. Artificial Enzyme will attach to surface of bacteria. Cell-wall is covered by Artificial Enzyme. Bacteria becomes inactive by preventing its growth.</p> <p>Remark: The above are not actual images of target substance structure. Image drawn is for illustration purpose.</p>
<p>UP TO 99%</p> <p>of filter-captured Viruses *2</p>	<p>Anti-virus</p> <p>*2 Virus deactivation was certified by Osaka Prefectural Institute of Public Health. Test Report No: 313360397 Virus: Influenza (H3N2) A/Hong Kong</p>	<p>Disinfectant</p> <p>The virus is caught by the filter. Disinfectant will attach to surface protein of virus. Spikes are covered by Disinfectant. Virus becomes inactive through 'tanning effect' making them harmless.</p> <p>Remark: The above are not actual images of target substance structure. Image drawn is for illustration purpose.</p>
<p>DEACTIVATES</p> <p>UP TO 99%</p> <p>of filter-captured Allergen *3</p>	<p>Anti-allergen</p> <p>*3 Allergen deactivation was certified by Shinshu University. Test Report No: Allergen: Cider Pollen Allergen Cry j1</p>	<p>Artificial Enzyme</p> <p>The allergen is caught by the filter. Artificial Enzyme will 'denature' the filter-captured allergen. Allergen loses original properties or characteristic. 'Denatured' allergen will no longer keep its original property as allergen; therefore, it is harmless.</p> <p>When allergen is denatured, the strand of amino acid is "teased" apart hence changing the shape. In this way, allergen will lose its original properties or characteristic as allergen, thus making them harmless.</p> <p>Remark: The above are not actual images of target substance structure. Image drawn is for illustration purpose.</p>
<p>INHIBITS</p> <p>Mould *4</p> <p>Growth</p>	<p>Anti-mould</p> <p>*4 Certified by Boken Quality Evaluation Institute. Test Report No: 000366-3 Mould: <i>Aspergillus niger</i> ATCC 6275</p>	<p>The mould will be caught by the filter. Fungicide will attach to surface protein of mould. Fungicide inhibits mould from growing by preventing the cell-wall composition.</p>

Applicable Models: MPS9, 12, 15, 18, 24, 28SKH

Slim Low Static Ducted



Concealed duct

The ultra slim type is one of the leading products of its type in the industry. With a height of only 200 mm, it provides greater flexibility and adaptability for various applications. In addition, high efficiency and extreme low noise level make it highly suitable for hotels and other light commercial applications.

Technical focus

- Ultra-slim profile: 200 mm for all models
- DC fan motor greatly reduces power consumption
- Ideal for hotel application with very narrow false ceilings
- Anti-mould washable filters included
- Easy maintenance and service by external electrical box
- Includes drain pump

Ultra-slim profile for all models



200mm height for all models allows installation in very narrow ceilings.

Drain pump with increased power!

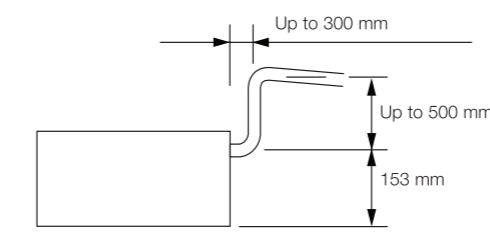

Using the built-in high-lift drain pump, the drain piping rise height can be increased to 653 mm from the lower surface of the body.

ADVANTAGES OF THE MULTI INVERTER SYSTEM

Indoor unit

Outdoor unit

A variety of indoor units

Air-quality features (Wall-Mounted type only)

- Anti-Bacterial Filter

Adjusts the operation settings for each indoor unit independently

Space-saving

Single Split Type CU-S10TKH

With a single outdoor unit, control up to 4 indoor units. (Maximum)

BIG SPACE SAVINGS!

CU-4S27SBH

Inverter control

The inverter offers energy-saving efficiency, quick comfort, and flexible power control. Our compressor saves more energy while reducing vibration, noise and unit size.

WALL MOUNTED



CS-MPS9SKH (2.8kW) / CS-MPS12SKH (3.2kW) / CS-MPS15SKH (4.0kW)



CS-MPS18SKH (5.0kW) / CS-MPS24SKH (6.0kW) / CS-MPS28SKH (7.0kW)



Wireless



Wired (Optional)

COOLING MODELS

SLIM DUCTED

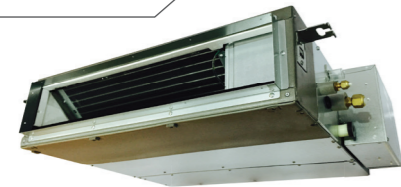

CS-MS9SD3H (2.8kW) / CS-MS12SD3H (3.2kW) / CS-MS18SD3H (5.0kW) / CS-MS24SD3H (6.0kW)



Wireless



Wired (Optional)

COOLING MODELS

Models	CU-2S18SKH	Indoor Units: Possible Combination Patterns (Must be within capacity range)
2 Rooms		Port A: 2.8 or 3.2 Port B: 2.8 or 3.2

- It is possible to have a combination of wall-mounted models (MPS9 & 12SKH) and Slim Ducted (CS-MS9 & 12SD3H) for the (CU-2S18SKH) Outdoor Unit Ports.
- A minimum of 2 indoor units must be connected.

Models	CU-3S27SBH	Indoor Units: Possible Combination Patterns (Must be within capacity range)
3 Rooms		Port A: 2.8 or 3.2 or 4.0 or 5.0 Port B: 2.8 or 3.2 or 4.0 or 5.0 Port C: 2.8 or 3.2 or 4.0 or 5.0

- It is possible to have a combination of wall-mounted models (MPS9, 12, 15, 18SKH) and Slim Ducted (CS-MS9, 12, 18SD3H) for the (CU-3S27SBH) Outdoor Unit Ports.
- A minimum of 2 indoor units must be connected.

Models	CU-3S28SBH	Indoor Units: Possible Combination Patterns (Must be within capacity range)
3 Rooms		Port A: 2.8 or 3.2 or 4.0 or 5.0 or 6.0 Port B: 2.8 or 3.2 or 4.0 or 5.0 or 6.0 Port C: 2.8 or 3.2 or 4.0 or 5.0 or 6.0

- It is possible to have a combination of wall-mounted models (MPS9, 12, 15, 18, 24SKH) and Slim Ducted (CS-MS9, 12, 18, 24SD3H) for the (CU-3S28SBH) Outdoor Unit Ports.
- A minimum of 2 indoor units must be connected.

Models	CU-4S27SBH	Indoor Units: Possible Combination Patterns (Must be within capacity range)
4 Rooms		Port A: 2.8 or 3.2 or 4.0 or 5.0 Port B: 2.8 or 3.2 or 4.0 or 5.0 Port C: 2.8 or 3.2 or 4.0 or 5.0 Port D: 2.8 or 3.2 or 4.0 or 5.0

- It is possible to have a combination of wall-mounted models (MPS9, 12, 15, 18SKH) and Slim Ducted (CS-MS9, 12, 18SD3H) for the (CU-4S27SBH) Outdoor Unit Ports.
- A minimum of 2 indoor units must be connected.

Models	CU-4S34SBH	Indoor Units: Possible Combination Patterns (Must be within capacity range)
4 Rooms		Port A: 2.8 or 3.2 or 4.0 or 5.0 or 6.0 or 7.0 Port B: 2.8 or 3.2 or 4.0 or 5.0 or 6.0 or 7.0 Port C: 2.8 or 3.2 or 4.0 or 5.0 or 6.0 or 7.0 Port D: 2.8 or 3.2 or 4.0 or 5.0 or 6.0 or 7.0

- It is possible to have a combination of wall-mounted models (MPS9, 12, 15, 18, 24, 28SKH) and Slim Ducted (CS-MS9, 12, 18, 24SD3H) for the (CU-4S34SBH) Outdoor Unit Ports.
- A minimum of 2 indoor units must be connected.

SPECIFICATIONS - INDOOR (Wall Mounted)

MODEL			CS-MPS9SKH	CS-MPS12SKH	CS-MPS15SKH	CS-MPS18SKH	CS-MPS24SKH	CS-MPS28SKH
Operation			1-Unit	1-Unit	1-Unit	1-Unit	1-Unit	1-Unit
Cooling Capacity	Btu/h		9,550	10,900	13,600	17,100	20,500	23,900
	kW		2.80	3.20	4.00	5.00	6.00	7.00
Electrical Data	Voltage	V	220 - 240	220 - 240	220 - 240	220 - 240	220 - 240	220 - 240
Sound Pressure Level	Indoor (Hi/Lo)	(dB-A)	40 / 29	44 / 32	45 / 32	47 / 38	48 / 39	48 / 39
Moisture Removal	L/h		1.6	1.8	2.3	2.7	3.3	3.9
Air Circulation (Indoor/Hi)	m ³ /min.		10.1	10.9	11.2	18.1	18.5	19.0
	cfm		355	385	395	640	655	670
Fan Output	W		24	24	24	40	40	40
Dimensions	Height	mm	290	290	290	290	290	290
	Width	mm	870	870	870	1,070	1,070	1,070
	Depth	mm	214	214	214	240	240	240
Net Weight Indoor	kg		9	9	9	12	12	12
Refrigerant Pipe Diameter	Liquid Side	mm	ø 6.35	ø 6.35	ø 6.35	ø 6.35	ø 6.35	ø 6.35
	Gas Side	mm	ø 9.52	ø 9.52	ø 9.52	ø 9.52	ø 12.7	ø 12.7
Power Supply			Outdoor	Outdoor	Outdoor	Outdoor	Outdoor	Outdoor

SPECIFICATIONS - INDOOR (Slim Ducted)

MODEL			CS-MS9SD3H	CS-MS12SD3H	CS-MS18SD3H	CS-MS24SD3H
Operation			1-Unit	1-Unit	1-Unit	1-Unit
Cooling Capacity	Btu/h		9,550	10,900	17,100	20,500
	kW		2.80	3.20	5.00	6.00
Electrical Data	Voltage	V	220 - 240	220 - 240	220 - 240	220 - 240
Sound Pressure Level	Indoor (Hi/Lo)	(dB-A)	35 / 28	35 / 28	41 / 30	41 / 30
Air Circulation (Indoor/Hi)	m ³ /min.		13.2	13.2	15.5	15.5
	cfm		465	465	545	545
Dimensions	Height	mm	200	200	200	200
	Width	mm	750	750	750	750
	Depth	mm	640	640	640	640
Net Weight Indoor	kg		19	19	19	19
Refrigerant Pipe Diameter	Liquid Side	mm	ø 6.35	ø 6.35	ø 6.35	ø 6.35
	Gas Side	mm	ø 9.52	ø 9.52	ø 9.52	ø 12.7
Power Supply			Outdoor	Outdoor	Outdoor	Outdoor

SPECIFICATIONS - OUTDOOR

MODEL			DUAL-SPLIT MODEL	TRIPLE-SPLIT MODEL	QUADRUPLE-SPLIT MODEL		
MODEL			CU-2S18SKH	CU-3S27SBH	CU-3S28SBH	CU-4S27SBH	CU-4S34SBH
Cooling Capacity	Btu/h (Min ~ Max)		17,100 (5,120~20,500)	25,600 (9,550~27,300)	25,600 (9,550~30,700)	25,600 (9,550~27,300)	34,100 (9,890~37,500)
	kW (Min ~ Max)		5.00 (1.50~6.00)	7.50 (2.80~8.00)	7.50 (2.80~9.00)	7.50 (2.80~8.00)	10.0 (2.90~11.00)
EER	Btu/hW		11.96	12.43	12.43	12.43	12.18
	W/W		3.50	3.64	3.64	3.64	3.57
Electrical Data	Voltage	V	220 - 240	220 - 240	220 - 240	220 - 240	220 - 240
	Running Current	A	6.8 - 6.2	10.2 - 9.4	10.1 - 9.2	10.2 - 9.4	13.5 - 12.4
	Power Input (Min ~ Max)	W	1,430 (250~1,780)	2,060 (520~2,650)	2,060 (520~2,830)	2,060 (520~2,530)	2,800 (560~3,460)
Sound Pressure Level	Outdoor (H)	(dB-A)	50	49	49	49	52
Maximum Current	A		12.0	15.2	15.2	15.2	21.3
Starting Current	A		6.8	10.2	10.1	10.2	13.5
Compressor Output	W		900	1,300	1,300	1,300	1,700
Fan Output	W		40	44	60	44	90
Dimensions	Height	mm	619	695	795	695	999
	Width	mm	824 (+70)	875 (+95)	875 (+95)	875(+95)	940
	Depth	mm	299	320	320	320	340
Net Weight Outdoor	kg		37	57	68	57	76
Pipe Extension**	Chargeless Pipe Length	m	20	30	30	35	45
	Maximum Pipe Length	1 Room	20	25	25	25	25
		Total	30	60	60	60	70
	Maximum Elevation Length	m	10	15	15	15	15
	Additional Refrigerant Gas*	g/m	15	20	20	20	20

* When pipes are not extended from the standard pipe length, the required amount of refrigerant is already in the unit.

INVERTER DUAL-SPLIT MODEL (CU-2S18SKH)

INDOOR UNIT COMBINATION	TOTAL	COOLING CAPACITY (kW)				POWER INPUT (W)			CURRENT (A) 220V / 240V	MOISTURE REMOVAL L/H
		A	B	TOTAL	MIN - MAX	RATED	MIN - MAX			
1 Room	28	28	2.80		2.80	1.10 ~ 3.50	0.75	0.22 ~ 1.00	3.65 / 3.40	1.6
	32	32	3.20		3.20	1.10 ~ 4.00	0.92	0.22 ~ 1.22	4.50 / 4.20	1.8
2 Room	28 + 28	56	2.40	2.40	4.80	1.50 ~ 5.80	1.34	0.25 ~ 1.72	6.50 / 6.05	1.5 + 1.5
	28 + 32	60	2.30	2.70	5.00	1.50 ~ 5.90	1.52	0.25 ~ 1.74	7.40 / 6.90	1.5 + 1.6
	32 + 32	64	2.50	2.50	5.00	1.50 ~ 6.00	1.43	0.25 ~ 1.78	6.75 / 6.25	1.5 + 1.5

INVERTER TRIPLE-SPLIT MODEL (CU-3S27SBH)

INDOOR UNIT COMBINATION	TOTAL	COOLING CAPACITY (kW)				POWER INPUT (W)			CURRENT (A) 220V / 240V	MOISTURE REMOVAL L/H	
		A	B	C	TOTAL	MIN - MAX	RATED	MIN - MAX			
1 Room	28	28	2.80		2.80	1.7 ~ 3.4	700	380 ~ 890	3.8 / 3.5	1.6	
	32	32	3.20		3.20	1.7 ~ 4.0	800	380 ~ 1,200	4.3 / 3.9	1.8	
	40	40	4.00		4.00	1.7 ~ 4.8	1,180	380 ~ 1,480	6.1 / 5.6	2.3	
	50	50	5.00		5.00	1.9 ~ 5.8	1,460	400 ~ 1,890	7.4 / 6.8	2.7	
2 Rooms	28 + 28	56	2.80	2.80	5.60	1.7 ~ 6.4	1,750	420 ~ 2,600	8.7 / 8.0	1.6 + 1.6	
	28 + 32	60	2.80	3.20	6.00	1.7 ~ 6.5	2,010	420 ~ 2,600	10.0 / 9.2	1.6 + 1.8	
	28 + 40	68	2.80	4.00	6.80	2.5 ~ 7.3	2,420	550 ~ 3,330	12.0 / 11.0	1.6 + 2.3	
	28 + 50	78	2.69	4.81	7.50	2.7 ~ 7.7	2,810	530 ~ 3,310	13.9 / 12.7	1.6 + 2.6	
	32 + 32	64	3.20	3.20	6.40	2.3 ~ 7.1	2,290	570 ~ 3,350	11.3 / 10.4	1.8 + 1.8	
	32 + 40	72	3.20	4.00	7.20	2.5 ~ 7.4	2,770	550 ~ 3,330	13.7 / 12.5	1.8 + 2.3	
	32 + 50	82	2.93	4.57	7.50	2.8 ~ 7.7	2,760	530 ~ 3,310	13.6 / 12.5	1.7 + 2.5	
	40 + 40	80	3.75	3.75	7.50	2.7 ~ 7.6	2,870	540 ~ 3,310	14.2 / 13.0	2.2 + 2.2	
	40 + 50	90	3.33	4.17	7.50	2.8 ~ 7.8	2,600	530 ~ 3,300	12.8 / 11.8	1.9 + 2.4	
	50 + 50	100	3.75	3.75	7.50	2.9 ~ 8.0	2,440	520 ~ 3,300	12.1 / 11.1	2.2 + 2.2	
3 Rooms	28 + 28 + 28	84	2.50	2.50	2.50	7.50	2.4 ~ 7.6	2,740	580 ~ 3,170	13.5 / 12.4	1.5 + 1.5 + 1.5
	28 + 28 + 32	88	2.39	2.39	2.72	7.50	2.4 ~ 7.7	2,690	580 ~ 3,170	13.3 / 12.2	1.5 + 1.5 + 1.6
	28 + 28 + 40	96	2.19	2.19	3.12	7.50	2.6 ~ 8.0	2,490	600 ~ 3,260	12.3 / 11.3	1.4 + 1.4 + 1.8
	28 + 28 + 50	106	1.98	1.98	3.54	7.50	2.8 ~ 8.0	2,250	600 ~ 2,910	11.1 / 10.2	1.3 + 1.3 + 2.0
	28 + 32 + 32	92	2.28	2.61	2.61	7.50	2.4 ~ 7.7	2,690	580 ~ 3,180	13.3 / 12.2	1.5 + 1.6 + 1.6
	28 + 32 + 40	100	2.10	2.40	3.00	7.50	2.6 ~ 8.0	2,450	600 ~ 3,200	12.1 / 11.1	1.4 + 1.5 + 1.7
	28 + 32 + 50	110	1.91	2.18	3.41	7.50	2.8 ~ 8.0	2,250	600 ~ 2,910	11.1 / 10.2	1.2 + 1.4 + 2.0
	28 + 40 + 40	108	1.94	2.78	2.78	7.50	2.7 ~ 8.0	2,290	600 ~ 3,020	11.3 / 10.4	1.3 + 1.6 + 1.6
	28 + 40 + 50	118	1.78	2.54	3.18	7.50	2.8 ~ 8.0	2,170	580 ~ 2,760	10.7 / 9.8	1.1 + 1.6 + 1.8
	28 + 50 + 50	128	1.64	2.93	2.93	7.50	2.8 ~ 8.0	2,070	520 ~ 2,650	10.2 / 9.4	1.0 + 1.7 + 1.7
	32 + 32 + 32	96	2.50	2.50	2.50	7.50	2.4 ~ 7.7	2,650	590 ~ 3,190	13.1 / 12.0	1.5 + 1.5 + 1.5
	32 + 32 + 40	104	2.31	2.31	2.88	7.50	2.6 ~ 8.0	2,450	600 ~ 3,210	12.1 / 11.1	1.5 + 1.5 + 1.7
	32 + 32 + 50	114	2.11	2.11	3.28	7.50	2.8 ~ 8.0	2,250	600 ~ 2,920	11.1 / 10.2	1.4 + 1.4 + 1.9
	32 + 40 + 40	112	2.14	2.68	2.68	7.50	2.8 ~ 8.0	2,290	600 ~ 2,960	11.3 / 10.4	1.4 + 1.6 + 1.6
	32 + 40 + 50	122	1.97	2.46	3.07	7.50	2.8 ~ 8.0	2,170	580 ~ 2,760	10.7 / 9.8	1.3 + 1.5 + 1.7
	32 + 50 + 50	132	1.82	2.84	2.84	7.50	2.8 ~ 8.0	2,060	520 ~ 2,650	10.2 / 9.4	1.2 + 1.7 + 1.7
	40 + 40 + 40	120	2.50	2.50	2.50	7.50	2.8 ~ 8.0	2,170	590 ~ 2,820	10.7 / 9.8	1.5 + 1.5 + 1.5
	40 + 40 + 50	130	2.31	2.31	2.88	7.50	2.8 ~ 8.0	2,070	540 ~ 2,650	10.2 / 9.4	1.5 + 1.5 + 1.7

• Specification based on JIS C 9612 standard.
• A minimum of 2 indoor units must be connected.

INVERTER TRIPLE-SPLIT MODEL (CU-3S28SBH)

INDOOR UNIT COMBINATION	TOTAL	COOLING CAPACITY (kW)				POWER INPUT (W)			CURRENT (A) 220V / 240V	MOISTURE REMOVAL L/H	
		A	B	C	TOTAL	MIN - MAX	RATED	MIN - MAX			
1 Room	28	28	2.80		2.80	1.7 ~ 3.4	700	380 ~ 890	3.7 / 3.4	1.6	
	32	32	3.20		3.20	1.7 ~ 4.0	800	380 ~ 1,200	4.2 / 3.9	1.8	
	40	40	4.00		4.00	1.7 ~ 4.8	1,180	380 ~ 1,480	6.0 / 5.5	2.3	
	50	50	5.00		5.00	1.9 ~ 5.8	1,460	400 ~ 1,890	7.3 / 6.7	2.7	
2 Rooms	28 + 28	56	2.80	2.80	5.60	1.7 ~ 6.7	1,750	420 ~ 2,340	8.6 / 7.9	1.6 + 1.6	
	28 + 32	60	2.80	3.20	6.00	1.7 ~ 6.7	2,010	420 ~ 2,340	9.8 / 9.0	1.6 + 1.8	
	28 + 40	68	2.80	4.00	6.80	2.5 ~ 7.6	2,420	550 ~ 2,990	11.8 / 10.8	1.6 + 2.3	
	28 + 50	78	2.69	4.81	7.50	2.7 ~ 8.0	2,810	530 ~ 2,980	13.7 / 12.6	1.6 + 2.6	
	28 + 60	88	2.39	5.11	7.50	2.7 ~ 8.0	2,810	530 ~ 2,980	13.7 / 12.6	1.5 + 2.8	
	32 + 32	64	3.20	3.20	6.40	2.3 ~ 7.4	2,290	570 ~ 3,010	11.2 / 10.3	1.8 + 1.8	
	32 + 40	72	3.20	4.00	7.20	2.5 ~ 7.7	2,770	550 ~ 2,990	13.5 / 12.4	1.8 + 2.3	
	32 + 50	82	2.93	4.57	7.50	2.8 ~ 8.0	2,760	530 ~ 2,970	13.5 / 12.4	1.7 + 2.5	
	32 + 60	92	2.61	4.89	7.50	2.8 ~ 8.0	2,760	530 ~ 2,970	13.5 / 12.4	1.6 + 2.7	
	40 + 40	80	3.75	3.75	7.50	2.7 ~ 7.9	2,870	540 ~ 2,980	14.0 / 12.9	2.2 + 2.2	
	40 + 50	90	3.33	4.17	7.50	2.8 ~ 8.1	2,600	530 ~ 2,970	12.7 / 11.6	1.9 + 2.4	
	40 + 60	100	3.00	4.50	7.50	2.8 ~ 8.1	2,600	530 ~ 2,970	12.7 / 11.6	1.7 + 2.5	
	50 + 50	100	3.75	3.75	7.50	2.9 ~ 8.3	2,440	520 ~ 2,970	11.9 / 10.9	2.2 + 2.2	
	50 + 60	110	3.41	4.09	7.50	2.9 ~ 8.3	2,440	520 ~ 2,970	11.9 / 10.9	2.0 + 2.3	
	60 + 60	120	3.75	3.75	7.50	2.9 ~ 8.3	2,440	520 ~ 2,970	11.9 / 10.9	2.2 + 2.2	
	3 Rooms	28 + 28 + 28	84	2.50	2.50	2.50	7.50	2.4 ~ 7.9	2,740	580 ~ 2,840	13.4 / 12.3
28 + 28 + 32		88	2.39	2.39	2.72	7.50	2.4 ~ 8.0	2,690	580 ~ 2,850	13.1 / 12.1	1.5 + 1.5 + 1.6
28 + 28 + 40		96	2.19	2.19	3.12	7.50	2.6 ~ 8.4	2,490	600 ~ 2,930	12.2 / 11.2	1.4 + 1.4 + 1.8
28 + 28 + 50		106	1.98	1.98	3.54	7.50	2.8 ~ 8.8	2,250	600 ~ 3,010	11.0 / 10.1	1.3 + 1.3 + 2.0
28 + 28 + 60		116	1.81	1.81	3.88	7.50	2.8 ~ 8.8	2,250	600 ~ 3,010	11.0 / 10.1	1.2 + 1.2 + 2.3
28 + 32 + 32		92	2.28	2.61	2.61	7.50	2.4 ~ 8.0	2,690	580 ~ 2,860	13.1 / 12.1	1.5 + 1.6 + 1.6
28 + 32 + 40		100	2.10	2.40	3.00	7.50	2.6 ~ 8.4	2,450	600 ~ 2,930	12.0 / 11.0	1.4 + 1.5 + 1.7
28 + 32 + 50		110	1.91	2.18	3.41	7.50	2.8 ~ 8.8	2,250	600 ~ 3,020	11.0 / 10.1	1.2 + 1.4 + 2.0
28 + 32 + 60		120	1.75	2.00	3.75	7.50	2.8 ~ 8.8	2,250	600 ~ 3,020	11.0 / 10.1	1.1 + 1.3 + 2.2
28 + 40 + 40		108	1.94	2.78	2.78	7.50	2.7 ~ 8.7	2,290	600 ~ 3,000	11.2 / 10.3	1.3 + 1.6 + 1.6
28 + 40 + 50		118	1.78	2.54	3.18	7.50	2.8 ~ 9.0	2,170	580 ~ 3,050	10.6 / 9.7	1.1 + 1.6 + 1.8
28 + 40 + 60		128	1.64	2.34	3.52	7.50	2.8 ~ 9.0	2,170	580 ~ 3,050	10.6 / 9.7	1.0 + 1.5 + 2.0
28 + 50 + 50		128	1.64	2.93	2.93	7.50	2.8 ~ 9.0	2,070	520 ~ 2,830	10.1 / 9.3	1.0 + 1.7 + 1.7
32 + 32 + 32		96	2.50	2.50	2.50	7.50	2.4 ~ 8.0	2,650	590 ~ 2,860	13.0 / 11.9	1.5 + 1.5 + 1.5
32 + 32 + 40		104	2.31	2.31	2.88	7.50	2.6 ~ 8.4	2,450	600 ~ 2,940	12.0 / 11.0	1.5 + 1.5 + 1.7
32 + 32 + 50		114	2.11	2.11	3.28	7.50	2.8 ~ 8.8	2,250	600 ~ 3,020	11.0 / 10.1	1.4 + 1.4 + 1.9
32 + 32 + 60		124	1.94	1.94	3.62	7.50	2.8 ~ 8.8	2,250	600 ~ 3,020	11.0 / 10.1	1.3 + 1.3 + 2.1
32 + 40 + 40		112	2.14	2.68	2.68	7.50	2.8 ~ 8.7	2,290	600 ~ 3,000	11.2 / 10.3	1.4 + 1.6 + 1.6
32 + 40 + 50		122	1.97	2.46	3.07	7.50	2.8 ~ 9.0	2,170	580 ~ 3,060	10.6 / 9.7	1.3 + 1.5 + 1.7
32 + 40 + 60		132	1.82	2.27	3.41	7.50	2.8 ~ 9.0	2,170	580 ~ 3,060	10.6 / 9.7	1.2 + 1.5 + 2.0
32 + 50 + 50	132	1.82	2.84	2.84	7.50	2.8 ~ 9.0	2,060	520 ~ 2,830	10.1 / 9.2	1.2 + 1.7 + 1.7	
40 + 40 + 40	120	2.50	2.50	2.50	7.50	2.8 ~ 9.0	2,170	590 ~ 3,040	10.6 / 9.7	1.5 + 1.5 + 1.5	
40 + 40 + 50	130	2.31	2.31	2.88	7.50	2.8 ~ 9.0	2,070	540 ~ 2,830	10.1 / 9.3	1.5 + 1.5 + 1.7	

• Specification based on JIS C 9612 standard.
• A minimum of 2 indoor units must be connected.

INVERTER QUADRUPLE-SPLIT MODEL (CU-4S27SBH)

INDOOR UNIT COMBINATION	TOTAL	COOLING CAPACITY (kW)				TOTAL	MIN - MAX	POWER INPUT (W)		CURRENT (A) 220V/240V	MOISTURE REMOVAL L/H	
		A	B	C	D			RATED	MIN - MAX			
1 Room	28	28	2.800			2.80	1.7 ~ 3.4	700	380 ~ 890	3.8 / 3.5	1.6	
	32	32	3.200			3.20	1.7 ~ 4.0	800	380 ~ 1,200	4.3 / 3.9	1.8	
	40	40	4.000			4.00	1.7 ~ 4.8	1,180	380 ~ 1,480	6.1 / 5.6	2.3	
	50	50	5.000			5.00	1.9 ~ 5.8	1,460	400 ~ 1,890	7.4 / 6.8	2.7	
2 Rooms	28 + 28	56	2.800	2.800		5.60	1.7 ~ 6.4	1,750	420 ~ 2,600	8.7 / 8.0	1.6 + 1.6	
	28 + 32	60	2.800	3.200		6.00	1.7 ~ 6.5	2,010	420 ~ 2,600	10.0 / 9.2	1.6 + 1.8	
	28 + 40	68	2.800	4.000		6.80	2.5 ~ 7.3	2,420	550 ~ 3,330	12.0 / 11.0	1.6 + 2.3	
	28 + 50	78	2.690	4.810		7.50	2.7 ~ 7.7	2,810	530 ~ 3,310	13.9 / 12.7	1.6 + 2.6	
	32 + 32	64	3.200	3.200		6.40	2.3 ~ 7.1	2,290	570 ~ 3,350	11.3 / 10.4	1.8 + 1.8	
	32 + 40	72	3.200	4.000		7.20	2.5 ~ 7.4	2,770	550 ~ 3,330	13.7 / 12.5	1.8 + 2.3	
	32 + 50	82	2.930	4.570		7.50	2.8 ~ 7.7	2,760	530 ~ 3,310	13.6 / 12.5	1.7 + 2.5	
	40 + 40	80	3.750	3.750		7.50	2.7 ~ 7.6	2,870	540 ~ 3,310	14.2 / 13.0	2.2 + 2.2	
	40 + 50	90	3.330	4.170		7.50	2.8 ~ 7.8	2,600	530 ~ 3,300	12.8 / 11.8	1.9 + 2.4	
3 Rooms	28 + 28 + 28	84	2.500	2.500	2.500	7.50	2.4 ~ 7.6	2,740	580 ~ 3,170	13.5 / 12.4	1.5 + 1.5 + 1.5	
	28 + 28 + 32	88	2.390	2.390	2.720	7.50	2.4 ~ 7.7	2,690	580 ~ 3,170	13.3 / 12.2	1.5 + 1.5 + 1.6	
	28 + 28 + 40	96	2.190	2.190	3.120	7.50	2.6 ~ 8.0	2,490	600 ~ 3,260	12.3 / 11.3	1.4 + 1.4 + 1.8	
	28 + 28 + 50	106	1.980	1.980	3.540	7.50	2.8 ~ 8.0	2,250	600 ~ 2,910	11.1 / 10.2	1.3 + 1.3 + 2.0	
	28 + 32 + 32	92	2.280	2.610	2.610	7.50	2.4 ~ 7.7	2,690	580 ~ 3,180	13.3 / 12.2	1.5 + 1.6 + 1.6	
	28 + 32 + 40	100	2.100	2.400	3.000	7.50	2.6 ~ 8.0	2,450	600 ~ 3,200	12.1 / 11.1	1.4 + 1.5 + 1.7	
	28 + 32 + 50	110	1.910	2.180	3.410	7.50	2.8 ~ 8.0	2,250	600 ~ 2,910	11.1 / 10.2	1.2 + 1.4 + 2.0	
	28 + 40 + 40	108	1.940	2.780	2.780	7.50	2.7 ~ 8.0	2,290	600 ~ 3,020	11.3 / 10.4	1.3 + 1.6 + 1.6	
	28 + 40 + 50	118	1.780	2.540	3.180	7.50	2.8 ~ 8.0	2,170	580 ~ 2,760	10.7 / 9.8	1.1 + 1.6 + 1.8	
	28 + 50 + 50	128	1.640	2.930	2.930	7.50	2.8 ~ 8.0	2,070	520 ~ 2,650	10.2 / 9.4	1.0 + 1.7 + 1.7	
	32 + 32 + 32	96	2.500	2.500	2.500	7.50	2.4 ~ 7.7	2,650	590 ~ 3,190	13.1 / 12.0	1.5 + 1.5 + 1.5	
	32 + 32 + 40	104	2.310	2.310	2.880	7.50	2.6 ~ 8.0	2,450	600 ~ 3,210	12.1 / 11.1	1.5 + 1.5 + 1.7	
	32 + 32 + 50	114	2.110	2.110	3.280	7.50	2.8 ~ 8.0	2,250	600 ~ 2,920	11.1 / 10.2	1.4 + 1.4 + 1.9	
	32 + 40 + 40	112	2.140	2.680	2.680	7.50	2.8 ~ 8.0	2,290	600 ~ 2,960	11.3 / 10.4	1.4 + 1.6 + 1.6	
	32 + 40 + 50	122	1.970	2.460	3.070	7.50	2.8 ~ 8.0	2,170	580 ~ 2,760	10.7 / 9.8	1.3 + 1.5 + 1.7	
	32 + 50 + 50	132	1.820	2.840	2.840	7.50	2.8 ~ 8.0	2,060	520 ~ 2,650	10.2 / 9.4	1.2 + 1.7 + 1.7	
	40 + 40 + 40	120	2.500	2.500	2.500	7.50	2.8 ~ 8.0	2,170	590 ~ 2,820	10.7 / 9.8	1.5 + 1.5 + 1.5	
40 + 40 + 50	130	2.310	2.310	2.880	7.50	2.8 ~ 8.0	2,070	540 ~ 2,650	10.2 / 9.4	1.5 + 1.5 + 1.7		
4 Rooms	28 + 28 + 28 + 28	112	1.875	1.875	1.875	1.875	7.50	2.8 ~ 8.0	2,060	520 ~ 2,650	10.2 / 9.4	1.2 + 1.2 + 1.2 + 1.2
	28 + 28 + 28 + 32	116	1.810	1.810	1.810	2.070	7.50	2.8 ~ 8.0	2,060	520 ~ 2,650	10.2 / 9.4	1.2 + 1.2 + 1.2 + 1.3
	28 + 28 + 28 + 40	124	1.690	1.690	1.690	2.430	7.50	2.8 ~ 8.0	2,060	520 ~ 2,590	10.2 / 9.4	1.1 + 1.1 + 1.1 + 1.5
	28 + 28 + 28 + 50	134	1.570	1.570	1.570	2.790	7.50	2.8 ~ 8.0	2,060	520 ~ 2,530	10.2 / 9.4	1.0 + 1.0 + 1.0 + 1.6
	28 + 28 + 32 + 32	120	1.750	1.750	2.000	2.000	7.50	2.8 ~ 8.0	2,060	520 ~ 2,650	10.2 / 9.4	1.1 + 1.1 + 1.3 + 1.3
	28 + 28 + 32 + 40	128	1.640	1.640	1.880	2.340	7.50	2.8 ~ 8.0	2,060	520 ~ 2,590	10.2 / 9.4	1.0 + 1.0 + 1.2 + 1.5
	28 + 32 + 32 + 32	124	1.680	1.940	1.940	1.940	7.50	2.8 ~ 8.0	2,060	520 ~ 2,650	10.2 / 9.4	1.1 + 1.3 + 1.3 + 1.3
	28 + 32 + 32 + 40	132	1.590	1.820	1.820	2.270	7.50	2.8 ~ 8.0	2,060	520 ~ 2,590	10.2 / 9.4	1.0 + 1.2 + 1.2 + 1.5
	32 + 32 + 32 + 32	128	1.875	1.875	1.875	1.875	7.50	2.8 ~ 8.0	2,060	520 ~ 2,590	10.2 / 9.4	1.2 + 1.2 + 1.2 + 1.2

- Specification based on JIS C 9612 standard.
- A minimum of 2 indoor units must be connected.

INVERTER QUADRUPLE-SPLIT MODEL (CU-4S34SBH)













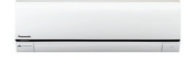

INDOOR UNIT COMBINATION	TOTAL	COOLING CAPACITY (kW)				TOTAL	MIN - MAX	POWER INPUT (W)		CURRENT (A) 220V/240V	MOISTURE REMOVAL L/H
		A	B	C	D			RATED	MIN - MAX		
1 Room	28	28	2.80			2.80	1.7 ~ 3.4	700	380 ~ 890	3.6 / 3.3	1.6
	32	32	3.20			3.20	1.7 ~ 4.0	800	380 ~ 1,200	4.1 / 3.8	1.8
	40	40	4.00			4.00	1.7 ~ 4.8	1,240	380 ~ 1,480	6.0 / 5.5	2.3
	50	50	5.00			5.00	1.9 ~ 5.8	1,550	400 ~ 1,890	7.5 / 6.9	2.7
	60	60	6.00			6.00	1.9 ~ 6.2	2,030	400 ~ 2,070	9.6 / 8.8	3.3
2 Rooms	28 + 28	56	2.80	2.80		5.60	2.4 ~ 5.8	1,740	300 ~ 1,860	8.5 / 7.8	1.6 + 1.6
	28 + 32	60	2.80	3.20		6.00	2.4 ~ 6.7	1,920	300 ~ 2,360	9.3 / 8.5	1.6 + 1.8
	28 + 40	68	2.80	4.00		6.80	2.4 ~ 7.2	2,420	300 ~ 2,760	11.7 / 10.7	1.6 + 2.3
	28 + 50	78	2.80	5.00		7.80	2.4 ~ 8.6	2,680	280 ~ 3,330	12.9 / 11.8	1.6 + 2.7
	28 + 60	88	2.80	6.00		8.80	2.5 ~ 9.1	3,450	310 ~ 3,640	16.6 / 15.2	1.6 + 3.3
	28 + 70	98	2.80	7.00		9.80	2.5 ~ 10.1	4,140	310 ~ 4,620	20.0 / 18.3	1.6 + 4.0
	32 + 32	64	3.20	3.20		6.40	2.4 ~ 7.2	2,100	290 ~ 2,620	10.1 / 9.3	1.8 + 1.8
	32 + 40	72	3.20	4.00		7.20	2.4 ~ 8.1	2,620	290 ~ 3,390	12.6 / 11.6	1.8 + 2.3
	32 + 50	82	3.20	5.00		8.20	2.5 ~ 9.1	2,890	310 ~ 3,490	13.9 / 12.8	1.8 + 2.7
	32 + 60	92	3.20	6.00		9.20	2.5 ~ 10.0	3,570	310 ~ 4,460	17.2 / 15.8	1.8 + 3.3
	32 + 70	102	3.14	6.86		10.00	2.5 ~ 10.4	4,220	310 ~ 4,800	20.3 / 18.6	1.8 + 3.9
	40 + 40	80	4.00	4.00		8.00	2.5 ~ 8.6	3,240	320 ~ 3,930	15.6 / 14.3	2.3 + 2.3
	40 + 50	90	4.00	5.00		9.00	2.5 ~ 10.0	3,460	310 ~ 4,460	16.7 / 15.3	2.3 + 2.7
	40 + 60	100	4.00	6.00		10.00	2.5 ~ 10.4	4,460	310 ~ 4,790	21.5 / 19.7	2.3 + 3.3
	40 + 70	110	3.64	6.36		10.00	2.5 ~ 10.4	4,150	310 ~ 4,800	20.0 / 18.3	2.1 + 3.6
	50 + 50	100	5.00	5.00		10.00	2.5 ~ 10.4	3,610	300 ~ 4,000	17.4 / 16.0	2.7 + 2.7
	50 + 60	110	4.55	5.45		10.00	2.5 ~ 10.4	3,610	300 ~ 4,000	17.4 / 16.0	2.5 + 2.9
50 + 70	120	4.17	5.83		10.00	2.5 ~ 10.4	3,470	300 ~ 3,850	16.7 / 15.3	2.4 + 3.2	
60 + 60	120	5.00	5.00		10.00	2.5 ~ 10.4	3,610	300 ~ 4,000	17.4 / 16.0	2.7 + 2.7	
60 + 70	130	4.62	5.38		10.00	2.5 ~ 10.4	3,470	300 ~ 3,850	16.7 / 15.3	2.5 + 2.9	
70 + 70	140	5.00	5.00		10.00	2.5 ~ 10.4	3,320	330 ~ 3,690	16.0 / 14.7	2.7 + 2.7	
3 Rooms	28 + 28 + 28	84	2.80	2.80	2.80	8.40	2.9 ~ 8.7	2,750	360 ~ 2,880	13.3 / 12.2	1.6 + 1.6 + 1.6
	28 + 28 + 32	88	2.80	2.80	3.20	8.80	2.9 ~ 9.6	2,880	390 ~ 3,320	13.9 / 12.7	1.6 + 1.6 + 1.8
	28 + 28 + 40	96	2.80	2.80	4.00	9.60	2.9 ~ 10.1	3,320	390 ~ 3,770	16.0 / 14.7	1.6 + 1.6 + 2.3
	28 + 28 + 50	106	2.64	2.64	4.72	10.00	2.9 ~ 10.7	3,180	390 ~ 3,770	15.3 / 14.1	1.6 + 1.6 + 2.5
	28 + 28 + 60	116	2.41	2.41	5.18	10.00	2.9 ~ 10.7	3,180	390 ~ 3,770	15.3 / 14.1	1.5 + 1.5 + 2.9
	28 + 28 + 70	126	2.22	2.22	5.56	10.00	2.9 ~ 10.7	3,110	390 ~ 3,620	15.0 / 13.7	1.4 + 1.4 + 3.0
	28 + 32 + 32	92	2.80	3.20	3.20	9.20	2.9 ~ 10.1	2,990	390 ~ 3,690	14.4 / 13.2	1.6 + 1.8 + 1.8
	28 + 32 + 40	100	2.80	3.20	4.00	10.00	2.9 ~ 10.7	3,540	390 ~ 4,320	17.1 / 15.6	1.6 + 1.8 + 2.3
	28 + 32 + 50	110	2.54	2.91	4.55	10.00	2.9 ~ 10.7	3,110	390 ~ 3,700	15.0 / 13.7	1.6 + 1.7 + 2.5
	28 + 32 + 60	120	2.33	2.67	5.00	10.00	2.9 ~ 10.7	3,110	390 ~ 3,700	15.0 / 13.7	1.5 + 1.6 + 2.7
	28 + 32 + 70	130	2.15	2.46	5.39	10.00	2.9 ~ 10.7	3,040	420 ~ 3,540	14.7 / 13.4	1.4 + 1.5 + 2.9
	28 + 40 + 40	108	2.60	3.70	3.70	10.00	2.9 ~ 10.7	3,540	390 ~ 4,320	17.1 / 15.6	1.6 + 2.2 + 2.2
	28 + 40 + 50	118	2.37	3.39	4.24	10.00	2.9 ~ 10.7	3,110	390 ~ 3,620	15.0 / 13.7	1.5 + 1.9 + 2.4
	28 + 40 + 60	128	2.18	3.13	4.69	10.00	2.9 ~ 10.7	3,110	390 ~ 3,620	15.0 / 13.7	1.4 + 1.8 + 2.5
	28 + 40 + 70	138	2.03	2.90	5.07	10.00	2.9 ~ 10.7	2,970	420 ~ 3,540	14.3 / 13.1	1.3 + 1.7 + 2.8
	28 + 50 + 50	128	2								

INVERTER QUADRUPLE-SPLIT MODEL (CU-4S34SBH)

INDOOR UNIT COMBINATION	TOTAL	COOLING CAPACITY (kW)				TOTAL		POWER INPUT (W)		CURRENT (A)		MOISTURE REMOVAL (L/H)
		A	B	C	D	MIN - MAX	RATED	MIN - MAX	220V / 240V			
3 Rooms	32 + 70 + 70	172	1.86	4.07	4.07		10.00	2.9 ~ 10.7	2,700	470 ~ 3,110	13.0 / 11.9	1.2 + 2.3 + 2.3
	40 + 40 + 40	120	3.33	3.33	3.33		9.99	2.9 ~ 10.7	3,390	390 ~ 4,080	16.3 / 15.0	1.9 + 1.9 + 1.9
	40 + 40 + 50	130	3.08	3.08	3.84		10.00	2.9 ~ 10.7	2,970	420 ~ 3,540	14.3 / 13.1	1.7 + 1.7 + 2.2
	40 + 40 + 60	140	2.86	2.86	4.28		10.00	2.9 ~ 10.7	2,970	420 ~ 3,540	14.3 / 13.1	1.7 + 1.7 + 2.4
	40 + 40 + 70	150	2.67	2.67	4.66		10.00	2.9 ~ 10.7	2,900	420 ~ 3,400	14.0 / 12.8	1.6 + 1.6 + 2.5
	40 + 50 + 50	140	2.86	3.57	3.57		10.00	2.9 ~ 10.7	2,760	460 ~ 3,180	13.3 / 12.2	1.7 + 2.1 + 2.1
	40 + 50 + 60	150	2.67	3.33	4.00		10.00	2.9 ~ 10.7	2,760	460 ~ 3,180	13.3 / 12.2	1.6 + 1.9 + 2.3
	40 + 50 + 70	160	2.49	3.13	4.38		10.00	2.9 ~ 10.7	2,690	460 ~ 3,110	13.0 / 11.9	1.5 + 1.8 + 2.4
	40 + 60 + 60	160	2.50	3.75	3.75		10.00	2.9 ~ 10.7	2,760	460 ~ 3,180	13.3 / 12.2	1.5 + 2.2 + 2.2
	40 + 60 + 70	170	2.35	3.53	4.12		10.00	2.9 ~ 10.7	2,690	460 ~ 3,110	13.0 / 11.9	1.5 + 2.0 + 2.3
	50 + 50 + 50	150	3.33	3.33	3.33		9.99	2.9 ~ 10.7	2,570	510 ~ 2,970	12.4 / 11.4	1.9 + 1.9 + 1.9
	50 + 50 + 60	160	3.13	3.13	3.74		10.00	2.9 ~ 10.7	2,630	510 ~ 2,970	12.7 / 11.6	1.8 + 1.8 + 2.2
	50 + 50 + 70	170	2.94	2.94	4.12		10.00	2.9 ~ 10.7	2,570	510 ~ 2,970	12.4 / 11.4	1.7 + 1.7 + 2.3
	50 + 60 + 60	170	2.94	3.53	3.53		10.00	2.9 ~ 10.7	2,630	510 ~ 2,970	12.7 / 11.6	1.7 + 2.0 + 2.0
4 Rooms	28 + 28 + 28 + 28	112	2.50	2.50	2.50	2.50	10.00	2.9 ~ 10.6	3,220	420 ~ 3,770	15.5 / 14.2	1.5 + 1.5 + 1.5 + 1.5
	28 + 28 + 28 + 32	116	2.41	2.41	2.41	2.77	10.00	2.9 ~ 10.6	3,150	420 ~ 3,680	15.2 / 13.9	1.5 + 1.5 + 1.5 + 1.6
	28 + 28 + 28 + 40	124	2.26	2.26	2.26	3.22	10.00	2.9 ~ 10.8	3,150	430 ~ 3,850	15.2 / 13.9	1.5 + 1.5 + 1.5 + 1.8
	28 + 28 + 28 + 50	134	2.09	2.09	2.09	3.73	10.00	2.9 ~ 10.8	2,930	470 ~ 3,520	14.1 / 12.9	1.4 + 1.4 + 1.4 + 2.2
	28 + 28 + 28 + 60	144	1.94	1.94	1.94	4.18	10.00	2.9 ~ 11.0	2,930	470 ~ 3,690	14.1 / 12.9	1.3 + 1.3 + 1.3 + 2.4
	28 + 28 + 28 + 70	154	1.82	1.82	1.82	4.54	10.00	2.9 ~ 11.0	2,930	500 ~ 3,610	14.1 / 12.9	1.2 + 1.2 + 1.2 + 2.5
	28 + 28 + 32 + 32	120	2.33	2.33	2.67	2.67	10.00	2.9 ~ 10.6	3,070	430 ~ 3,600	14.8 / 13.6	1.5 + 1.5 + 1.6 + 1.6
	28 + 28 + 32 + 40	128	2.19	2.19	2.49	3.13	10.00	2.9 ~ 10.8	3,070	430 ~ 3,770	14.8 / 13.6	1.4 + 1.4 + 1.5 + 1.8
	28 + 28 + 32 + 50	138	2.03	2.03	2.32	3.62	10.00	2.9 ~ 10.8	2,930	500 ~ 3,440	14.1 / 12.9	1.3 + 1.3 + 1.5 + 2.1
	28 + 28 + 32 + 60	148	1.89	1.89	2.16	4.06	10.00	2.9 ~ 11.0	2,930	500 ~ 3,610	14.1 / 12.9	1.2 + 1.2 + 1.4 + 2.3
	28 + 28 + 32 + 70	158	1.77	1.77	2.03	4.43	10.00	2.9 ~ 11.2	2,860	510 ~ 3,690	13.8 / 12.6	1.1 + 1.1 + 1.3 + 2.5
	28 + 28 + 40 + 40	136	2.06	2.06	2.94	2.94	10.00	2.9 ~ 10.8	3,070	430 ~ 3,770	14.8 / 13.6	1.3 + 1.3 + 1.7 + 1.7
	28 + 28 + 40 + 50	146	1.92	1.92	2.74	3.42	10.00	2.9 ~ 11.0	2,930	500 ~ 3,610	14.1 / 12.9	1.2 + 1.2 + 1.6 + 2.0
	28 + 28 + 40 + 60	156	1.79	1.79	2.56	3.86	10.00	2.9 ~ 11.0	2,930	500 ~ 3,610	14.1 / 12.9	1.2 + 1.2 + 1.6 + 2.3
	28 + 28 + 40 + 70	166	1.69	1.69	2.40	4.22	10.00	2.9 ~ 11.2	2,860	510 ~ 3,690	13.8 / 12.6	1.1 + 1.1 + 1.5 + 2.4
	28 + 28 + 50 + 50	156	1.79	1.79	3.21	3.21	10.00	2.9 ~ 11.0	2,800	560 ~ 3,460	13.5 / 12.4	1.2 + 1.2 + 1.8 + 1.8
	28 + 28 + 50 + 60	166	1.69	1.69	3.01	3.61	10.00	2.9 ~ 11.2	2,800	560 ~ 3,540	13.5 / 12.4	1.1 + 1.1 + 1.7 + 2.1
	28 + 32 + 32 + 32	124	2.26	2.58	2.58	2.58	10.00	2.9 ~ 10.8	3,070	460 ~ 3,680	14.8 / 13.6	1.5 + 1.6 + 1.6 + 1.6
	28 + 32 + 32 + 40	132	2.12	2.42	2.42	3.04	10.00	2.9 ~ 10.8	3,070	460 ~ 3,680	14.8 / 13.6	1.4 + 1.5 + 1.5 + 1.7
	28 + 32 + 32 + 50	142	1.97	2.25	2.25	3.53	10.00	2.9 ~ 11.0	2,860	510 ~ 3,610	13.8 / 12.6	1.3 + 1.5 + 1.5 + 2.0
	28 + 32 + 32 + 60	152	1.83	2.11	2.11	3.95	10.00	2.9 ~ 11.0	2,860	510 ~ 3,610	13.8 / 12.6	1.2 + 1.4 + 1.4 + 2.3
	28 + 32 + 32 + 70	162	1.72	1.98	1.98	4.32	10.00	2.9 ~ 11.2	2,860	510 ~ 3,690	13.8 / 12.6	1.1 + 1.3 + 1.3 + 2.4
	28 + 32 + 40 + 40	140	1.99	2.29	2.86	2.86	10.00	2.9 ~ 10.8	3,070	460 ~ 3,680	14.8 / 13.6	1.3 + 1.5 + 1.7 + 1.7
	28 + 32 + 40 + 50	150	1.87	2.13	2.67	3.33	10.00	2.9 ~ 11.0	2,860	510 ~ 3,530	13.8 / 12.6	1.2 + 1.4 + 1.6 + 1.9
	28 + 32 + 40 + 60	160	1.75	2.00	2.50	3.75	10.00	2.9 ~ 11.2	2,860	510 ~ 3,690	13.8 / 12.6	1.1 + 1.3 + 1.5 + 2.2
	28 + 32 + 40 + 70	170	1.65	1.88	2.35	4.12	10.00	2.9 ~ 11.2	2,860	510 ~ 3,690	13.8 / 12.6	1.1 + 1.2 + 1.5 + 2.3
	28 + 32 + 50 + 50	160	1.74	2.00	3.13	3.13	10.00	2.9 ~ 11.2	2,800	560 ~ 3,540	13.5 / 12.4	1.1 + 1.3 + 1.8 + 1.8
	28 + 32 + 50 + 60	170	1.65	1.88	2.94	3.53	10.00	2.9 ~ 11.2	2,800	560 ~ 3,540	13.5 / 12.4	1.1 + 1.2 + 1.7 + 2.0
	28 + 40 + 40 + 40	148	1.90	2.70	2.70	2.70	10.00	2.9 ~ 11.0	3,000	460 ~ 3,770	14.5 / 13.3	1.2 + 1.6 + 1.6 + 1.6
	28 + 40 + 40 + 50	158	1.77	2.53	2.53	3.17	10.00	2.9 ~ 11.2	2,860	510 ~ 3,690	13.8 / 12.6	1.1 + 1.6 + 1.6 + 1.8
	28 + 40 + 40 + 60	168	1.67	2.38	2.38	3.57	10.00	2.9 ~ 11.2	2,860	510 ~ 3,690	13.8 / 12.6	1.1 + 1.5 + 1.5 + 2.1
	28 + 40 + 50 + 50	168	1.66	2.38	2.98	2.98	10.00	2.9 ~ 11.2	2,800	560 ~ 3,540	13.5 / 12.4	1.1 + 1.5 + 1.7 + 1.7
	32 + 32 + 32 + 32	128	2.50	2.50	2.50	2.50	10.00	2.9 ~ 10.8	3,000	460 ~ 3,600	14.5 / 13.3	1.5 + 1.5 + 1.5 + 1.5
	32 + 32 + 32 + 40	136	2.35	2.35	2.35	2.95	10.00	2.9 ~ 10.8	3,000	460 ~ 3,600	14.5 / 13.3	1.5 + 1.5 + 1.5 + 1.7
	32 + 32 + 32 + 50	146	2.19	2.19	2.19	3.43	10.00	2.9 ~ 11.0	2,860	510 ~ 3,530	13.8 / 12.6	1.4 + 1.4 + 1.4 + 2.0
	32 + 32 + 32 + 60	156	2.05	2.05	2.05	3.85	10.00	2.9 ~ 11.0	2,860	510 ~ 3,530	13.8 / 12.6	1.3 + 1.3 + 1.3 + 2.3
32 + 32 + 32 + 70	166	1.93	1.93	1.93	4.21	10.00	2.9 ~ 11.2	2,860	520 ~ 3,610	13.8 / 12.6	1.2 + 1.2 + 1.2 + 2.4	
32 + 32 + 40 + 40	144	2.22	2.22	2.78	2.78	10.00	2.9 ~ 11.0	3,000	460 ~ 3,770	14.5 / 13.3	1.4 + 1.4 + 1.6 + 1.6	
32 + 32 + 40 + 50	154	2.08	2.08	2.59	3.25	10.00	2.9 ~ 11.0	2,860	510 ~ 3,530	13.8 / 12.6	1.3 + 1.3 + 1.6 + 1.8	
32 + 32 + 40 + 60	164	1.95	1.95	2.44	3.66	10.00	2.9 ~ 11.2	2,860	510 ~ 3,690	13.8 / 12.6	1.3 + 1.3 + 1.5 + 2.1	
32 + 32 + 40 + 70	174	1.84	1.84	2.30	4.02	10.00	2.9 ~ 11.2	2,860	550 ~ 3,610	13.8 / 12.6	1.2 + 1.2 + 1.5 + 2.3	
32 + 32 + 50 + 50	164	1.95	1.95	3.05	3.05	10.00	2.9 ~ 11.2	2,800	600 ~ 3,540	13.5 / 12.4	1.3 + 1.3 + 1.7 + 1.7	
32 + 32 + 50 + 60	174	1.84	1.84	2.87	3.45	10.00	2.9 ~ 11.2	2,800	600 ~ 3,540	13.5 / 12.4	1.2 + 1.2 + 1.7 + 2.0	
32 + 40 + 40 + 40	152	2.11	2.63	2.63	2.63	10.00	2.9 ~ 11.0	3,000	460 ~ 3,770	14.5 / 13.3	1.4 + 1.6 + 1.6 + 1.6	
32 + 40 + 40 + 50	162	1.97	2.47	2.47	3.09	10.00	2.9 ~ 11.2	2,860	510 ~ 3,690	13.8 / 12.6	1.3 + 1.5 + 1.5 + 1.7	
32 + 40 + 40 + 60	172	1.85	2.33	2.33	3.49	10.00	2.9 ~ 11.2	2,860	510 ~ 3,690	13.8 / 12.6	1.2 + 1.5 + 1.5 + 2.0	
32 + 40 + 50 + 50	172	1.85	2.33	2.91	2.91	10.00	2.9 ~ 11.2	2,810	600 ~ 3,540	13.5 / 12.4	1.2 + 1.5 + 1.7 + 1.7	
40 + 40 + 40 + 40	160	2.50	2.50	2.50	2.50	10.00	2.9 ~ 11.2	3,000	470 ~ 3,850	14.5 / 13.3	1.5 + 1.5 + 1.5 + 1.5	
40 + 40 + 40 + 50	170	2.35	2.35	2.35	2.95	10.00	2.9 ~ 11.2	2,860	520 ~ 3,610	13.8 / 12.6	1.5 + 1.5 + 1.5 + 1.7	

• Specification based on JIS C 9612 standard.
• A minimum of 2 indoor units must be connected.

Connection of Cooling Multi Inverter



Outdoor Unit	Type	Indoor	
		Maximum Connectable Indoor unit kW	kW
 CU-2S18SKH	Wall Mounted 	6.4	2.8 3.2
	Slim Duct 		2.8 3.2
 CU-3S27SBH	Wall Mounted 	13.2	2.8 3.2 4.0 5.0
	Slim Duct 		2.8 3.2 5.0
 CU-4S27SBH	Wall Mounted 	13.4	2.8 3.2 4.0 5.0
	Slim Duct 		2.8 3.2 5.0
 CU-3S28SBH	Wall Mounted 	13.2	2.8 3.2 4.0 5.0 6.0
	Slim Duct 		2.8 3.2 5.0 6.0
 CU-4S34SBH	Wall Mounted 	17.4	2.8 3.2 4.0 5.0 6.0 7.0
	Slim Duct 		2.8 3.2 5.0 6.0

Pipe size expander CZ-MA2P must be used(OD connect to 1/2" piping).





















FEATURES COMPARISON

Split Type	Inverter Multi-Split		
	Wall-Mounted		Slim Ducted
Cooling Models	CS-MPS9SKH CS-MPS12SKH CS-MPS15SKH	CS-MPS18SKH CS-MPS24SKH CS-MPS28SKH	CS-MS9SD3H CS-MS12SD3H CS-MS18SD3H CS-MS24SD3H
COMFORT			
Inverter Control	●	●	●
Quiet Mode	●	●	●
Powerful Mode	●	●	●
Soft Dry Operation Mode	●	●	●
Personal Airflow Creation	●	●	●
Airflow Direction Control (Up & Down)	●	●	●
Manual Horizontal Airflow Direction Control	●	●	●
Automatic Operation Mode (Cooling)	●	●	●
CLEANER AIR			
Anti-Bacterial Filter	●	●	●
Odour-Removing Function	●	●	●
Removable, Washable Panel	●	●	●
CONVENIENCE			
24-Hour Dual ON & OFF Real Setting Timer	●	●	●
24-Hour ON & OFF Real Setting Timer	●	●	●
LCD Wireless Remote Control	●	●	●
Wired Remote Control	(Optional)	(Optional)	(Optional)
RELIABILITY			
Random Auto Restart (32 Restart Patterns)	●	●	●
Blue Fin Condenser	●	●	●
Long Piping (Numbers indicate the maximum pipe length)	**refer page 6	**refer page 6	**refer page 6
Top-Panel Maintenance Access	●	●	●
Self-Diagnostic Function	●	●	●

OPTIONAL ACCESSORIES

PIPE SIZE EXPANDER	RAC INTERFACE ADAPTOR	REMOTE CONTROL
Use at the outdoor unit's connection port		Wired Remote Control
		
CZ-MA2P	CZ-CAPRA1	CZ-RD514C
CS-MPS24SKH, CS-MPS28SKH	CS-MPS9SKH, CS-MPS12SKH, CS-MPS15SKH, CS-MPS18SKH, CS-MPS24SKH, CS-MPS28SKH, CS-MS9SD3H, CS-MS12SD3H, CS-MS18SD3H, CS-MS24SD3H	CS-MPS9SKH, MPS12SKH, CS-MPS15SKH, CS-MPS18SKH, CS-MPS24SKH, CS-MPS28SKH

FEATURES EXPLANATION

COMFORT	
INVERTER CONTROL Varies the rotation speed of the compressor for higher energy savings.	
QUIET MODE	
POWERFUL MODE	
SOFT DRY OPERATION MODE Starts with cooling to dehumidify, then provides continuous breeze at a low frequency to keep a room dry without much change to the temperature.	
PERSONAL AIRFLOW CREATION Vertical and horizontal airflow patterns can be combined as desired to achieve optimum comfort, with operation possible by remote even from a distance.	
AIRFLOW DIRECTION CONTROL (UP & DOWN)	
MANUAL HORIZONTAL AIRFLOW DIRECTION CONTROL	
AUTOMATIC OPERATION MODE (COOLING)	
CLEANER AIR	
ANTI-BACTERIAL FILTER The Anti-Bacterial Filter combines three effects in one: anti-allergen, anti-virus and anti-bacteria protection to provide clean air.	
ODOUR-REMOVING FUNCTION With this function, there's no unpleasant odor when the unit starts up. That's because the fan remains off momentarily, while the source of the odour inside the air conditioner is suppressed. The unit must be in cool or dry mode and the fan speed must be set to automatic.	
REMOVABLE, WASHABLE PANEL	
CONVENIENCE	
24-HOUR DUAL ON & OFF REAL SETTING TIMER This feature enables you to preset two different sets of start/stop operation timer (hour and minute) within a 24-hour time frame.	
24-HOUR ON & OFF REAL SETTING TIMER The exact operating time (hour and minute) of the air conditioner can be set in advance. From here on, the unit will operate in accordance to these preset hours every day until the system is reset.	
LCD WIRELESS REMOTE CONTROL	
WIRED REMOTE CONTROL	
RELIABILITY	
RANDOM AUTO RESTART	
BLUE FIN CONDENSER	
LONG PIPING	
TOP-PANEL MAINTENANCE ACCESS	
SELF-DIAGNOSTIC FUNCTION Should a malfunction occur, the unit diagnoses the problem and shows the corresponding alphanumeric code. This allows for quicker servicing.	

RAC INTERFACE ADAPTOR

SPECIFICATIONS

RAC Interface Adaptor
This adaptor serves as an interface required to connect a central control device such as an intelligent controller with a room air conditioner. Using this adaptor can operate or monitor the room air conditioner from the the central control device. Panasonic room air conditioners equipped with the CN-CNT terminal are supported.

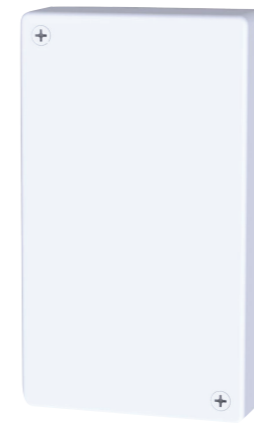

DIMENSIONS

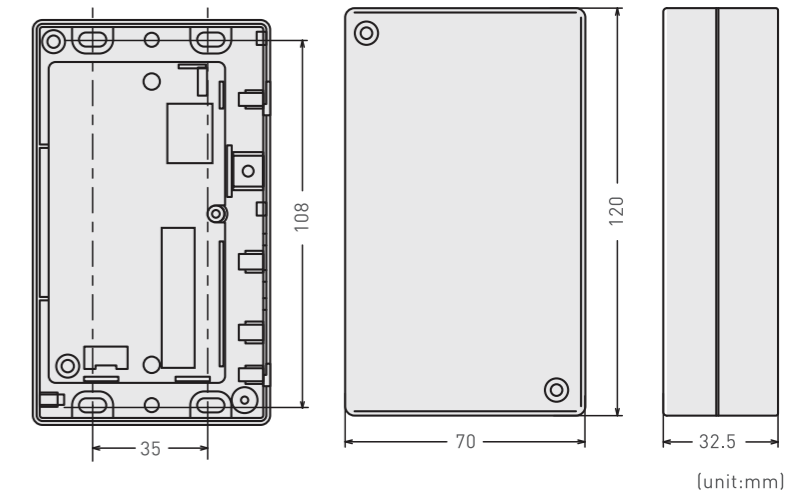

Model No.	CZ-CAPRA1
Dimensions (mm)	(H) 120 x (W) 70 x (D) 32.5
Weight	130 g
Power Source	DC12 V (Supplied with room air conditioner) (Connection wiring (1.9m) supplied with adaptor.)

RAC INTERFACE ADAPTOR CONNECTION

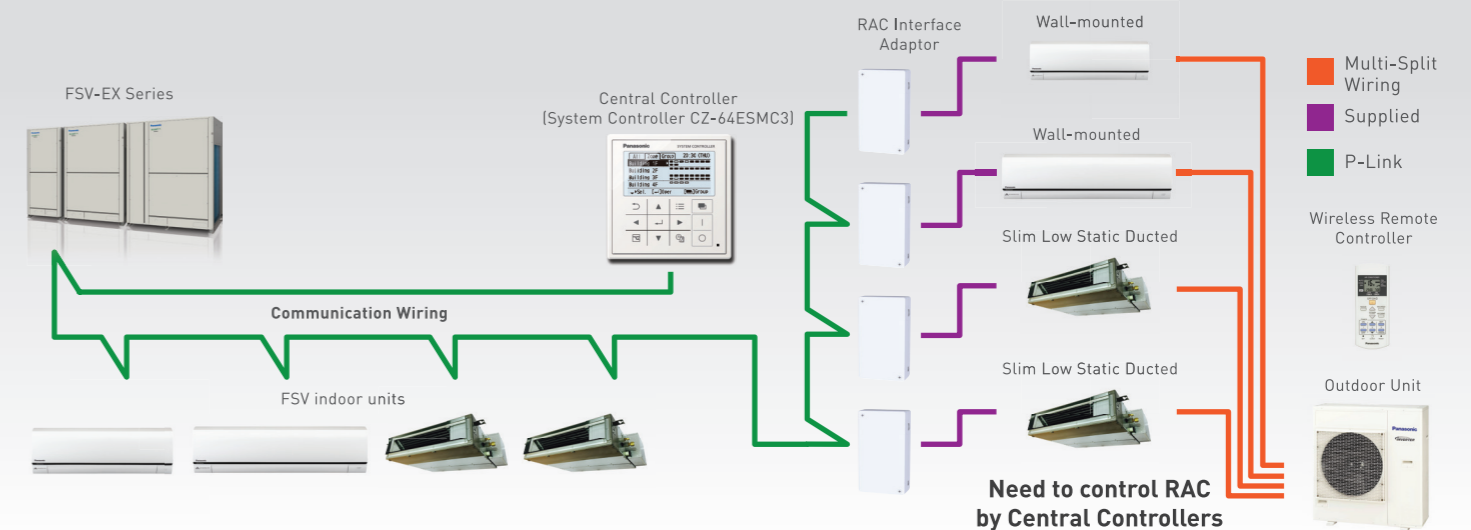

INDOOR DIMENSIONS / WALL-MOUNTED

CS-MPS9SKH / CS-MPS12SKH / CS-MPS15SKH

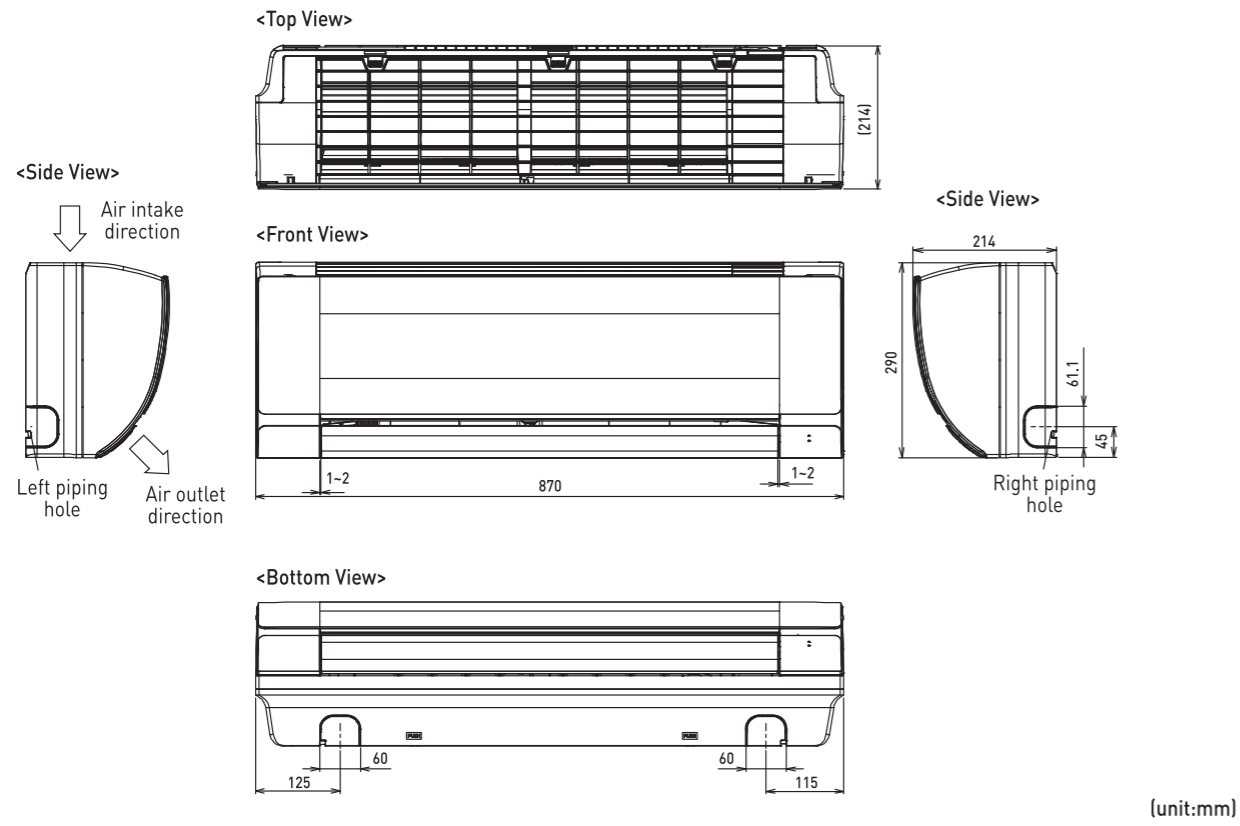

CS-MPS18SKH / CS-MPS24SKH / CS-MPS28SKH

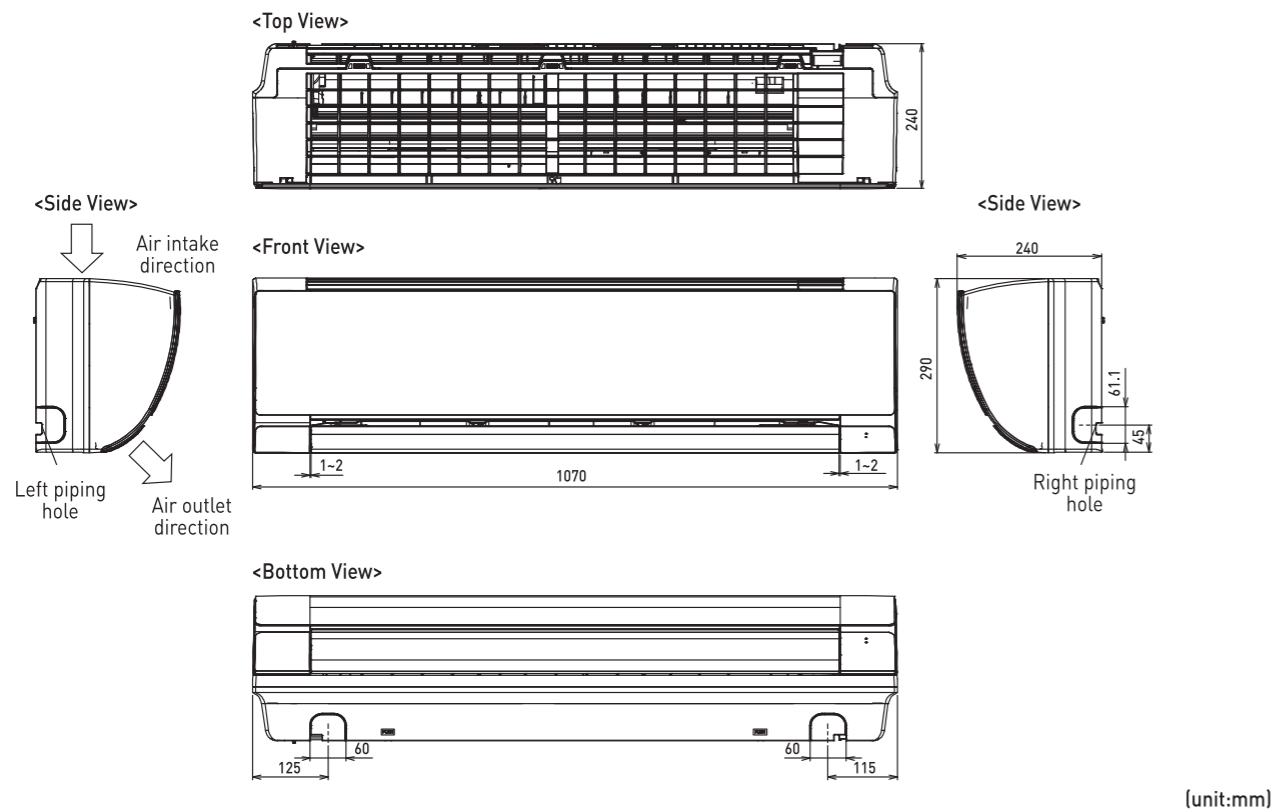

INDOOR DIMENSIONS / SLIM LOW STATIC DUCTED

CS-MS9SD3H / CS-MS12SD3H / CS-MS18SD3H / CS-MS24SD3H

