

Panasonic®

Operating and Installation Instructions

Ventilating Fan

Model No. / No. Model / 型号

FV-17CLM

FV-24CLM

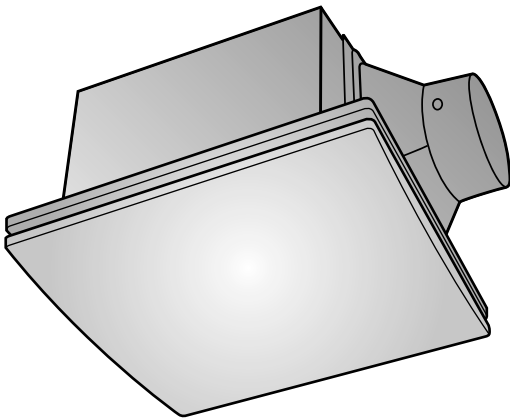

Operating and Installation Instructions Ventilating Fan

Thank you for purchasing this Panasonic product.
Before operating this product, please read the instructions carefully, and save this manual for future use.

Contents

Safety precautions	2-3
Name of parts	7
How to install	8-11
Maintenance	Back cover
Specifications	Back cover

Panduan Penggunaan dan Pemasangan Kipas Ventilasi

Terima Kasih kerana membeli produk Panasonic.
Sebelum mengoperasikan produk ini, sila baca arahan dengan teliti dan simpan manual ini untuk kegunaan pada masa akan datang.

Kandungan

Pencegahan keselamatan	4-5
Nama bahagian	7
Cara pemasangan	8-11
Penyelenggaraan	Muka belakang
Spesifikasi	Muka belakang



操作和 安装指示 换气扇

感谢您购买 Panasonic 产品。
操作此产品前，请仔细阅读说明书，并保存本手册以作日后参考。

目录









安全注意事项	6
零件名称	7
如何安装	8-11
维修	封底
规格	封底

To avoid the possibility of causing injury to users or damage to properties, please follow all the explanations written below.

 This symbol denotes an action that is COMPULSORY .	 This symbol denotes an action that is PROHIBITED .
--	---

WARNING

A state that may be caused by the mishandling of products, which, if not avoided, may lead to the possibility of death or serious injury of users.

-  **Follow strictly all the instructions given in this manual for installation. Electrical and installation work need to be performed by a qualified individual.**
Installation error may cause fire, electrical shock, injury or Ventilating Fan to drop.
-  **This appliance is not intended for use by persons (including children) with reduced physical, sensory or mental capabilities, or lack of experience and knowledge, unless they have been given supervision or instruction concerning the use of the appliance by a person responsible for their safety. Children should be supervised to ensure that they do not play with the appliance.**
-  **Means for disconnection must be incorporated in the fixed wiring in accordance with the wiring rules.**
-  **Switch off the power supply and wait until the Blades are fully static, before cleaning or doing any maintenance jobs.**
May cause injury or electrical shock if Ventilating Fan moves suddenly.
Kindly refer to your authorized dealer for repairing or maintenance.
-  **This product must be properly and reliably grounded.**
-  **When this product is no longer be used, it must not be left in place but removed to prevent it from possibly dropping.**
-  **Do not switch on or off in case of gas leakage.**
May cause fire or explosion due to electric spark.
-  **Do not use power supply other than rated voltage mentioned.**
Overheating may cause electrical shock or fire.







 **Do not disassemble Ventilating Fan unless stated by this manual.**
Must use only supplied parts.
May cause fire, electrical shock, injury or Ventilating Fan to drop.

 **Do not touch Ventilating Fan while it is operating.**
May cause injury, damage or Ventilating Fan to drop.

 **Do not sprinkle water to Ventilating Fan or do not wet Ventilating Fan.**
May cause fire or electrical shock due to short circuit.

CAUTION

A state that may be caused by the mishandling of products, which, if not avoided, may result in the injury of users or property damage.

-  **To avoid the possibility of causing injury to users or damage to properties, please follow all the explanation written in this manual. The manufacturer will not be responsible for any accidents or injuries caused by defective, deficient installation or installation which does not follow the instruction manual.**
-  **Be sure to provide an appropriate opening for air intake.**
-  **Install this product securely.**
-  **Make sure that a square inspection hole of at least 45 cm is available.**
-  **This Ventilating Fan must be installed by a qualified technician.**
May cause injury if Ventilating Fan drops.
-  **Use a device for disconnection from the supply, having a contact separation of at least 3 mm in double poles switch, which must be incorporated in the fixed wiring in accordance with the local electrical wiring rules.**
-  **Ventilating Fan must be mounted above 2.5 m from the floor.**

- !** This product must be install on to the ceiling which is enough strong, if the ceiling is not enough strong it must be reinforced for it to be strong enough.

- !** This fan should be installed so that the metal parts of the product and mounting screw do not contact any metallic members in the ceiling, such as metal laths, wire laths and metal plate, it is possible to cause fire harzards in case of leak.

- !** Routine maintenance is required every year. Disconnect the power source before you conduct any maintenance.

- !** If the supply cord is damaged, it must be replaced by the manufacturer or its service agent or a similarly qualified person in order to avoid a hazard.

- ⊘** This product is for in house use only.
Can cause rust, discolour, damage or injury.

- ⊘** Do not install this product in places with high temperature.

- ⊘** Do not install this product in places with excessive oil fume.

- ⊘** Do not install this product in places with steam.

- ⊘** Do not form the duct as shown below.

Adaptor assembly Corrugated pipe

- ⊘** For this fan, precautions must be taken to avoid the back-flow of gases into the room from the open-flue of gas or other fuel-burning appliances.

- ⊘** Do not install the power switch in the bathroom.



- ⊘** Do not install the Ventilating Fan outside of the window or the wall.

- ⊘** Never use petrol, benzene, thinner or any other such chemicals for cleaning the Ventilating Fan.

- ⊘** Do not allow water to contact electrical part such as motors or switches.

- ⊘** Do not immerse blade or other resin parts in hot water over 60 °C.

Untuk mengelakkan kemungkinan berlakunya kecederaan kepada pengguna atau kerosakan harta benda, sila patuhi semua penerangan yang dinyatakan di bawah.

 <p>Simbol ini menunjukkan perbuatan yang WAJIB DILAKUKAN.</p>	 <p>Simbol ini menunjukkan perbuatan yang DILARANG.</p>
---	---

AMARAN

Keadaan yang mungkin disebabkan oleh kecuaiian dalam mengendalikan produk, yang mana, jika tidak dielakkan, boleh mengakibatkan kematian atau kecederaan parah kepada pengguna.

 **Sila rujuk kepada semua arahan yang diberikan dalam panduan ini untuk pemasangan. Kerja elektrik dan kerja pemasangan mesti dilakukan oleh orang yang bertauliah.**

Kesilapan pemasangan boleh menyebabkan kebakaran, kejutan elektrik, Kipas Ventilasi terjatuh atau kecederaan.

 **Peralatan ini tidak direka untuk digunakan oleh individu (termasuk kanak-kanak) yang mempunyai kecacatan anggota, deria atau kebolehan mental, atau kurang pengalaman dan pengetahuan, melainkan mereka telah diberikan pemerhatian atau panduan mengenai penggunaan peralatan ini oleh individu yang bertanggungjawab mengenai keselamatan mereka. Kanak-kanak mestilah diberi pemerhatian untuk memastikan mereka tidak bermain dengan peralatan ini.**

 **Kaedah untuk memutuskan bekalan mesti dipasangkan pada pendawaian tetap mengikut peraturan pendawaian.**

 **Putuskan bekalan kuasa dan tunggu sehingga Bilah Kipas berhenti sepenuhnya, sebelum membersihkan atau membuat kerja penyelenggaraan. Boleh menyebabkan kecederaan atau kejutan elektrik jika Kipas Ventilasi bergerak secara tiba-tiba. Sila rujuk pada wakil penjual anda untuk membaiki atau penyelenggaraan.**

 **Produk ini mestilah diletakkan dengan betul dan kukuh.**

 **Apabila produk ini tidak lagi digunakan, ia tidak boleh dibiarkan begitu sahaja, tanggalkan ia untuk mengelakkan daripada terjatuh.**

 **Jangan hidupkan atau matikan suis jika berlaku kebocoran gas.**

Kebakaran atau letupan mungkin berlaku disebabkan oleh percikan elektrik.

 **Jangan gunakan bekalan kuasa selain dari voltan yang telah ditetapkan.**

Pemanasan yang terlampau boleh menyebabkan kejutan elektrik atau kebakaran.

 **Jangan buka sebarang bahagian-bahagian Kipas Ventilasi melainkan dinyatakan di dalam panduan ini.**

Hendaklah menggunakan bahagian-bahagian yang dibekalkan sahaja.

Boleh menyebabkan kebakaran, kejutan elektrik, kecederaan atau Kipas Ventilasi terjatuh.

 **Jangan sentuh Kipas Ventilasi ketika ia sedang beroperasi.**

Boleh menyebabkan kecederaan, kerosakan atau Kipas Ventilasi terjatuh.

 **Jangan percikkan air ke Kipas Ventilasi atau, jangan basahkan Kipas Ventilasi.**













Boleh menyebabkan kebakaran, atau kejutan elektrik akibat litar pintas.

AWAS

Keadaan yang mungkin disebabkan oleh salah pengendalian produk yang jika tidak dielakkan, boleh mengakibatkan kecederaan kepada pengguna atau kerosakan harta benda.





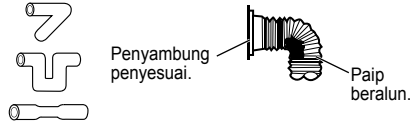

 **Untuk mengelakkan kemungkinan berlaku kecederaan kepada pengguna atau kerosakan harta benda, sila patuhi semua arahan yang dinyatakan dalam panduan ini. Pengilang tidak akan bertanggungjawab sekiranya berlaku sebarang kemalangan atau kecederaan yang disebabkan oleh kesilapan pemasangan atau pemasangan yang tidak mengikut buku panduan.**

 **Pastikan anda menyediakan pembukaan yang sesuai untuk salur masuk udara.**

-  **Pasang produk ini dengan betul.**
-  **Pastikan sekurang-kurangnya 45 cm lubang pemeriksaan segi empat disediakan.**
-  **Kipas Ventilasi ini mestilah dipasang oleh juruteknik yang berkelayakan.**
Boleh menyebabkan kecederaan, jika Kipas Ventilasi terjatuh.
-  **Gunakan peranti untuk pemutusan dari bekalan, sekurang-kurangnya 3 mm jauh daripada suis dua kutub yang mesti digabungkan dalam pendawaian tetap yang mengikut peraturan pendawaian elektrik tempatan.**
-  **Kipas Ventilasi mestilah dipasang dengan ketinggian 2.5 m dari lantai.**
-  **Produk ini mesti dipasang pada siling yang kukuh, jika siling tidak cukup kukuh, ia mestilah dikukuhkan untuk menjadi lebih kukuh.**
-  **Kipas ini mestilah dipasang agar bahagian logam produk dan skru pemasangan tidak tersentuh mana-mana bahagian berlogam pada siling seperti logam halus, wayar halus dan plat logam, ia mungkin menyebabkan bahaya kebakaran jika berlaku kebocoran.**
-  **Penyelenggaraan rutin diperlukan setiap tahun. Putuskan sumber kuasa sebelum anda melakukan apa-apa penyeleggaran.**
-  **Jika kord kuasa rosak, ia mesti digantikan oleh pengilang atau ejen servisnya atau individu yang berkelayakan sama untuk mengelakkan bahaya.**
-  **Produk ini untuk kegunaan dalam rumah sahaja.**
Boleh menyebabkan karat, berubah warna, kerosakan atau kecederaan.
-  **Jangan pasang produk ini di tempat bersuhu tinggi.**
-  **Jangan pasang produk ini di tempat yang dipenuhi asap berminyak.**
-  **Jangan pasang produk ini di tempat yang berwap.**

-  **Jangan membentuk salur seperti yang ditunjukkan di bawah.**



-  **Untuk kipas ini, langkah berhati-hati mesti diambil untuk mengelakkan pengaliran balik gas ke dalam bilik dari serombong terbuka gas atau peralatan pembakaran bahan api yang lain.**
-  **Jangan pasang suis kuasa di dalam bilik air.**
-  **Jangan pasang Kipas Ventilasi di luar tingkap atau dinding.**
-  **Jangan gunakan petrol, benzena, bahan pencair atau apa-apa bahan kimia yang lain untuk membersihkan Kipas Ventilasi.**
-  **Jangan biarkan air terkena bahagian elektrik seperti motor atau suis.**
-  **Jangan rendam bilah atau bahagian resin lain di dalam air panas yang melebihi 60 °C.**

安全注意事项 务必遵循以下指示

为避免导致用户受伤或财物损坏的可能性，请遵守以下所述的所有指示。



此符号表示有关行为是**强制性的**。



此符号表示有关行为是**被禁止的**。



警告

错误操作产品造成的结果，若不避免可能导致用户死亡或严重受伤。



安装时请严格地遵守本手册内所给的所有指示。电线配线和安装工作必须由有资格的专业人员进行。

安装错误可能导致火灾、触电、受伤或换气扇掉落。



除非由安全监护人就本产品进行监督或指导，否则身体、感官或智力有功能障碍者，或者缺乏相关经验和知识的人士（包括儿童）请勿使用本产品。应确保儿童不要把本产品当作玩具玩。



断开连接的方式必须按照固定布线里的接线规则。



清扫或进行任何维修工作前，关闭所有电源并等待扇翼完全静止。

若换气扇突然运转，可能致受伤或触电。

请向您的经销商咨询有关修理或维修的详情。



本产品必须以正确与安全的方式接地。



长时间不使用本产品时，切记不得将之留在原位，应将它取下以防止其掉落。



请勿在煤气泄漏的情况下开关本产品。

电火花可能导致起火或爆炸。



切勿使用本文指定的额定电压以外的电源。

过热可导致触电或火灾。



请勿拆除换气扇，除非此说明书指示。

务必只使用附带的零件。

可能导致火灾、触电、受伤或换气扇掉落。



请勿在换气扇正在运转的时候触摸换气扇。

可能导致受伤、损坏或换气扇掉落。



切勿向换气扇洒水。或者，切勿弄湿换气扇。

可能以导致火灾或电源短路而触电。



注意

错误操作产品造成的结果，若不避免可能导致用户受伤或财物损失。



为避免导致用户受伤或财物损坏的可能性，请遵守本说明书内的所有指示。制造商对任何因不正确的安装或不按照说明书指示的安装所造成的任何意外和损伤将不负任何责任。



确保提供适当的进气口



牢固地安装本产品。



确保留有一个至少 45 cm 大的方形式检查孔。



此换气扇必须由有资格的专业人员安装

若换气扇掉落会导致受伤。



在安装时，需在供电线路中安装其触点开距不小于 3 mm 的双极断开装置，必须按照当地的电气配线的规定进行连接。



换气扇必须安装在离地 2.5 m 以上的高度位置上。



产品必须安装在足够强硬的天花板上，如果天花板不够强硬，在安装之前必须先将它强化。



安装换气扇时，安装螺钉等金属部件禁止借助于天花板中的金属条、线槽或金属板等金属部件材料进行接地，以防止发生漏电现象而导致火灾。



每年需要进行例行维护。在您进行任何维护之前请断开电源。



如果电线损坏，必须由制造商或其服务代理或有资格的专业人员更换，以避免危险。



本产品仅供室内使用。

可能会导致锈蚀，变色，损坏或受损。



请勿将本产品安装在高温的地方。



请勿将本产品安装在有过多油烟的地方。



请勿将本产品安装在有蒸汽的地方。



请勿形成如下所示的管道。

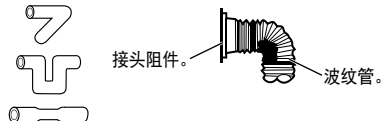

使用本换气扇，必须采取预防措施，以避免气体从敞开的气道或其它的明火设备回流进室内。



请勿在浴室中安装电源开关。



请勿将换气扇安装在窗户或墙壁的外面。



切勿使用汽油、苯、天那水，或任何其它此类化学品来清洁换气扇。



请勿让水接触电气部件，例如马达或开关。



请勿将叶片或其他树脂部件浸入 60 °C 以上的热水中。

Dimension / Dimensi / 尺寸

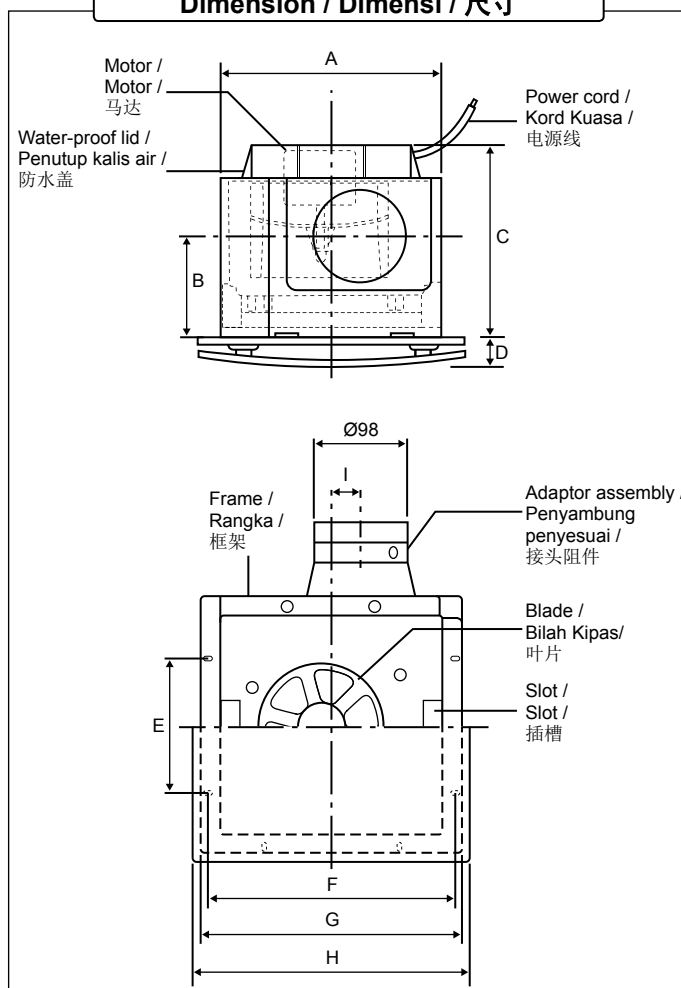
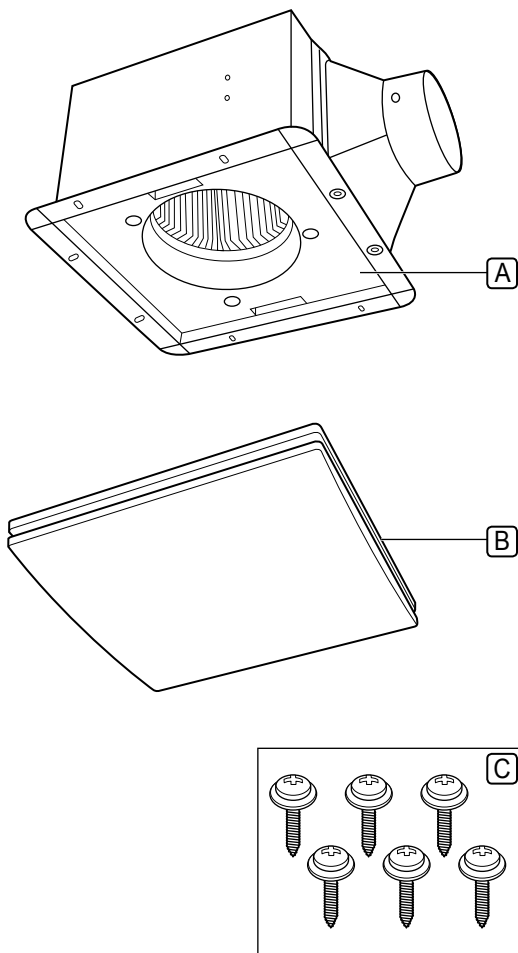

Parts	piece(s)	Bahagian-bahagian	unit	零件	件
A Fan Body	1	A Badan Kipas	1	A 扇体	1
B Louver	1	B Ram	1	B 百叶窗	1
C Tapping Screw	6	C Skru Tetapan	6	C 攻丝螺丝	6

Model / Model / 型号	Measurement / Ukuran / 测量 (mm)									Duct Size / Saiz Salur / 管道尺寸
	A (Square / Persegi / 正方形)	B	C	D	E	F	G (Square / Persegi / 正方形)	H (Square / Persegi / 正方形)	I	
FV-17CLM	170	108	184	34	84	194	214	240	10	Ø100
FV-24CLM	230	110	200	38	140	255	278	300	10	Ø100

■ Attention:

- Do not place Ventilating Fan directly on the floor. It may cause scratches to the product.

■ Note:

- The illustrations in this manual are for explanation purposes only and may differ from the actual unit.

■ Perhatian:

- Jangan letak Kipas Ventilasi di atas lantai. Ia boleh menyebabkan kesan calar pada produk.

■ Nota:

- Ilustrasi pada buku panduan ini adalah untuk tujuan penerangan sahaja dan mungkin berbeza dari unit asal.

■ 留意:

- 请勿将换气扇直接摆放在地板上。否则可能会划伤产品。

■ 备注:

- 本手册中的插图仅用于说明，可能与实际组件有所不同。

1 Identify your ceiling structure and choose one of the methods shown below.

1-A Fan Body Installation (with a wooden keel)

- ① Remove the caution label **a** and adhesive tape from the adaptor assembly.
- ② Build a wooden frame **c** horizontally from the wooden keel **b**. Note that the distance between the top of Fan Body **A** and the roof (attic) should be at least 20 mm.
- ③ Firmly secure Fan Body **A** with 6 Tapping Screws **C**.

Kenal pasti struktur siling anda dan pilih satu daripada kaedah yang ditunjukkan di bawah.

1-A Pemasangan Badan Kipas (dengan lunas kayu)

- ① Tanggalkan label amaran **a** dan pita pelekat dari penyambung penyesuai.
- ② Bina rangka kayu **c** secara mendatar dari lunas kayu **b**. Jarak di antara bahagian atas Badan Kipas **A** dan bumbung (loteng) memerlukan sekurang-kurangnya 20 mm.
- ③ Ketatkan Badan Kipas **A** dengan 6 Skru Tetapan **C**.

确定您的天花板结构，并选择以下所示的方法之一。

1-A 扇体安装（带木制龙骨）

- ① 取下接头阻件的警告标签 **a** 和胶带。
- ② 用木框 **b** 横向建立一个木制框架 **c**。注意，扇体 **A** 和屋顶（阁楼）应该至少距离 20 mm。
- ③ 用 6 个攻丝螺丝 **C** 将扇体 **A** 牢牢固定。

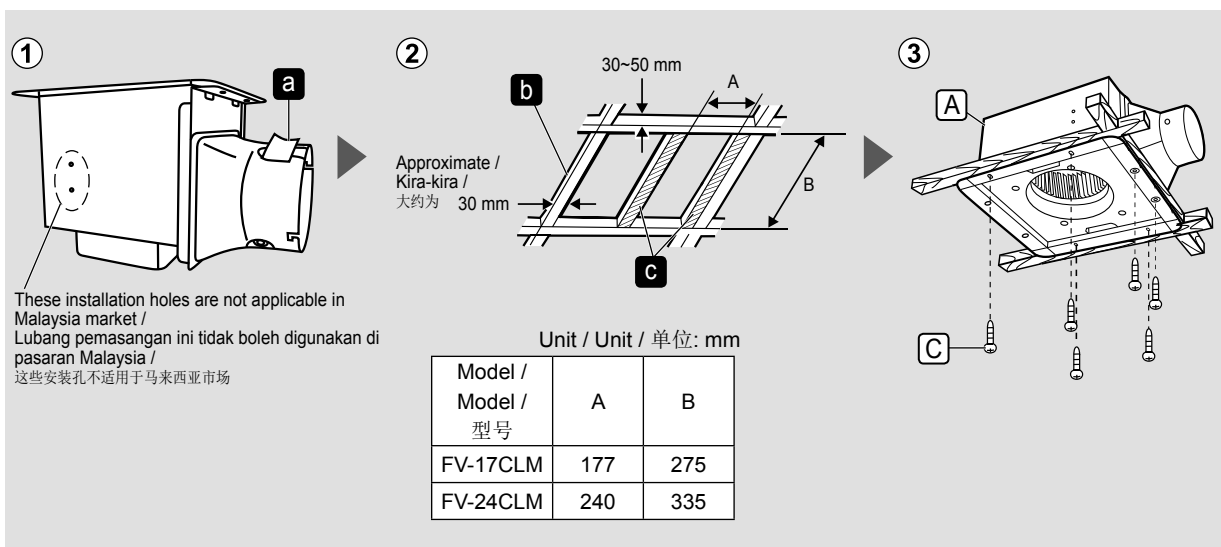

1-B Fan Body Installation (install the adaptor assembly first)

- ① First remove the hexagon screw **h** attaching the adaptor assembly to Fan Body **A**.
- ② Remove the adaptor assembly by pushing up ① and pulling to the direction ②. Then peel off the caution label **a** and adhesive tape from the adaptor assembly.
- ③ Build a wooden frame **c** horizontally from the wooden keel **b**. Note that the distance between the top of the fan body and the ceiling should be at least 20 mm.

1-B Pemasangan Badan Kipas (pasang penyambung penyesuai terlebih dahulu)

- ① Tanggalkan skru heksagon **h** yang menyambungkan penyambung penyesuai ke Badan Kipas **A** dahulu.
- ② Tanggalkan penyambung penyesuai dengan menekan ke atas ① dan tarik ke arah ②. Kemudian cabut label amaran **a** serta pita pelekat pada penyambung penyesuai.
- ③ Bina rangka kayu **c** secara mendatar dari lunas kayu **b**. Jarak di antara bahagian atas badan kipas dan siling perlulah sekurang-kurangnya 20 mm.

1-B 扇体安装（先安装接头阻件）

- ① 先取下在扇体 **A** 上附着接头阻件的六角螺钉 **h**。
- ② 向上推动 ① 并拉到方位 ② 拆下接头阻件。然后取下接头阻件的警告标签 **a** 和胶带。
- ③ 用木框 **b** 横向建立一个木制框架 **c**。注意，扇体和天花板应该至少距离 20 mm。

- ④ Attach the adaptor assembly to the wooden frame **c** as shown in the figure.
- ⑤ Insert Fan Body **A** in the wooden frame **c**, and connect it to the adaptor assembly.
- ⑥ Firmly secure Fan Body **A** with 4 Tapping Screws **C** and a hexagon screw **h**.

- ④ Pasang penyambung penyesuai pada rangka kayu **c** seperti yang ditunjukkan di dalam gambar.
- ⑤ Masukkan Badan Kipas **A** ke dalam rangka kayu **c**, dan sambungkan ke penyambung penyesuai.
- ⑥ Ketatkan Badan Kipas **A** dengan 4 Skru Tetap **C** dan satu skru heksagon **h**.

- ④ 将接头组件如图所示般安装到到木框一边 **c**。
- ⑤ 在木框 **c** 里置入扇体 **A**，并将其连接到接头组件。
- ⑥ 使用4个攻丝螺丝 **C** 以及六角螺钉 **h** 将扇体 **A** 牢牢固定。

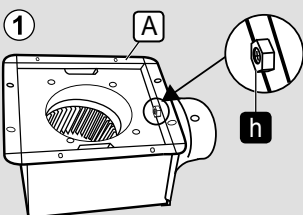

①

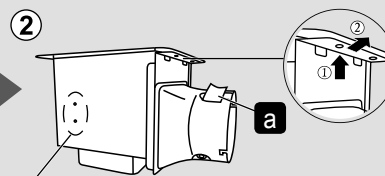

②

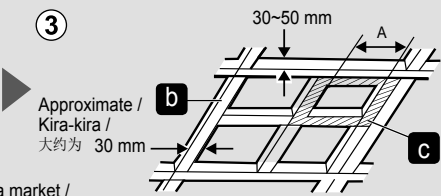

③

These installation holes are not applicable in Malaysia market /
Lubang pemasangan ini tidak boleh digunakan di pasaran Malaysia /
这些安装孔不适用于马来西亚市场

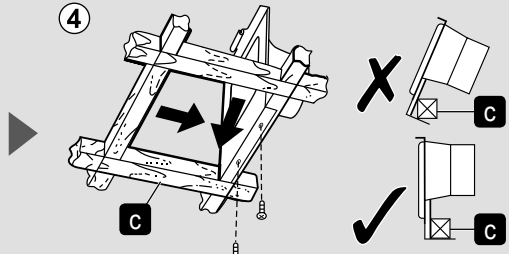

④

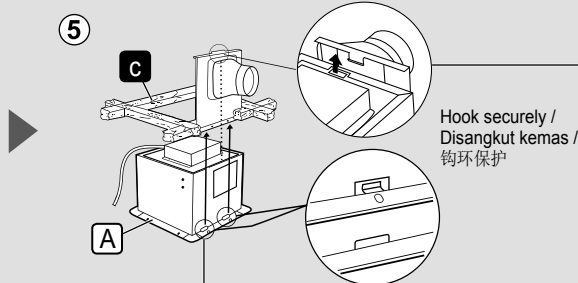

⑤

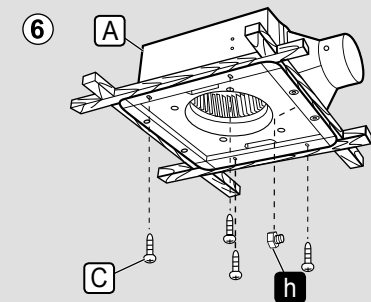

⑥

FV-17CLM

Correct Position /
Posisi Betul /
正确位置

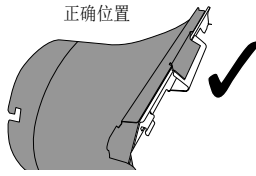

Wrong Position /
Posisi Salah /
错误位置

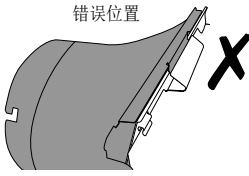

Hook is fully insert /
Cangkuk masuk sepenuhnya /
钩子完全插入

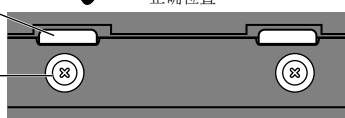

✓ Correct Position /
Posisi Betul /
正确位置

Screw is in center /
Skru berada di tengah /
螺丝在中心

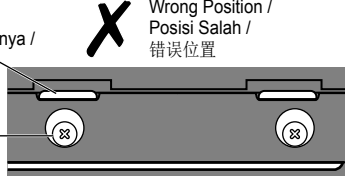

✗ Wrong Position /
Posisi Salah /
错误位置

Hook is not fully insert /
Cangkuk tidak masuk sepenuhnya /
钩子没有完全插入



✗ Wrong Position /
Posisi Salah /
错误位置

Screw is overlapped with
Fan Body /
Skru bertindih dengan
Badan Kipas /
螺丝与扇体重合



✗ Wrong Position /
Posisi Salah /
错误位置

Unit / Unit / 单位: mm

Model / Model / 型号	A (Square / Persegi / 正方形)
FV-17CLM	177
FV-24CLM	240

2 Power Cord Connection.

- Make sure all connections are fastened firmly after wiring is finished.
- It is required to use terminal (not included) that complies IEC 60998.
- All connections should be accommodated in a suitable compartment.

Sambungan Kord Kuasa.

- Pastikan semua sambungan diketatkan selepas pendawaian selesai.
- Penggunaan terminal (tidak dibekalkan) yang mematuhi IEC 60998 adalah diperlukan.
- Semua sambungan perlu ditempatkan di ruang yang sesuai.

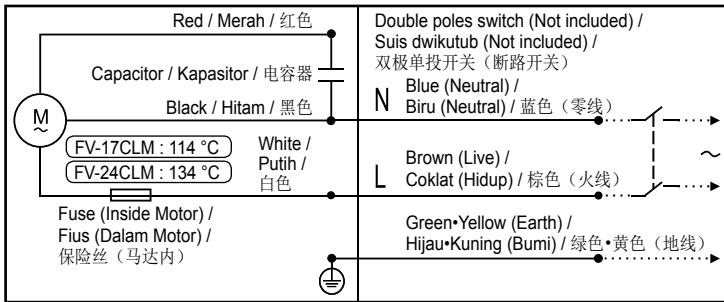

电线连接。

- 接线完成后，确保所有连接牢固。
- 需要使用符合 IEC 60998 的线接头。（自备）
- 所有连接都应放置在合适的隔间中。

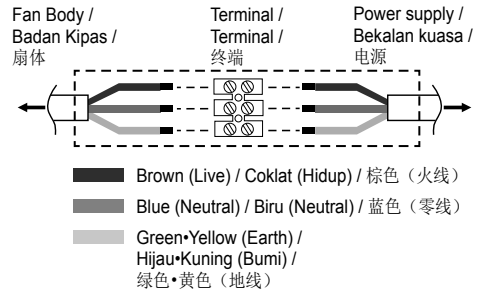

3 Duct Connection and Ceiling Plate Installation.

- ① Insert the duct **i** into the adaptor assembly, and tighten it with adhesive tape (not supplied). (Suspend the duct **i** from the ceiling to prevent any external force onto Fan Body **A**.)
- ② Install the ceiling plate **f**. Note that the gap **k** between the flange **l** and the ceiling plate **f** should be 2 to 3 mm.
- ③ Slope the duct **i** downward and guide it through the wall to the outside. Be sure to prevent rainwater from falling in the duct **i** from its outlet. (The minimum size of the hole opening on the wall is $\varnothing 116$ mm)
- ④ Install the pipe hood or vent cap (optional accessories) on the outer wall.

■ Note:

- Optional accessories and duct **i** are not provided by manufacturer.

Sambungan Salur dan Pemasangan Plat Siling.

- ① Masukkan salur **i** ke dalam penyambung penyesuai dan ketatkannya dengan pita pelekat (tidak dibekalkan). (Gantung salur **i** dari siling bagi mencegah sebarang daya luar pada Badan Kipas **A**.)
- ② Pasang plat siling **f**. Pastikan jarak **k** di antara bebibir **l** dan plat siling **f** mestilah 2 hingga 3 mm.
- ③ Condongkan salur **i** ke bawah dan salurkannya melalui dinding ke bahagian luar. Elakkan air hujan dari jatuh ke dalam salur **i** dari salur keluarnya. (Saiz minimum pembukaan lubang pada dinding ialah $\varnothing 116$ mm)
- ④ Pasang hud paip atau penutup lubang (aksesori pilihan) pada dinding luar.

■ Nota:

- Aksesori pilihan dan salur **i** tidak disertakan oleh pengilang.

管道连接和天花板安装。

- ① 将管道 **i** 置入接头组件中并用胶带（自备）将其紧固。（挂起天花板中的管道 **i**，以防止任何外力施加到扇体 **A** 上。）
- ② 安装天花板嵌板 **f**。注意，凸缘 **l** 和天花板嵌板 **f** 的间隙 **k** 应为 2 至 3 mm。
- ③ 将管道 **i** 向下倾斜，并引导它通过墙壁到外面。必须防止雨水从其出口落入管道 **i**。（壁上开孔的最小尺寸为 $\varnothing 116$ mm）
- ④ 将管罩和管盖（需要另外选购）安装到墙外。

■ 备注:

- 可选配件和管道 **i** 不由制造商提供。

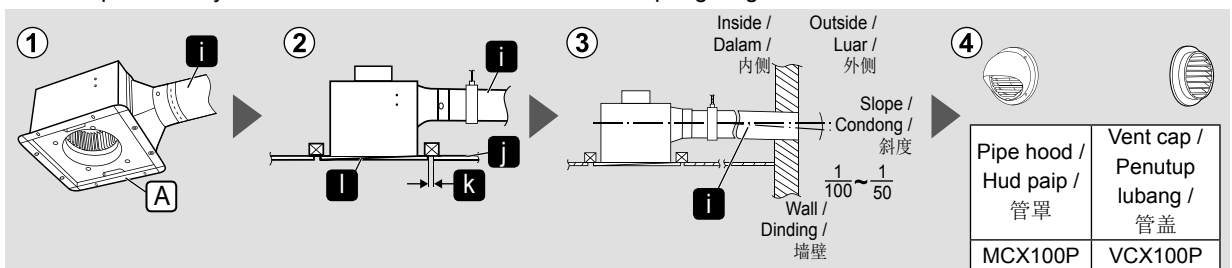

4 Test Run and Louver Installation

- ① When the power is turned on, check for malfunctions as follow:
 - Does the fan rotate correctly?
 - Does the fan rotate anti-clockwise?
 - Is there any abnormal sound or vibration?
- ② Insert the mounting spring **n** by pressing the spring ① and put in direction ② into the slots **m**. Then mount Louver **B** to Fan Body **A**. (Please wear gloves during installation.)

Ujian Operasi dan Pemasangan Ram

- ① Apabila kuasa dihidupkan, periksa kerosakan seperti yang berikut:
 - Adakah kipas berputar dengan betul?
 - Adakah kipas berputar melawan arah jam?
 - Adakah terdapat bunyi yang luar biasa atau getaran?
- ② Masukkan spring pendakap **n** dengan memampatkan spring ① dan letakkan ke arah ② ke dalam slot **m**. Kemudian pasang Ram **B** ke Badan Kipas **A**. (Sila pakai sarung tangan semasa pemasangan.)

测试运行和百叶窗安装

- ① 当电源开启时，检查以下故障：
 - 扇叶是否正确旋转？
 - 扇叶是否逆时针旋转？
 - 是否有异常声音或振动？
- ② 按住弹簧 ① 插入安装弹簧 **n**，将方位 ② 插入插槽 **m**。然后将百叶窗 **B** 安装到扇体 **A**。（安装时请戴上手套。）

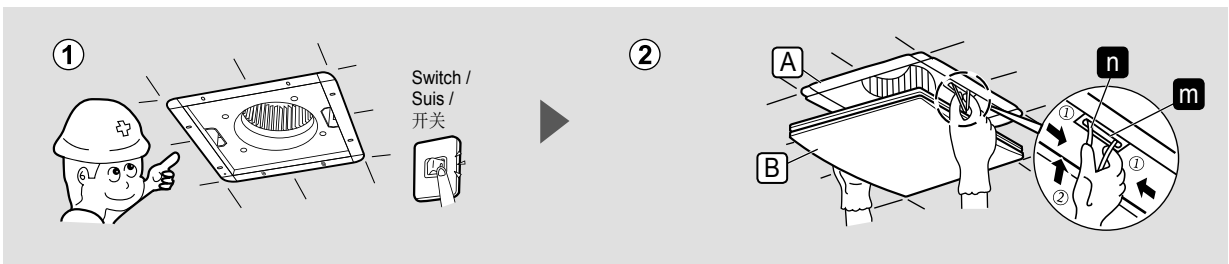

- Remove Louver **B** by pressing the spring **1** and pull out in direction **2**.

■ **Note:**

- Do not dismantle Louver **B** into two pieces.

- Rinse Louver **B** with water and then dry it with a soft dry cloth or leave it air dry. (Do not dry by direct sunlight or heat.)

- Clean the dirt off Fan Body **A** with a suction cleaner **q**.

- Wipe the dust off Fan Body **A** with a soft cloth moistened with kitchen detergent, and then clear it with a clean soft cloth. Finally, install Louver **B**. (Refer Step 4 - **2** on page 11.)

- Tanggalkan Ram **B** dengan memampatkan spring **1** dan tarik keluar ke arah **2**.

■ **Nota:**

- Jangan pisahkan Ram **B** kepada dua bahagian.

- Bilas Ram **B** dengan air dan kemudian keringkannya dengan kain kering yang lembut atau biarkannya kering. (Jangan keringkan di bawah sinaran matahari atau haba.)

- Bersihkan kotoran pada Badan Kipas **A** dengan pembersih hampagas **q**.

- Lap habuk pada Badan Kipas **A** dengan kain lembut yang dilembapkan dengan pencuci dapur dan kemudian bersihkan dengan kain lembut yang bersih. Akhir sekali, pasang Ram **B**. (Rujuk Langkah 4 - **2** pada muka surat 11.)

- 按下弹簧 **1** 并拉出方向 **2** 以拆下百叶窗 **B**。

■ **备注:**

- 切勿将百叶窗 **B** 拆分成两块。

- 用水冲洗百叶窗 **B**，然后用柔软的干布将其擦干或将其风干。(请勿采用阳光直射或直接加热的方式进行干燥。)

- 使用吸尘器 **q** 清洁扇体 **A**。

- 将柔软的布弄湿后沾上厨房洗涤剂，擦掉扇体 **A** 上的灰尘，然后用干净的软布将其清除。最后，装上百叶窗 **B**。(请参步骤 4 - **2**，第 11 页。)

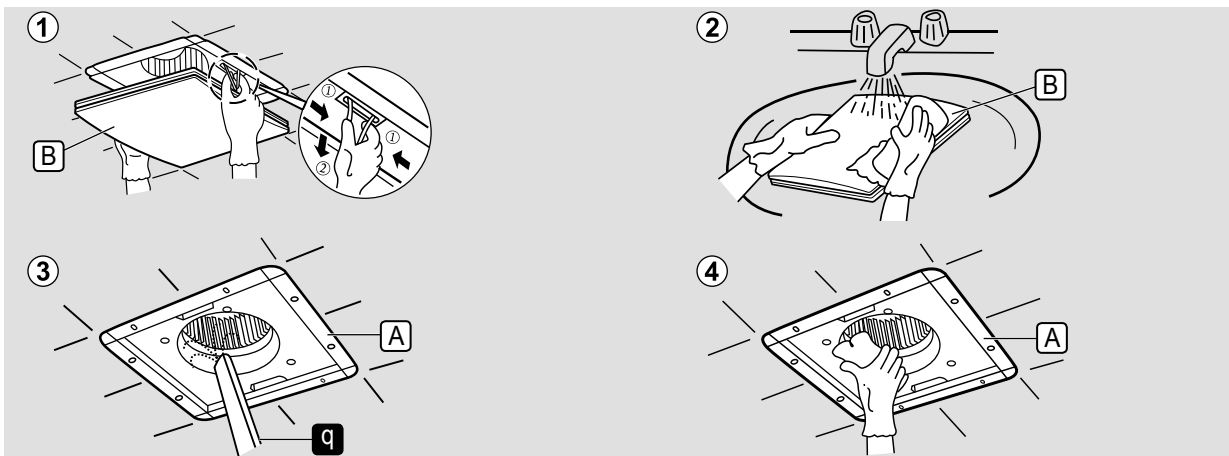

Specifications

Spesifikasi

规格

Model	Model	型号	FV-17CLM	FV-24CLM
Voltage (V)	Voltan (V)	电压 (V)	240	240
Frequency (Hz)	Frekuensi (Hz)	频率 (Hz)	50	50
Power Consumption (W)	Penggunaan Kuasa (W)	功率 (W)	13	17
Air Delivery (m ³ /h)	Sebaran Angin (m ³ /h)	排气量 (m ³ /h)	90	160
Noise (dB(A))	Hingar (dB(A))	噪音 (dB(A))	29	31
Static Pressure (Pa)	Tekanan Statik (Pa)	静压 (Pa)	110	100
Net Weight (kg)	Berat Bersih(kg)	净重 (kg)	2.0	3.1

Insulation class E
Penebat kelas E
E 级绝缘

IP code:IPX2
Kod IP:IPX2
防水等级:IPX2

Type of Insulation: Functional Insulation
Jenis Penebat: Penebat Berfungsi
绝缘种类:机能绝缘