

# Panasonic®

## Operating & Installation Instructions

Washing Machine (Household Use)

Model No. **NA-V115FA1 NA-V10FA1 NA-V90FA1**



It is essential to read these instructions.

EN

Thank you for purchasing this product.

- Read these instructions carefully for optimum performance and safety before use.
- Keep this manual for future reference.

### Contents

Safety Precautions	2	
Checking Your Washing Machine Before Washing	6	
Control Panel	7	
Detergent	8	
Washing	10	
Program List	12	
Details of Programs	14	
Washing Tips	16	
Changing Program Settings	18	
Changing Appliance Settings	20	
Maintenance	24	
Troubleshooting	25	
Error Display	29	
Installation	Choosing the Right Location	35
	Moving and Installing	36
	Connecting the Hoses	37
	Test Run	39
Specifications	41	
	42	

# Safety Precautions

## **WARNING**

### May cause serious injury or death

**Children must not use it alone.**



- This appliance is not intended for use by persons (including children) with reduced physical, sensory or mental capabilities, or lack of experience and knowledge, unless they have been given supervision or instruction concerning use of the appliance by a person responsible for their safety.
- Children should be supervised to ensure that they do not play with the appliance.

**Setting the Child Lock. (P. 24)**



**Hold 5 sec.**



### May cause fire or electric shock

**Do not touch it with wet hands.**



**Do not hold or pull on the cord.**

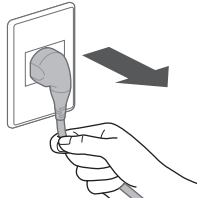

**Do not use.**



**Plug adaptor**

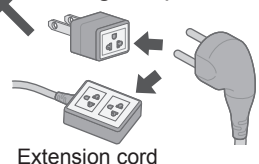

**Extension cord**

**Fully insert it.**

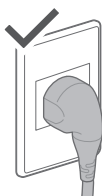

**Do not use.**

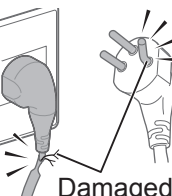

**Damaged**

- If the power cord is damaged, it must be replaced by the manufacturer, its service agent or similarly qualified persons in order to avoid a hazard.

**In case of failure or damaged power cord, stop use and ask the electrical technician.**

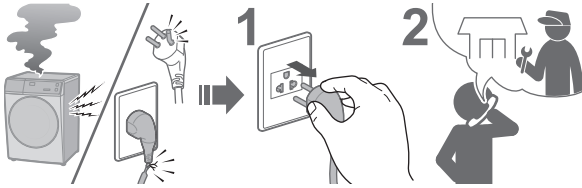

**Accumulated dust may cause fire.**

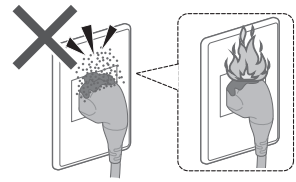

**Securely insert the ground prong. Ask the electrical technician for a new socket.**

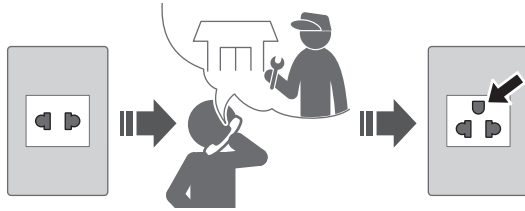

**Wipe the power plug periodically.**



**Use a socket appropriate for this appliance.**

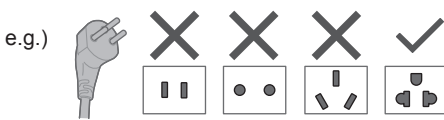

- The plug shape, socket shape and rating requirement vary with the region.

**Keep away from flammable materials.**



## May cause failure

**Do not disassemble, repair or modify it by yourself.**



# Safety Precautions (continued)



## CAUTION

### May cause injury

Be careful not to get your fingers caught.

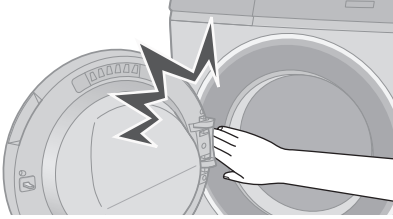

Do not climb on the appliance.

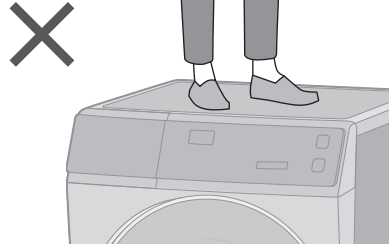

Do not touch when it is hot.

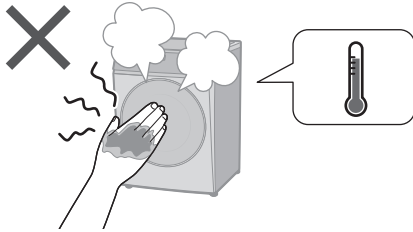

### May cause water leakage

Turn off the water faucet.



Use new hose-sets.

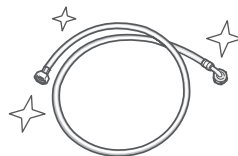

- New hose-sets supplied with the appliance are to be used and old hose-sets should not be reused.

■ For maximum mass of dry cloth and pressure of tap water, see P. 42.

## May cause failure

**Keep away from heat and direct sunlight.**

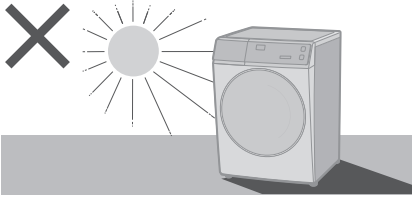

**Remove anchor bolts before operation.**

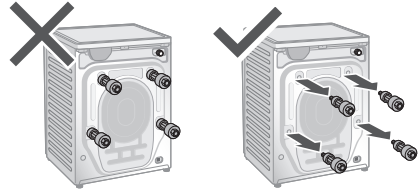

**Do not obstruct.**

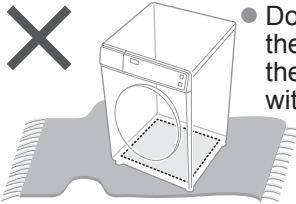

- Do not obstruct the openings of the bottom face with carpet, etc.

**Do not use hot water.**

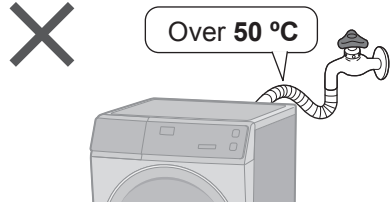

**For machine-washable items only.**

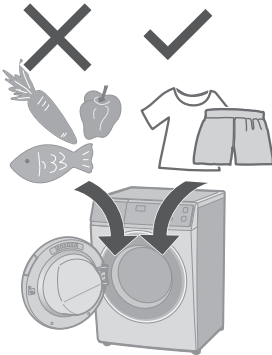

- This appliance is intended to be used in household. This appliance is not intended to be used in applications such as:
  - staff kitchen areas in shops, offices and other working environments;
  - farm houses;
  - by clients in hotels, motels and other residential type environments;
  - bed and breakfast type environments;
  - areas for communal use in blocks of flats or in laundrettes.

**Do not wash excessively oily clothes.**



# Checking Your Washing Machine

## Part names

Detergent drawer (P. 10)

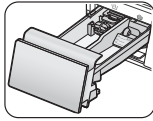

Control panel (P. 8)

Door

Drum

Hinge

Door seal

Adjustable feet (P. 38)

Drain filter cover (P. 28)

Drain hose (P. 39, 40)

Water inlet (P. 40)

Anchor bolts (P. 38)

Power cord and plug\*  
\*The plug shape varies with the region.

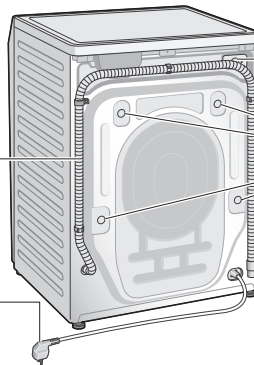

## Accessories

Elbow (1) (P. 40)



Cover caps (4) (P. 38)



Water supply hose (1) (P. 39, 40)

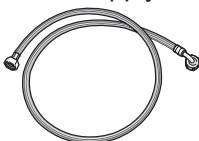

Bottom cover (1) / Screw (1) (P. 37)

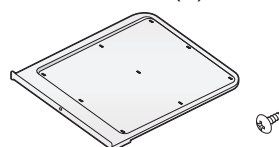

# Before Washing

## Preparing laundry

### Before put clothes in drum

- Remove foreign objects.

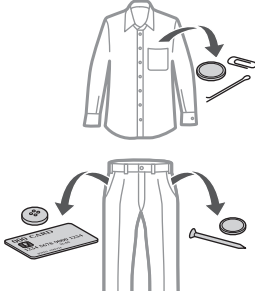

- Use laundry nets for delicates and small items.

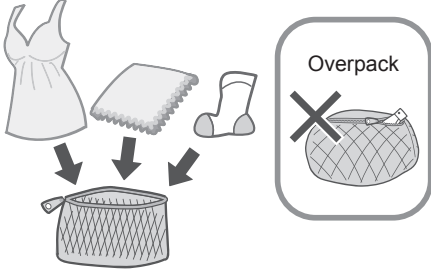

### Pre-laundry check

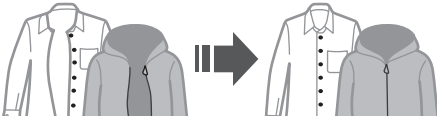

Reverse



Clothes likely to pill

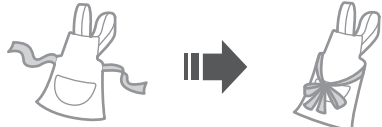
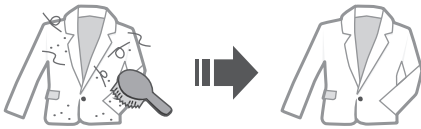

- Observe care labels.



- Wash separately.

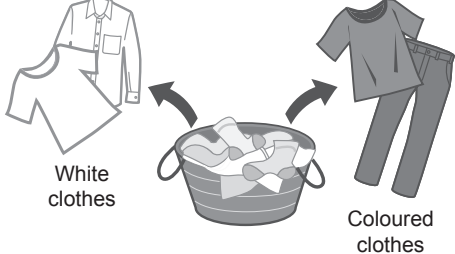

- Pretreat for heavily stains.



NOTE

- "Mud" program (P. 15) are recommended for removing stains.

# Control Panel

## Display

Remaining time



1:15

Error display (P. 35)

U



11

(e.g. U11)

Lock



The door is locked



The door and buttons are all locked (Child Lock) (P. 32)

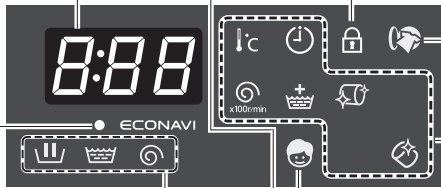

Add Wash lamp:  
You can add clothes while lit. (P. 12)

Optional function lamp



(P. 22)



(P. 27)



(P. 23)



(P. 23)



Water temperature



Spin speed

Process



Wash



Rinse



Spin

ECONAVI lamp  
(P. 18)



# Control buttons

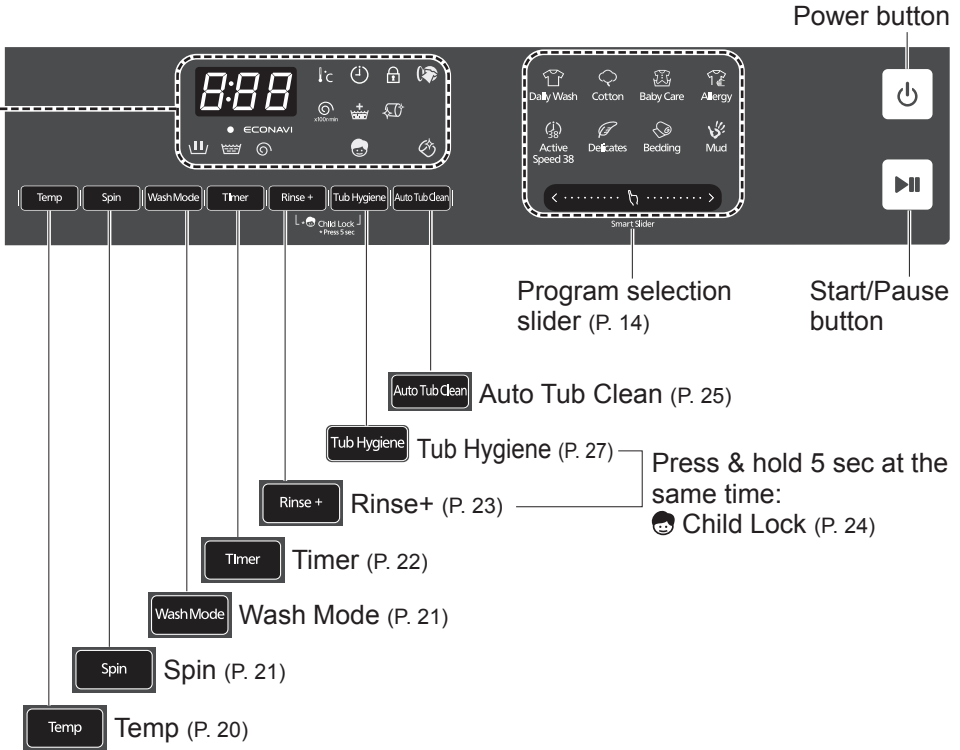

## Touch operation

- If water, detergent or softener gets on, turn off and wipe off with a towel etc. immediately. (Cause of malfunction)

The illustrations show: 1. A hand touching the panel with a towel (marked with an X). 2. A hand touching the panel with a finger (marked with an X). 3. A hand touching the panel with a finger (marked with a checkmark).

### NOTE

- Turn off back on (3 sec.) On
- No operation auto power off (Not pressed ) Auto Power off (10 min.)
- In case of a power failure When the power recovers, operation resumes from where it stopped. (Auto Restart)

# Detergent

- Follow the instructions on each package.

## Detergent

Use a low foam detergent.

- To prevent powder detergent from remaining in the detergent drawer:

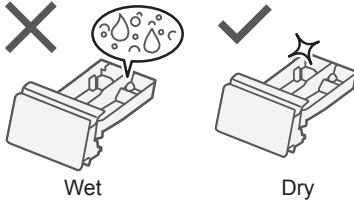

Wet

Dry

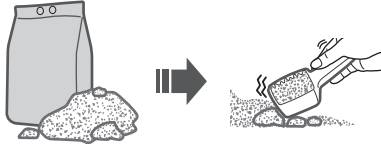

Lumps

Powder

## Detergent

Powder detergent

Liquid detergent



Bleach



## Fabric softener

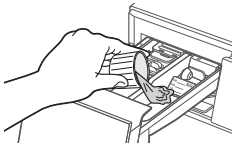

Separated or solidified softeners

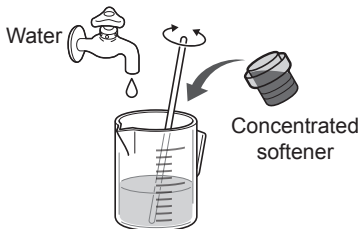

NOTE

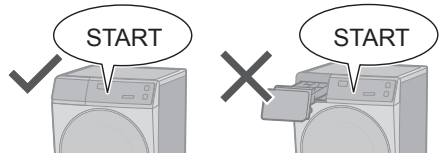

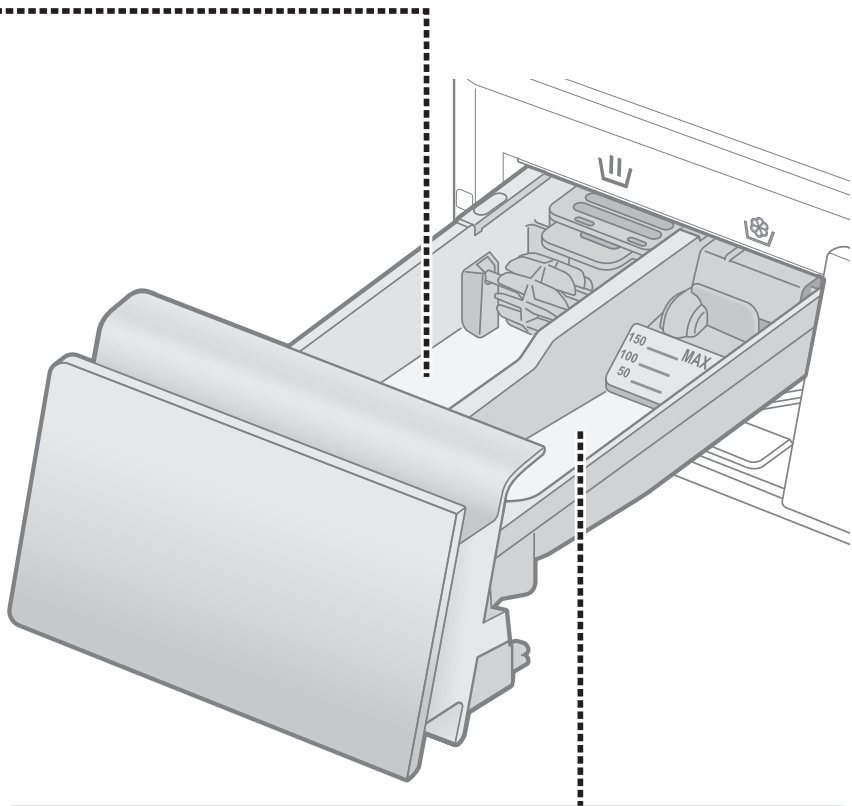

 **Fabric softener**



Max. 150 ml

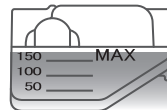
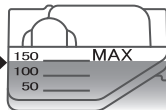

# Washing

## Basic Method

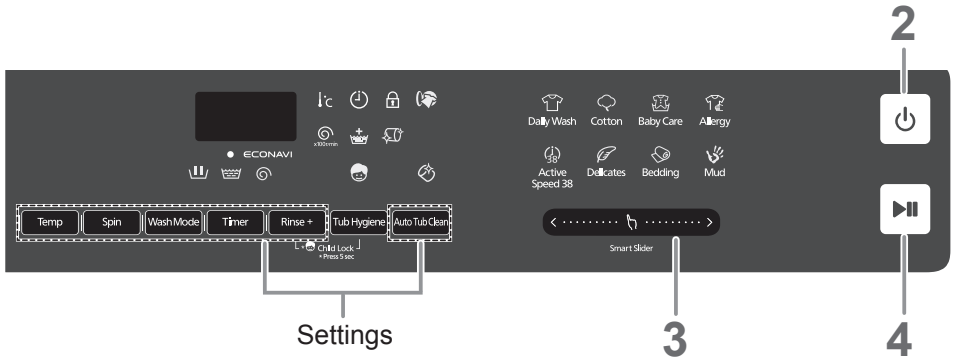

### NOTE

■ Do not let laundry get caught in the door.



■ Do not overfill the drum with laundry.

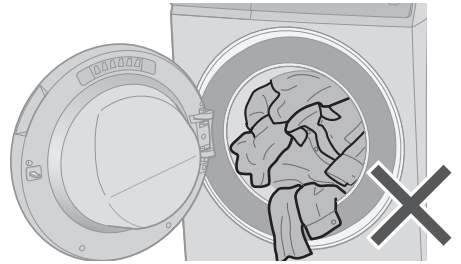

■ To open the door during operation

● During washing

(You can add clothes when lit.)

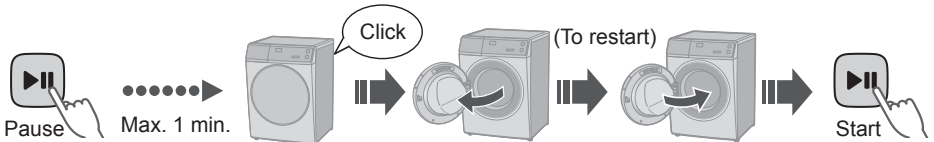

### NOTE

● Door does not open (P. 30)



1

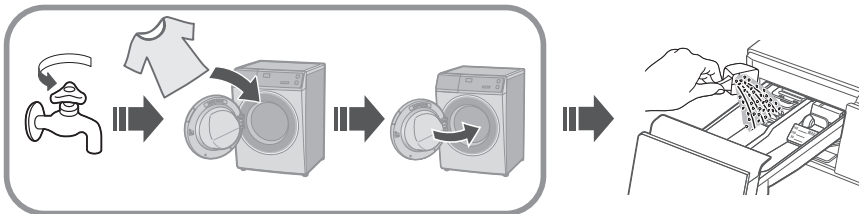

2



On

3









Smart Slider

Select a program. (P. 14)

■ Changing the settings.

### Settings

 Temp (P. 20)	 Spin (P. 21)	 Wash Mode (P. 21)
 Timer (P. 22)	 Rinse+ (P. 23)	 Auto Tub Clean (P. 23)

4



Start



Measures the amount of laundry

(30 sec.)



Displays the time required (recalculated)



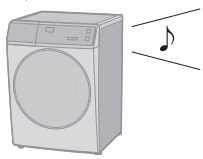







(e.g.)











5











# Program List

Program	Description	Max load (kg)			Total time
		V115FA1	V10FA1	V90FA1	
 <b>Daily Wash</b>	<ul style="list-style-type: none"> <li>● Everyday clothes (Quicker than “Cotton” program)</li> </ul> 	11.5	10.0	9.0	1:30
 <b>Cotton</b>	<ul style="list-style-type: none"> <li>● Everyday clothes</li> </ul> 	11.5	10.0	9.0	2:54
 <b>Baby Care</b>	<ul style="list-style-type: none"> <li>● Clothes for babies &amp; sensitive skin</li> <li>Rinsing thoroughly</li> </ul> 		5.0		2:20
 <b>Active Speed 38</b>	<ul style="list-style-type: none"> <li>● Small loads</li> </ul> 		5.0		0:38
 <b>Bedding</b>	<ul style="list-style-type: none"> <li>● Large items</li> </ul> 		3.0		1:30

Program	Description	Max load (kg)			Total time
		V115FA1	V10FA1	V90FA1	
 <b>Delicates</b>	<ul style="list-style-type: none"> <li>Washing gently</li> </ul> 	2.0			0:50
 <b>Allergy</b>	<ul style="list-style-type: none"> <li>For ticks and pollen</li> </ul> 	11.5	10.0	9.0	3:15
 <b>Mud</b>	<ul style="list-style-type: none"> <li>Mud stains</li> </ul> 	11.5	10.0	9.0	3:30
 <b>Tub Hygiene</b>	<ul style="list-style-type: none"> <li>Cleaning the drum.</li> </ul> 	None			3:45

- **Total time is approximate** (When the standard water supply rate is 15 L / min).  
For each program's default water temperature.









# Details of Programs

Program	Settings	Auto setting	
		Temp (°C)	Spin (r/min)
 <b>Daily Wash</b>		40	1200
 <b>Cotton</b>		40	1200
 <b>Baby Care</b>		40	1400
 <b>Active Speed 38</b>		40	1200
 <b>Bedding</b>		Cold	700
 <b>Delicates</b>		30	500
 <b>Allergy</b>		90	1200
 <b>Mud</b>		40	1200
 <b>Tub Hygiene</b>		40	1200

## NOTE

- For normally soiled laundry at the rated capacity, we recommend using the “Cotton, 60 °C, 1400 r/min” which is tested in accordance with IEC 60456 for the energy and water efficiency aspects.
- Actual water temperature may differ from the declared cycle temperature.
- These results depend on water pressure, water hardness, water inlet temperature, room temperature, type and amount of load, degree of soiling, utilized detergent, fluctuations in the main electricity supply and chosen additional options.



Setting range		Optional functions			
Temp (°C)	Spin (r/min)	Wash Mode	Timer	Rinse+	Auto Tub Care
Cold, 30, 40, 60	 , 500, 700, 1200, 1400	✓	✓	✓	✓
Cold, 30, 40, 60	 , 500, 700, 1200, 1400	✓	✓	✓	✓
Cold, 30, 40, 60	 , 500, 700, 1200, 1400	✓	✓	✓	✓
Cold, 30, 40	 , 500, 700, 1200, 1400	✓	✓	–	✓
Cold, 30	 , 500, 700	✓	✓	✓	–
Cold, 30, 40	 , 500	✓	–	✓	–
60, 90	 , 500, 700, 1200, 1400	–	✓	✓	✓
40	 , 500, 700, 1200, 1400	✓	✓	✓	✓
40	1200	–	–	–	–

 : Drain only (No spin)

# Washing Tips

## ECONAVI

- “Cotton” and “Daily Wash” programs

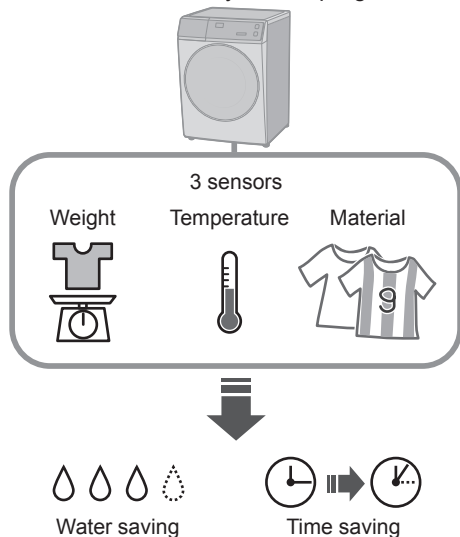

## ■ Lamp indications



Detecting



ECONAVI enabled



ECONAVI disabled

## Delicates

### ■ When washing

- To rinse fully, use the “Rinse+” function. (P. 23)

NOTE



Bleach



Liquid detergent for delicates

### ■ After operation ends



Take out immediately

## Bedding

### Washable items

- (Wash)
- (Handwash)
- 100 % cotton or 100 % synthetic

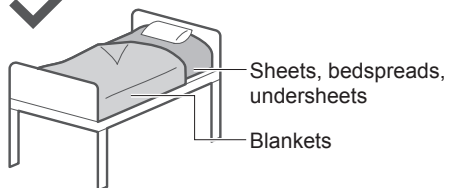

### Not washable items



Electric blankets



Wool



Silk



Long pile



Fake fur

### NOTE

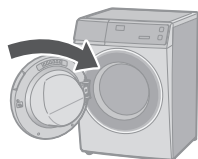

### Putting blankets into the drum

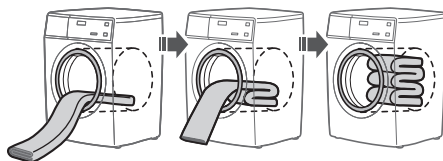
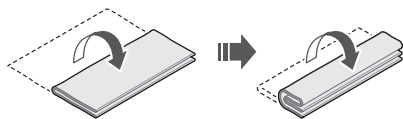

### NOTE

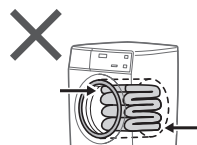
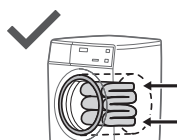

# Changing Program Settings

## ■ Preparing

- Sort the laundry and put it into the drum. (P. 7)
- Add the detergent. (P. 10)

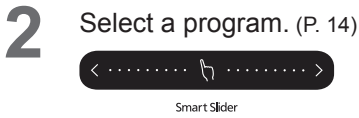

## **3** Change the program's settings.

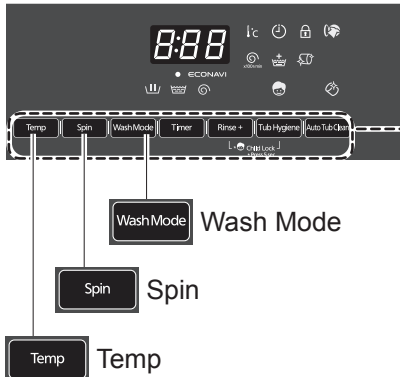

- Available options and setting ranges are different depending on the program. (P. 16)
- An alarm sounds if you select an option that is unavailable.







## Temp

Change the washing temperature.



## ■ Setting guide

Low	High
<ul style="list-style-type: none"> <li>● Colours</li> </ul> 	<ul style="list-style-type: none"> <li>● White</li> </ul> 
<ul style="list-style-type: none"> <li>● Lightly Soiled</li> </ul> 	<ul style="list-style-type: none"> <li>● Heavily Soiled</li> </ul> 
<ul style="list-style-type: none"> <li>● Easily shrinks</li> </ul>	<ul style="list-style-type: none"> <li>● Cotton</li> </ul>

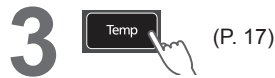

## r/min Spin



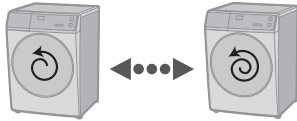

Change the spin speed.



Low

High

### ■ Setting guide

 <p>Low</p>	 <p>High</p>
<ul style="list-style-type: none"> <li>● To reduce wrinkling</li> </ul> 	<ul style="list-style-type: none"> <li>● To dry more thoroughly</li> </ul> 

# 3

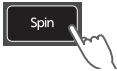

(P. 17)

### ■ To change the setting while washing









## Wash Mode

Select a combination of wash, rinse and spin.



# 3



 *1	Wash
 *2	Rinse
 *2	Spin
	Wash and rinse
	Wash and spin
 *2	Rinse and spin

\*1 Water is drained after wash process.

\*2 Drains first if there is water in the drum.

# Changing Program Settings (continued)

## ■ Preparing

- Sort the laundry and put it into the drum. (P. 7)
- Add the detergent. (P. 10)

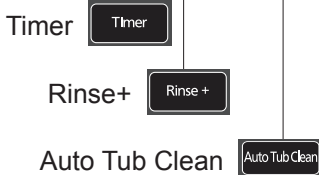
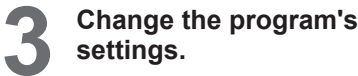
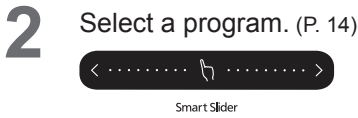

- Available options and setting ranges are different depending on the program. (P. 16)
- An alarm sounds if you select an option that is unavailable.



## Timer

Set how many hours later to finish operation. (Up to 24 hours)

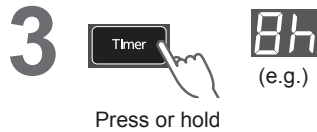
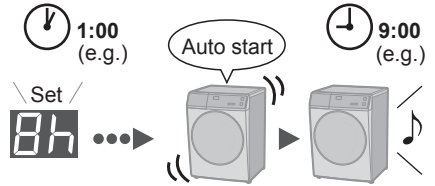

## ■ To check a preset time



## ■ To cancel settings

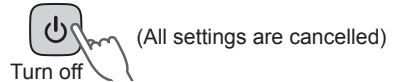

### NOTE

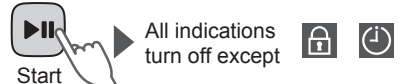

- Not available: P. 17

## Rinse+

Add an extra rinse.



3

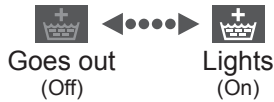

### ■ To change the setting while washing



1



2



3



## Auto Tub Clean

Add tub cleaning process.



3

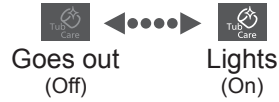

### NOTE

- The setting is memorized.

# Changing Appliance Settings

## Setting the Child Lock

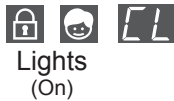
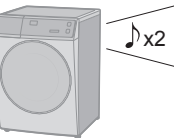
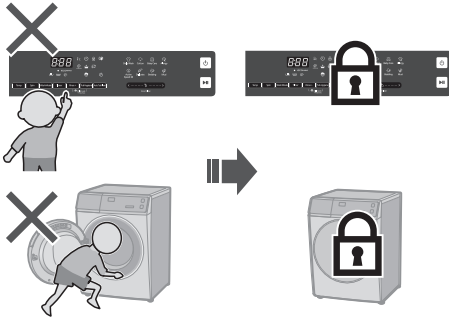

### ■ To cancel:

Same procedure  x4

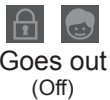

## Cancelling the buzzer

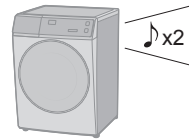

### ■ To reset:

Same procedure  x4





# Maintenance

## Water supply filter

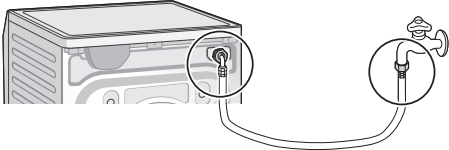
If water does not flow smoothly



**1**     
Empty

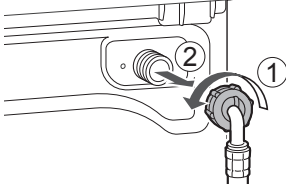

**6** 

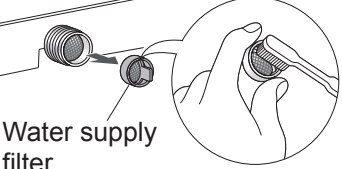
**2**    
On

**7**    
Water supply filter

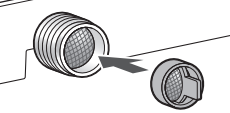

**3**  **Select**    
Daily Wash

**8** 

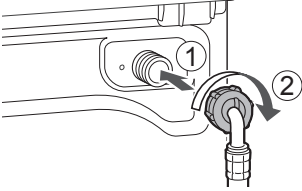
**4**  **Start**   
1 min.   
 **Turn off**

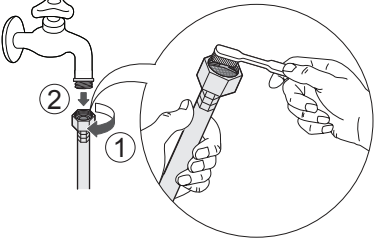
**9** 

**5** Remove and clean the filter   

**10**    

# Maintenance (continued)

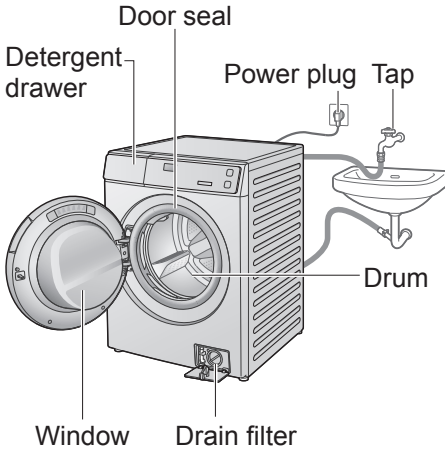

## Appliance

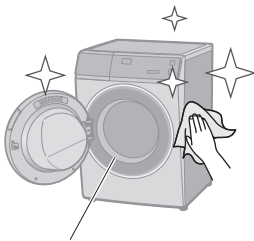

Door seal

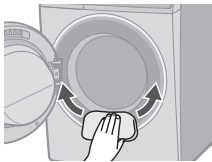

For heavy soil

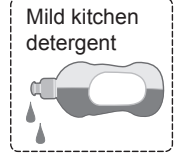

### NOTE

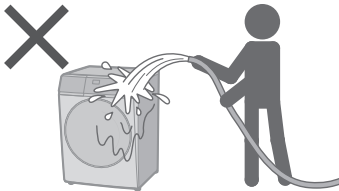

- Do not use gritty cleaners or thinners, or products containing alcohol or paraffin oil.

## Detergent drawer

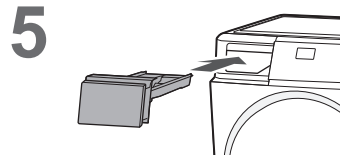
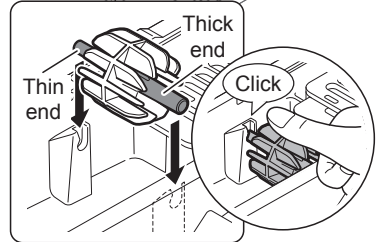
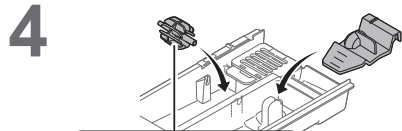
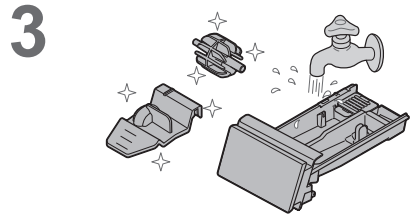
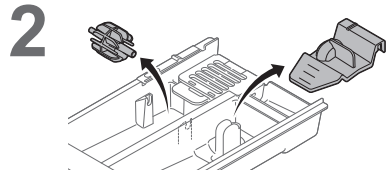
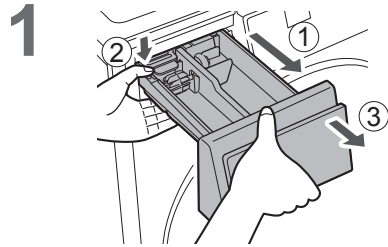

## Drum

Once a month or if  flashes  
<Tub Hygiene>

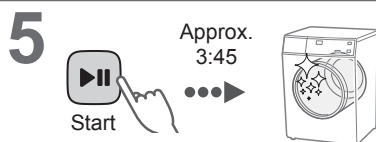
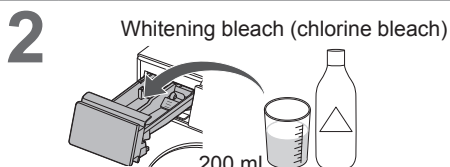

### NOTE

- If the “Tub Hygiene” program is not run, the indicator  goes off when other program is run 3 times.

# Maintenance (continued)

## Drain filter







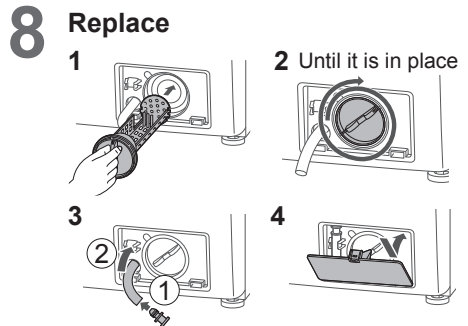
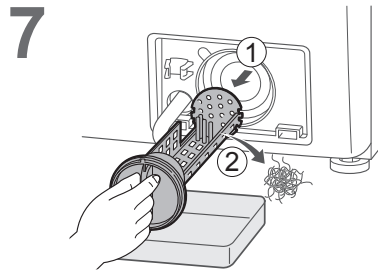
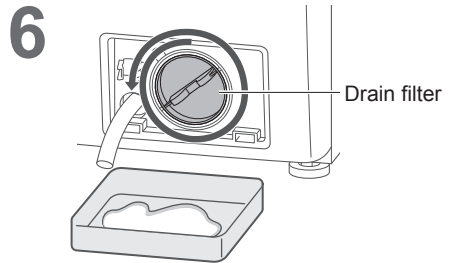
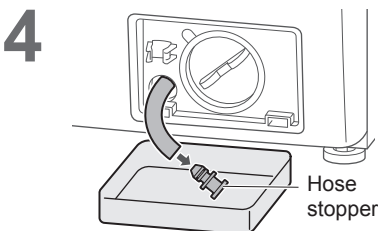
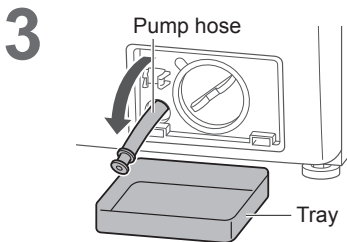
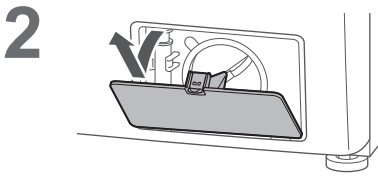
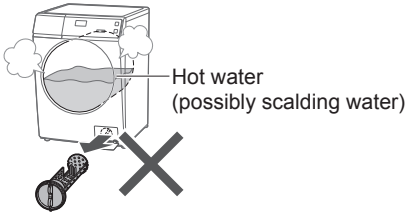

Once a month

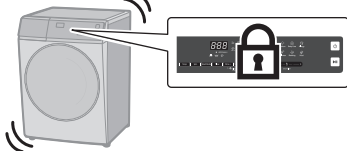
Be sure to drain water in the drum before this procedure.

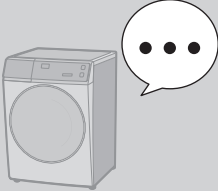

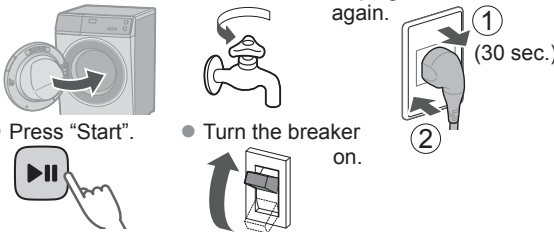

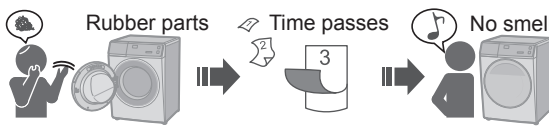
### CAUTION







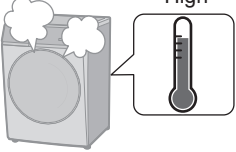

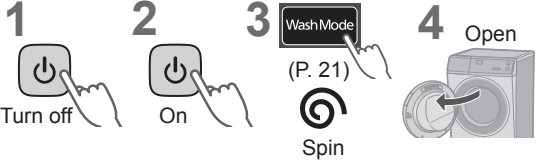
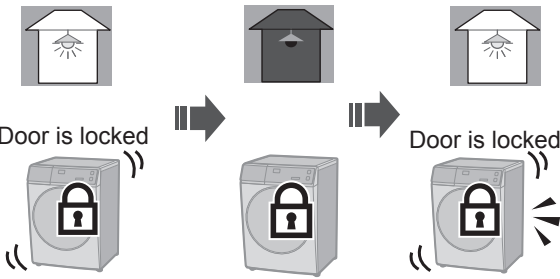

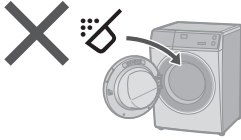
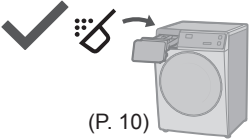
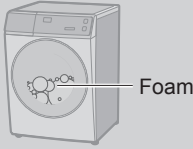

# Troubleshooting

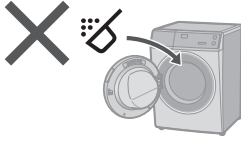
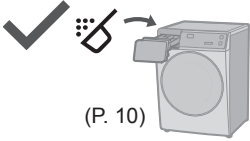
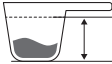

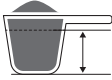

	Symptoms	Points to be checked
Main unit	<p>Touch the buttons</p> 	<p><input type="checkbox"/> Possible cause</p> <ul style="list-style-type: none"> <li>• During an operation</li> </ul>  <p><input type="checkbox"/> Try</p> <ul style="list-style-type: none"> <li>• Child Lock (P. 24)</li> </ul> 
	<p>No operation</p> 	<p><input type="checkbox"/> Check</p> <ul style="list-style-type: none"> <li>• Power cut</li> <li>• Timer</li> </ul>  <p><input type="checkbox"/> Try</p> <ul style="list-style-type: none"> <li>• Close the door.</li> <li>• Turn on.</li> <li>• Unplug and insert again.</li> <li>• Press "Start".</li> <li>• Turn the breaker on.</li> </ul> 
	<p>Odour of rubber</p> 	<p><input type="checkbox"/> Possible cause</p>  <p><input type="checkbox"/> Try</p> <p><b>Tub Hygiene</b> Tub Clean (P. 27)</p> 

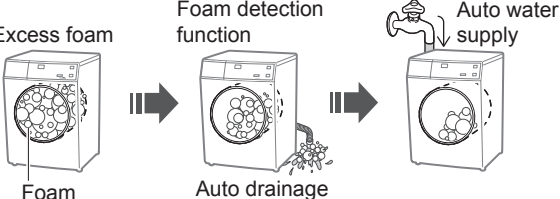
# Troubleshooting (continued)



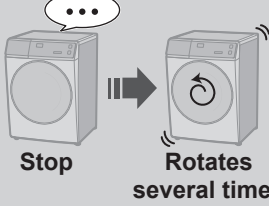
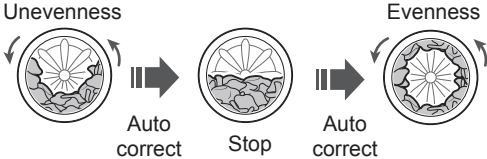
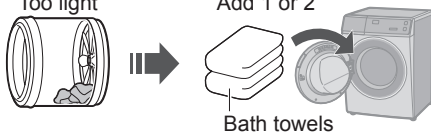
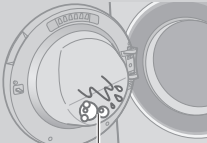
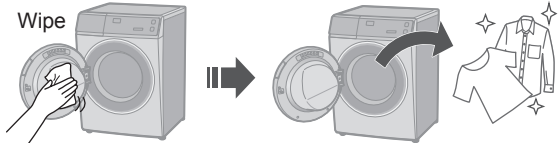

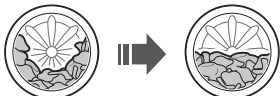

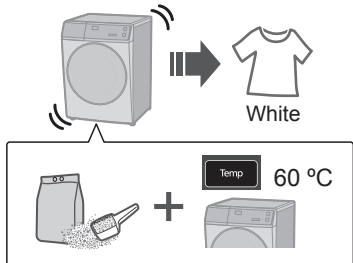

	Symptoms	Points to be checked
<p style="writing-mode: vertical-rl; transform: rotate(180deg);">Main unit</p> <p><b>Door does not open</b></p> 	<p>□ Possible cause</p> <ul style="list-style-type: none"> <li>● During an operation (washing or drying)</li> </ul>  <p>Door is locked. To open the door during operation (P. 12)</p> <p>□ Check</p> <ul style="list-style-type: none"> <li>● Temperature</li> <li>● Water level</li> </ul>  	<p>□ Try</p> <ul style="list-style-type: none"> <li>● Child Lock (P. 24)</li> </ul>  <ul style="list-style-type: none"> <li>● During an operation</li> </ul> <ol style="list-style-type: none"> <li>1 Turn off</li> <li>2 On</li> <li>3 Wash Mode (P. 21) Spin</li> <li>4 Open</li> </ol>  <p><b>NOTE</b></p> <p>Door is locked → Power cut → Restored → Door is locked</p> 

	Symptoms	Points to be checked
Detergent and foam	<b>After washing</b> 	<input type="checkbox"/> Check   (P. 10)
		<input type="checkbox"/> Possible cause <ul style="list-style-type: none"> <li>• The amount of foam varies.               <ul style="list-style-type: none"> <li>• Temperature</li> <li>• Water level</li> <li>• Water softness</li> </ul> </li> </ul>   
	<b>Not enough</b> 	<input type="checkbox"/> Check <ul style="list-style-type: none"> <li>• Powder detergent</li> </ul>   (P. 10) <ul style="list-style-type: none"> <li>• Too little detergent</li> <li>• Low foam detergent</li> <li>• Heavily soiled</li> <li>• Load too large</li> </ul>    
	<b>Too much</b> 	<input type="checkbox"/> Check <ul style="list-style-type: none"> <li>• Too much detergent</li> </ul> 
Wash	<b>During a wash</b> 	<input type="checkbox"/> Possible cause <ul style="list-style-type: none"> <li>Excess foam</li> <li>Foam detection function</li> <li>Auto water supply</li> </ul> 



# Troubleshooting (continued)

	Symptoms	Points to be checked
Rinse/Spin	<p>During the spin process</p>  <p><b>Stop</b> → <b>Rotates several times</b></p>	<p><input type="checkbox"/> Possible cause</p> <p>Unevenness</p>  <p>Auto correct → Stop → Auto correct</p> <p>Evenness</p> <p><input type="checkbox"/> Try</p> <p>Too light</p>  <p>Add 1 or 2 Bath towels</p>
	<p>After washing</p>  <p><b>Foam or water</b></p>	<p><input type="checkbox"/> Try</p>  <p>Wipe</p>
Laundry	<p>Spin changes to rinse</p>  <p>Spin → Rinse</p>	<p><input type="checkbox"/> Possible cause</p> <ul style="list-style-type: none"> <li>If clothes are uneven, this appliances automatically corrects unevenness using the rinse process.</li> </ul> 
	<p>If the laundry yellows</p>  <p>Yellow</p>	<p><input type="checkbox"/> Try</p>  <p>White</p> <p>Temp 60 °C</p>





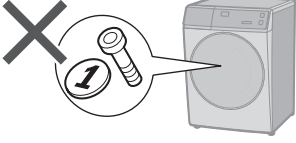
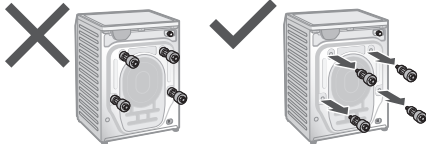
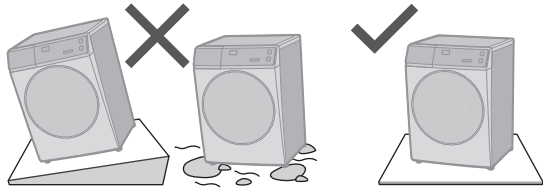
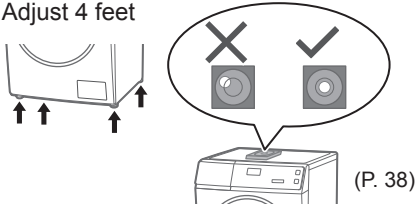

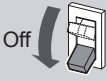
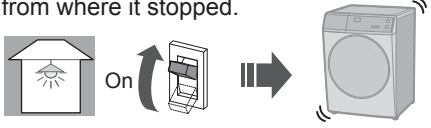





























	Symptoms	Points to be checked
Time	<p><b>During a wash</b></p> <p>Displayed time</p>  <p>Changes</p> 	<p><input type="checkbox"/> Possible cause</p> <ul style="list-style-type: none"> <li>● Remaining time is corrected during operation.</li> </ul>  <ul style="list-style-type: none"> <li>● If the settings changed</li> <li>● If clothes are uneven</li> </ul>   <p>➡ The remaining time may increase.</p>
	<p><b>During water drainage</b></p> 	<p><input type="checkbox"/> Possible cause</p> <ul style="list-style-type: none"> <li>● This is normal. The drain pump is working.</li> </ul>
	<p><b>During spin process</b></p> 	<p><input type="checkbox"/> Possible cause</p> <ul style="list-style-type: none"> <li>● This is normal. Anti-foam leak part is working at the exhaust port.</li> </ul>
	<p><b>Sound of fan rotating</b></p> 	<p><input type="checkbox"/> Possible cause</p> <ul style="list-style-type: none"> <li>● This is normal. The drain pump is working.</li> </ul>
	<p><b>Motor emits a sound</b></p> 	<p><input type="checkbox"/> Possible cause</p> <ul style="list-style-type: none"> <li>● This is normal. The motor will make a short sound when the drum engages.</li> </ul>

# Troubleshooting (continued)

	Symptoms	Points to be checked
<b>Noise</b>	<p><b>Unusual noise (or vibration)</b></p> 	<p><input type="checkbox"/> Check</p> <ul style="list-style-type: none"> <li>● Metal items            </li> <li>● Anchor bolts (P. 38)            </li> <li>● Slope or an unstable surface            </li> <li>● Adjust 4 feet            </li> </ul>
<b>Others</b>	<p><b>Power cut</b></p>  <p><b>Breaker</b></p> <p>Off </p>	<p><input type="checkbox"/> Check</p> <ul style="list-style-type: none"> <li>● When the power recovers, operation resumes from where it stopped.</li> </ul> 

# Error Display

Error Display	Points to be checked
<p>U 11</p> <p>Unable to drain</p>	<p>1 Check </p> <p>2 </p> <p>3  Start</p> <div style="border: 1px solid black; padding: 5px; display: flex; justify-content: space-around; align-items: center;"> <span>✗ </span> <span>✗ </span> <span> Lint</span> <span>✗ </span> <span>✗  (P. 28)</span> </div>
<p>U 12</p> <p>Door is open</p>	<p>1 </p> <p>2  Start</p>
<p>U 13</p> <p>Unable to spin / dry</p>	<p>1 </p> <p>2 Check</p> <p>3   Start</p> <div style="border: 1px solid black; padding: 5px; display: flex; justify-content: space-between;"> <div style="text-align: center;"> <p>Uneven</p>  </div> <div style="text-align: center;"> <p>Even</p>  </div> <div style="text-align: center;"> <p>Unstable or inclined</p>  </div> <div style="text-align: center;"> <p>Stable</p>  </div> <div style="text-align: center;"> <p>Too much</p>  </div> <div style="text-align: center;"> <p>Reduce</p>  </div> <div style="text-align: center;"> <p>Too little</p>  </div> <div style="text-align: center;"> <p>Add</p>  </div> </div>
<p>U 14</p> <p>Unable to supply water</p>	<p>1 Check</p> <p>2 </p> <p>3  Start</p> <div style="border: 1px solid black; padding: 5px; display: flex; justify-content: space-around;"> <div style="text-align: center;"> <p>Water outage</p>  </div> <div style="text-align: center;"> <p>Turned off</p>  </div> <div style="text-align: center;"> <p>Water supply filter (P. 25)</p>  </div> </div>
<p>U 17</p> <p>Unable to spin</p>	<p>1 Restart  Turn off  On</p> <p>2 Run "Active Speed 38" </p> <div style="border: 1px solid black; padding: 5px; display: flex; align-items: center;"> <p>• Next time:</p> <div style="margin-left: 20px;">  </div> <div style="margin-left: 20px;">  </div> <div style="margin-left: 20px;"> <p>Low foam detergent</p> </div> </div>
<p>H 00</p>	<p>1 </p> <p>2 </p> <p>3 </p>

# Installation **Choosing the Right Location**



**Make sure to ask a service person for installation.**

- Do not install the appliance by yourself.
- Follow this installation method. If you do not, Panasonic will not be liable for any accidents or damages.

## Appliance dimensions

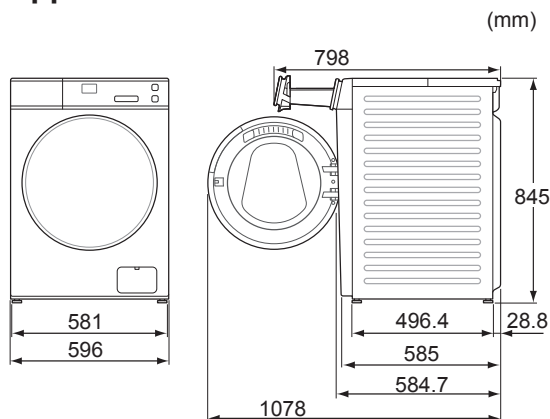

## ■ Set-in installation

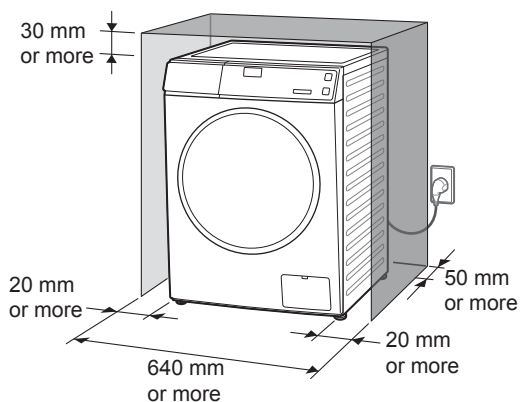

- Do not let the metallic portions of the appliance come into contact with metal sinks or other appliances.

## Check the location.

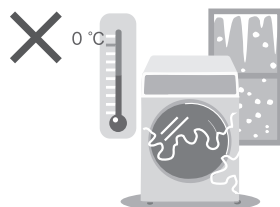
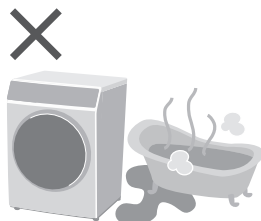

# Installation **Moving and Installing**

## Carrying the appliance

Do not do it alone.

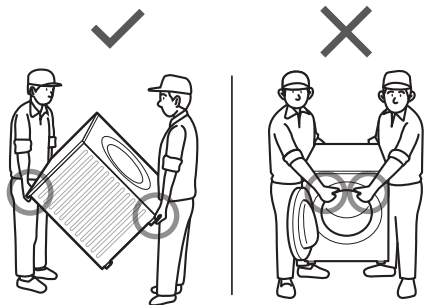

## Installation of bottom cover

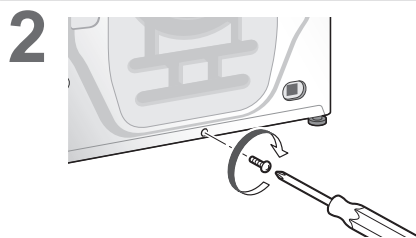
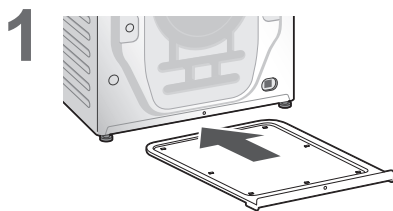

# Installation **Moving and Installing** (continued)

## Removing the anchor bolts

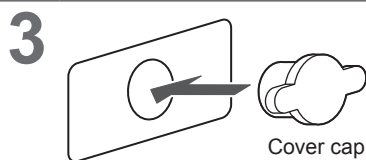
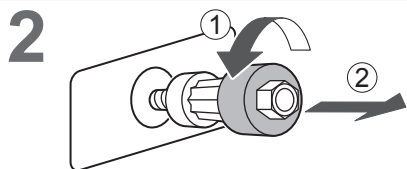
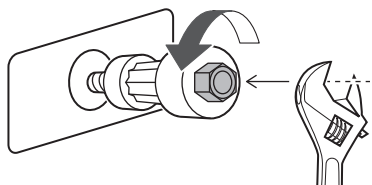
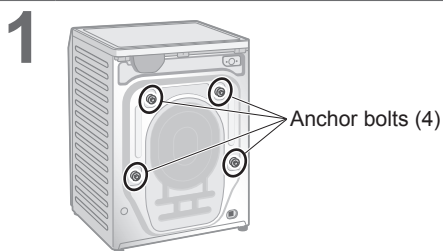

NOTE

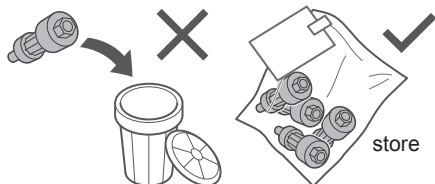

### ■ Moving the appliance again

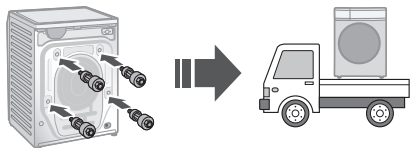

## Levelling the appliance

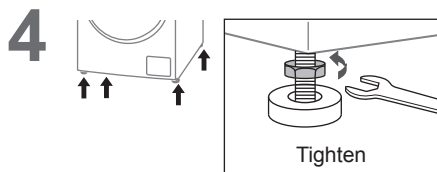
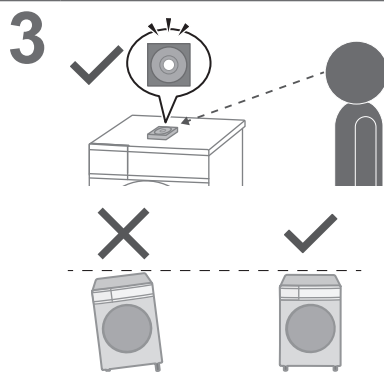
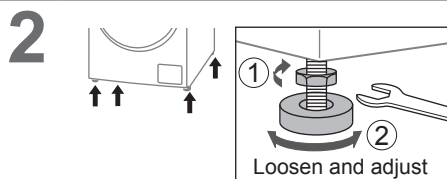
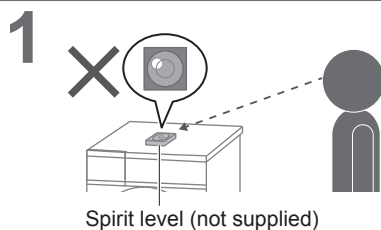

NOTE

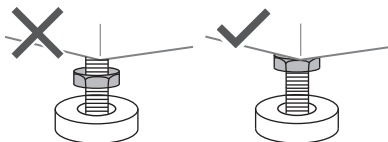

# Installation **Connecting the Hoses**

Connect the hoses properly to prevent water leaks.

## Maximum connection distances for hoses and the power cord

### Right side connection

(cm)

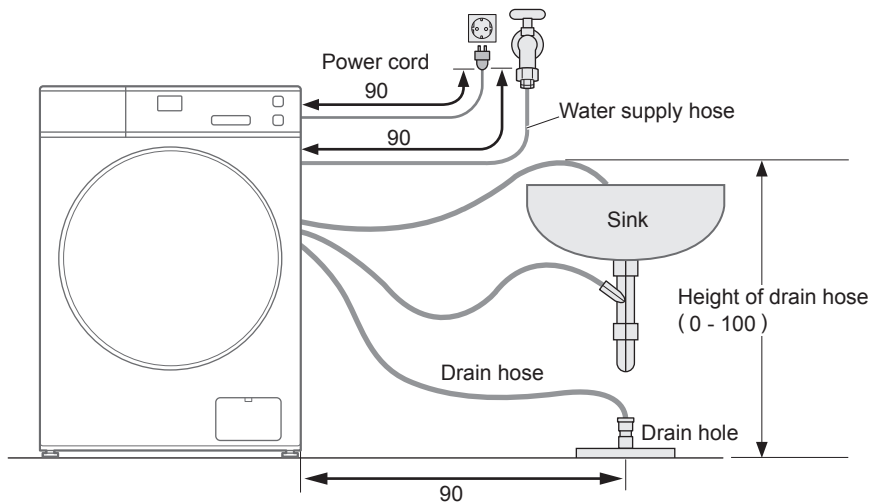

### Left side connection

(cm)

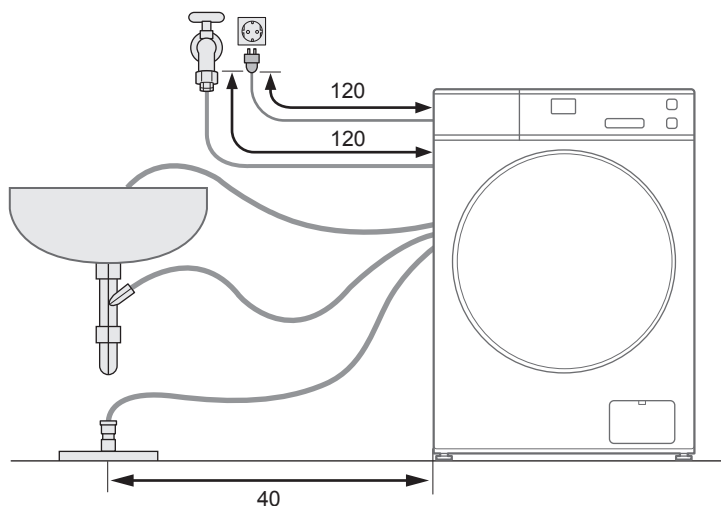

# Connecting the Hoses (continued)

## Water supply hose

### ■ Connecting the water supply hose

**⚠ CAUTION**

- Tighten the nut firmly.
- Do not twist, squash, modify or cut the hose.

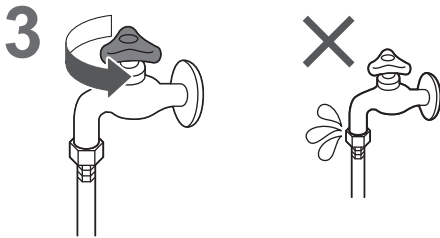
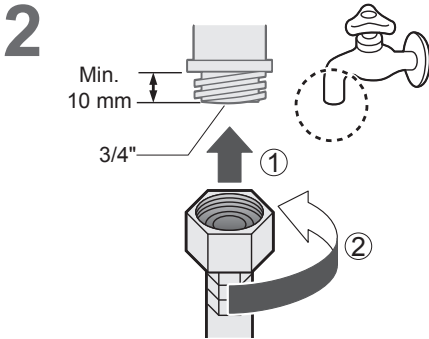
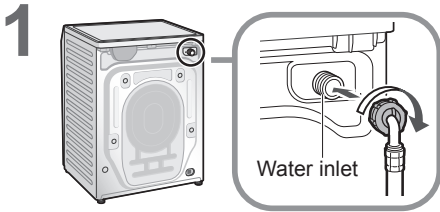

## Drain hose

### ■ Draining to a sink or wash basin

**NOTICE**

### ■ Draining to a stand pipe

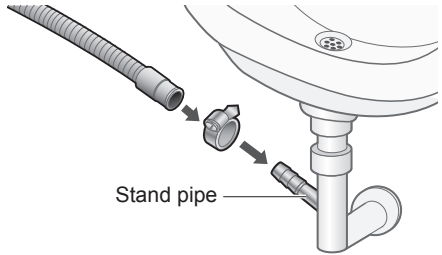

### ■ Draining to a drain hole

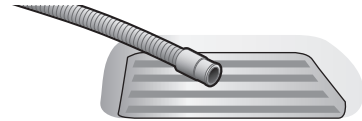





**NOTE**

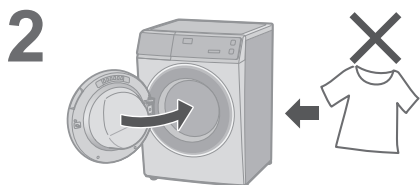

# Installation Test Run

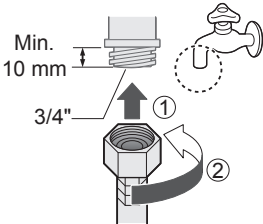

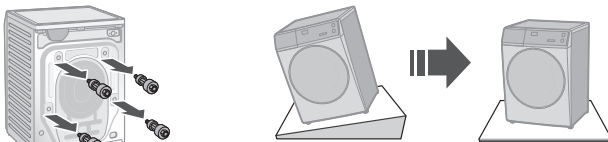
## Checking after test run

Problem	Causes and Measures
<p><b>Water leaks</b></p> 	<p>Connect the water supply hose properly</p> 
<p><b>Abnormal sounds</b></p> 	<ul style="list-style-type: none"> <li>● Remove the anchor bolts (P. 38)</li> <li>● Install stably</li> </ul> 
<p><b>Error display</b></p> 	<p>See P. 35.</p>

# Specifications

	NA-V115FA1	NA-V10FA1	NA-V90FA1
Rated voltage (V)	220 - 240		
Rated frequency (Hz)	50		
Maximum energy rated power input (W)	1600 - 1900		
Heating energy rates power input (W)	1445 - 1710		
Maximum spin speed (r/min)	1400		
Product dimensions (W x D x H) (mm)	596 × 585 × 845		
Product weight (kg)	68		
Maximum mass of dry cloth (Wash) (kg)	11.5	10.0	9.0
Pressure of tap water (MPa)	0.01 - 1		



