

Panasonic®

Operating Instructions (Household use) Rechargeable Shaver Model No. ES-LV97

Contents

Safety precautions	2	Replacing the cleaning liquid...	18
Important information	7	When the LOW/STATUS lamp glows	19
Parts identification	9	FAQ	20
Preparation	10	Troubleshooting	20
How to use	12	Battery life	25
Cleaning thoroughly	15	Removing the built-in rechargeable battery	26
Replacing the system outer foil and the inner blades	17	Specifications	27



Thank you for purchasing this Panasonic product.

Before operating this unit, please read these instructions completely and save them for future use.

Safety precautions

To reduce the risk of injury, loss of life, electric shock, fire, and damage to property, always observe the following safety precautions.

Explanation of symbols

The following symbols are used to classify and describe the level of hazard, injury, and property damage caused when the denotation is disregarded and improper use is performed.



DANGER

Denotes a potential hazard that will result in serious injury or death.



WARNING

Denotes a potential hazard that could result in serious injury or death.



CAUTION

Denotes a hazard that could result in minor injury or property damage.

The following symbols are used to classify and describe the type of instructions to be observed.



This symbol is used to alert users to a specific operating procedure that must not be performed.



This symbol is used to alert users to a specific operating procedure that must be followed in order to operate the unit safely.



WARNING

► This product

This product has a built-in rechargeable battery.

Do not throw into fire, apply heat, or charge, use, or leave in a high temperature environment.

- Doing so may cause overheating, ignition, or explosion.

Do not modify or repair.

- Doing so may cause fire, electric shock, or injury.

Contact an authorized service center for repair (battery change etc).

Never disassemble except when disposing of the product.

- Doing so may cause fire, electric shock, or injury.

WARNING

▶ In case of an abnormality or malfunction

Immediately stop using and remove the adaptor if there is an abnormality or malfunction.

- Failure to do so may cause fire, electric shock, or injury.

<Abnormality or malfunction cases>



• The main unit, self-cleaning recharger, adaptor or cord is deformed or abnormally hot.

• The main unit, self-cleaning recharger, adaptor or cord smells of burning.

• There is an abnormal sound during use or charging of the main unit, self-cleaning recharger, adaptor or cord.

- Immediately request inspection or repair at an authorized service center.

▶ Power supply



Do not connect or disconnect the adaptor to a household outlet with a wet hand.

- Doing so may cause electric shock or injury.

Do not immerse the AC adaptor and the self-cleaning recharger in water or wash with water. Do not place the AC adaptor and the self-cleaning recharger over or near water filled sink or bathtub.



Never use the appliance if the AC adaptor is damaged or if the power plug fits loosely in a household outlet.

Do not damage the cord or the power plug.

• Do not deface, modify, forcefully bend or pull the cord or the power plug. Also, do not place anything heavy on, twist or pinch the cord.

- Doing so may cause electric shock or fire due to a short circuit.

Do not use in a way exceeding the rating of the household outlet or the wiring.



- Exceeding the rating by connecting too many plugs to one household outlet may cause fire due to overheating.

Do not use anything other than the supplied AC adaptor and the self-cleaning recharger for any purpose.



Also, do not use any other product with the supplied AC adaptor and the self-cleaning recharger. (See page 9.)

- Doing so may cause burn or fire due to a short circuit.



WARNING

Always ensure the appliance is operated on an electric power source matched to the rated voltage indicated on the AC adaptor. Fully insert the adaptor.

- Failure to do so may cause fire or electric shock.



Disconnect the AC adaptor when cleaning the main body with water.

- Failure to do so may cause electric shock or injury.



Regularly clean the power plug and the appliance plug to prevent dust from accumulating.

- Failure to do so may cause fire due to insulation failure caused by humidity.

► Preventing accidents

Persons using an implanted medical electronic device, such as a pacemaker, should not allow this unit to touch the skin where the medical electronic device is implanted.

- Doing so may cause an accident or illness.



Do not place within reach of children or infants. Do not let them use it.

- Putting parts or accessories in the mouth may cause an accident or injury.



Do not use or store the self-cleaning recharger on top of other electrical devices.

- Doing so may cause electric shock due to liquid spill or fire due to a short circuit.

If detergent or oil is consumed accidentally, do not induce vomiting, drink a large amount of water and contact a physician.



If detergent or oil comes into contact with eyes, wash immediately and thoroughly with running water and contact a physician.

- Failure to follow these instructions may result in physical problems.

If detergent contacts skin, wash immediately and thoroughly with soap.



If you experience skin irritation anywhere on the body, stop using immediately and contact a physician.

- Failure to follow these instructions may result in physical injury or injury to the skin.

► Note the following precautions

This appliance is not intended for use by persons (including children) with reduced physical, sensory or mental capabilities, or lack of experience and knowledge, unless they have been given supervision or



instruction concerning use of the appliance by a person responsible for their safety. Children should be supervised to ensure that they do not play with the appliance.

- Failure to do so may cause an accident or injury.

WARNING

The supply cord cannot be replaced. If the cord is damaged, the AC adaptor should be scrapped.



- Failure to do so may cause an accident or injury.

CAUTION

► Protecting the skin

Do not use excessive pressure to apply the system outer foil to your lip or other part of your face.



Do not apply the system outer foil directly to blemishes or injured skin.

Do not touch the blade section (metallic section) of the inner blade.

- Doing so may cause injury to skin or hand.

Do not forcefully press the system outer foil. Also, do not touch the system outer foil with fingers or nails when in use.



Do not use this product for hair on head or any other part of the body.

- Doing so may cause injury to skin or reduce the life of the system outer foil.

Do not remove the shaver from the self-cleaning recharger while using the “AUTO” mode or “Dry/Charge” mode.



- Doing so may cause burn due to high temperatures around the blades.



Check the system outer foil for cracks or deformations before use.

- Failure to do so may cause injury to the skin.



Be sure to place the protective cap on the shaver when carrying around or storing.

- Failure to do so may cause injury to skin or reduce the life of the system outer foil.

► Note the following precautions

Do not wrap the cord around the adaptor when storing.



- Doing so may cause the wire in the cord to break with the load, and may cause fire due to a short circuit.

Do not allow metal objects or trash to adhere to the power plug or the appliance plug.



- Doing so may cause electric shock or fire due to a short circuit.

Do not disconnect the adaptor or the appliance plug by holding onto the cord.



- Doing so may cause electric shock or injury.

Do not share your shaver with your family or other people.





- Doing so may result in infection or inflammation.

CAUTION

 **Do not drop or hit against other objects.**
- Doing so may cause injury.

 **Do not use detergent for any purpose other than washing the shaver blades.**
- Using it with other products may cause discoloration or cracking.

 **Immediately wipe up any cleaning liquid that has been spilt.**
- Prolonged contact may cause discoloration of leather products or wooden floors.

 **Disconnect the adaptor from the household outlet when not charging.**
- Failure to do so may cause electric shock or fire due to electrical leakage resulting from insulation deterioration.

 **Use caution when opening detergent as spout is sharp.**
- Failure to do so may cause injury.

Handling of the removed battery when disposing

DANGER

- The rechargeable battery is exclusively for use with this appliance. Do not use the battery with other products.
- Do not charge the battery after it has been removed from the product.
- Do not throw into fire or apply heat.
- Do not hit, disassemble, modify, or puncture with a nail.
- Do not let the positive and negative terminals of the battery get in contact with each other through metallic objects.
- Do not carry or store the battery together with metallic jewellery such as necklaces and hairpins.
- Do not use or leave the battery where it will be exposed to high temperatures, such as under direct sunlight or near other sources of heat.
- Never peel off the tube.
- Doing so may cause overheating, ignition, or explosion.



WARNING

After removing the rechargeable battery, do not keep it within reach of children and infants.



- The battery will harm the body if accidentally swallowed.

If this happens, consult a physician immediately.

If the battery fluid leaks out and comes in contact with the eyes, do not rub the eyes, and thoroughly rinse with clean water, such as tap water.



- Failure to do so may cause eye injury.

Consult a physician immediately.



CAUTION

If the battery fluid leaks out and comes in contact with the skin or clothes, rinse off with clean water, such as tap water.



- Failure to do so may cause inflammation.

Important information

- This WET/DRY shaver can be used for wet shaving using shaving lather or for dry shaving. You can use this watertight shaver in the shower and clean with water. The following symbol means suitable for use in a bath or shower.



- Treat yourself to wet lather shaves for at least three weeks and notice the difference. Your Panasonic WET/DRY shaver requires a little time to get used to because your skin and beard need about a month to adjust to any new shaving method.
- Do not bring the system outer foil into contact with hard objects.
Doing so may damage the blades as they are very thin and deform easily.
- Do not dry the main unit with a dryer or a fan heater.
Doing so may cause malfunction or deformation of the parts.
- Do not leave the shaver exposed to direct sunlight with the foil frame detached.
Doing so may deteriorate the waterproof rubber and degrade waterproof function, which may cause to malfunction.
- Store the shaver in a place with low humidity after use.
Failure to do so may cause malfunction due to condensation or rust.

- Do not leave the detergent in location of high temperatures.
Doing so may cause deterioration.
- Keep both the inner blades inserted. If only one of the inner blades is inserted, the shaver may be damaged.
- If you clean the shaver with water, do not use salt water or hot water. Do not soak the shaver in water for a long period of time.
- The following symbol indicates that a specific detachable power supply unit is required for connecting the electrical appliance to the supply mains. The type reference of power supply unit is marked near the symbol.



Parts identification

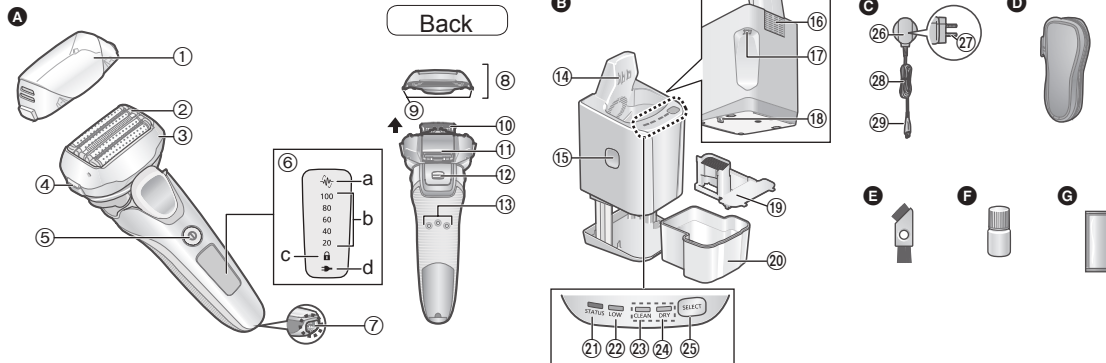

A Main body

- ① Protective cap
- ② System outer foil
- ③ Foil frame
- ④ Foil frame release buttons
- ⑤ Power switch
- ⑥ Lamp display
 - a. Shaving sensor lamp (i)
 - b. Battery capacity lamp
 - c. Switch lock lamp (🔒)
 - d. Charge status lamp (➡)
- ⑦ Appliance socket
- ⑧ Outer foil section

- ⑨ System outer foil release buttons

- ⑩ Inner blades
- ⑪ Trimmer
- ⑫ Trimmer handle
- ⑬ Main body rear terminals

B Self-cleaning recharger (RC9-22)

- ⑭ Charging terminals
- ⑮ Cleaning liquid unit removal button
- ⑯ Intake port
- ⑰ Self-cleaning recharger socket
- ⑱ Lock release lever
- ⑲ Cleaning liquid filter
- ⑳ Cleaning liquid unit

- ㉑ STATUS lamp
- ㉒ LOW lamp
- ㉓ CLEAN lamp
- ㉔ DRY lamp
- ㉕ SELECT button

C AC adaptor (RE7-87)

- ㉖ Adaptor
- ㉗ Power plug
- ㉘ Cord
- ㉙ Appliance plug

Accessories

- ⓓ Travel case
- ⓔ Cleaning brush
- ⓕ Oil
- ⓖ Special detergent (Detergent)

There may be water droplets inside the self-cleaning recharger at the time of purchase, but there is no problem regarding the hygiene or the performance. (It is a residue of the distilled water used for performance test.)

Preparation

Charging the shaver

- Turn the shaver off.
- Wipe off any water droplets on the main body rear terminals.

1 Insert the appliance plug into the self-cleaning recharger.

2 Remove the protective cap while pressing the side of the cap and insert the shaver into the self-cleaning recharger.

- Slowly insert the shaver into the self-cleaning recharger taking care not to damage the system outer foil.

3 Plug the adaptor into a household outlet.

- Check that the charge status lamp (➡) is glowing.
- Charging is completed after approx. 1 hour.

4 Disconnect the adaptor after charging is completed.

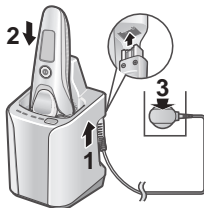

While charging

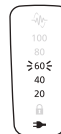

➡ glows.

The number of the battery capacity lamp will increase as charging progresses.

After charging is completed

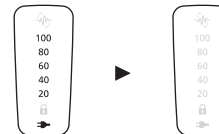

All the battery capacity lamp and ➡ will glow and then turn off after 5 seconds.

Notes

- When charging the shaver for the first time or when it has not been in use for more than 6 months, the charging time may change or the charge status lamp (➡) may not glow for a few minutes. It will eventually glow if kept connected.
- Recommended ambient temperature for charging is 10 °C – 35 °C. It may take longer to charge, or the charge status lamp (➡) will blink quickly and the battery may fail to charge properly in extremely high or low temperatures.
- The shaver can be used for approximately 2 weeks with a full charge.
(Based on one 3-minute dry-shave usages per day in an ambient temperature range of 20 °C – 30 °C.)
The number of usable days varies depending on the following conditions.
 - Beard thickness
 - Pressure applied to the skin
 - Usage frequency of the sonic vibration cleaning mode

- If there is noise from the radio or other sources while using or charging the appliance, move to a different location to use the appliance.

Charging without the self-cleaning recharger

- Turn the shaver off.
- Wipe off any water droplets on the appliance socket.

- 1 Insert the appliance plug into the shaver.**
- 2 Plug the adaptor into a household outlet.**
- 3 Disconnect the adaptor after charging is completed.**

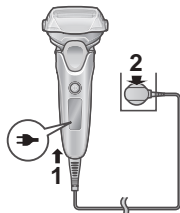

Note

You cannot operate the shaver while charging.

Preparing the cleaning liquid

Cleaning can start right after the usage by preparing in advance.

(See page 14.)

- Remove the AC adaptor from the self-cleaning recharger.

- 1 Press the cleaning liquid unit removal button (1) and remove the cleaning liquid unit (2) on a hard, flat surface.**

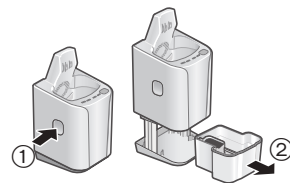

- When the self-cleaning recharger is lifted, or on the soft surface such as carpets, the lock release lever will not fit in the recharger properly. In that case, the cleaning liquid unit cannot be removed.

- 2 Pour tap water (1) and detergent (2) into the cleaning liquid unit.**

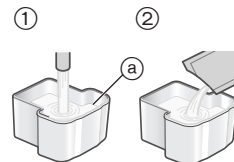

- Be careful not to let the water rise above the maximum water line (a).
- Pour the entire packet of detergent.

- 3 Slowly insert the cleaning liquid unit into the self-cleaning recharger until it clicks.**

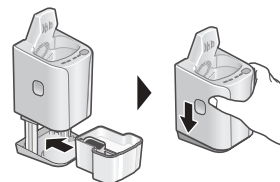

Notes

- To replace the cleaning liquid, see page 18.

- Only use self-cleaning recharger detergent for Panasonic shavers.
Not doing so may cause malfunction or failure.
- Do not tilt the self-cleaning recharger.
Doing so may cause spill or the number of days that cleaning liquid can be used reduce.
- You can use the cleaning liquid for approximately 30 days if used once per day.
(This will differ depending on beard thickness and the ambient temperature.)

How to use

Shaving beard

1 Press and shave.

- The “shaving sensor”, which automatically adjusts the power depending on the beard thickness, will operate.

It will shave with high power on areas where the beard is heavy, and reduce the power on areas where the beard is thin, to reduce burden on the skin.



Tips for better shaving

Apply the whole system outer foil perpendicularly against the skin and shave by slowly gliding the shaver over the face against the grain of the beard.



- The beard under the chin and around the throat can be shaved better by stretching the skin so the beard will stand.
- To prevent damaging the system outer foil, do not shave with only a part of the system outer foil.

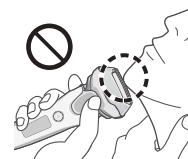

2 Press when finished.

While using

The remaining battery capacity are shown and then turn off after 5 seconds.

- Approximate amount of battery capacity is displayed as 20 - 100.
- The shaving sensor lamp () blinks.

After use

The remaining battery capacity blink and then turn off after 5 seconds.

When the battery capacity is low "20" blinks when operating the shaver.

- You can shave 2 to 3 times after "20" blinks. (This will differ depending on usage.)

Notes

- The appliance may not operate in an ambient temperature lower than approximately 5 °C.
- The shaving sensor may not respond depending on the type and quantity of the shaving gel. This is not abnormal.
- Depending on the beard thickness or the amount of beard trimmings in the shaver head, the shaving sensor may not react and the driving sound may not change. This is not abnormal.

- To prevent erroneous operation, place your fingers on the finger rest while using the shaver.
- The sonic vibration cleaning mode is activated when the power switch is pressed for more than 2 seconds while the shaver is not operating. (See page 15.) You cannot shave in this mode.

Operation and display of the switch lock

► Locking the power switch

<p>1. Press () once and then release.</p> <ul style="list-style-type: none"> • The shaver starts operating. 	<p>2. Press () for more than 2 seconds until the switch lock lamp () turns on.</p> <ul style="list-style-type: none"> • The shaver will stop operating. 	<p>3. Release ().</p> <ul style="list-style-type: none"> • The switch lock lamp () will light up for 5 seconds and turn off.
---	--	---

► Unlocking the power switch

<p>1. Press () for more than 2 seconds until the switch lock lamp () turns off.</p>	<p>2. Once the shaver starts operating, release ().</p> <ul style="list-style-type: none"> • The switch lock lamp () will turn off.
---	--

- The power switch is locked when the switch lock lamp (🔒) blinks for 5 seconds and the shaver does not operate even though the power switch is pressed.

► Switching the shaver head

You can change the pivot action.

FREE

The shaver head is moved to prevent missed spots.



LOCK

You can lock the shaver head.



► Using the trimmer

1. Slide the trimmer handle up to the "mm" position so that the trimmer stands upright.
2. Press (i) and use.

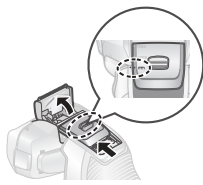

Press and hold the top knob (a) and slide the trimmer handle down to lower the trimmer.



Tips for better usage

Apply the trimmer edge perpendicular to skin gently and move downward slowly.

Trimming sideburns

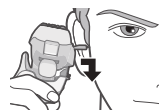

Pre-shave of long beards



Cleaning, drying, charging

We recommend cleaning the shaver after each use.

- 1 **Insert the shaver into the self-cleaning recharger and plug the adaptor into a household outlet. (See page 10.)**

- Check that the charge status lamp (➡) is glowing.
- When the LOW lamp or the STATUS lamp lights up, see page 19.

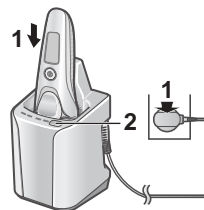

- 2 **Press (SELECT).**

The CLEAN lamp and the DRY lamp glow, and the "AUTO" mode will start after approximately 6 seconds.

- It is not possible to change the mode after the "AUTO" mode has started.



*When the ambient temperature of the self-cleaning recharger is low (approx. 15 °C or lower), the drying process will take up to 170 min.

3 Remove the adaptor after the selected mode is completed.

Clean the shaver with water or with the cleaning brush once per month. (See pages 15 to 17.)

The main unit neck section (a), inner blade attachment part (b), trimmer, system outer foil gaps, etc. cannot be cleaned with the self-cleaning recharger.

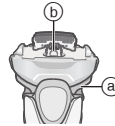

Changing the mode of self-cleaning recharger

The “Charge” mode starts when attaching the shaver, and the mode can be changed by pressing the SELECT button.

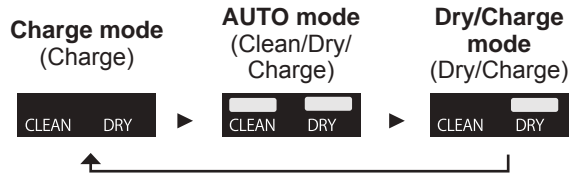

Notes

- Do not press the cleaning liquid unit removal button during cleaning as the cleaning liquid may spill causing a malfunction.

- The drying time may increase in an ambient temperature approximately 15 °C or lower. The Clean or Dry function may not operate under extreme low temperatures (approximately 0 °C or lower).
- A lubricant constituent is included in the detergent, so smooth shave is maintained without applying oil.

Cleaning thoroughly

Cleaning with water

- Turn the shaver off and disconnect the AC adaptor.

1 Apply some hand soap and some water to the system outer foil.



2 Press for more than 2 seconds to activate the sonic vibration cleaning mode.

- Splashing of foam is suppressed.
- The battery capacity lamps blink in order.
- After about 20 seconds, it will be automatically turned off, or you can turn it off by pressing the power switch.

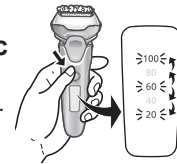

3 Remove the outer foil section and clean with running water.

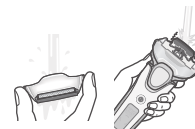

- See page 17 for removing the outer foil section.
- Splashing is reduced by rinsing the shaver in sonic vibration cleaning mode.
- After rinsing with water, shake the shaver up and down for a few times to remove excess moisture and then wipe off any drops of water with a dry cloth.

4 Attach the outer foil section and dry with the self-cleaning recharger.

1. Insert the shaver into the self-cleaning recharger and plug the adaptor into a household outlet.

- Check that the charge status lamp (▶) is glowing.

2. Press **SELECT** twice.

The DRY lamp glows, and the “Dry/Charge” mode will start after approximately 6 seconds.

- It is possible to change to the “AUTO” mode even after the “Dry/Charge” mode has started.



3. Remove the adaptor after the selected mode is completed.

5 Lubricate the shaver.

It will keep the movement of the blade smooth and maintain a comfort shave.

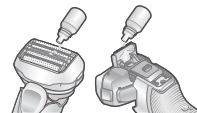
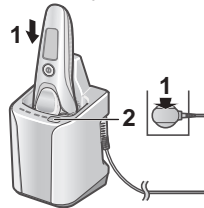

1. Apply one drop of oil to each of the system outer foils.
2. Raise the trimmer and apply a drop of oil.
3. Switch the shaver on, and run it for approximately five seconds.
4. Switch off the shaver, and wipe off any excess oil from the system outer foil with a soft cloth.

► Drying the shaver without the self-cleaning recharger

Dry in a shade and apply oil.



Notes

- Be careful not to hit the main body on the sink or any other object while draining the water. Failure to do so may cause malfunction.
- Do not wipe with thinners, benzine, alcohol etc. Doing so may cause malfunction, or cracking or discoloration of the parts. Wipe with diluted soapy water.
- Do not use any kitchen or bathroom detergents other than hand soap. Doing so may cause malfunction.

- Do not use the self-cleaning recharger while droplets or soap remain on the shaver. Doing so may change the concentration level or composition of the cleaning liquid in the cleaning liquid unit, which may degrade cleaning, sterilization, lubrication and drying performance. This may also cause cleaning liquid to spill from the self-cleaning recharger.

Cleaning with the brush

Remove the outer foil section and the inner blades. (See this page.)

Clean the system outer foil in the areas indicated by the circles every time you use the shaver.

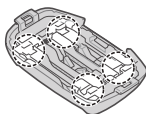

► Cleaning with the long brush

Clean the foil frame, system outer foil, the main body and the trimmer using the long brush.

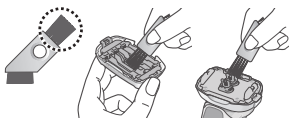

► Cleaning with the short brush

- Clean the inner blades using the short brush by moving it in direction as illustrated.
- Do not move the short brush perpendicularly against the blades as it will damage the inner blades and affect their sharpness.

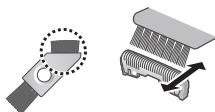

Replacing the system outer foil and the inner blades

system outer foil	once every year
inner blades	once every two years

► Removing the outer foil section

Press the foil frame release buttons and lift the outer foil section upwards.

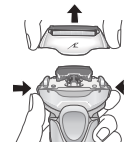

► Attaching the outer foil section

After turning the foil frame mark (↙) to the front, securely attach the outer foil section to the shaver until it clicks.

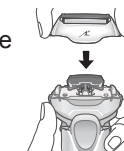

► Replacing the system outer foil

1. Press the system outer foil release buttons and pull down the system outer foil.

- Do not press the system outer foil release buttons with excessive force. Doing so may bend the system outer foil, preventing complete attachment to the foil frame.

2. Align the foil frame mark (↙) and the system outer foil mark (△) and securely attach together until it clicks.

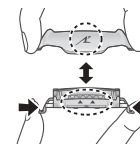

► Replacing the inner blades

1. Remove the inner blades one at a time.
2. Insert the inner blades one at a time.

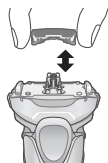

Note

Do not throw away the foil frame.

Replacing the cleaning liquid

If the STATUS lamp glows for 5 seconds when the SELECT button is pressed, the cleaning liquid needs to be replaced.

- Even if the STATUS lamp does not light up, replace the cleaning liquid after 6 months have passed.

1 Remove the AC adaptor and remove the cleaning liquid unit. (See page 11.)



2 Wash away the old cleaning liquid. • It can be drained as sewage.

3 Rinse the cleaning liquid unit.

- Pour water as illustrated while tilting the cleaning liquid unit and shaking it gently.



- You can clean with the cleaning liquid filter removed. After washing, be sure to attach the cleaning liquid filter.

4 Gently wipe off any beard trimmings attached to the inside of the cleaning tray (a) with a cloth or tissue paper dampened with water.

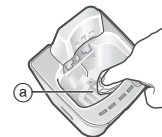

- Clean the corners and uneven parts of the cleaning tray with a cotton swab dampened with water.

5 Prepare the new cleaning liquid. (See page 11.)

Notes

- The cleaning liquid will decrease every time it is used, but do not add detergent and water except when replacing the cleaning liquid. Doing so may deteriorate the cleaning function.
- Do not wash the self-cleaning recharger unit with water.
- Do not wipe with thinners, benzine, alcohol etc. Doing so may cause malfunction, or cracking or discoloration of the parts. Wipe with diluted soapy water.
- Some cleaning liquid components and skin oil may separate and adhere to the cleaning liquid unit and cleaning liquid filter. This does not indicate a problem.

► **When the water does not drain from the cleaning tray**

- Do not tilt the self-cleaning recharger to pour out water. Doing so may cause the cleaning liquid in the cleaning liquid unit to spill or cause the self-cleaning recharger to malfunction.

- Beard trimmings may clog the drain at the bottom of the cleaning tray. In this case, you cannot clean or dry the shaver.

1. Be sure to remove the AC adaptor from the self-cleaning recharger.
2. Place the self-cleaning recharger on a flat surface, and push the beard trimmings down through the drain (b) with a toothpick etc.

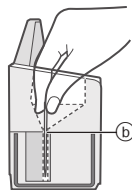

► **Replacement parts**

Replacement parts are available at your dealer or Service Center.

Replacement parts for ES-LV97	System outer foil and inner blades	WES9032
	System outer foil	WES9173
	Inner blades	WES9170
Special Detergent for Shaver Cleaning & Charging System		WES4L03

When the LOW/STATUS lamp glows

It indicates that the cleaning liquid is due for replacement when the LOW lamp or STATUS lamp glows for approximately 5 seconds when the SELECT button is pressed.

Lamp on the self-cleaning recharger	Content of notification
The LOW lamp glows. ►	Replacement of the cleaning liquid is required in approximately 7 days. Prepare the detergent.
The STATUS lamp glows. ►	Replace the cleaning liquid. (Modes other than the "AUTO" mode can be used even if it is not replaced.)
	If you think the replacement should not be due yet. <ul style="list-style-type: none"> • Is the cleaning liquid unit correctly attached? • Is the self-cleaning recharger placed in a level surface? • Is the self-cleaning recharger used outside the range of the recommended usage temperature? (Only "Charge" mode can be used.)

FAQ

Question	Answer
Why does "Dry/Charge" mode take longer than "AUTO" mode?	▶ This is due to the difference in the drying time. The drying time for the "Dry/Charge" mode is set longer as there may still be excess moisture on the areas other than the system outer foil after the shaver has been rinsed and cleaned with water.
Can I refill the self-cleaning recharger with water when the cleaning liquid has decreased?	▶ Do not refill with water as doing so may deteriorate the cleaning function. Replace the cleaning liquid.
Can the self-cleaning recharger be used to wash other models?	▶ Doing so may cause malfunction, so do not use with other models.
Will the battery deteriorate if not used for an extended period of time?	▶ The battery will deteriorate if not used for over 6 months, so make sure to perform a full charge at least once every 6 months.
Can I charge the shaver after every use?	▶ The battery used is a lithium-ion, so charging after every use will have no effect on battery life.

Question	Answer
Why should the adaptor be disconnected after charge?	▶ Charging the battery for more than 1 hour will not affect battery performance, but disconnect the adaptor for safety and to save energy.
What is the constituent of the dedicated oil and the detergent?	▶ Oil: Liquid paraffin Detergent: Non-ionic surfactant agent, antimicrobial agent, lubricant and fragrance.

Troubleshooting

Perform the following actions.
If the problems still cannot be solved or all self-cleaning recharger's lamps blink, contact the store where you purchased the unit or a service center authorized by Panasonic for repair.

► **Self-cleaning recharger**

Problem	Action
The blade has not been thoroughly washed.	<p>If the shaver is not cleaned for more than 2 weeks, first clean with the cleaning brush to remove beard trimmings. (See page 17.)</p> <p>Do not add detergent and water except when replacing the cleaning liquid. Doing so may deteriorate the cleaning function. (See page 18.)</p> <p>After cleaning, oil-like droplets may remain on the outside of the foil frame.</p> <p>This is the lubricating component of the cleaning liquid and does not indicate a problem. You may wipe it off with a soft cloth.</p>
The blades are not dry or are sticky.	<p>The blades may not dry quickly due to temperature conditions.</p> <p>Run the “Dry/Charge” mode again or wipe with a soft cloth before shaving.</p>

Problem	Action
The blades crack or deform during cleaning.	<p>Do not insert any foreign objects into the recharger.</p> <p>Replace the system outer foil and/or inner blades. (See page 17.)</p>
The cleaning liquid has foamed.	<p>If you mix soapy water or hand soap with the detergent or use another detergent, the cleaning liquid will foam. Use the self-cleaning recharger after thoroughly washing and drying the shaver.</p> <p>Replace the cleaning liquid. (See page 18.)</p>
Cleaning liquid has accumulated in the cleaning tray.	<p>Remove any waste, etc. that has accumulated in the drain at the bottom of the cleaning tray. (See page 19.)</p> <p>If you use the self-cleaning recharger when the shaver is wet or when soap or shaving gel is on the shaver, cleaning liquid may accumulate in the cleaning tray.</p>

Problem	Action
Cleaning liquid leaked from the cleaning liquid unit.	<ul style="list-style-type: none"> ▶ Do not press the cleaning liquid unit removal button during any mode. ▶ Place the self-cleaning recharger horizontally. If you use the self-cleaning recharger when the shaver is wet or when soap or shaving gel is on the shaver, cleaning liquid may leak.
The cleaning liquid unit cannot be removed.	<ul style="list-style-type: none"> ▶ Place the self-cleaning recharger on a hard, flat surface. (See page 11.)

Problem	Action
The mode does not start.	<ul style="list-style-type: none"> ▶ Check that the AC adaptor is connected to the self-cleaning recharger, and that the adaptor is plugged in to a household outlet. (See page 14.) ▶ Confirm that the shaver is properly attached to the self-cleaning recharger. (See page 14.) ▶ The Clean or Dry function may not operate under extreme low temperatures (approximately 0 °C or lower). ▶ Check if the STATUS lamp is glowing. (See page 19.)
The shaver cannot be charged.	<ul style="list-style-type: none"> ▶ Gently wipe the main body rear terminals and the charging terminals of the self-cleaning recharger with a cloth or tissue dampened with water.

Problem	Action
Makes a loud sound. ▶	<p>During cleaning: The self-cleaning recharger makes a loud sound due to the cleaning of the blades.</p> <p>After cleaning: The self-cleaning recharger makes a loud sound due to the removal of water droplets in order to speed drying.</p> <p>The sound after cleaning is different from the sound during cleaning. The water level has dropped and it is removing water droplets from the blades after cleaning. This does not indicate a problem.</p>

▶ **Shaver**

Problem	Action
The power switch does not turn ON. ▶	Unlock the switch lock. (See page 13.)

Problem	Action
The shaving sensor does not respond.	<p>Depending on the beard thickness or the amount of beard trimmings in the shaver head, the shaving sensor may not react and the driving sound may not change. This is not abnormal.</p> <p>▶ The shaving sensor may not respond depending on the type and quantity of the shaving gel. This is not abnormal.</p> <p>▶ The shaving sensor may not respond when the remaining battery capacity is low. If this happens, recharge the shaver.</p> <p>Apply oil. (See page 16.)</p> <p>▶ The shaving sensor may not respond when there is not enough oil on the blades.</p>

Problem	Action
The shaving sensor responds even though the shaver is not in contact with the skin.	<p>Clean the beard trimmings from the shaver. When the shaver is extremely dirty, remove the foil frame and wash with water. (See page 15.)</p> <p>▶ Replace the system outer foil and/or inner blades. Expected life of system outer foil and inner blades: System outer foil: Approximately 1 year Inner blades: Approximately 2 years</p>

Problem	Action
Operating time is short even after a full charge.	<p>▶ Although the shaver can be used for about 2 weeks after a full charge (assuming dry-shave usages for 3 minutes per day), the usable number of days might be lower depending on how the shaver is used (for example, when used for wet shaving).</p> <p>▶ Apply oil. This can be improved by cleaning every time after shaving.</p> <p>▶ When the number of operations per charge starts to decrease, the battery is nearing the end of its life.</p>
Shaver does not operate even after charging.	<p>▶ Use the appliance in an ambient temperature approximately 5 °C or higher.</p> <p>▶ The battery has reached the end of its life.</p> <p>▶ The shaver will not operate with the AC adaptor connected. Please use the shaver after it has been sufficiently charged and the AC adaptor disconnected.</p>

Problem	Action
The driving sound changes while shaving.	▶ The shaving sensor is operating. The sound changes depending on the beard thickness.
Makes a loud sound.	▶ Apply oil. The blades will not move smoothly when there is no oil on the blades, requiring more power.
	▶ The shaver makes a high-pitched sound due to the linear motor drive. This does not indicate a problem.
	▶ Confirm that the blades are properly attached.
The odor is getting stronger.	▶ Clean the system outer foil with the brush. (See page 17.)
	▶ This can be improved by cleaning every time after shaving.
Shavings fly out in all directions.	▶ This can be improved by cleaning every time after shaving.
	▶ Clean the inner blades with the brush when shavings are adhering to the inner blades.

Problem	Action
System outer foil gets hot.	▶ Apply oil.
	▶ Replace the system outer foil if it is damaged or deformed. (See page 17.)
You do not get as close a shave as before.	▶ This can be improved by cleaning every time after shaving.
	▶ Replace the system outer foil and/or inner blades. Expected life of system outer foil and inner blades: System outer foil: Approximately 1 year Inner blades: Approximately 2 years
	▶ Apply oil.

Battery life

The life of the battery is 3 years. The battery in this shaver is not intended to be replaced by consumers. Have the battery replaced by an authorized service center.

Removing the built-in rechargeable battery

Remove the built-in rechargeable battery before disposing of the shaver.

The battery is to be disposed of safely.

Please make sure that the battery is disposed of at an officially designated location if there is one.

This figure must only be used when disposing of the shaver, and must not be used to repair it. If you dismantle the shaver yourself, it will no longer be waterproof, which may cause it to malfunction.

- Remove the shaver from the AC adaptor.
- Press the power switch to turn on the power and then keep the power on until the battery is completely discharged.

- Perform steps ① to ⑤ and lift the battery, and then remove it.
- Take care not to short circuit the positive and negative terminals of the removed battery, and insulate the terminals by applying tape to them.

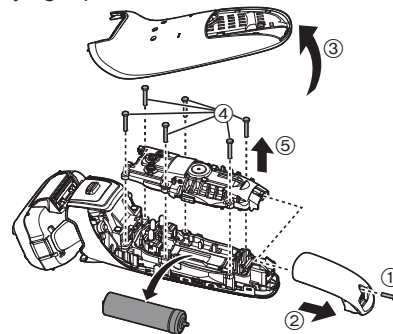

For environmental protection and recycling of materials
This shaver contains a Lithium-ion battery.
Please make sure that the battery is disposed of at an officially assigned location, if there is one in your country.

Specifications

Power source	See the name plate on the AC adaptor. (Automatic voltage conversion)
Motor voltage	3.6 V \equiv
Charging time	Approx. 1 hour

This product is intended for household use only.



Panasonic Corporation
<http://www.panasonic.com>
© Panasonic Corporation 2019

Ⓕ EN

Printed in Japan
ES9700LV971H Y0619-0

