

Operating Instructions LED TV

English

Model No.

TH-55HX900Z

TH-65HX900Z



(image: TH-65HX900Z)



**For more detailed instructions, please refer to [eHELP]
(Built-in Operating Instructions).**

- How to use [eHELP] ➔ (p. 18)

Thank you for purchasing this Panasonic product.

Please read these instructions carefully before operating this product and retain them for future reference.

Please carefully read the “Safety Precautions” of this manual before use.

The images shown in this manual are for illustrative purposes only.



FBC

Contents

Be Sure to Read

Important Notice	3
Safety Precautions	4
Accessories	7
Installing the TV	7
Installing the wall-hanging bracket	10
Connections	10
Identifying Controls	15
First time Auto Tuning	17
How to Use eHELP	18
FAQs	19
Maintenance	20
Specifications	21



The terms HDMI and HDMI High-Definition Multimedia Interface, and the HDMI Logo are trademarks or registered trademarks of HDMI Licensing Administrator, Inc. in the United States and other countries.

Dolby, Dolby Vision, Dolby Atmos, Dolby Audio, and the double-D symbol are trademarks of Dolby Laboratories. Manufactured under license from Dolby Laboratories. Confidential unpublished works.

Copyright © 2012-2019 Dolby Laboratories. All rights reserved.

The Bluetooth® word mark and logos are registered trademarks owned by Bluetooth SIG, Inc. and any use of such marks by Panasonic Corporation is under license.

x.v.Colour™ is a trademark.

DiSeqC™ is a trademark of EUTELSAT.

- For information about the trademarks, refer to [eHELP] (Search by Purpose > Read first > Before use > Licence).

The illustration for TH-65HX900Z is used in this manual unless otherwise mentioned.

Illustrations shown may be different between models and countries.

Important Notice

Internet apps are provided by their respective service providers, and may be changed, interrupted, or discontinued at any time.

Panasonic assumes no responsibility and makes no warranty for the availability or the continuity of the services.

Panasonic does not guarantee operation and performance of peripheral devices made by other manufacturers; and we disclaim any liability or damage arising from operation and/or performance from usage of such other maker's peripheral devices.

Handling of customer information

Certain customer information such as IP address of your device (this TV)'s network interface will be collected as soon as you connect your Panasonic-branded smart television (this TV) or other devices to the internet (excerpted from our privacy policy). We do this to protect our customers and the integrity of our Service as well as to protect the rights or property of Panasonic. If you wish to know more about the processing of your information in this context, please refer to the full text of our privacy policy displayed at [eHELP] (Search by Purpose > Network > Network settings > Terms of Service and Settings).

When using Internet connecting function of this TV, after agreeing (in the jurisdictions where customer's consent is required to collect personal information under applicable privacy laws) to or reviewing Panasonic's terms of service / privacy policy (hereinafter referred to as terms and conditions etc.), customer information on the use of this unit may be collected and used according to terms and conditions etc.

For details of terms of service / privacy policy, refer to [eHELP] (Search by Purpose > Network > Network settings > Terms of Service and Settings).

Customer's personal information may be recorded on this TV by broadcasting organization or application provider. Before repairing, transferring or discarding this TV, erase all the information recorded on this TV according to the following procedure.

[eHELP] (Search by Purpose > Functions > Shipping Condition).

Customer Information may be collected by provider via application provided by third parties on this TV or website. Please confirm the terms and conditions etc. of provider in advance.

- Panasonic will not be held responsible for collecting or using customer information via application provided by third party on this TV or website.
- When entering your credit card number, name, etc., pay special attention to the trustworthiness of the provider.

- Registered information may be registered in the server etc. of provider. Before repairing, transferring or discarding this TV, be sure to erase the information according to the terms and conditions etc. of provider.

The recording and playback of content on this or any other device may require permission from the owner of the copyright or other such rights in that content. Panasonic has no authority to and does not grant you that permission and explicitly disclaims any right, ability or intention to obtain such permission on your behalf. It is your responsibility to ensure that your use of this or any other device complies with applicable copyright legislation in your country. Please refer to that legislation for more information on the relevant laws and regulations involved or contact the owner of the rights in the content you wish to record or playback.

This product is licensed under the AVC patent portfolio license for the personal use of a consumer or other uses in which it does not receive remuneration to (i) encode video in compliance with the AVC Standard ("AVC Video") and/or (ii) decode AVC Video that was encoded by a consumer engaged in a personal activity and/or was obtained from a video provider licensed to provide AVC Video. No license is granted or shall be implied for any other use.

Additional information may be obtained from MPEG LA, L.L.C.

See <http://www.mpegla.com>

Panasonic and its affiliates make no representations or warranties of any kind with respect to the USB devices and the performance of communication between the USB devices and the USB port of Panasonic products, and expressly disclaims any and all warranties, whether express or implied or otherwise, including without limitation any implied warranty of fitness for a particular purpose, any loss of data, and any implied warranties arising from course of dealing or course of performance of data communication between the USB devices and the USB port of Panasonic products.

Transport only in upright position.



This mark indicates the product operates on AC voltage.



This mark indicates a Class II or double insulated electrical appliance wherein the product does not require a safety connection to electrical earth (ground).

Safety Precautions

To help avoid risk of electrical shock, fire, damage or injury, please follow the warnings and cautions below:

■ Mains plug and lead

Warning

If you detect anything unusual, immediately remove the mains plug.

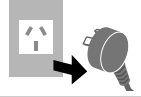

- This TV is designed to operate on AC ~ 220-240 V, 50 / 60 Hz.
- Insert the mains plug fully into the mains socket.
- To turn Off the apparatus completely, you must pull the mains plug out of the mains socket. Consequently, the mains plug should be easily accessible at all times.
- Disconnect the mains plug when cleaning the TV.
- Do not touch the mains plug with wet hands.



- Do not damage the mains lead.

- Do not place a heavy object on the lead.



- Do not place the lead near a high temperature object.



- Do not pull on the lead. Hold onto the mains plug body when disconnecting the plug.



- Do not move the TV with the lead plugged into a mains socket.
- Do not twist the lead, bend it excessively or stretch it.
- Do not use a damaged mains plug or mains socket.
- Ensure the TV does not crush the mains lead.
- Do not use any mains lead other than that provided with this TV.

■ Take care

Warning

- Do not remove covers and never modify the TV yourself as live parts are accessible and risk of electric shock when they are removed. There are no user serviceable parts inside.



- Do not expose the TV to rain or excessive moisture. This TV must not be exposed to dripping or splashing water and objects filled with liquid, such as vases, must not be placed on top of or above the TV.



- Do not insert foreign objects into the TV through the air vents.
- If the TV is used in an area where insects may easily enter the TV.

It is possible for insects to enter the TV, such as small flies, spiders, ants, etc. which may cause damage to the TV or become trapped in an area visible on the TV, e.g. within the screen.

- Do not use an unapproved pedestal / mounting equipment. Be sure to ask your local Panasonic dealer to perform the setup or installation of approved wall-hanging brackets.
- Do not apply any strong force or impact to the display panel.
- Ensure that children do not climb on the TV.
- Do not place the TV on sloping or unstable surfaces, and ensure that the TV does not hang over the edge of the base.



Warning

Never place a TV in an unstable location. A TV may fall, causing serious personal injury or death. Many injuries, particularly to children, can be avoided by taking simple precautions such as:

- Using cabinets or stands recommended by the manufacturer of the TV.
- Only using furniture that can safely support the TV.
- Ensuring the TV is not overhanging the edge of the supporting furniture.
- Not placing the TV on tall furniture (for example, cupboards or bookcases) without anchoring both the furniture and the TV to a suitable support.
- Not placing the TV on cloth or other materials that may be located between the TV and supporting furniture.
- Educating children about the dangers of climbing on furniture to reach the TV or its controls.

If your existing TV is being retained and relocated, the same considerations as above should be applied.

- This TV is designed for indoor use.
- This TV is designed for table-top use.
- Do not expose the TV to direct sunlight and other sources of heat.



To prevent the spread of fire, keep candles or other open flames away from this product at all times



■ Suffocation / Choking Hazard

Warning

- The packaging of this product may cause suffocation, and some of the parts are small and may present a choking hazard to young children. Keep these parts out of reach of young children.

■ Pedestal

Warning

- Do not disassemble or modify the pedestal.

Caution

- Do not use any pedestal other than the one provided with this TV.
- Do not use the pedestal if it becomes warped or physically damaged. If this occurs, contact your nearest Panasonic dealer immediately.
- During setup, make sure that all screws are securely tightened.
- Ensure that the TV does not suffer any impact during installation of the pedestal.
- Ensure that children do not climb onto the pedestal.
- Install or remove the TV from the pedestal with at least two people.
- Install or remove the TV according to the specified procedure.

■ Radio waves

Warning

- Do not use the TV in any medical institutions or locations with medical equipment. Radio waves may interfere with the medical equipment and may cause accidents due to malfunction.
- Do not use the TV near any automatic control equipment such as automatic doors or fire alarms. Radio waves may interfere with the automatic control equipment and may cause accidents due to malfunction.
- Keep at least 15 cm away from the TV if you have a cardiac pacemaker. Radio waves may interfere with the operation of the pacemaker.
- Do not disassemble or alter the TV in any way.

■ Built-in wireless LAN

Caution

- Do not use the built-in wireless LAN to connect to any wireless network (SSID*) for which you do not have usage rights. Such networks may be listed as a result of searches. However, using them may be regarded as illegal access.

*SSID is a name for identifying a particular wireless network for transmission.

- Do not subject the built-in wireless LAN to high temperatures, direct sunlight or moisture.
- Data transmitted and received over radio waves may be intercepted and monitored.
- The built-in wireless LAN uses 2.4 GHz and 5 GHz frequency bands. To avoid malfunctions or slow response caused by radio wave interference when using the built-in wireless LAN, keep the TV away from other devices that use 2.4 GHz and 5 GHz signals such as other wireless LAN devices, microwave ovens, and mobile phones.
- When problems occur due to static electricity, etc., the TV might stop operating to protect itself. In this case, turn the TV off at the Mains power On / Off switch, then turn it back on.

■ Bluetooth® wireless technology

Caution

- The TV uses the 2.4 GHz radio frequency ISM band (Bluetooth®). To avoid malfunctions or slow response caused by radio wave interference, keep the TV away from the devices such as other wireless LAN devices, other Bluetooth devices, microwaves, mobile phones and the devices that use 2.4 GHz signal.

■ Ventilation

Caution

Allow sufficient space (at least 10 cm) around the TV in order to help prevent excessive heat, which could lead to early failure of some electronic components.

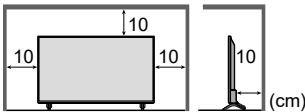

- Ventilation should not be impeded by covering the ventilation openings with items such as newspapers, tablecloths and curtains.
- Whether you are using a pedestal or not, always ensure the vents at the bottom of the TV are not blocked and there is sufficient space to enable adequate ventilation.



■ Moving the TV

Caution

Before moving the TV, disconnect all cables.

- At least two people are required to move the TV. Support the TV as shown below to prevent injury that may be caused by the tipping or falling of TV.

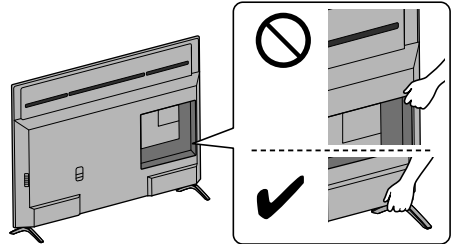

■ When not in use for a long time

Caution

This TV will still consume some power even in the Off mode, as long as the mains plug is still connected to a live mains socket.

- Remove the mains plug from the wall socket when the TV is not in use for a prolonged period of time.

■ Excessive volume

Caution

- Do not expose your ears to excessive volume from the headphones. Irreversible damage can be caused.
- If you hear a drumming noise in your ears, turn down the volume or temporarily stop using the headphones.



■ Battery for the Remote Control





Caution

- Incorrect installation may cause battery leakage, corrosion and explosion.
- Replace only with the same or equivalent type.
- Do not mix old and new batteries.
- Do not mix different battery types (such as alkaline and manganese batteries).
- Do not use rechargeable batteries (Ni-Cd, etc.).
- Do not burn or break up batteries.
- Do not expose batteries to excessive heat such as sunshine, fire or the like.
- Make sure you dispose of batteries correctly.
- Remove the battery from the unit when not using for a prolonged period of time to prevent battery leakage, corrosion and explosion.

Accessories

Standard accessories

Make sure the following accessories are included with your TV. If any items are missing, contact your dealer.

1. Mains lead ⇒ (p. 11)	2. Remote Control ⇒ (p. 15) <ul style="list-style-type: none">• N2QAYB001252 
3. Pedestal ⇒ (p. 7)	4. Batteries (2) ⇒ (p. 16) <ul style="list-style-type: none">• R6 
5. AV adaptor ⇒ (p. 12) 	6. Cable band (2) ⇒ (p. 14) Assembly screw (2) M4 x 5.5 (mm) 
7. Fall prevention parts ⇒ (p. 9) <ul style="list-style-type: none">• The fall-prevention band is fixed to the pedestal with tapes.	

Check for any accessories hidden behind or in the packing material when opening the box.

Operating Instructions with Warranty statement

- Accessories may not be placed all together. Take care not to throw them away unintentionally.
- Illustrations shown above may be different between models and countries.

Installing the TV

Assembling / Removing the pedestal

Preparations

Take out the pedestal and the TV from the packing case and put the TV onto a work table with the screen panel down on the clean and soft cloth (blanket, etc.)

- Use a flat and firm table bigger than the TV.
- Do not hold the screen panel part.
- Make sure not to scratch or break the TV.

Assembling the pedestal

- Select a method to assemble the pedestal from the following 2 styles.
- Insert the pedestal firmly, otherwise it may come off when setting up the TV.
- Do not assemble the pedestal by any method other than those specified below.

Style1

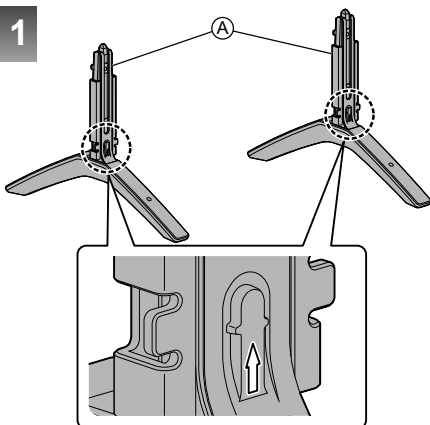
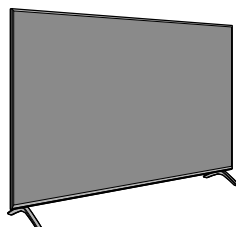

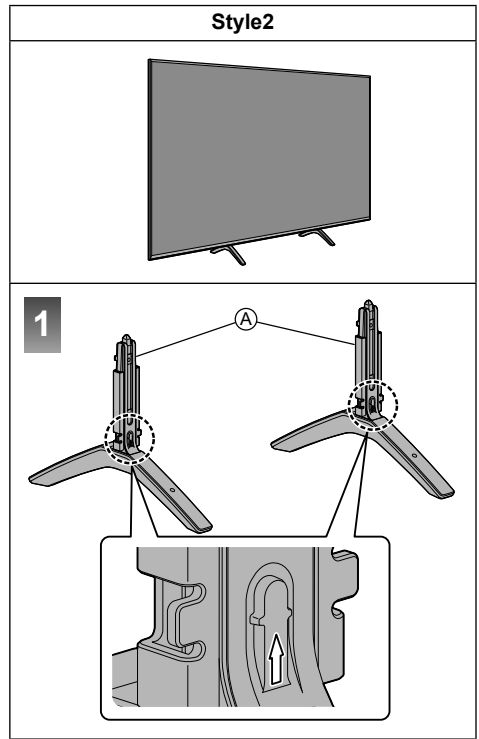
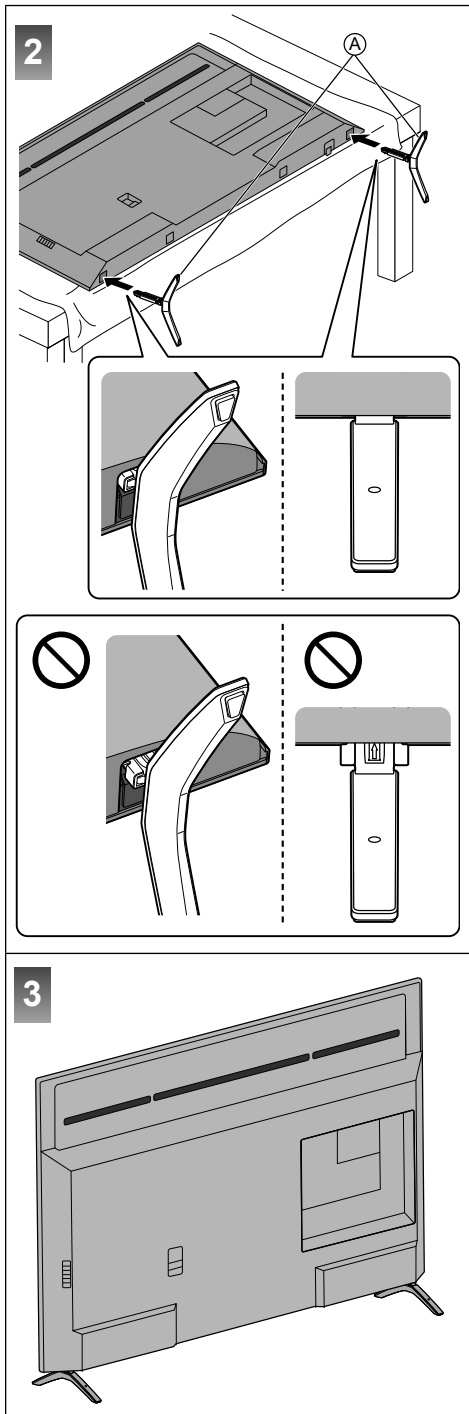

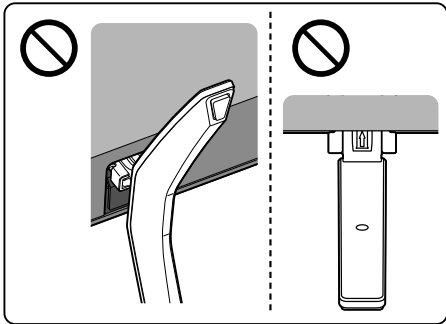
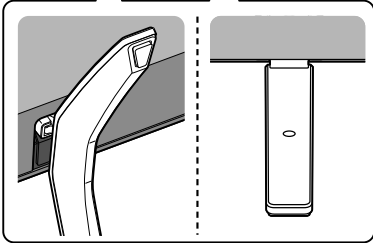
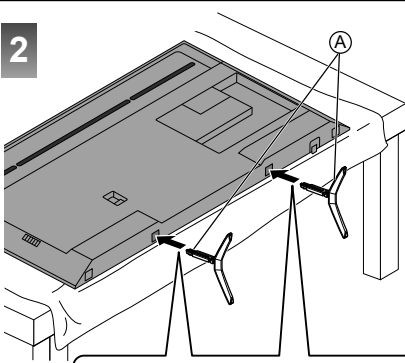
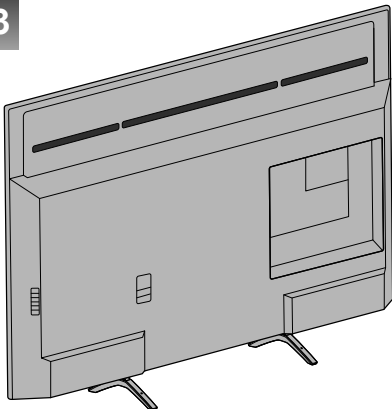
2**3**

Removing the pedestal from the TV

Be sure to remove the pedestal in the following procedures when you use the wall-hanging bracket or repack the TV.

- 1 Put the TV onto a work table with the screen panel down on the clean and soft cloth.
- 2 Pull out the pedestal from the TV.

Preventing the TV from falling over

Be sure to secure the pedestal to a furniture as shown to prevent the TV from falling over.

- This information is designed to reduce the risk of injuries caused by the TV falling over. However, no measure can guarantee prevention from falling over in all cases including the disasters.

Attaching the fall-prevention parts

- A Band (1)**

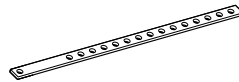

- B Wood screw (1)**



- 1 Remove the screw.

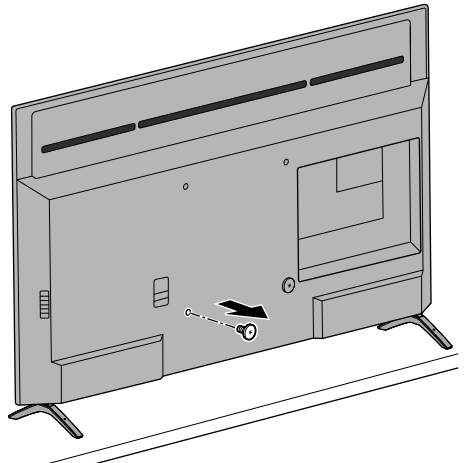

- 2 Attach the fall-prevention parts.

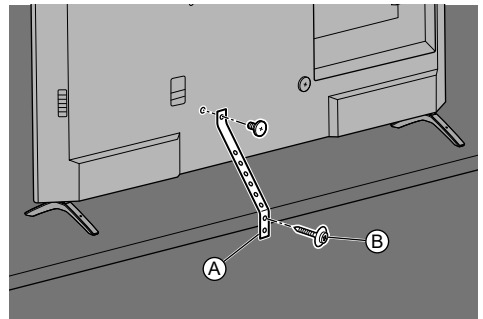

Installing the wall-hanging bracket

Choosing to wall mount the TV shall be done at the owner's risk. Always use a qualified installer to perform a TV wall bracket installation. Incorrect fitting may cause equipment to fall, resulting in injury and product damage. Any such damage will void your warranty.

- Holes for wall-hanging bracket installation
Rear of the TV

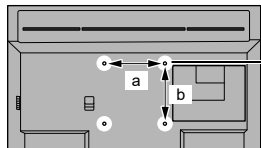

55-inch model
a: 300 mm
b: 300 mm

65-inch model
a: 400 mm
b: 300 mm

(View from the side)

Depth of screw
minimum: 9 mm
maximum: 30 mm

Type of screw: M6

Screw for fixing the TV onto the wall-hanging bracket (not supplied with the TV)

Warning

- Using other wall-hanging brackets, or installing a wall-hanging bracket by yourself have the risk of personal injury and product damage. In order to maintain the unit's performance and safety, be absolutely sure to ask your dealer or a licensed contractor to secure the wall-hanging brackets. Any damage caused by installing without a qualified installer will void your warranty.
- Carefully read the instructions accompanying optional accessories, and be absolutely sure to take steps to prevent the TV from falling off.
- Handle the TV carefully during installation since subjecting it to impact or other forces may cause product damage.
- Take care when fixing wall brackets to the wall. Always ensure that there are no electrical cables or pipes in the wall before hanging bracket.
- To prevent fall and injury, remove the TV from its fixed wall position when it is no longer in use.

Connections

- External equipment and cables shown are not supplied with this TV.
- Please ensure that the unit is disconnected from the mains socket before attaching or disconnecting any cables.
- Check the terminal type and cable plugs are correct for connection.
- Use a fully wired HDMI compliant cable.
- Keep the TV away from electronic equipment (video equipment, etc.) or equipment with an infrared sensor, otherwise distortion of image / sound may occur or operation of other equipment may be affected.
- Please also read the manual of the equipment being connected.

Terminals

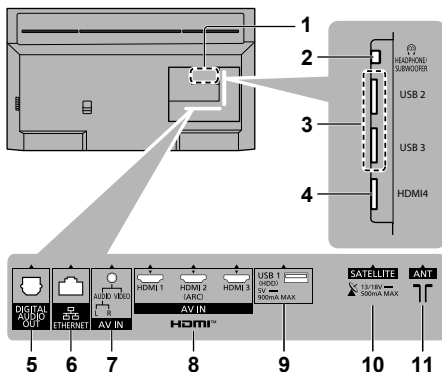

- Model name plate
- Headphone / Subwoofer jack → (p. 13)
- USB 2 - 3 port
== This symbol indicates DC operation.
- HDMI 4
- DIGITAL AUDIO OUT
- ETHERNET terminal → (p. 12)
- AV IN → (p. 12)
- HDMI 1 - 3 → (p. 11 - 13)
- USB 1 port → (p. 13)
== This symbol indicates DC operation.
- Satellite terminal → (p. 11)
- Aerial terminal → (p. 11)
 - To watch content in 4K format, use HDMI terminal.
→ (p. 12)

Basic connections

■ Mains lead

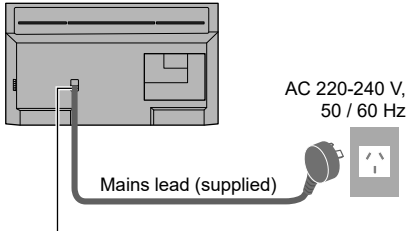

Insert the mains plug firmly into place.

- When disconnecting the mains lead, be absolutely sure to disconnect the mains plug from the mains socket first.



■ Aerial

TV

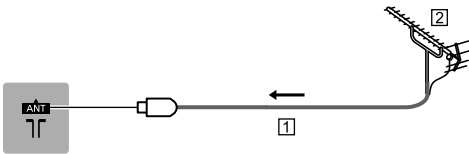

- 1 RF cable
- 2 Aerial

- For Digital TV, Analogue TV
- Keep RF (aerial) cable away from the mains lead to avoid and minimise mains interference pickup.
- Do not place the RF cable under the TV.
- An aerial, correct cable (75 Ω coaxial) and correct terminating plug are required to obtain optimum quality picture and sound.
- If a communal aerial system is used, you may require the correct connection cable and plug between the wall aerial socket and the TV.
- Your local Television Service Centre or dealer may be able to assist you in obtaining the correct aerial system for your particular area and the accessories required.
- Any matters regarding aerial installation, upgrading of existing systems or accessories required, and the costs incurred, are the responsibility of you, the customer.

■ Satellite dish

TV

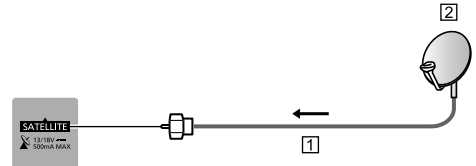

- 1 Satellite cable
- 2 Satellite dish

- For Satellite TV
- To ensure your satellite dish is correctly installed, please consult your local dealer. Also consult the received satellite broadcasting companies for details.

AV devices

■ DVD Recorder / Blu-ray Recorder, etc.

TV

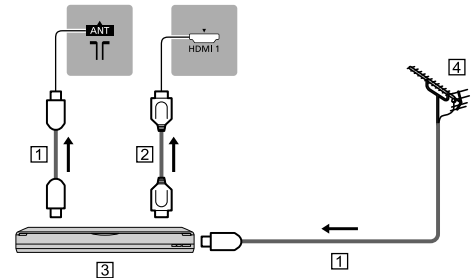

- 1 RF cable
- 2 HDMI cable
- 3 DVD Recorder / Blu-ray Recorder, etc.
- 4 Aerial

■ Set top box

TV

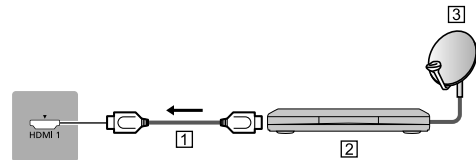

- 1 HDMI cable
- 2 Set top box
- 3 Satellite dish

Network

A broadband network environment is required to be able to use internet services.

- If you do not have any broadband network services, please consult your retailer for assistance.
- Prepare the internet environment for wired connection or wireless connection.
- Setup of the network connection will start when first using the TV. ➔ (p. 17)

■ Wired connection

TV

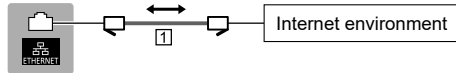

1 LAN cable (Shielded)

- Use Shielded Twist Pair (STP) LAN cable.

■ Wireless connection



1 Built-in wireless LAN

2 Access point

Connections for 4K / HDR compatible equipment

TV

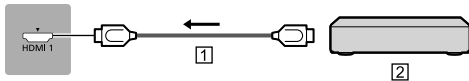

1 HDMI cable

2 4K / HDR compatible equipment

- Connect the 4K compatible equipment to HDMI terminal using a 4K compatible cable and you can watch content in 4K format.
- Supporting HDR does not increase the peak brightness capabilities of the TV panel.

■ [HDMI Auto Setting] [Setup Menu]

Reproduces the image more precisely with the expanded colour gamut when connecting the 4K compatible equipment. Select the mode depending on the equipment.

[Mode1]:

For better compatibility. Set to [Mode1] when the image or sound in HDMI input is not played properly.

[Mode2]:

For the 4K compatible equipment that has the function to output the image precisely with the expanded colour gamut.

- To change the mode

1. Select the HDMI input mode connected to the equipment.
 2. Display the menu and select [HDMI Auto Setting] (Setup Menu).
- For information about the valid format, refer to [eHELP] (Search by Purpose > Watching > 4K resolution > HDMI Auto Setting).

Other connections**

■ DVD Player / Camcorder / Game equipment

TV

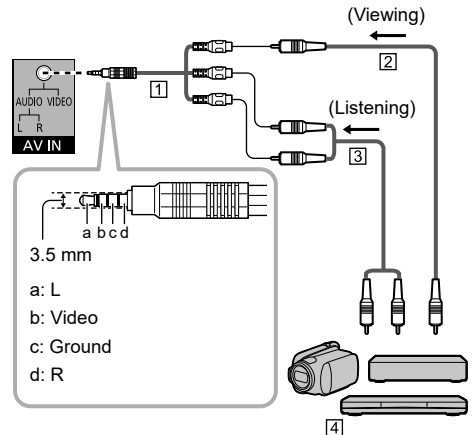

1 AV adaptor (Shielded)

2 Composite video cable (Shielded)

- Use shielded composite cable.

3 Audio cable (Shielded)

- Use shielded audio cables.

4 DVD Player / Camcorder / Game equipment

■ Amplifier (external speakers)

TV

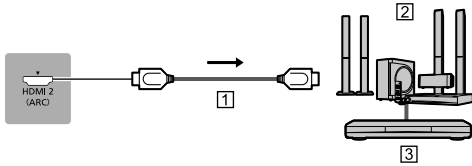

1 HDMI cable

2 Amplifier with speaker system

3 External equipment (DVD Player, etc.)

- Use HDMI2 to connect the TV to an amplifier which has ARC (Audio Return Channel) function.

If connecting to an amplifier without ARC function, use DIGITAL AUDIO OUT.

TV

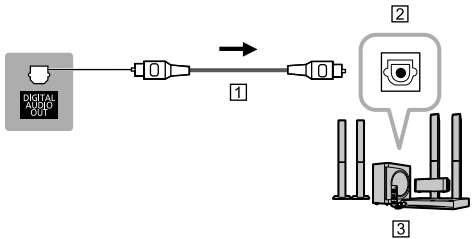

1 Optical cable

2 DIGITAL AUDIO IN

3 e.g. Amplifier with speaker system

■ Headphones

- To use the headphones, set [Headphone Terminal Output] to [Headphone].

TV

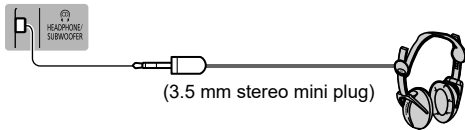

(3.5 mm stereo mini plug)

■ Subwoofer

- To use the subwoofer, set [Headphone Terminal Output] to [Sub Woofer]. (The subwoofer output from the TV is the same for both L and R).

TV

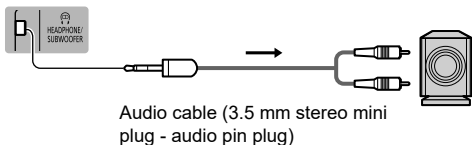

Audio cable (3.5 mm stereo mini plug - audio pin plug)

■ USB HDD (for recording)

- Use USB 1 port for connecting the USB HDD.
- For details, refer to [eHELP] (Search by Purpose > Recording).

■ VIERA Link

- Use HDMI1 - 4 for VIERA Link connection.
- For details, refer to [eHELP] (Search by Purpose > Functions > VIERA Link "HDAVI Control™").

** For more details on Other Connection, refer to [eHELP] (Search by Purpose > Watching > External Connection)

Cable arrangement

■ Fixing the cables using the cable band

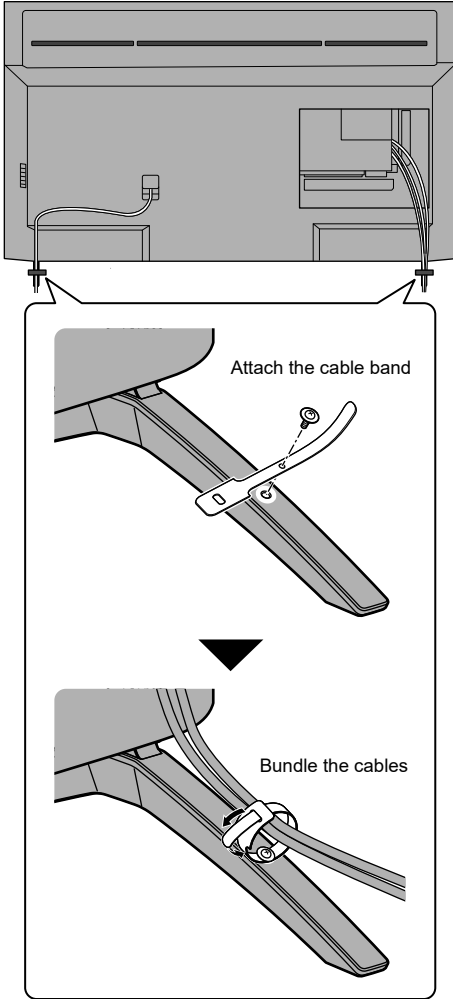

Note

- Fix cables as necessary.
- When using the optional accessory, follow the option's assembly manual to fix cables.

Identifying Controls

Remote Control

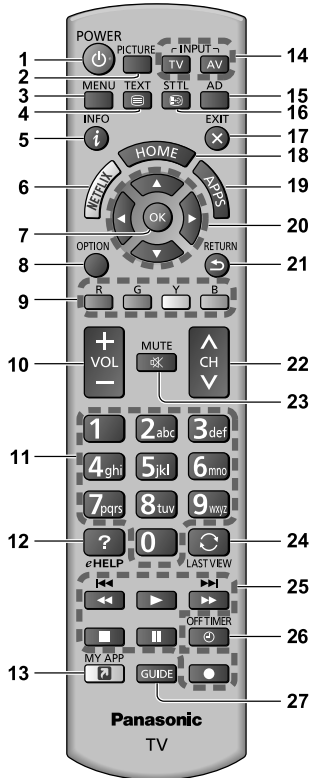

- 1 **[Power]**
 - Switches TV On or Off (Standby)
- 2 **PICTURE**
 - Changes viewing mode.
- 3 **[Main Menu]**
 - Access Picture, Sound, Network, Timer, Setup and Help Menus, etc.
- 4 **Teletext button**
 - Switches to teletext mode.
- 5 **Information**
 - Display channel and programme information.
- 6 **NETFLIX**
 - Accesses NETFLIX service directly.
 - A broadband network environment is required in order to fully use this function.
 - This service may be stopped or changed without notice.

- 7 **OK**
 - Confirms selections and choices.
- 8 **[Option Menu]**
 - Easy optional setting for viewing, sound, etc.
- 9 **Coloured buttons (red-green-yellow-blue)**
- 10 **Volume Up / Down**
- 11 **Numeric buttons**
 - Changes channel and teletext pages.
 - Sets characters.
 - When in Standby mode, switches TV on.
- 12 **[eHELP]**
 - Built-in Operating Instructions.
- 13 **[MY APP]****
- 14 **Input mode selection**
 - TV - switches to Satellite TV / Digital TV / Analogue TV.
 - AV - switches to AV input mode from Input Selection list.
- 15 **Audio Description**
- 16 **Subtitles**
- 17 **EXIT**
 - Returns to the normal viewing screen.
- 18 **HOME****
- 19 **APPS****
- 20 **Cursor buttons**
- 21 **RETURN**
 - Returns to the previous menu / page.
- 22 **Channel Up / Down**
- 23 **Sound Mute On / Off**
- 24 **Last view**
 - Switches to previously viewed channel or input mode.
- 25 **Operations for contents, connected equipment, etc.**
- 26 **Off Timer**
 - Sets the time for the TV to automatically turn off.
- 27 **TV Guide**
 - Displays Electronic Programme guide.

For more details on Remote Control, refer to **[eHELP] (**Search by Purpose > Home**)

■ Installing / Removing batteries

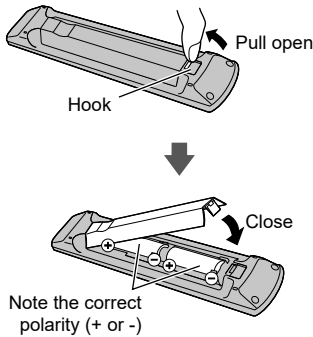

Indicator / Control panel

- When pressing 4, 5, 6 buttons, the control panel guide appears on the right side of the screen for 3 seconds to highlight which button has been pressed.

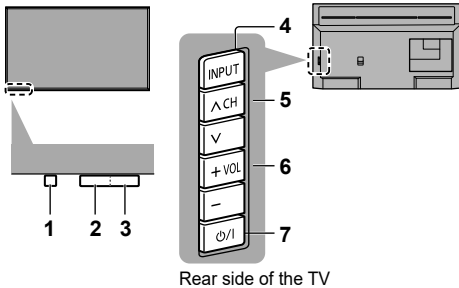

1 Power LED

Red: Standby

Green: On

Orange: Standby with some functions (recording, etc.) active

- The LED blinks when the TV receives a command from the remote control.

2 Ambient sensor

- Senses brightness to adjust picture quality when [Ambient Sensor] in the Picture Menu is set to [On].

3 Remote control signal receiver

- Do not place any objects between the TV remote control signal receiver and remote control.

4 Input mode selection

- Press repeatedly until you reach the desired mode.

[Main Menu]

- Press and hold for about 3 seconds to display main menu.

OK (when in the menu system)

5 Channel Up / Down

- Cursor Up / Down (when in the menu system).

6 Volume Up / Down

- Cursor Left / Right (when in the menu system).

7 Mains power On / Off switch

- Use to switch the mains power.
- To turn Off the apparatus completely, you must pull the mains plug out of the mains socket.
- [⏻/⏪]: Standby / On

First time Auto Tuning

When the TV is turned on for the first time, it will automatically search for available TV channels and give options to set up the TV.

- These steps are not necessary if the setup has been completed by your local dealer.
- Please complete connections (p. 10 - 13) and settings (if necessary) of the connected equipment before starting Auto Tuning. For information about the settings for the connected equipment, read the manual of the equipment.

1 Plug the TV into a live mains socket and turn the power on

POWER • Takes a few seconds to be displayed.

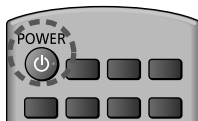

2 Select the following items

Set up each item by following the on-screen instructions.

Example:

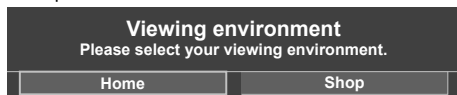

■ How to use the remote control



Move the cursor



Access the item / store the setting

RETURN



Return to the previous item (if available)

Select the language

Select [Home]

Select [Home] for use in a home viewing environment.

- [Shop] is for shop display.
- To change the viewing environment later on, the set will need to have all settings initialised by accessing Shipping Condition.

OTT service advertisement screen

Set up the network connection

Tick the TV signal mode to tune, and then select [Start Auto Tuning]

- : Satellite TV
- : Digital TV
- : Digital TV (DVB-T2)
- : Analogue TV

If satellite TV is selected, select your preferred Satellite TV search mode

Satellite TV Auto Setup (Select region)

Auto Tuning is now complete and the TV is ready for viewing.

If tuning has failed check the Satellite cable, RF cable, and the network connection, and then follow the on-screen instructions.

Note

- The TV goes into Standby mode when no operation is performed for 4 hours if [Auto Standby] in the Timer Menu is set to [On].
- The TV goes into Standby mode when no signal is received and no operation is performed for 10 minutes if [No signal Power off] in the Timer Menu is set to [On].
- To retune all channels
 - ➔ [Auto Tuning] in [Tuning Menu] (Setup Menu)
- If no satellite channel is found, set [LNB Band Frequency] to suit your environment.
 - ➔ [LNB Configuration] in [Satellite TV Tuning Menu] (Setup Menu)
- To add the available TV signal mode later
 - ➔ [Add TV Signal] in [Tuning Menu] (Setup Menu)
- To initialise all settings
 - ➔ [Shipping Condition] in [System Menu] (Setup Menu)

How to Use eHELP

[eHELP] is the detailed operating instructions built into the TV, and gives a more detailed explanation for a better understanding of the operation of each feature.

1 Display [eHELP]



or



[Help]



[eHELP]

- If the [eHELP] has been accessed previously since the TV was turned on, the confirmation screen is displayed to select whether to go to the [First page] or to the [Last viewed page].

2 Select the menu

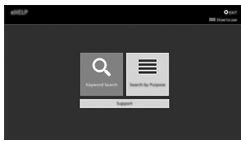

- To access [How to use]
G (green)

- [Keyword Search]:**
Search the content of eHELP in the keyword.
- [Search by Purpose]:**
Search the content of eHELP for each item.
- [Support]:**
Access the support information (FAQs, etc.).

3 Select the item

Example:

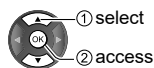
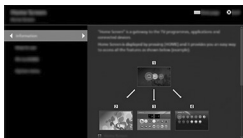

- To return to the previous screen / field
RETURN

- To scroll the description (if more than 1 page)
While the description is highlighted



- To open the reference screen ( →)



- To display the menu related to the description (only for some descriptions)
R (red)
- To check the features of this TV
Search by Purpose > Read first > Features

FAQs

Before requesting service or assistance, please follow these simple guides to solve the problem.

- For details, refer to [eHELP] (Support > FAQs).
-

The TV does not switch on

- Check the mains lead is plugged into the TV and the mains socket.
-

The TV goes into Standby mode

- Auto power standby function is activated.
-

The remote control does not work or is intermittent

- Are the batteries installed correctly? ➔ (p. 16)
 - Has the TV been switched on?
 - The batteries may be running low. Replace them with new ones.
 - Point the remote control directly at the TV's remote control signal receiver (within about 7 m and a 30 degree angle of the signal receiver).
 - Situate the TV away from sunshine or other sources of bright light so they do not shine on the TV's remote control signal receiver.
-

No image is displayed

- Check the TV is turned on.
 - Check the mains lead is plugged into the TV and the mains socket.
 - Check the correct input mode is selected.
 - Check the setting of [AV] in [Input Selection] to match the signal being output by the external equipment.
 - Is [Backlight], [Contrast], [Brightness] or [Colour] in the Picture Menu set to the minimum?
 - Check all required cables and connections are firmly in place.
-

An unusual image is displayed

- This TV has a built-in Self Test. Makes a diagnosis of picture or sound problems.
➔ [TV Self Test] (Help Menu)
 - Turn the TV off with Mains power On / Off switch, then turn it on again.
 - If the problem persists, initialise all settings.
➔ [Shipping Condition] in [System Menu] (Setup Menu)
-

The image or sound from external equipment are unusual when the equipment is connected via HDMI

- Set [HDMI Auto Setting] (Setup Menu) to [Mode1].
➔ (p. 12)
-

No sound is produced from the connected HDMI equipment

- Set the audio output format of the connected HDMI equipment to PCM.
-

Intermittent Wi-Fi

- Make sure the TV has a network connection with stable Wi-Fi signal from the router and make sure the Wi-Fi password is entered correctly.
 - For details, refer [eHELP] (Search by Purpose > Network > Network Connection > Network Menu).
-

When pushed with a finger, the display panel moves slightly and makes a noise

- There is a little gap around the panel to prevent damage to the panel. This is not a malfunction.
-

Parts of the TV become hot

- Parts of the TV may become hot. These temperature rises do not pose any problems in terms of performance or quality.
-

The child lock for broadcast. The child lock for broadcast password has been forgotten

- Enter new 4 digit PIN code and select [Change PIN code].
 - For details, refer [eHELP] (Search by Purpose > Function > Child Lock).
-

Some programmes cannot be tuned

- Check the antenna (aerial) / cable connection.
-

Control TV with equipment (Smartphone, etc.)

- For details, refer [eHELP] (Search by Purpose > Network > Internet content > Information > Network Setting).
-

About the inquiry

- Please contact your local Panasonic dealer for assistance.

If you make an inquiry from a place where this TV is not present, we cannot answer about contents that require visual confirmation for connection, phenomenon, etc. of this TV itself.

Maintenance

First, remove the mains plug from the mains socket.

Display panel, Cabinet, Pedestal

Regular care:

Gently wipe the surface of the display panel, cabinet, or pedestal by using a soft cloth to remove dirt or fingerprints.

For stubborn dirt:

- (1) First clean the dust from the surface.
- (2) Dampen a soft cloth with clean water or diluted neutral detergent (1 part detergent to 100 parts water).
- (3) Wring out the cloth firmly. (Please note, do not let liquid enter the TV inside as it may lead to product failure.)
- (4) Carefully wipe moisten and wipe away the stubborn dirt.
- (5) Finally, wipe away all the moisture.

Caution

- Do not use a hard cloth or rub the surface too hard, otherwise this may cause scratches on the surface.
- Take care not to subject the surfaces to insect repellent, solvent, thinner or other volatile substances. This may degrade surface quality or cause peeling of the paint.
- The surface of the display panel is specially treated and may be easily damaged. Take care not to tap or scratch the surface with your fingernail or other hard objects.
- Do not allow the cabinet and pedestal to make contact with a rubber or PVC substance for a long time. This may degrade surface quality.

Mains plug

Wipe the mains plug with a dry cloth at regular intervals. Moisture and dust may cause fire or electrical shock.

Specifications

Specification	TH-55HX900Z	TH-65HX900Z
Dimensions (W x H x D)	1 231 mm x 771 mm x 218 mm (With Pedestal) 1 231 mm x 716 mm x 72 mm (TV only)	1 451 mm x 915 mm x 325 mm (With Pedestal) 1 451 mm x 840 mm x 73 mm (TV only)
Mass	18.0 kg Net (With Pedestal) 17.5 kg Net (TV only)	27.0 kg Net (With Pedestal) 26.0 kg Net (TV only)
Power Rating	AC 220-240 V, 50 / 60 Hz, 0.93 A	AC 220-240 V, 50 / 60 Hz, 1.05 A
Normal (Home) mode	87.2 W	98.4 W
Standby power consumption	0.5 W	
Visible screen size (diagonal)	139 cm	164 cm
Display resolution	3 840 (W) x 2 160 (H)	
Panel	LED backlight Liquid Crystal Display	
Sound	Speaker output 20 W (10 W + 10 W)	Headphones / Subwoofer 3.5 mm stereo mini jack x 1
Connection terminals	AV IN VIDEO 1.0 V[p-p] (75 Ω)	AUDIO L - R 0.5 V[rms]
	HDMI1 / 2 / 3 / 4 input TYPE A Connectors HDMI1 / 3 / 4: 4K, Content Type, Deep Colour, x.v.Colour™ • This TV supports "HDAVI Control 5" function.	HDMI2: 4K, Content Type, Audio Return Channel, Deep Colour, x.v.Colour™
	ETHERNET 10BASE-T / 100BASE-TX	
	USB 1 / 2 / 3 USB 1: DC --- 5 V, Max. 900 mA [SuperSpeed USB (USB 3.0)]	USB 2 / 3: DC --- 5 V, Max. 500 mA [Hi-Speed USB (USB 2.0)]
	DIGITAL AUDIO OUT PCM / Dolby Digital, Fibre optic	
Receiving systems / Band name	Satellite TV Digital satellite services Receiver frequency range - 950 MHz to 2150 MHz DiSEqC - Version 1.0	Digital TV 8 MHz VHF / UHF (New Zealand) free-to-air TV broadcast reception
	PAL B / G Reception of Off air broadcast	PAL 60 Hz Playback of NTSC tape from some PAL Video recorders (VCR)
	M.NTSC Playback from M.NTSC Video recorders (VCR)	NTSC Playback from NTSC Video recorders (VCR)
Satellite dish input	Female F-type 75 Ω x 1	
Aerial input	Standard Belling & Lee connector	
Operating conditions	Temperature 0 °C - 35 °C	Humidity 20 % - 80 % RH (non-condensing)
	Built-in wireless LAN	Standard compliance and Frequency range *1 IEEE802.11a/h/ac 5.15 GHz - 5.35 GHz, 5.47 GHz - 5.85 GHz IEEE802.11b/g/n 2.400 GHz - 2.4835 GHz
Bluetooth wireless technology *2	Standard Compliance Bluetooth 4.2	Security WPA2-FSK (TKIP/AES) WPA-PSK (TKIP/AES) WEP (64 bit/128 bit)
		Frequency Range 2.402 GHz - 2.480 GHz

*1: The frequency and channel differ depending on the country.

*2: Not all the Bluetooth compatible devices are available with this TV. Up to 5 devices can be used simultaneously (except bundled remote control).

Note

- Design and Specifications are subject to change without notice. Mass and Dimensions shown are approximate.
- For information about the open source software, refer to [eHELP] (Search by Purpose > Read first > Before use > Licence).

WARRANTY - New Zealand only

WE WARRANT that the Panasonic Television that you have purchased is free from defects in material and workmanship under normal home use and service.

Accordingly, we undertake to repair, or at our option, replace without cost to the owner, either for material or labour, any part which within 12 months from the date of delivery is found to be defective, provided that the appliance has been used for domestic purposes only and in accordance with the instructions given in the Instruction Book and not been subjected to misuse, neglect or installed, dismantled, repaired or serviced by any other than an authorised Panasonic New Zealand Dealer or Panasonic New Zealand Authorised Service Centre.

NOTE

- Before reporting a fault, please ensure that you read the item "Troubleshooting" in the information section of your Panasonic Instruction Book.
- It is important to retain your proof of purchase as this will be required by the serviceman or retailer as proof of purchase date, should service be required.
- In the event of service being required, contact your Panasonic New Zealand retailer or Panasonic New Zealand Authorised Service Centre.

IMPORTANT

Any request for warranty service must be through an Authorised Panasonic New Zealand Service Centre who during the period of the warranty, undertakes to make any necessary adjustment and fit any replacement part supplied by the manufacturer, during normal working hours, or alternatively will arrange for such service to be provided by some other Panasonic New Zealand Authorised Service Centre.

NEW ZEALAND

Distributed in New Zealand by Panasonic New Zealand Limited

18 Sir Woolf Fisher Drive, Highbrook, East Tamaki, Private Bag 14911, Panmure, Auckland

Tel. 09 272 0100

Customer Care Center

Email: Customerservice@nz.panasonic.com

www.panasonic.co.nz

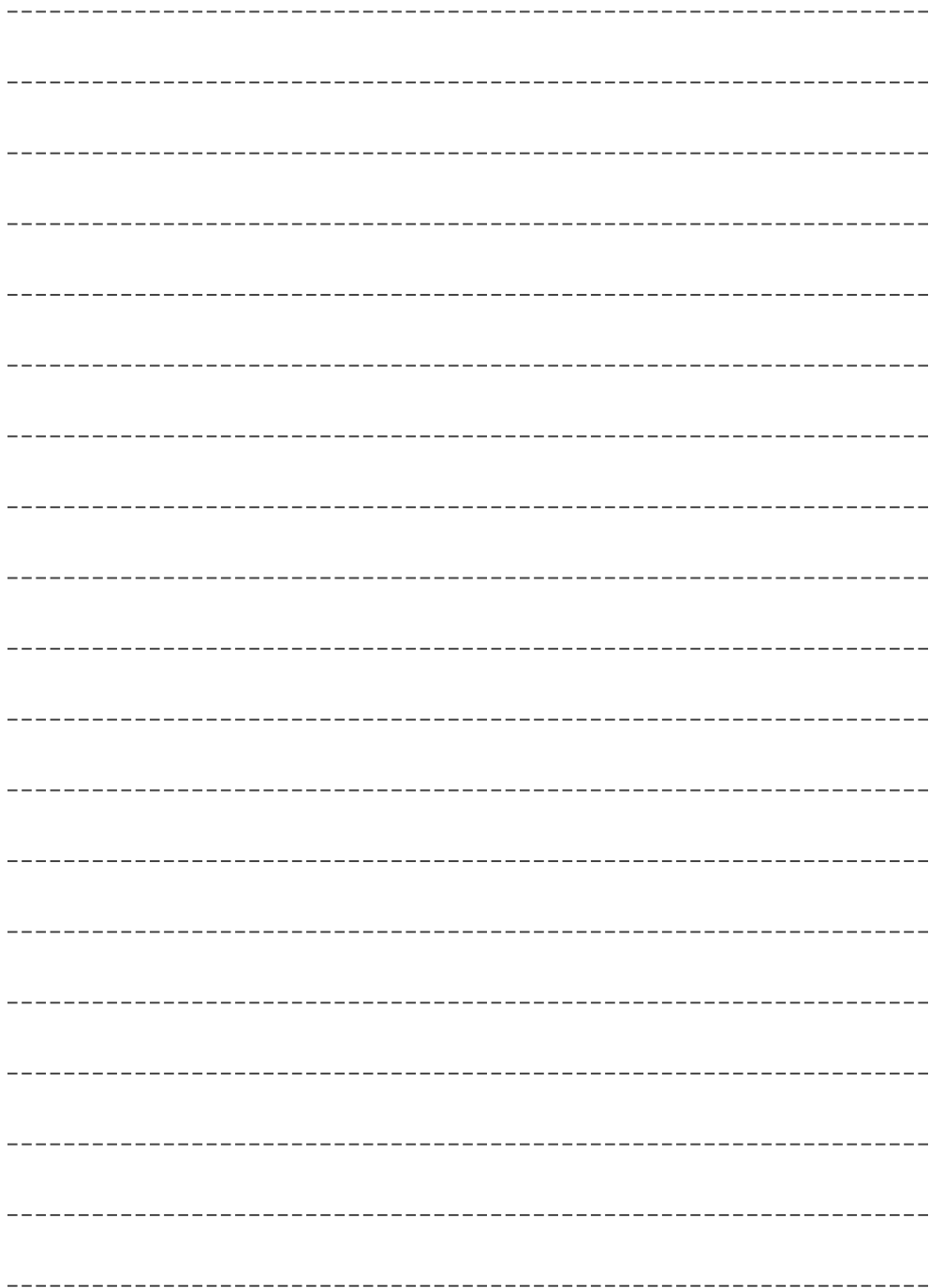

Customer's Record

The model number of this product may be found on the model name plate on the rear panel. The serial number may be found on the model name plate or the serial number label located on side or bottom of the rear panel. You should note this serial number in the space provided below and retain this book, plus your purchase receipt, as a permanent record of your purchase to aid in identification in the event of theft or loss, and for Warranty Service purposes.

Model Number

Serial Number
