

# Panasonic®

## Operating Instructions

### Microwave Oven

Household Use Only

Model No. NN-ST34NW/B



NN-ST34NB

We are glad you have chosen to purchase a PANASONIC microwave oven. Before operating this oven, please read these instructions carefully and completely, and keep them for further reference.

If you have never used a microwave oven before, you will realise that a microwave oven uses a totally different method of converting energy into heat. This requires an understanding of what exactly happens to food when placed in the oven. This is explained in the following pages.

After reading the introductory chapter, I am sure you will be able to master the basic technique and thereby develop a firm understanding of your new oven.

Start experimenting now, and enjoy the first class results you will achieve by using your new microwave oven.

Panasonic Australia Pty Ltd  
1 Innovation Road  
Macquarie Park  
NSW 2113



PANASONIC NZ LTD  
CUSTOMER CARE CENTRE  
18 Sir Woolf Fisher Drive  
Highbrook, Auckland 2013  
Private Bag 14911  
Panmure, Auckland

Phone: (09) 272-0178

Fax: (09) 272-0134

Email: [customerservice@nz.panasonic.com](mailto:customerservice@nz.panasonic.com)

Website: [www.panasonic.co.nz/support](http://www.panasonic.co.nz/support)

The serial number of this product may be found on the identification label. You should note the model number and serial number of this oven in the space provided and retain this book as a permanent record of your purchase for future reference.

MODEL NUMBER \_\_\_\_\_

SERIAL NUMBER \_\_\_\_\_

DATE OF PURCHASE \_\_\_\_\_

# Contents

Important safety instructions.....	2
General guidelines.....	7
Containers to use .....	9
Parts of your oven .....	11
Control panel .....	12
Setting the clock .....	13
Child safety lock .....	13
Microwave cooking and defrosting .....	14
Multi-stage cooking.....	16
Quick 30 feature .....	17
Add time feature .....	17
Using the timer .....	18
Auto programmes.....	20
Auto defrost .....	20
Auto menu .....	22
Cooking and reheating guidelines .....	25
Questions and answers .....	26
Care of your oven .....	27
Specifications .....	28
Panasonic Warranty (Australia).....	29
Panasonic Warranty (New Zealand).....	31

**Thank you for purchasing a Panasonic appliance.**

**Important Safety Instructions:**

Before operating this oven, please read these instructions and precautions carefully and keep for future reference.

# Important safety instructions

## WARNING

1. The door seals and seal areas should be cleaned with a damp cloth.  
The appliance should be inspected for damage to the door seals and door seal areas and if these areas are damaged the appliance should not be operated until it has been repaired by a service technician trained by the manufacturer.
2. Liquids and other foods must not be heated in sealed containers since they are liable to explode.
3. **WHEN YOUR OVEN REQUIRES SERVICING**, call your local Panasonic engineer (Customer Support). It is hazardous for anyone other than a competent person to carry out any service or repair operation which involves the removal of a cover which gives protection against exposure to microwave energy.

## CAUTION

1. Do not attempt to tamper with or make any adjustments or repairs to the door, control panel housing, safety interlock switches or any other part of the oven. Do not remove the outer panel from the oven which gives protection against exposure to microwave energy. Repairs should only be done by a qualified service person.

2. Do not operate this appliance if it has a damaged CORD OR PLUG, if it is not working properly, or if it has been damaged or dropped. It is dangerous for anyone other than a service technician trained by the manufacturer to perform repair service.
3. If the supply cord is damaged, it must be replaced by the manufacturer, its service agent or similarly qualified person in order to avoid a hazard.
4. This appliance is not intended for use by persons (including children) with reduced physical, sensory or mental capabilities, or lack of experience and knowledge unless they have been given supervision or instruction concerning use of the appliance by a person responsible for their safety.  
Children should be supervised to ensure that they do not play with the appliance.
5. The microwave oven is intended for heating food and beverages. Drying of food, newspaper or clothing and heating of warming pads, slippers, sponges, damp cloth and similar may lead to risk of injury, ignition or fire.
6. Before use, check that utensils/containers are suitable for use in microwave ovens.
7. The oven will only operate with the door closed.
8. When the oven is not being used, do not store any objects other than oven accessories inside the oven in case it is accidentally turned on.

9. The appliance shall not be operated WITHOUT FOOD IN THE OVEN.  
Operation in this manner may damage the appliance.
10. If smoke or a fire occurs in the oven, press Stop/Reset and leave the door closed in order to stifle any flames.  
Disconnect the power cord, or shut off the power at the fuse or the circuit breaker panel.
11. The oven lamp must be replaced by a service technician trained by the manufacturer. Do not attempt to remove the outer casing from the oven.

## Installation

### Examine your microwave oven

Unpack the oven, remove all packing material, and examine the oven for any damage such as dents, broken door latches or cracks in the door. If you find any damage, notify your dealer immediately. Do not install a damaged microwave oven.

### Earthing Instructions

**IMPORTANT: THIS UNIT HAS TO BE PROPERLY EARTHED FOR PERSONAL SAFETY.**

If your AC outlet is not earthed, it is the personal responsibility of the customer to have it replaced with a properly earthed wall socket.

## Operation Voltage

The voltage has to be the same as specified on the label on the oven. If a higher voltage than specified is used, it may cause a fire or other damages.

WE CERTIFY THAT THIS MICROWAVE OVEN HAS BEEN INSPECTED AND COMPLIES WITH THE REQUIREMENTS OF REGULATION 3, SUBCLAUSE(2), OF THE MICROWAVE OVENS REGULATIONS 1982.

(This statement applicable only to New Zealand.)

## Placement of the oven

This appliance is intended to be used in household and similar applications such as:

- staff kitchen areas in shops, offices and other working environments;
- farm houses;
- by clients in hotels, motels and other residential environments;
- bed and breakfast type environments.

1. Place the oven on a flat and stable surface, more than 85 cm above the floor.

The appliance is freestanding type and shall not be placed in a cabinet.

2. When this oven is installed, it should be easy to isolate the appliance from the electricity supply by pulling out the plug or operating a circuit breaker.
3. For proper operation, ensure a sufficient air circulation for the oven.

# Important safety instructions

## Counter-top use:

- a. Allow 15 cm of space on the top of the oven, 10 cm at the back and on 5 cm both sides.
- b. If one side of the oven is placed flush to a wall, the other side or top must not be blocked.

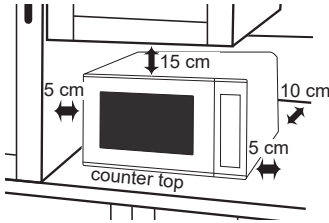

4. Do not place this oven near an electric or gas cooker range.
5. The feet should not be removed.
6. This oven is only for household usage. Do not use outdoors.
7. Avoid using the microwave oven in high humidity.
8. The power cord should not touch the outside of the oven. Keep the cord away from hot surfaces. Do not let the cord hang over the edge of a table or work top. Do not immerse the cord, plug or oven in water.
9. Do not block the air vents. If these openings are blocked during operation the oven may overheat. In this case the oven is protected by a thermal safety device and resumes operation only after cooling down.
10. When it becomes necessary to replace the oven light, please consult your dealer.

## Accessories

The oven comes equipped with a variety of accessories. Always follow the directions given for use of the accessories.

### Roller ring

- Do not remove the roller ring from the cavity floor.
- The roller ring and the oven floor should be cleaned frequently to prevent noise and build-up of remaining food.
- The roller ring must always be used for cooking together with the glass tray.
- If you accidentally remove the roller ring, place the roller ring gently into the hole in the centre of the oven and locate it on the spindle beneath. Flat processing is applied on the spindle to firmly hold the roller ring during operation.

### Glass tray

- Always operate the oven with the roller ring and glass tray in place.
- Only use the glass tray specifically designed for this oven. Do not substitute with any other glass tray.
- If the glass tray is hot, let it cool before cleaning or placing in water.
- The glass tray can turn in either direction.
- If the food or cooking vessel on the glass tray touches the oven walls and stops the tray rotating, the tray will automatically rotate in the opposite direction. This is normal. Open oven door, reposition the food and restart.

- Do not cook foods directly on the glass tray. Always place food in a microwave safe dish.
- While cooking, the glass tray may vibrate. This will not affect cooking performance.

**Important**

If the recommended cooking time is exceeded, the food will be spoiled and in extreme circumstances could catch fire and possibly damage the interior of the oven.

**Short cooking time**

As microwave cooking time is much shorter than other cooking methods, it is essential that recommended cooking time is not exceeded without first checking the food.

Factors that may affect cooking time are: preferred degree of cooking, starting temperature, altitude, volume, size and shape of foods and utensils used. As you become familiar with the oven, you will be able to adjust these factors.

It is better to undercook rather than overcook foods. If food is undercooked, it can always be returned to the oven for further cooking. If food is overcooked, nothing can be done. Always start with minimum cooking time.

**Small quantities of food**

Take care when heating small quantities of food as these can easily burn, dry out or catch fire if cooked too long. Always set short cooking time and check the food frequently.

**Foods low in moisture**

Take care when heating foods low in moisture, e.g. bread items, chocolate, popcorn, biscuits and pastries. These can easily burn, dry out or catch on fire if cooked too long. We do not recommend heating foods low in moisture such as popcorn or bread.

This oven has been developed for food use only.

We do not recommend to use for heating non food items such as wheat bags or hot water bottles.

**Reheating**

It is essential that reheated food is served “piping hot”.

Remove the food from the oven and check that it is “piping hot”, i.e. steam is being emitted from all parts and all sauce is bubbling. (You may choose to check the food has reached 72 °C with a food thermometer – but remember do not use this thermometer inside the microwave.)

For foods that cannot be stirred, e.g. lasagne, shepherds pie, the centre should be cut with a knife to test it is well heated through. Even if a manufacturer’s packet instructions have been followed always check the food is piping hot before serving and if in doubt return your food to the oven for further heating.

**Standing time**

Standing time refers to the period at the end of cooking or reheating when food is left before being eaten, i.e. it is a rest time which allows the heat in the food to continue to conduct to the centre, thus eliminating cold spots.

# Important safety instructions

## Lids

Always remove the lids of jars and containers and takeaway food containers before you microwave the food. If the lid remains, then steam and pressure might build up inside and cause an explosion even after the microwave cooking has stopped.

## Babies bottles and food jars

When reheating babies bottles always remove top and teat. Liquid at the top of the bottle will be much hotter than that at the bottom and must be shaken thoroughly before checking the temperature. This should be carried out before consumption to avoid burns. See page 25.

## Boiled eggs

Eggs in their shell and whole hard-boiled eggs should not be heated in microwave ovens since they may explode even after microwave heating has ended.

## Foods with skins

Potatoes, apples, egg yolk, whole vegetables and sausages are examples of food with non porous skins. These must be pierced using a fork before cooking to prevent bursting.

## Paper and plastic

When heating food in plastic or paper containers, keep an eye on the oven due to the possibility of ignition. Do not use wire twist-ties with roasting bags as arcing will occur.

Do not use re-cycled paper products, e.g. Kitchen roll unless they say they are specifically designed for use in a microwave oven. These products contain impurities which may cause sparks and/or fires when used.

## Liquids

Microwave heating of beverages can result in delayed eruptive boiling, therefore care should be taken when handling the container. To prevent the possibility of sudden boil the following steps should be taken:

- a) Avoid using straight-sided containers with narrow necks.
- b) Do not overheat.
- c) Stir the liquid before placing the container in the oven and again halfway through the heating time.
- d) After heating, allow to stand in the oven for a short time, stirring again before carefully removing the container.

## Deep fat frying

Do not attempt to deep fat fry in your oven.

## Arcing

Arcing may occur accidentally if a metal container has been used or the incorrect weight of food is used. Arcing is flashes of blue light seen in the microwave oven. If this occurs, stop the machine immediately. If the oven is left unattended and this continues it can damage the machine.

## Meat thermometer

Use a meat thermometer to check the degree of cooking of joints and poultry only when meat has been removed from the microwave. If undercooked, return to the oven and cook for a few more minutes at the recommended power level. Do not leave a conventional meat thermometer in the oven when microwaving.



# General guidelines

## CLEANING

As microwaves work on food particles, keep your oven clean at all times. Stubborn spots of food can be removed by using a microwave spray cleaner, sprayed onto a soft cloth. Always wipe the oven dry after cleaning.

Refer to “Care of your oven” on page 27 for details on cleaning.

The warranty only applies if the product has been used in accordance with the operating instructions under normal use and reasonable care.

## STANDING TIME

Dense foods e.g. meat, jacket potatoes and cakes, require standing time (inside or outside of the oven) after cooking, to allow heat to finish conducting to the centre of the food to cook through completely. Wrap meat joints and jacket potatoes in aluminium foil while standing. Meat joints need approx. 10–15 minutes, jacket potatoes 5 minutes. Other foods such as plated meals, vegetables, fish etc. require 2–5 minutes standing. If food is not cooked after standing time, return to the oven and cook for additional time. After defrosting food, standing time should also be allowed.

## QUANTITY



Small quantities cook faster than large quantities, and small meals will reheat more quickly than large portions.

## SPACING

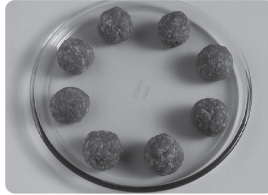

Foods cook more quickly and evenly if spaced apart. NEVER pile foods on top of each other.

## PIERCING



The skin or membrane on some foods will cause steam to build up during cooking.

These foods must be pierced or a strip of skin should be peeled off before cooking to allow the steam to escape. Eggs, potatoes, apples, sausages etc, will all need to be pierced before cooking. DO NOT ATTEMPT TO BOIL EGGS IN THEIR SHELLS.

## COVERING



Cover foods with microwave cling film or a lid. Cover fish, vegetables, casseroles, soups. Do not cover cakes, sauces, jacket potatoes or pastry items.

# General guidelines

## MOISTURE CONTENT

Many fresh foods e.g. vegetables and fruit, vary in their moisture content throughout the season. For this reason cooking time may have to be adjusted. Dry ingredients e.g. rice, pasta, can dry out during storage so cooking time may differ.

## DENSITY

Porous airy foods heat more quickly than dense heavy foods.

## SHAPE



Even shapes cook evenly. Food cooks better by microwave when in a round container rather than square.

## STARTING TEMPERATURE

The colder the food, the longer it takes to heat up. Food from a fridge takes longer to reheat than food at room temperature.

## LIQUIDS



All liquids must be **STIRRED BEFORE, DURING AND AFTER** heating. Water must be stirred before and during heating, to avoid eruption. Do not heat liquids that have previously been boiled. **DO NOT OVERHEAT.**

## TURNING AND STIRRING

Some foods require stirring during cooking. Meat and poultry should be turned after half of the cooking time.

## ARRANGING

Individual foods e.g. chicken portions or chops, should be placed on a dish so that the thicker parts are towards the outside.

## CHECKING FOOD



It is essential that food is checked during and after a recommended cooking time, even if an **AUTO PROGRAMME** has been used (just as you would check food cooked in a conventional oven). Return the food to the oven for further cooking if necessary.

## DISH SIZE



Follow the dish sizes given in the recipes, as these affect the cooking and reheating times. A quantity of food spread in a bigger dish cooks and reheats faster.

## CLING FILM

Cling film helps keep the food moist and the trapped steam assists in speeding up cooking time. Pierce before cooking to allow excess steam to escape. Always take care when removing cling film from a dish as the build-up of steam will be very hot.

## Containers to use

Choosing the correct container is a very important factor in deciding the success or failure of your cooking.

### OVEN GLASS

Glass that is heat resistant e.g. Pyrex®, is ideal, and can be used.

Do not use glass which may crack due to the heat from the food. Do not use lead crystal which may crack or arc.



### CHINA AND CERAMIC

Glazed china plates, saucers, bowls, mugs and cups can be used if they are heat resistant.

Porcelain and ceramic are also ideal. Fine bone china should only be used for reheating for short period of time, otherwise the change in temperature may crack the dish or craze the finish. Do not use dishes with a metal rim or pattern. Do not use jugs or mugs with glued handles, since the glue can melt in a microwave.



### POTTERY, EARTHENWARE, STONEWARE

Only use if completely glazed. Do not use if partially glazed or unglazed, as they are able to absorb water which will absorb microwave energy, making the container very hot and slowing down the cooking of food.



### FOIL/METAL CONTAINERS

NEVER ATTEMPT TO COOK IN FOIL OR METAL containers – the microwaves cannot pass through and the food will not heat evenly – this may also damage your oven. Use wooden kebab sticks instead of metal skewers.



### CLING FILM

Use microwave cling film to cover food that is to be reheated, or cooked, ON MICROWAVE ONLY taking care to avoid the film being in direct contact with the food.



## Containers to use

### PLASTIC

Many plastic containers are designed for microwave use. Only use containers if they are designed for microwave use. Do not use Melamine as it will scorch. Do not use plastic for cooking foods high in sugar or fat or foods that require long cooking time e.g. brown rice. Never cook in margarine containers or yogurt pots, as these will melt with the heat from the food.



### PAPER

Plain white kitchen paper (kitchen towel) can be used for covering blind pastry cases and for covering bacon to prevent splattering **ONLY USE FOR SHORT COOKING TIME. NEVER RE-USE A PIECE OF KITCHEN TOWEL.** Avoid kitchen paper containing manmade fibers. Check that branded re-cycled kitchen towel is recommended for microwave use. Do not use waxed or plastic coated cups as the finish may melt in the oven. Greaseproof paper can be used to line the base of dishes and to cover fatty foods. White paper plates can be used for **SHORT REHEATING TIMES, ON MICROWAVE ONLY.**



### WICKER, WOOD, STRAW BASKETS

Do not use these items in your microwave. With continued use and with prolonged exposure they will crack and could ignite.



### ALUMINIUM FOIL

Small amounts of smooth aluminium foil can be used to **SHIELD** joints of meat during defrosting. As the microwaves cannot pass through the foil this prevents the shielded parts from overcooking or overdefrosting. The foil must not touch the sides or roof of the oven, as this may cause arcing and damage your oven.



### ROASTING BAGS

These are useful when slit up one side to tent a joint of meat when roasting by power and time. **DO NOT USE THE METAL TWISTS SUPPLIED.**

# Parts of your oven

## 1. Door Release Button

Press to open the door. Opening the door during cooking will stop the cooking process without cancelling the programme. It is quite safe to open the door at any time during a cooking programme and there is no risk of microwave exposure. Cooking resumes after the door is closed and Start/Set is pressed.

## 2. Oven window

## 3. Air vent

## 4. Microwave feed guide (Do not remove.)

## 5. External air vents

## 6. Control panel

## 7. Power supply cord

## 8. Plug

## 9. Glass tray

## 10. Roller ring

## 11. Menu label

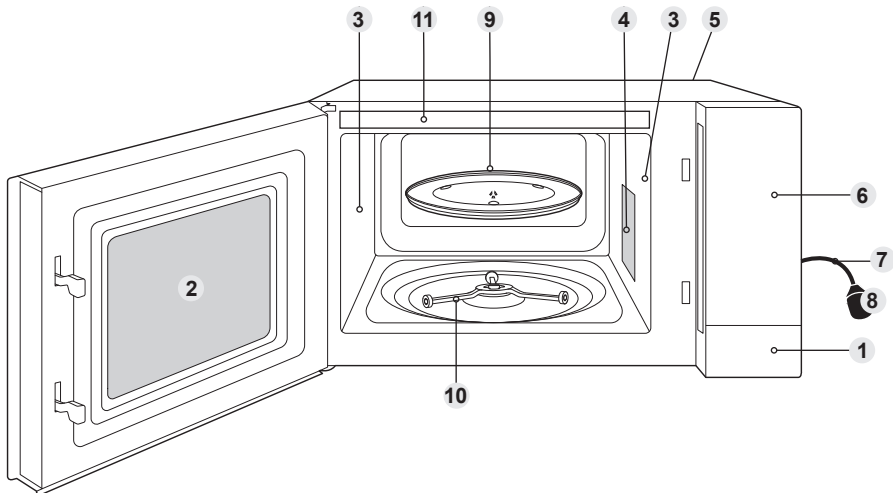

Identification and caution labels are attached on the oven.

### ■ Note

This illustration is for reference only.

# Control panel

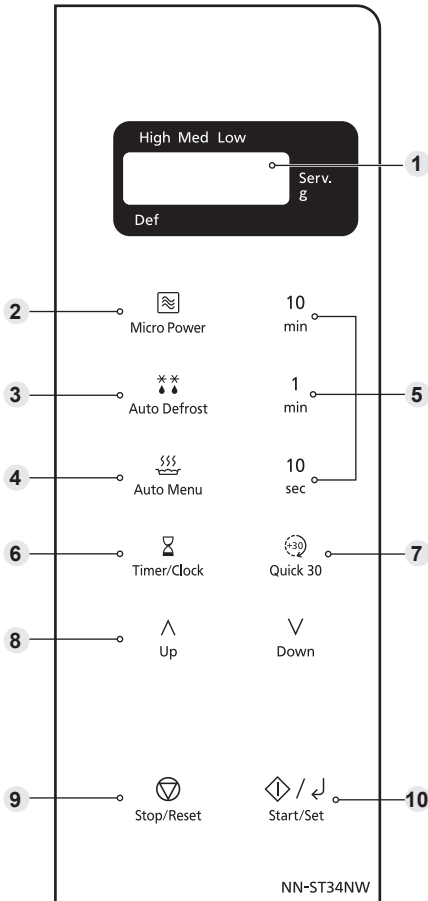

- 1 Display window
- 2 Micro Power pad
- 3 Auto Defrost pad
- 4 Auto Menu pad
- 5 Time pads
- 6 Timer/Clock pad
- 7 Quick 30 pad
- 8 Up/Down pads

## 9 Stop/Reset pad Before Cooking

One press clears your instructions.

## During Cooking

One press temporarily stops the cooking process. Another press cancels all your instructions and a dot or the time of day will appear in the display.

## 10 Start/Set pad

One press allows oven to begin operation. If door is opened or Stop/Reset is pressed once during oven operation, Start/Set must be pressed again to restart oven.

- Your control panel may have differences in appearance, but the words on the pads and functionality will be the same.

### ■ Beep sound

When a pad is pressed correctly a beep will be heard. If a pad is pressed and no beep is heard, the unit has not or cannot accept the instruction. The oven will beep twice between programmed stages. At the end of any complete programme, the oven will beep 5 times.

### ■ Note

If Start/Set is not pressed for 6 minutes after cooking programme setting, the oven will automatically cancel the cooking programme. The display will revert back to clock or dot.

# Setting the clock

When the oven is plugged in for the first time, “88.88” appears in display.



**Press Timer/Clock twice.**  
Hour starts to blink.

**Press Up/Down to set hours.**

**Press Start/Set.**  
Minute starts to blink.

**Press Up/Down to set minutes.**



**Press Start/Set.**  
Time of day is now locked into the display.

## ■ Notes

1. To reset the clock, repeat the whole step above.
2. The clock will keep the time of day as long as the oven is plugged in and electricity is supplied.
3. This is a 12 hour clock.

# Child safety lock

This feature will make the oven controls inoperable; however, the door can be opened. Child safety lock can be set when the display shows a dot or the time.

**To Set:**



**Press Start/Set 3 times within 10 seconds.**  
The clock will disappear. Actual time will not be lost. “Child” is indicated in the display.

**To Cancel:**



**Press Stop/Reset 3 times within 10 seconds.**  
The clock will reappear in the display.

# Microwave cooking and defrosting

The glass tray must always be in position when using the oven.



**Press Micro Power to select the desired power level.**

**Set the cooking time.**  
Refer to “Setting the cook time/timer time” on page 15.

**Press Start/Set.**  
The time counts down in the display.

Press	Power Level	Wattage	Max. time available	Example of Use
once	High	900 W	30 minutes	Boil water. Cook fresh fruit, vegetables, rice, pasta and noodles.
twice	Med-high	500 W	99 minutes 50 seconds	Cook poultry, meat, cakes and desserts. Heat milk.
3 times	Medium	400 W	99 minutes 50 seconds	Cook eggs, cheeses, fish, pot roasts, casseroles and meat loaves. Melt chocolate.
4 times	Defrost	200 W	99 minutes 50 seconds	Thaw foods.
5 times	Low	100 W	99 minutes 50 seconds	Keep cooked foods warm, simmer slowly.

## ■ Notes

1. The oven will automatically work on High microwave power if a cooking time is entered without the power level previously being selected.
2. While cooking, the glass tray may vibrate. This will not affect cooking performance.
3. For MULTI-STAGE COOKING, refer to page 16.
4. STANDING TIME can be programmed after microwave power and time setting. Refer to page 18.
5. DO NOT cook with any metal accessory in the oven.
6. Always check the food during defrosting by opening the door then restarting. It is not necessary to cover food during defrosting. To ensure an even result, stir, turn or separate several times during defrosting. For large joints and poultry, turn halfway through defrosting and protect ends and tips with aluminium foil. Refer to Defrosting guidelines on page 21 for details.
7. When the microwave oven is operated at High microwave power for long time, the microwave oven automatically adjust the power to protect the components of the microwave oven.



## ■ Setting the cook time/timer time

When you set the cook time or the timer time, use following keys according to your needs.



Press each Time pad repeatedly according to the time value you want to set.

Press Quick 30 to set cooking time in 30 seconds increments.



After you enter a time value with each Time pad or Quick 30, you can adjust the time values with the Up/Down pads.

# Multi-stage cooking

This feature allows you to programme up to 3 stages of cooking continuously.

**Example:** To continually set High power for 2 minutes, Medium power for 3 minutes and Low power for 2 minutes.

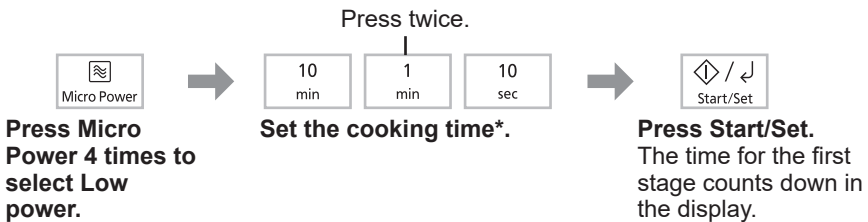
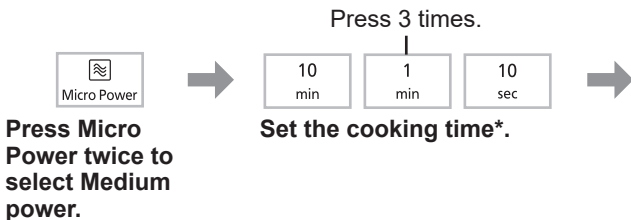
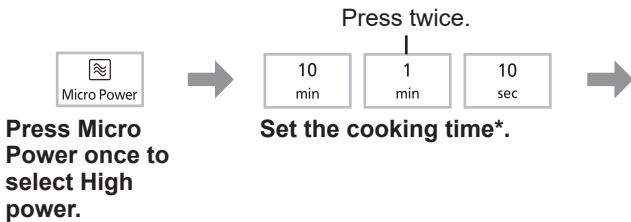

\* Refer to “Setting the cook time/timer time” on page 15.

## ■ Notes

1. AUTO PROGRAMMES cannot be used with MULTI-STAGE COOKING.
2. When operating, 2 beeps will sound between each stage, and 5 beeps will sound after all stages have finished.
3. High MICROWAVE power can be set only once in MULTI-STAGE COOKING.

## Quick 30 feature

This feature allows you to set cooking time in 30 seconds increments up to 5 minutes at High power.



**Press Quick 30 until the desired cooking time appears in the display.**

**Press Start/Set.**  
The time counts down in the display.

## Add time feature

This feature allows you to add cooking time during cooking.



**During cooking, press 1 min or 10 sec.**  
Cooking time will be added up to 5 minutes.

### ■ Note

ADD TIME feature is not available for AUTO PROGRAMMES.

# Using the timer

This feature operates as a KITCHEN TIMER or allows you to programme the STANDING TIME/DELAY START.

## Kitchen timer

**Example:** To count 5 minutes.

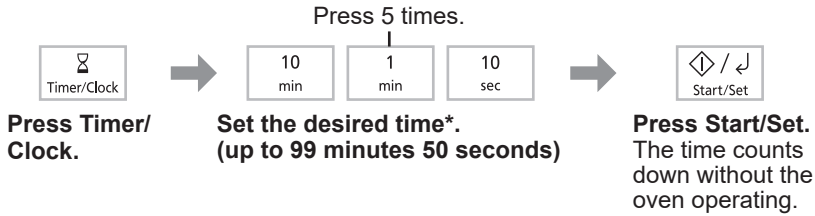

\* Refer to “Setting the cook time/timer time” on page 15.

## Standing time

**Example:** To stand for 5 minutes after cooking at Medium power for 3 minutes.

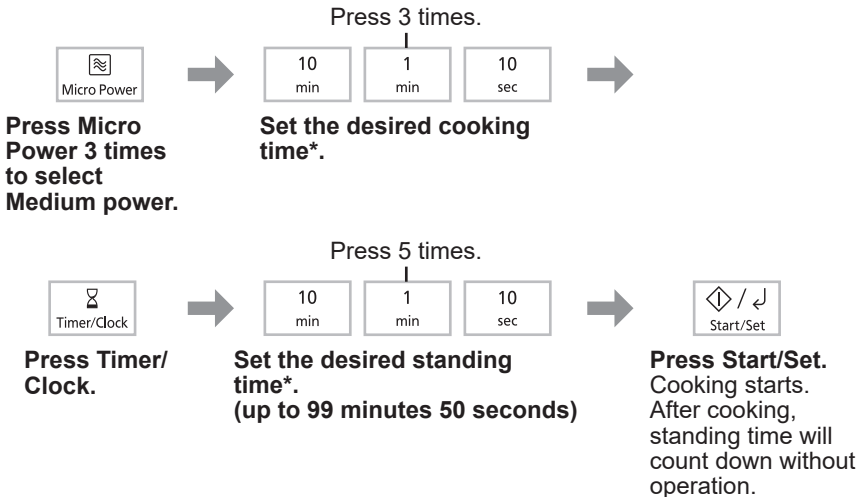

\* Refer to “Setting the cook time/timer time” on page 15.

## Delay start

**Example:** To start cooking at Medium power for 3 minutes after 5 minutes of standing time.

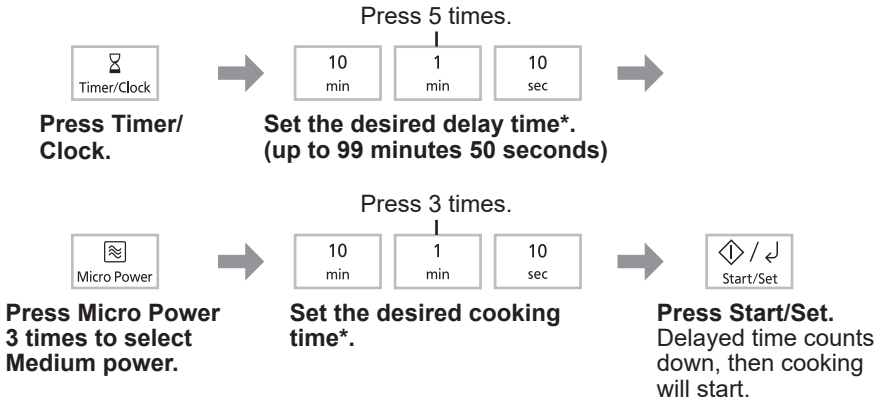

\* Refer to "Setting the cook time/timer time" on page 15.

### ■ Notes

1. MULTI-STAGE COOKING can be programmed including STANDING TIME or DELAY START.
2. Even if the oven door is opened during KITCHEN TIMER, STANDING TIME or DELAY START, the time in the display window will continue to count down.
3. STANDING TIME/DELAY START cannot be programmed before/after any AUTO PROGRAMME.

# Auto programmes

With this feature you can defrost/reheat/cook food according to the weight. Select the category and set the weight of the food. The weight is programmed in grams. The oven determines MICROWAVE power level and cooking time automatically. For quick selection, the weight starts from the most commonly used weight for each category. Do not include the weight of any added water or the container weight.

## ■ Notes

1. Always operate the oven with the roller ring and glass tray in place.
2. The AUTO PROGRAMMES must ONLY be used for foods described.
3. Only defrost/cook foods within the weight ranges described.
4. Always weigh the food rather than relying on the package information.
5. Most foods benefit from a STANDING TIME. After cooking with an AUTO PROGRAMME, allow heat to continue conducting to the centre.





## Auto defrost



**Select the desired Auto Defrost programme.**  
The AUTO PROGRAMME number appears in the display.

**Set the weight of the frozen food.**  
The weight counts up/down in 10 g increments.

**Press Start/Set.**  
Remember to stir or turn the food during defrosting.

Programme	Instructions
<p><b>1. Small Pieces</b></p>   1 press	<p><b>Weight:</b> 200 - 1000 g</p> <p>For defrosting small pieces of meat, escallop, sausages, minced meat, steak, chops, fish fillets (each 100 g to 400 g). Press Auto Defrost once. Set the weight of the food and press Start/Set. Turn and shield at beeps. Allow to stand for 15 to 30 minutes.</p>
<p><b>2. Big Piece</b></p>   2 presses	<p><b>Weight:</b> 600 - 1600 g</p> <p>For defrosting big piece of meat, whole chicken, meat joint. Press Auto Defrost twice. Set the weight of the food and press Start/Set. Whole chicken and meat joint will require shielding during defrosting. Protect wings, breast and fat with smooth pieces of aluminium foil secured with cocktail sticks. Do not allow the foil to touch the walls of the oven. Standing time of 1 to 2 hours should be allowed before cooking, so that the centre of the food thaws out. Turn and shield at beeps.</p>

Programme	Instructions
<p data-bbox="150 240 311 264"><b>3. Bread/Cake</b></p>  <div data-bbox="140 363 213 405" style="border: 1px solid black; padding: 2px; display: inline-block;">           *** Auto Defrost         </div> <p data-bbox="221 373 311 397">3 presses</p>	<p data-bbox="353 189 575 213"><b>Weight:</b> 100 - 600 g</p> <p data-bbox="353 221 992 405">For defrosting bread (whole, slices, rolls) and cakes. Cream cakes and iced cakes are unsuitable for this programme. Place the bread or cake on a large plate or shallow dish. Press Auto Defrost 3 times. Set the weight of the food and press Start/Set. Turn at beeps. Allow bread to stand for 10 (white light bread) to 30 minutes (dense rye bread). Cut large loaves in half during standing time.</p>

## Defrosting guidelines

### For best results:

1. Place foods in a suitable container. Meat joints and chicken should be placed on an upturned saucer.
2. Check food during defrosting, as foods vary in their defrosting speed.
3. It is not necessary to cover the whole food (see point 6).
4. Always turn or stir the food especially when the oven "beeps". Protect ends and tips with aluminium foil to avoid overcooking if necessary (see point 6).
5. Minced meat, chops and other small items should be broken up or separated and placed in a single layer.
6. Shielding prevents food from cooking. It is essential when defrosting chicken and joints of meat.  
The outside thaws out first, so protect wings/breast and fat with smooth pieces of aluminium foil secured with cocktail sticks.
7. Allow standing time so that the centre of the food thaws out (minimum of 1 hour for joints of meat and whole chicken).



Arrange food in a single layer.



Turn or break up food as soon as possible.



Shield chicken and joints of meat.

# Auto programmes

## Auto menu



**Select the desired Auto Menu programme\*.**  
The AUTO PROGRAMME number appears in the display.

**Press Start/Set to confirm the setting.**





**Set the weight of the food.**  
The weight counts up/down in 10 g increments.

**Press Start/Set.**  
The time counts down in the display.











\* After press the Auto Menu pad, you can also use the Up/Down pads to select the Auto Menu programme.

### ■ Note



As some variations may occur in food, check that food is thoroughly cooked and piping hot before serving.

Programme	Instructions
<p><b>1. Chilled Meal</b></p>    1 press	<p><b>Weight:</b> 200 - 800 g</p> <p>For reheating a pre-cooked meal. All foods must be pre-cooked. Foods should be at refrigerator temperature approx. +5 °C. Reheat in container as purchased. Follow manufacturer's directions for preparation. If transferring food to a dish, cover with pierced cling film. Place container on glass tray. Press Auto Menu once and press Start/Set. Set the weight of the food and press Start/Set. Stir at beeps. Stir again at end of programme and allow a few minutes standing time. Large pieces of meat/fish in a thin sauce may require longer cooking. This programme is not suitable for starchy foods such as rice, noodles or potatoes. Meals in irregular bowl shaped containers may need longer cooking.</p>
<p><b>2. Frozen Meal</b></p>    2 presses	<p><b>Weight:</b> 300 - 600 g</p> <p>For reheating a frozen pre-cooked meal. All foods must be pre-cooked and frozen (-18 °C). Reheat in container as purchased. Follow manufacturer's directions for preparation. If transferring food to a dish, cover with pierced cling film. Place container on glass tray. Press Auto Menu twice and press Start/Set. Set the weight of the food and press Start/Set. Stir at beeps and cut the blocks into pieces. Stir again at end of programme and allow a few minutes standing time. Large pieces of meat/fish in a thin sauce may require longer cooking. This programme is not suitable for starchy foods such as rice, noodles or potatoes. Meals in irregular bowl shaped containers may need longer cooking.</p>



Programme	Instructions
<p><b>3. Fresh Vegetables</b></p>   3 presses	<p><b>Weight:</b> 100 - 800 g</p> <p>For cooking fresh vegetables like carrots, broccoli, cauliflower and green beans. Place prepared vegetables in a suitable sized container. Sprinkle with 1 tbsp water per 100 g vegetables. Cover with cling film. Pierce cling film with a knife once in the centre and 4 times around the edge. Press Auto Menu 3 times and press Start/Set. Set the weight of the food and press Start/Set. Stir at beeps.</p>
<p><b>4. Frozen Vegetables</b></p>   4 presses	<p><b>Weight:</b> 100 - 800 g</p> <p>For all types of frozen vegetables, like frozen peas, sweetcorn or mixed vegetables. Place prepared vegetables into a suitable size microwave safe casserole and add 2-6 tbsp of water if desired. Cover with a well fitting lid. Place the casserole on glass tray. Press Auto Menu 4 times and press Start/Set. Set the weight of the food and press Start/Set. Stir at beeps. At the end of cooking, let it covered and stand for 3 to 5 minutes.</p>
<p><b>5. Fresh Fish</b></p>   5 presses	<p><b>Weight:</b> 200 - 700 g</p> <p>For cooking fresh fish filets and steaks. Place in a suitable sized container. Add 1-3 tbsp liquid. Cover with cling film. Pierce cling film once in the centre and 4 times around the edge. Press Auto Menu 5 times and press Start/Set. Set the weight of the food and press Start/Set. Allow a few minutes standing time.</p>
<p><b>6. Potatoes</b></p>   6 presses	<p><b>Weight:</b> 200 - 600 g</p> <p>For cooking potatoes. Pare potatoes well and cut into even size pieces. Place in a suitable size microwave safe casserole and add 1-3 tbsp of water. Cover with lid or cling film. Place the casserole on glass tray. Press Auto Menu 6 times and press Start/Set. Set the weight of the food and press Start/Set. Stir at beeps.</p>
<p><b>7. Chicken</b></p>   7 presses	<p><b>Weight:</b> 200 - 800 g</p> <p>For cooking chicken pieces such as wings, drumsticks, thighs, half breasts etc. Pierce the chicken pieces well with fork before cooking. Place prepared chicken pieces in a suitable size microwave safe dish. Add 1-5 tbsp oil if desired. Cover with cling film pierced twice. Place the dish on glass tray. Press Auto Menu 7 times and press Start/Set. Set the weight of the food and press Start/Set. Turn at beeps.</p>

# Auto programmes

Programme	Instructions															
<p><b>8. Casserole Rice</b></p>    8 presses	<p><b>Weight:</b> 100 - 300 g</p>	<table border="1"> <thead> <tr> <th data-bbox="621 191 710 248">Rice</th> <th data-bbox="710 191 908 248">Recommended Water</th> <th data-bbox="908 191 1002 248">Dish Size</th> </tr> </thead> <tbody> <tr> <td data-bbox="621 248 710 280">100 g</td> <td data-bbox="710 248 908 280">150 ml</td> <td data-bbox="908 248 1002 280">3 litre</td> </tr> <tr> <td data-bbox="621 280 710 312">200 g</td> <td data-bbox="710 280 908 312">300 ml</td> <td data-bbox="908 280 1002 312">3 litre</td> </tr> <tr> <td data-bbox="621 312 710 344">300 g</td> <td data-bbox="710 312 908 344">450 ml</td> <td data-bbox="908 312 1002 344">3 litre</td> </tr> </tbody> </table>	Rice	Recommended Water	Dish Size	100 g	150 ml	3 litre	200 g	300 ml	3 litre	300 g	450 ml	3 litre		
		Rice	Recommended Water	Dish Size												
		100 g	150 ml	3 litre												
		200 g	300 ml	3 litre												
300 g	450 ml	3 litre														
<p>For cooking white rice including short grain, long grain, jasmine rice and basmati rice. Place rice in a suitable size microwave safe casserole. Add recommended water listed above. Allow at least ½ depth of volume for evaporation to prevent boiling over. Cover with lid. Place the casserole on glass tray. Press Auto Menu 8 times and press Start/Set. Set the weight of the food and press Start/Set. Stand 5 minutes after cooking.</p>																

# Cooking and reheating guidelines

Most foods reheat very quickly in your oven by HIGH power. Meals can be brought back to serving temperature in just minutes.

Always check food is piping hot and return to oven if necessary.

As a general rule, always cover wet foods, e.g. soups, casseroles and plated meals.

Do not cover dry foods e.g. bread rolls, mince pies, sausage rolls, etc.

Remember when cooking or reheating any food that it should be stirred or turned wherever possible. This ensures even cooking or reheating on the outside and in the centre.

## MINCE PIES - CAUTION

REMEMBER even if the pastry is cold to the touch, the filling will be piping hot and will warm the pastry through. Take care not to overheat otherwise burning can occur due to the high fat and sugar content of the filling. Check the temperature of the filling before consuming to avoid burning your mouth.

## PUDDINGS AND LIQUIDS - CAUTION

Puddings and other foods high in fats or sugar, e.g. jam, mince pies, must not be over heated. These foods must never be left unattended as with over cooking these foods can ignite. Take great care when reheating these items.

Do not leave unattended.

Do not add extra alcohol.

## BABIES BOTTLES - CAUTION

Milk or formula **MUST** be shaken thoroughly before heating and again at the end and tested carefully before feeding a baby.

For 200-240 ml of milk from fridge temperature, remove top and teat. Heat on HIGH power for 30–50 sec.

**CHECK CAREFULLY BEFORE FEED.**

For 90 ml of milk from fridge temperature, remove top and teat. Heat on HIGH power for 15–20 sec.

**CHECK CAREFULLY BEFORE FEED.**

N.B. Liquid at top of bottle will be much hotter than at bottom.

The bottle must be shaken thoroughly and tested before use.

**WE DO NOT RECOMMEND THAT YOU USE YOUR MICROWAVE TO STERILISE BABIES' BOTTLES.**

If you have a special microwave steriliser, we urge extreme caution, due to the low quantity of water involved. It is vital to follow the manufacturers instructions implicitly.

## PLATED MEALS

Everyone's appetite varies and reheat times depend on meal contents. Dense items e.g. mashed potato, should be spread out well.

If a lot of gravy is added, extra time may be required.

Place denser items to the outside of the plate. Between 2–4 min. on HIGH power will reheat an average portion. Do not stack meals.

## CANNED FOODS

Remove foods from can and place in a suitable dish before heating.

## SOUPS

Use a bowl and stir before heating and at least once through reheat time and again at the end.

## CASSEROLES

Stir halfway through and again at the end of heating.

## Questions and answers

**Q: Why won't my oven turn on?**

A: When the oven does not turn on, check the following:

1. Is the oven plugged in securely?  
Remove the plug from the outlet, wait 10 seconds and reinsert.
2. Check the circuit breaker and the fuse.  
Reset the circuit breaker or replace the fuse if it is tripped or blown.
3. If the circuit breaker or fuse is all right, plug another appliance into the outlet. If the other appliance works, there probably is a problem with the oven. If the other appliance does not work, there probably is a problem with the outlet.  
If it seems that there is a problem with the oven, contact an authorised Service Centre.

**Q: My oven causes interference with my TV. Is this normal?**

A: Some radio and TV interference might occur when you cook with the oven. This interference is similar to the interference caused by small appliances such as mixers, vacuums, blow dryers, etc. It does not indicate a problem with your oven.

**Q: Sometimes warm air comes from the oven vents. Why?**

A: The heat given off from the cooking food warms the air in the oven cavity. This warmed air is carried out of the oven by the air flow pattern in the oven. There are no microwaves in the air. The oven vents should never be blocked during cooking.

**Q: Can I use a conventional oven thermometer in the oven?**

A: The metal in some thermometers may cause arcing in your oven and should not be used in a microwave oven.

**Q: The oven won't accept my programme. Why?**

A: The oven is designed not to accept an incorrect programme. For example, the oven will not accept a 4th stage.

## Care of your oven

1. The oven should be unplugged before cleaning.
2. Clean the inside of the oven, door seals and door seal areas regularly. When food splatters or spilled liquids adhere to the oven walls, door seals and door seal areas wipe off with a damp cloth. Mild detergent may be used if they get very dirty. The use of harsh detergent or abrasive is not recommended. Avoid cleaning the microwave feed guide area situated on the right hand side of the cavity wall.  
**DO NOT USE COMMERCIAL OVEN CLEANERS.**
3. Do not use harsh, abrasive cleaners or sharp metal scrapers to clean the oven door glass since they can scratch the surface, which may result in shattering the glass.
4. The outside oven surface should be cleaned with a damp cloth. To prevent damage to the operating parts inside the oven, water should not be allowed to seep into the ventilation openings.
5. If the Control Panel becomes dirty, clean it with a soft cloth. Do not use harsh detergents or abrasives on the Control Panel. When cleaning the Control Panel leave the oven door open to prevent the oven from accidentally turning on. After cleaning press Stop/Reset to clear display window.
6. If steam accumulates inside or around the outside of the oven door, wipe with a soft cloth. This may occur when the oven is operated under high humidity conditions and in no way indicates a malfunction of the unit.
7. It is occasionally necessary to remove the glass tray for cleaning. Wash the tray in warm soapy water or in a dishwasher.
8. The roller ring and oven cavity floor should be cleaned regularly to avoid excessive noise. Simply wipe the bottom surface of the oven with mild detergent and hot water then dry with a clean cloth. The roller ring may be washed in mild soapy water. Cooking vapours collect during repeated use but in no way affect the bottom surface or roller ring wheels. Do not remove the roller ring from the cavity floor for cleaning.
9. A steam cleaner is not to be used for cleaning.
10. This oven should only be serviced by qualified personnel. For maintenance and repair of the oven contact the nearest authorised dealer.
11. Failure to maintain the oven in a clean condition could lead to deterioration of surfaces that could affect the life of the appliance and possibly result in a hazardous situation.
12. Keep air vents clean at all times. Check that no dust or other material is blocking any of the air vents on the top, bottom or rear of the oven. If air vents become blocked this could cause overheating which would affect the operation of the oven and possibly result in a hazardous situation.

# Specifications

Power Source	230-240 V 50 Hz
Power Consumption	5.4-6.1 A 1300-1400 W
Output	900 W (IEC-60705)
Outside Dimensions	472 (W) × 351 (D) × 280 (H) mm
Oven Cavity Dimensions	329 (W) × 326 (D) × 236 (H) mm
Overall Cavity Volume	25 L
Glass Tray Diameter	288 mm
Operating Frequency	2450 MHz
Net Weight	12 kg

- Weight and Dimensions shown are approximate.
- Specifications subject to change without notice.
- As for the voltage requirement, the production month, country and serial number, please refer to the identification label on the microwave oven.

# Panasonic Warranty (Australia)

## Small Kitchen Appliances 12 Month Warranty from Date of Purchase (“Warranty Period”)

Microwave Oven, Rice Cooker, Bread Maker, Benchtop Oven and Stick Blenders

1. This warranty does not exclude, restrict or modify in any way other rights and remedies under the law which relates to the product, including any nonexcludable statutory guarantees in Australia.
2. Subject to the conditions of this warranty and during the Warranty Period, Panasonic or its Authorised Service Centre will perform the necessary service on the product without charge for parts or labour, if in the opinion of Panasonic, the product is found to be faulty within the Warranty Period.
3. This warranty only applies to Panasonic products purchased in Australia and sold by Panasonic Australia or its Authorised Distributors or Dealers and only where the products are used and serviced within Australia or its territories. Warranty cover only applies to service carried out by a Panasonic Authorised Service Centre and only if valid proof of purchase is presented when warranty service is requested.
4. This warranty only applies if the product has been used in accordance with the manufacturer’s recommendations (as noted in the Operating Instructions) under normal use and reasonable care (in the opinion of Panasonic). The warranty covers normal domestic use only and does not cover damage, malfunction or failure resulting from:
  - (a) misuse, abuse, neglect, accidental damage or modifications;
  - (b) infestation by insects or vermin;
  - (c) incorrect installation, assembly, improper voltage, or mains supply problems;
  - (d) natural disaster or acts of God (e.g. lightening, flood, fire, earthquakes etc);
  - (e) rust or damage caused by exposure to abnormally corrosive conditions;
  - (f) an accessory, component or other equipment not supplied by Panasonic Australia;
  - (g) improper maintenance by the customer (refer to the maintenance section of the Operating Instructions) which includes but is not limited to the failure to undertake the following actions:
    - (i) regular cleaning; and
    - (ii) where filters are included, regular cleaning and replacement of filters where necessary.
  - (h) incorrect operation of the product; and
  - (i) where no actual fault of the product is determined to have occurred, during a customer-initiated service call, and where the perceived problem is explained within the Operating Instructions (including the troubleshooting section) warranty service is not applicable
5. This warranty does not cover the following items unless the fault or defect existed at the time of purchase:
  - (a) Cabinet or Casing Parts
  - (b) Noise or vibration that is considered normal
  - (c) User replaceable Batteries
  - (d) Kneader mounting shaft unit and heads, blades and other accessories
  - (e) Microwave Oven cook plates

6. You will be responsible for costs associated with making the warranty claim where there are costs associated with shipping or handling or travelling outside of the area normally serviced by Panasonic or any repair agent authorised by Panasonic.
7. To the extent permitted by law and subject to your non-excludable statutory rights and guarantees, Panasonic excludes all warranties and liabilities (other than those contained in this warranty) including any liability for loss or damage whether direct or indirect arising from your purchase, use or non-use of the product.
8. In addition to your rights under this warranty, Panasonic products come with consumer guarantees that cannot be excluded under the Australian Consumer Law. You are entitled to a replacement or refund for a major failure and compensation for any reasonably foreseeable loss or damage. You are also entitled to have the product repaired or replaced if the product fails to be of an acceptable quality and the failure does not amount to a major failure.
9. To claim warranty service, when required, you should:
  - Contact Panasonic's Customer Care Centre on 132 600 for Authorised Service Centre information
  - Send or take the product to a Panasonic Authorised Service Centre together with your purchase receipt as a proof of purchase date.

**THIS WARRANTY CARD AND THE PURCHASE DOCKET  
(OR SIMILAR PROOF OF PURCHASE)  
SHOULD BE RETAINED BY THE CUSTOMER AT ALL TIMES**

If you require assistance regarding warranty conditions or any other enquiries, please visit the **Panasonic Australia** website [www.panasonic.com.au](http://www.panasonic.com.au) or contact by phone on **132 600**

*If phoning in, please ensure you have your operating instructions available.*

**Panasonic Australia Pty. Limited**

ACN 001 592 187 ABN 83 001 592 187

1 Innovation Road, Macquarie Park NSW 2113

[www.panasonic.com.au](http://www.panasonic.com.au)

PRO-031-F01 Issue: 2.0

09.12.2021



# Panasonic Warranty (New Zealand)

## **Built In Kitchen Appliance 24 Month from Date of Purchase Home Appliance 24 Month Warranty from Date of Purchase**

1. Subject to the conditions of this warranty Panasonic or its Authorised Service Centre will perform necessary service on the product without charge for parts or labour, if in the opinion of Panasonic, the product is found to be faulty within the warranty period. For Line Communications products (i.e. Cordless Phones, etc) the genuine battery(s) has a 3 month warranty.
2. This warranty only applies to Panasonic products purchased in New Zealand and sold by Panasonic New Zealand or its authorised Distributors or Dealers and only where the products are used and serviced within New Zealand or its territories. Warranty cover only applies to service carried out by a Panasonic Authorised Service Centre and only if valid proof of purchase is presented when warranty service is requested.
3. This warranty only applies if the product has been installed and used in accordance with the manufacture's recommendations (as noted in the operating instructions) under normal use and reasonable care (in the opinion of Panasonic). The warranty covers normal domestic use only (also Clip & Trim Professional use) and does not cover damage, malfunction or failure resulting from use of incorrect voltages, incorrect installation, accident, misuse, neglect, build-up of dirt or dust, abuse, maladjustment of customer controls, mains supply problems, thunderstorm activity, infestation by insects or vermin, tampering or repair by unauthorised persons (including unauthorised alterations), exposure to abnormally corrosive conditions or any foreign object or matter having entered the product.
4. This warranty does not cover the following items unless the fault or defect existed at the time of purchase:
  - (a) Cabinet Parts
  - (b) Microwave Oven cook plates
  - (c) User replaceable Batteries from wear and tear in normal use
  - (d) Kneader mounting shaft unit and Heads, Cutters, Foils, Blades and other accessories
  - (e) Noise or vibration that is considered normal
  - (f) Correcting the installation (e.g. removal of transit bolts, levelling and locking feet)
  - (g) Damage caused by water pressure exceeding 1MPa
  - (h) Water on floor due to incorrect loading, excessive suds, foreign matter on door seals
  - (i) Blocked pumps and removal filters, removal of foreign objects from the machine (e.g. bra wires, bread tags, nails, screws, coins, grit etc.)
  - (j) Replaceable lint filters
  - (k) Damage to surfaces caused by liquid or solid spillages, impact or lack of maintenance & cleaning products other than that recommended in the operating instructions
  - (l) Consumables (light bulbs, filters)

5. To claim warranty service, when required, you should:
  - Telephone Panasonic's Customer Care Centre on 09 272 0178 or visit our website referred to below and use the Service Centre Locator for the name/ address of the nearest Authorised Service Centre.
  - Send or take the product to a Panasonic Authorised Service Centre together with your proof of purchase receipt as a proof of purchase date. Please note that freight and insurance to and / or from your nearest Authorised Service Centre must be arranged by you.
6. The warranties hereby conferred do not extend to, and exclude, any costs associated with the installation, de-installation or re-installation of a product, including costs related to the mounting , de-mounting or remounting of any screen, (and any other ancillary activities), delivery, handling, freighting, transportation, or insurance of the product or any part thereof or replacement of and do not extend to , and exclude, any damage or loss occurring by any reason of, during, associated with, or related to such installation, de-installation, re-installation or transit.

Panasonic Authorised Service Centres are located in major metropolitan areas and most regional centres of New Zealand, however, coverage will vary dependant on product. For advice on exact Authorised Service Centre locations for your product, please telephone our customer Care Centre on 09 272 0178 or visit our website and use the Service Centre locator.

Unless otherwise specified to the consumer the benefits conferred by this express warranty are additional to all other conditions, warranties, guarantees, rights and remedies expressed or implied by the Consumer Guarantees Act of New Zealand and all other obligations and liabilities on the part of the manufacturer or supplier and nothing contained herein shall restrict or modify such rights, remedies, obligations and liabilities.

**THIS WARRANTY CARD AND THE PURCHASE DOCKET  
(OR SIMILAR PROOF OF PURCHASE)  
SHOULD BE RETAINED BY THE CUSTOMER AT ALL TIMES**

If you require assistance regarding warranty conditions or any other enquiries, please visit the **Panasonic New Zealand** website [www.panasonic.co.nz](http://www.panasonic.co.nz) or contact by phone on **09 272 0178**

*If phoning in, please ensure you have your operating instructions available.*

## **Panasonic New Zealand Customer Care Centre**

Phone: 09 272 0178

Fax: 09 272 0129

Email: [customerservice@nz.panasonic.com](mailto:customerservice@nz.panasonic.com)

Website: [www.panasonic.co.nz/support](http://www.panasonic.co.nz/support)



**Panasonic Corporation**  
Website: <https://www.panasonic.com>

© Panasonic Corporation 2022

PN:  
F0622-20125  
Printed in China