

Panasonic®

Operating / Installation Instructions

Built-in Electric Oven

Model No. HL-PF685S
HL-PF685B



HL-PF685S

FOR DOMESTIC USE ONLY

IMPORTANT SAFETY INSTRUCTIONS: Before operating this appliance, please read these instructions carefully and keep for future reference.

Thank you for purchasing this Panasonic appliance.

Contents

| | | | |
|---|-------------|--|--------------|
| Operating Instructions | 4-49 | • Plate Warming | 26 |
| Safety Instructions | 4-7 | • Child Lock | 27 |
| Disposal of Waste Products | 8 | • Oven Lighting | 27 |
| Energy Saving Tips | 8 | • Kitchen Timer | 27 |
| Before Using Your Oven | 9 | • General Settings | 28 |
| Features and Functions | 10-11 | • Language | 28 |
| Oven Equipment and Accessories | 12 | • Time | 28 |
| General Controls | 13 | • Display | 28 |
| Using the Appliance | 14-28 | • Sound | 28 |
| • Setting the Clock | 14 | • Other Settings | 28 |
| • Cooking Modes | 15 | Cooking Charts | 29-40 |
| • Auto Mode | 16-17 | • Upper / Lower Heater | 30-31 |
| • Manual Mode | 18-19 | • Full Grill / Half Grill | 32-33 |
| • Operation Modes | 20 | • Fan Grill | 34 |
| • Delayed start | 21 | • Convection and Lower Heater | 35 |
| • Multi-stage Cooking | 22 | • Convection | 36-37 |
| • Starting the Cooking Process | 23 | • Eco Cooking | 38 |
| • End of Cooking | 23 | • Lower Heater and Fan | 38-39 |
| • Saving to Memory | 24 | • Auto Roast Mode | 40 |
| • Extras and Additional Functions | 25-27 | Maintenance and Cleaning | 41-48 |
| • Pyro clean | 25 | Troubleshooting | 49 |
| • Warming | 25 | Installation Instructions | 50-53 |
| • Defrost | 25 | Specifications | 54 |
| • Fast Preheat | 26 | | |

Operating Instructions

Safety Instructions

- This appliance can be used by children aged from 8 years and above and persons with reduced physical, sensory or mental capabilities or lack of experience and knowledge if they have been given supervision or instruction concerning use of the appliance in a safe way and understand the hazards involved. Children shall not play with the appliance. Cleaning and user maintenance shall not be made by children without supervision.
- **WARNING:** The appliance and its accessible parts become hot during use. Care should be taken to avoid touching heating elements. Children less than 8 years of age shall be kept away unless continuously supervised.
- **WARNING:** Danger of fire: do not store items on the cooking surfaces.
- Do not use harsh abrasive cleaners or sharp metal scrapers to clean the oven door glass since they can scratch the surface, which may result in shattering of the glass.
- Do not use steam cleaners or high-pressure cleaners to clean the cooking appliance, as this may result in an electric shock.
- **WARNING:** Before replacing the light bulb, make sure the appliance has been disconnected from the mains power, in order to prevent an electric shock.
- The appliance is not intended to be controlled with external timers or special control systems.

Safety Instructions

- The appliance is intended for household use. Do not use it for any other purpose, such as room heating, the drying of paper or fabrics, etc. as this may lead to injury or fire hazard.
- Tampering with the appliance or non-professional repair thereof may result in risk of severe injury or damage to the product.
- If the power cord is damaged, it should be replaced by the manufacturer or an authorised service technician, in order to avoid hazard.
- Do not line the oven walls with aluminium foil and do not place baking trays or other cookware on the base of the oven. Aluminium foil could prevent air circulation in the oven, hinder the cooking process, and damage the enamel coating.
- The appliance becomes very hot during use. Suitable heat-proof gloves should be worn.
- Oven door hinges may be damaged when under excessive load. Do not place heavy pans on open oven door and do not lean against open oven door when cleaning the oven cavity. Never stand on the open oven door and do not let children sit on it.
- Make sure the vents are never covered or obstructed in any way.
- Spray canisters, aerosols and other inflammable substances can ignite when heated. Do not store or use these items near the oven.
- Do not use sealed tins or containers in the appliance.
- Take care when cooking with fats and oils.

Safety Instructions

- Do not attempt to tamper with or make any adjustments or repairs to the door, control panel housing, safety interlock switches or any other part of the oven. Repairs should only be carried out by service technicians authorised by the appliance manufacturer.
- All cooking operations must take place with the door closed.
- The appliance becomes very hot during use. Suitable heat-proof gloves should always be worn.
- Take care when cooking foods containing high alcohol content. Alcoholic vapours may ignite.
- The socket the oven is plugged into must be connected to the household main circuit board.
- The manufacturer cannot be held liable for damage to persons or items caused by failure to observe the above instructions, by interference with any part of the appliance or by the use of non-original spare parts.

Safety Instructions

Pyro cleaning

- Before activating the automatic cleaning process, remove any cookware that is not part of the oven equipment.
- During the automatic cleaning process, the oven gets very hot from the outside. Risk of burns! Keep children away from the oven.
- Before activating the automatic cleaning process, carefully read and follow the instructions in the chapter Maintenance and Cleaning (see page 41).
- Do not place anything directly onto the base of the oven.
- The telescopic guides cannot be cleaned using Pyro clean.
- Pieces of food and grease may ignite during the automatic pyrolytic cleaning process.
- Danger of fire! Remove larger food residue and other impurities from the oven before using the automatic cleaning process.
- Make sure no impurities enter the door lock latch. This could prevent automatic locking of oven door during the automatic cleaning procedure.
- In case of a power outage during the pyrolytic cleaning process, the program is terminated after two minutes and the oven door remains locked. The door will be unlocked approximately 30 minutes after power supply is restored, regardless of whether the appliance has cooled down.
- When using the pyrolytic cleaning function the surfaces may get hotter than usual and children should be kept away.

Disposal of Waste Products



Information on Disposal
for Users of Waste
Electrical & Electronic
Equipment (private
households)

This symbol on the products and/or accompanying documents means that used electrical and electronic products should not be mixed with general household waste.

For proper treatment, recovery and recycling, please take these products to designated collection points, where they will be accepted on a free of charge basis.

Alternatively, in some countries you may be able to return your products to your local retailer upon the purchase of an equivalent new product.

Disposing of this product correctly will help to save valuable resources and prevent any potential negative effects on human health and the environment which could otherwise arise from inappropriate waste handling.

Please contact your local authority for further details of your nearest designated collection point.

Penalties may be applicable for incorrect disposal of this waste, in accordance with national legislation.

Information on Disposal in other Countries outside the European Union

This symbol is only valid in the European Union.

If you wish to discard this product, please contact your local authorities or dealer and ask for the correct method of disposal.

Energy Saving Tips

- Certain foods do not need a preheated oven. Do not preheat the oven unless necessary or stated in the recipe.
- Do not use full grill if half grill will be sufficient.
- Where possible, cook multiple items at once. This will lower the amount of time that the oven is in use.
- Plan ahead. If you will be cooking food that will keep (puddings, cakes, pastries etc.), do so whilst the oven is still hot from cooking a meal as you will only have to heat up the oven once. This will also save time later on.
- Remove any accessories from the oven that are not required for cooking.
- Avoid opening the door during cooking.
- Do not use the cavity lighting unless necessary.

Before Using Your Oven

This manual constitutes an integral part of the appliance. It should be kept intact and at hand for the appliance's entire life cycle. It is important to carefully read this manual and all of the instructions contained herein before using the appliance.

Examine your oven

Please make sure the appliance was supplied to you undamaged. Remove all packaging and examine the oven for any damage such as dents, broken door latches or cracks in the door. If you find any damage, notify your dealer immediately. Do not install a damaged oven.



WARNING

Remove all internal and external packaging. Please ensure all internal packaging is removed before switching the oven on.

- Before using the oven for the first time, run Convection at 250 °C for 5 minutes. A specific odour of a 'new appliance' will be present. Make sure the room is ventilated.
- After the oven has cooled down, clean the inside and all accessories with warm water and a conventional detergent. Do not use abrasive cleaning aids.

Rating plate

The Rating Plate indicating the basic information of the appliance is attached to the inside of the oven and is visible when you open the door (see page 10). Do not remove.

Features and Functions

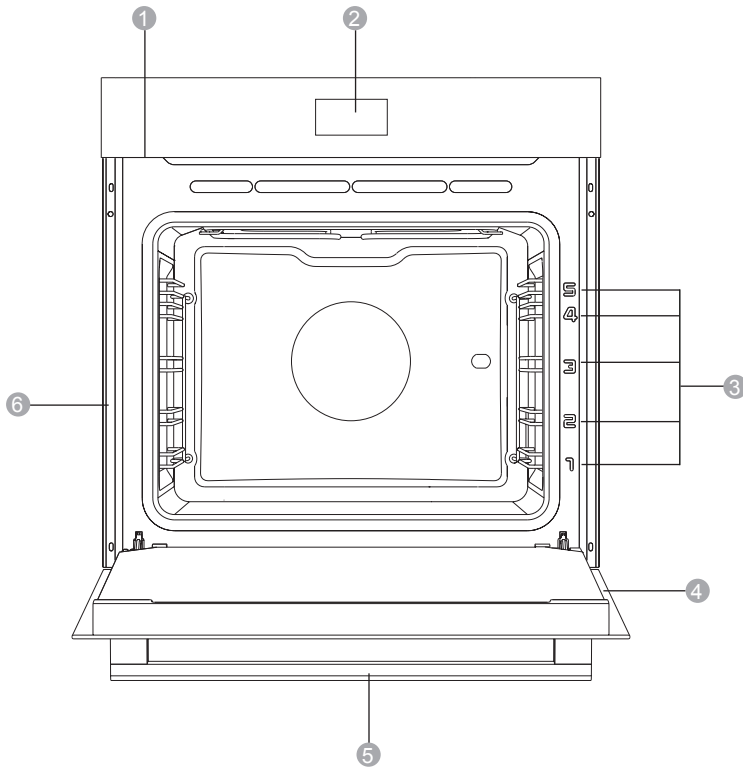

1. Door Lock Latch
2. Control Panel
3. Guides / Shelf Positions (1-5)
4. Oven Door
5. Door Handle
6. Rating Plate

Features and Functions

Wire guides

The wire guides allow cooking of the food in five shelf positions (please note that the shelf positions are counted from the bottom up).

Shelf positions 4 and 5 are intended for grilling.

Telescopic guides

Fully extendible telescopic guides are fitted for the 2nd and 3rd shelf positions.

Oven door switch

The switch deactivates oven heating and the fan when the oven door is opened during the cooking process. When the door is closed, the heaters turn back on.

Cooling fan

The appliance is fitted with a cooling fan that cools the housing and the appliance control panel.

Extended operation of the cooling fan

After the oven is switched off, the cooling fan continues to operate for a short while in order to cool the oven. Extended cooling fan operation depends on the temperature in the centre of the oven.

Soft door opening

Oven door is fitted with a system that softens the door opening force, starting at the 75° angle.

Soft door closing

Oven door is fitted with a system that softens the door closing force, starting at the 75° angle. It allows simple, quiet, and smooth closing of the door. A gentle push, to a 15° angle relative to the closed door position is enough for the door to close automatically and softly.



WARNING

If the force applied to close the door is too strong, the effect of the system is reduced or the system will be bypassed for safety.

Oven Equipment and Accessories



The **Wire Shelf** is used for grilling or as a shelf for cookware, baking tray or baking dish.

💡 There is a safety latch on the wire shelf. Therefore, lift the wire shelf slightly at the front when removing it from the oven.

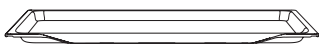

The **Shallow Baking Tray** is used for baking cakes, cookies and small pastry items.

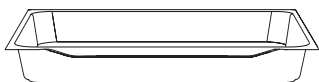

The **Deep Baking Tray** is used for roasting meat and baking pastry. It can also be used as a drip tray.

💡 Never place the deep baking tray in the 1st shelf position during the cooking process.

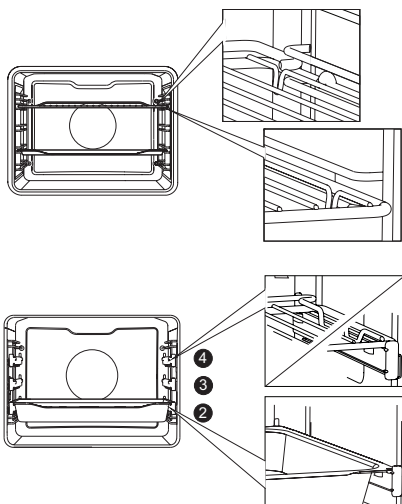

The wire shelf or the tray should always be inserted into the groove between the two wire guides.

To use the telescopic extendable guides, first pull out the left and right adjacent guides all the way, place the wire shelf or baking tray onto them, then push them back in all the way.

💡 Close the oven door when the telescopic guides are retracted all the way into the oven.



WARNING

The appliance and some of the accessible parts heat up during cooking. Use oven gloves.

General Controls

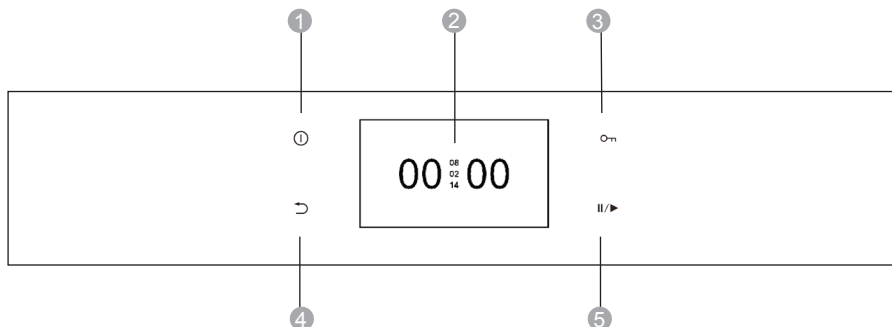

1. **On/Off Key**
2. **Display** - For selection and display of settings.
3. **Child Lock Key** - Touch and hold to turn child lock on.
4. **Back Key** - Touch briefly to **return to previous menu**. Touch and hold to **return to clock mode**.
5. **Start/Stop Key**
6. **Information Panel**

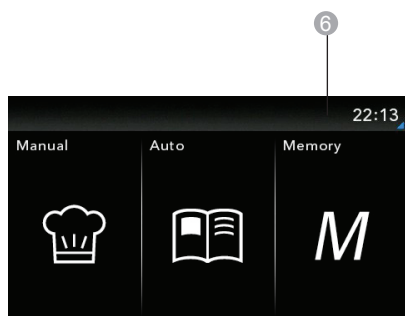

NOTE

The keys will respond more effectively if you touch them with a larger area of your fingertip. Each time you touch a key, there will be a short acoustic signal.

Navigate the menu screen by sliding your finger up and down or left and right. Confirm your selection with a touch.

Using the Appliance

Switching on the appliance for the first time

Setting the clock

After connecting your appliance to the power mains or after an extended power outage, **Clock** settings will appear in the display.

 Navigate the menu by sliding your finger up and down.

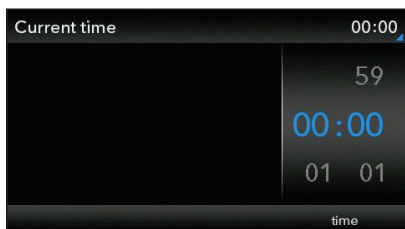

Set the **Clock** by touching the display. Confirm the setting with the Start/Stop key.

 The oven will work if the clock is not set. However, the timer will not function in manual cooking mode. After a few minutes, the appliance will switch to standby mode.



Changing the clock

Clock settings may be changed when no timer function is activated.

Selecting the language

To change the language go to the main menu, select settings and select language. To select the language scroll up and down using your finger, the name of the currently selected language will be enlarged. English is the factory default.



 Press the  key to return to **Previous Menu**.

Using the Appliance

Cooking Modes

There are several cooking modes:



Navigate the menu by sliding your finger left and right.

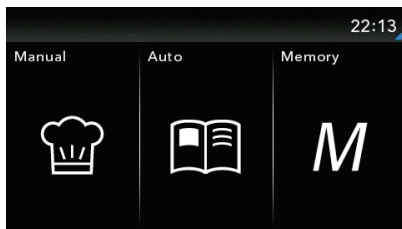

Select the desired mode by tapping the corresponding image. The name of the selected mode will appear in the information panel at the top of the display.

Manual mode

Use this mode to prepare food manually. All settings are selected manually by the user.

Auto mode

In this mode, first select the type of food. This is followed by automatic setting for the quantity (in kg), level of intensity and cooking end time.

The program offers a broad choice of preset recipes.

Memory

This mode is where you will find your stored reheating and cooking programs.

Using the Appliance

Auto Mode

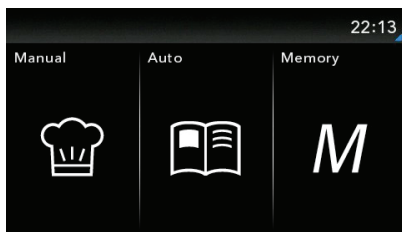

Select Auto mode.



Select the type of food. Choose from the following categories: Meat, seafood, vegetables, soufflés and au gratins, bread, pastry, frozen food, international dishes, quick foods, slow baking, preserve. Select the desired auto mode.

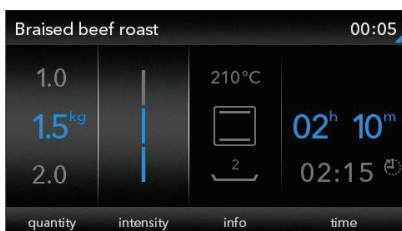

Values will be displayed:

- quantity (weight),
- intensity (doneness level),
- info - temperature, cooking mode and shelf position
- cooking time (cooking end time is displayed in grey).

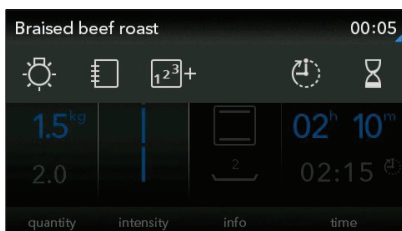

Additional settings

Additional settings can be accessed by tapping the information panel at the top of the display.



- oven lighting



- method and ingredients for the selected recipe



- multi-stage cooking (see page 22)



- cooking end time / delay start (see page 27)



- kitchen timer (see page 27)

Using the Appliance

Preheat

During auto mode it is possible to preheat the oven before cooking.

When a program is selected that requires preheating, a message will appear on the display 'Selected program includes a preheat phase'.

Touch the display and then the Start/Stop key and the message ' The preheat phase is starting' will be displayed and preheating will begin.

The  symbol will appear in the information panel during preheating

When the set temperature is reached, preheating is completed and an acoustic signal will be sounded. The acoustic signal can be stopped by pressing any key or after one minute, it will stop automatically. The following message will be displayed, 'The preheat phase is complete, Please insert the dish'.

When the food is inserted and the door is closed, the cooking process will continue.



NOTE

When the preheat function is set, delayed start function cannot be used.

Using the Appliance

Manual Mode

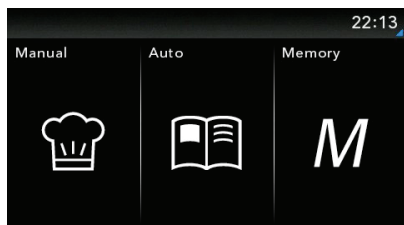

Select Manual mode

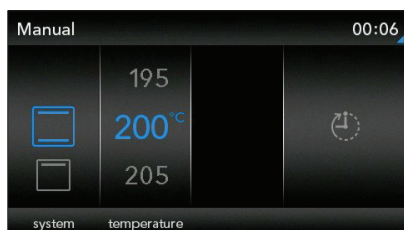

Choose your own manual settings:

Tap the  symbol to select the cooking time. (Cooking end time is displayed in grey during cooking).

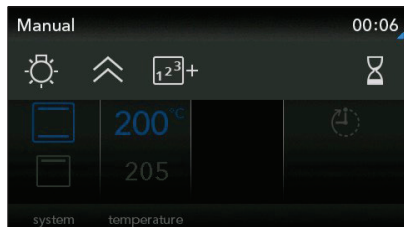

Additional Settings:

Additional settings can be accessed by tapping the information panel at the top of the display.



- oven lighting



- preheating



- multi-stage cooking (see page 22)



- kitchen timer (see page 27)



If you select duration, extra settings will be available in the information panel.

Touch the Start/Stop key.

All selected settings are indicated in the display.



NOTE

Rising oven temperature and elapsed cooking time will be displayed.

Using the Appliance

Preheat

During manual mode it is possible to preheat the oven before cooking.

This option can be found in the information panel menu at the top of the display.

After the temperature is selected, touch the Start/Stop key and the message 'The preheat phase is starting' will be displayed and preheating will begin.

The  symbol will appear in the information panel during preheating

When the set temperature is reached, preheating is completed and an acoustic signal will be sounded. The acoustic signal can be stopped by pressing any key or after one minute, it will stop automatically. The following message will be displayed, 'The preheat phase is complete, Please insert the dish'.

When the food is inserted and the door is closed, the cooking process will continue.













NOTE

When the preheat function is set, delayed start function cannot be used.

Using the Appliance

Operation modes

| OPERATION | DESCRIPTION | PRESET TEMP (°C) |
|---|---|------------------|
|  | UPPER / LOWER HEATER The heaters on the upper and lower side of the oven radiate uniformly and evenly into the oven interior. Pastries, cakes and meat can be cooked on one shelf position. | 200 |
|  | UPPER HEATER Only the upper cavity heater will radiate heat. Use this heater to brown the upper side of the food. | 150 |
|  | LOWER HEATER The heat is radiated by the heater installed in the bottom of the oven. Select this operation mode when you wish to bake / cook the bottom side of the food more thoroughly (e.g. for moist pastry with fruit filling). | 160 |
|  | HALF GRILL The inner heater is activated. This mode is appropriate for grilling smaller quantities of toasted sandwiches or bread. | 240 |
|  | FULL GRILL The inner and the outer heaters are activated simultaneously. This operation mode is appropriate for cooking smaller pieces of meat, such as steaks, chops and sausages. | 240 |
|  | FAN GRILL The upper heater and the fan are activated simultaneously. It is appropriate for grilling and browning poultry pieces, ribs or gratins on one shelf position. | 170 |
|  | CONVECTION AND LOWER HEATER The back heater, the fan and the lower heater operate simultaneously. This is suitable for making pizza, pastries, fruit cakes or baked cheesecakes. | 200 |
|  | CONVECTION The back heater and the fan operate simultaneously in order for the hot air to circulate constantly. This mode is appropriate for roasting meat and baking on several shelves simultaneously. Cooking temperature should be set lower than conventional operation. | 180 |
|  | ECO COOKING In this mode, power consumption during the cooking process is optimised. After approx. 12 mins, temperature will automatically be lowered by 50°C. This will be maintained as long as the door remains closed. It is useful for cooking small amounts of food on one shelf. The actual temperature is not displayed. Opening the door after approx. 30 minutes of Eco mode will revert the temperature to the original setting. | 180 |
|  | LOWER HEATER AND FAN The lower heater and the fan operate simultaneously. Used for baking sweet bread dough and preserving fruit and vegetables. Use the 1st shelf position from the bottom and shallow tray. | 180 |
|  | AUTO ROAST MODE In Auto Roast mode, the upper heater will operate in combination with the grill heater and the back heater. It is used for roasting all types of meat. | 180 |

Using the Appliance

Delayed Start

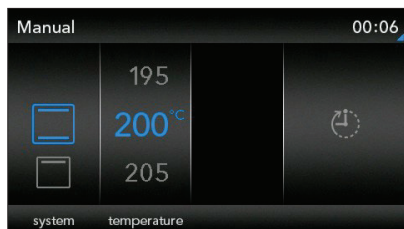

Setting the delayed start

It is possible to specify the duration of the cooking process (cooking time) and the time when you wish the cooking process to stop (end time). Make sure the clock is accurately set to current time.

Example:

Current time: 12:00

Cooking time: 2 hours

End of cooking: 18:00

First, set the cooking time (cooking duration), e.g. 2 hours. Then, set the **Cooking End Time**  (found in the information panel) and set the time (18:00). Press Start/Stop key to start the cooking process. The timer will wait for the start of the cooking process. The following note will appear in the display: "The program has been delayed. It starts at 16:00."

The delayed start and kitchen timer functions can be cancelled by setting the time to '0'.



NOTE

After the set time expires, the oven will automatically stop operating (end of cooking). An acoustic signal will be heard which you may turn off by pressing any key. After one minute, the acoustic signal will be switched off automatically.

After a few minutes, the appliance will switch to standby mode. The time of day will appear.



NOTE

Delayed start cannot be used during any Auto mode when preheating is necessary.

Using the Appliance

Multi-Stage Cooking

This mode allows you to combine three different settings successively in a single cooking process.

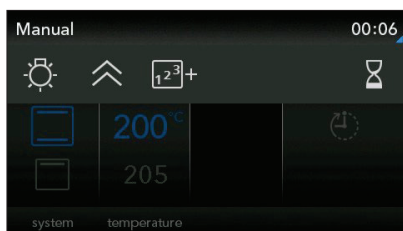

To select Multi-stage cooking, press the **1 2 3 +** found in the information panel menu.



Touch the corresponding part of the display to select a 2nd and 3rd phase. To change settings, touch the desired stage and select the required setting. Touch the tick in the information panel to confirm.

To delete a stage, select the phase to be removed and touch the cross in the information panel.

Once you have set the stages, Touch Start/Stop key to turn on the oven. The oven starts operating immediately, with the settings defined in Stage 1. (Selected stage will be highlighted in blue.)

After the set cooking time elapses, Stage 2 and then Stage 3 are activated.



NOTE

During operation, changes can be made to any stages that have not started.

Using the Appliance

Starting the Cooking Process

Start the cooking process by touching the Start/Stop key.

Some settings can be changed during operation by touching the display unit.

Touch the Start/Stop key to end the cooking process. The following warning and menu will appear: "The program has been paused. Would you like to stop it?"



End of Cooking



After the cooking process, a menu will appear.



End

Select the symbol to end the cooking process. The display will revert to Main Menu.



Add to memory – save

This will allow you to save the selected settings into the oven memory and use them again at a later time. (see page 24)



Extend the cooking time

It is possible to extend the cooking time.

Using the Appliance

Saving to Memory

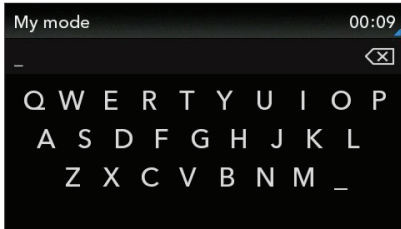

At the end of cooking it is possible to save your settings for future use. Select the **M+** symbol and specify a name. If required, delete a character using the backspace key just below the time in the display.

Touch the Start/Stop key to save the settings.

 Your saved reheating and cooking tasks can be retrieved at any time by selecting Memory from the main menu. (See page 15)

Using the Appliance

Extras and Additional Functions

 Navigate the menu by sliding your finger left and right.

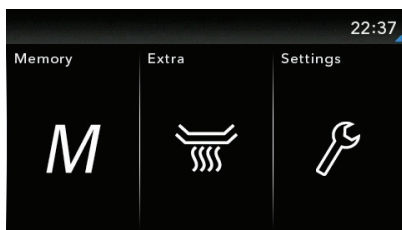

Select the **Extras** menu by touching it. **Extras** menu will appear.

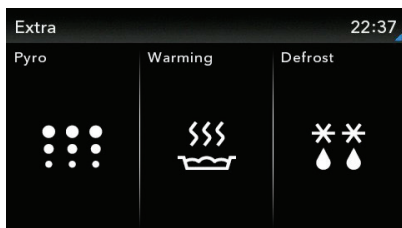

Pyro Clean

This function allows automatic cleaning of the oven cavity/interior. It uses a high temperature, to burn off residues and other impurities. When the automatic cleaning program is completed and the oven has cooled down, just wipe the oven cavity clean with a damp cloth. (See page 43)



Warming

This mode can be used to keep pre-cooked food warm. Select the symbol and set the temperature from 30 - 100 °C. Set the warming time and touch Start/Stop key to start the process.



Defrost

In this mode only the fan will be activated without any heaters. Use this function to slowly defrost frozen foods (cakes, pastries, breads, rolls, and fruits). Select the symbol, set the defrost time and touch Start/Stop key to start the process. During the defrost time, the food items should be turned, stirred and separated.

Using the Appliance



Fast Preheat

Use the preheat function if you wish to heat the oven to the desired temperature as quickly as possible. This mode is not appropriate for cooking. When the oven heats up to the selected temperature, the preheat process is completed and the oven is ready for cooking with the selected cooking mode.



Plate Warming

Use this function to warm your dinnerware (plates, cups etc) before serving food. Select the symbol to set the temperature from 30 - 80 °C. Warming time can also be selected.

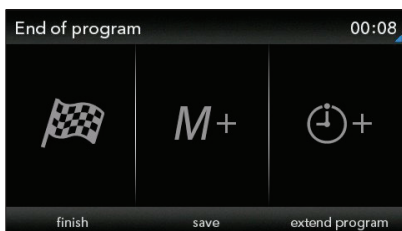

Select Start/Stop to end the cooking process. Main menu will appear in the display.



Child Lock

Activate the child lock by touching and holding the **Lock** key (key symbol). The following message will appear in the display: "The appliance is locked." Touch and hold the key again to deactivate the child lock.

If the child lock is activated when the oven is in operation, then the oven will operate normally; however, it will not be possible to change the settings.

When the child lock is activated, systems (cooking modes) or additional functions cannot be changed. However the cooking process can be stopped completely by touching the On/Off key. Child lock remains active after the oven is switched off. To select another operation, the child lock must first be deactivated.



Oven Lighting

This mode can be selected in the information panel. Oven lighting is switched on automatically when the door is opened or when cooking begins. After the end of the cooking process, the light will remain on for a further minute.



Kitchen Timer

This mode can be selected in the information panel. The kitchen timer can be used independently of the oven operation for a maximum 9 hours 59 mins. When the time expires, an acoustic signal will be heard which can be turned off by touching any key. After one minute, the acoustic signal will be switched off automatically.

Using the Appliance

General Settings

 Navigate the menu by sliding your finger left and right.

Select the Settings menu by touching it.

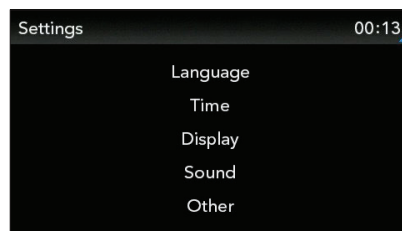
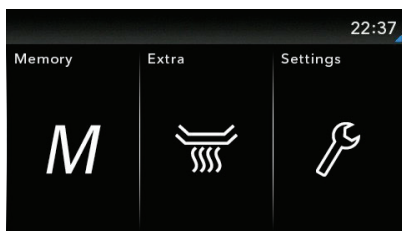

Language

Select the language (See page 14).

Time

Set the current time after the appliance is first switched on or after being disconnected from the power mains for a longer period of time (more than one week). The clock display mode can also be set (*digital or analogue*) See page 14.

Display

In this menu, you can set the following:

Display brightness

Night mode – *set the hours when the display will dim.*

Sound

The volume of the acoustic signal can be set when no timer function is activated (only the time of day is displayed). In this menu, you can choose volume and duration of the alarm. The lowest volume setting is silent.

Other settings

Switch off oven lighting - automatic / manual

Entry into standby mode - automatic / manual

Reset to factory defaults



WARNING

After a power outage or after switching off the appliance, all extra user settings are restored.

Cooking Charts

If your desired food cannot be found in the cooking chart, find information for a similar food type. The information displayed applies to cooking on a single level.

An interval of suggested temperature is indicated. Start with a lower temperature setting and increase it if you find the food is not cooked sufficiently.

Cooking times are rough estimates and may vary subject to certain conditions.

The symbol * means that the oven should be preheated using the selected cooking mode.

Use dark, black silicon-layered or enamel-coated baking trays and trays as they conduct the heat more effectively.

When using baking paper, make sure it is resistant to high temperatures.

When cooking larger joints of meat or pastry, a lot of steam will be generated inside the oven, which in turn may cause condensation on the oven door. This is normal and will not affect the operation of the appliance. After the cooking process, wipe the door and the door glass dry.

Cooking Charts

UPPER / LOWER HEATER

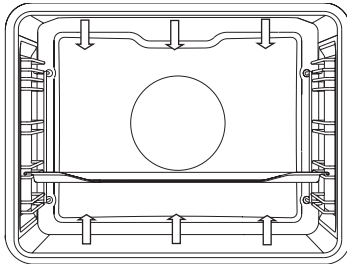

The heaters on the upper and lower side of the oven radiate uniformly and evenly into the oven interior. Pastries, cakes and meat can be cooked on one shelf position.

Roasting meat

It is recommended to use enamel coated, Pyrex ®, earthenware, or cast iron pans or trays.

| Food type | Weight (g) | Shelf position (from the base) | Temperature (°C) | Cooking time (minutes) |
|-----------------------|------------|--------------------------------|------------------|------------------------|
| MEAT | | | | |
| Pork roast | 1500 | 2 | 190-200 | 120-130 |
| Pork shoulder | 1500 | 2 | 190-200 | 120-140 |
| Pork roulade | 1500 | 2 | 190-200 | 120-140 |
| Meat loaf | 1500 | 2 | 200-210 | 60-70 |
| Beef roast | 1500 | 2 | 190-210 | 120-140 |
| Roast beef, well done | 1000 | 2 | 200-210 | 40-60 |
| Veal roulade | 1500 | 2 | 180-200 | 90-120 |
| Lamb roast | 1500 | 2 | 190-200 | 100-120 |
| Rabbit loin | 1500 | 2 | 190-200 | 100-120 |
| Venison shank | 1500 | 2 | 190-200 | 100-120 |
| FISH | | | | |
| Braised fish | 1000 | 2 | 210 | 50-60 |

Cooking Charts

Baking

Only use one level and dark baking trays. On light-coloured baking trays, the browning of the pastry will be less effective. Always place the baking trays on the wire shelf. If you are using the supplied baking tray, remove the wire shelf. Cooking time will be shorter if the oven is preheated.

| Food type | Shelf position (from the base) | Temperature (°C) | Cooking time (minutes) |
|--------------------------------------|-----------------------------------|------------------|---------------------------|
| PASTRY | | | |
| Savoury soufflé | 2 | 190-200 | 30-35 |
| Sweet soufflé | 2 | 190-200 | 30-35 |
| Rolls * | 2 | 200-220 | 30-40 |
| Bread * | 2 | 180-190 | 50-60 |
| White bread * | 3 | 180-190 | 45-55 |
| Buckwheat bread * | 3 | 180-190 | 45-55 |
| Whole grain bread * | 3 | 180-190 | 45-55 |
| Rye bread * | 3 | 180-190 | 45-55 |
| Spelt bread * | 3 | 180-190 | 45-55 |
| Walnut cake | 2 | 180 | 45-55 |
| Sponge cake * | 3 | 160-170 | 25-30 |
| Cheesecake | 2 | 170-180 | 65-75 |
| Cupcakes | 3 | 170-180 | 25-30 |
| Small pastries made with yeast dough | 3 | 200-210 | 25-30 |
| Cabbage pirozhki | 3 | 200-210 | 25-30 |
| Fruitcake | 3 | 140-190 | 90 |
| Meringue | 3 | 120 | 90 |

Tips on baking

Is the cake cooked?

At the end of the cooking time, insert a metal skewer into the highest point of the cake and then withdraw it. If the batter does not stick to the metal skewer, the cake is cooked.

The sponge cake has collapsed after I take it out of the oven

Check the recipe. Check the instructions relating to mixing time. Ensure the oven door is not opened during cooking.

The pastry is too light-coloured

A dark-coloured baking tray cooks dishes faster and browns foods more than lighter coloured pans. Place the tray one shelf position lower, or turn on the lower heater towards the end of the cooking process.

Pastries with a moist filling (e.g. deep filled pie) is not cooked

Reduce the temperature and extend the cooking time.



WARNING

Do not insert the deep baking tray into the 1st shelf position.

Cooking Charts

FULL GRILL / HALF GRILL

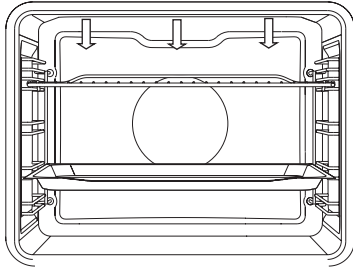

Full Grill

The inner and the outer heaters are activated simultaneously. This operation mode is appropriate for cooking smaller pieces of meat, such as steaks, chops, sausages, etc.

Half Grill

The inner heater is activated. This mode is appropriate for grilling smaller quantities of toasted sandwiches or bread.

Preheat the grill for five minutes.

When cooking with grill, do not leave unattended.

Cooking with the grill heater is suitable for crispy and low-fat cooking of sausages, small cuts of meat and fish (steaks, escalopes, salmon steaks or fillets etc.) or toasted bread.

When grilling directly on the wire shelf, brush it with oil to prevent the meat from sticking onto it and insert it into the 4th shelf position. Insert the drip tray beneath the wire shelf. Turn the food during cooking.

After grilling, clean the oven, and accessories.

Half Grill

| Food type | Weight (g) | Shelf position (from the base) | Temperature (°C) | Cooking time (minutes) |
|----------------------|---------------|--------------------------------|------------------|------------------------|
| MEAT | | | | |
| Beefsteak, rare | 180 g / piece | 4 | 240 | 18-21 |
| Pork neck fillet | 180 g / piece | 4 | 240 | 18-22 |
| Cutlets/chops | 180 g / piece | 4 | 240 | 20-22 |
| Grill sausages | 100 g / piece | 4 | 240 | 11-14 |
| TOASTED BREAD | | | | |
| Toast | / | 4 | 240 | 3-4 |
| Open sandwiches | / | 4 | 240 | 5-7 |

Cooking Charts

Full Grill

| Food type | Weight (g) | Cooking level (from the base) | Temperature (°C) | Cooking time (minutes) |
|-------------------------------|---------------|-------------------------------|------------------|------------------------|
| MEAT | | | | |
| Beefsteak, rare | 180 g / piece | 4 | 240 | 14-16 |
| Beefsteak, well done | 180 g / piece | 4 | 240 | 18-21 |
| Pork neck fillet | 180 g / piece | 4 | 240 | 19-23 |
| Cutlets/chops | 180 g / piece | 4 | 240 | 20-24 |
| Veal escalope | 180 g / slice | 4 | 240 | 19-22 |
| Grill sausages | 100 g / piece | 4 | 240 | 11-14 |
| FISH | | | | |
| Salmon steaks/fillets | 600 | 3 | 240 | 19-22 |
| TOASTED BREAD | | | | |
| 6 slices of white bread | / | 4 | 240 | 1.5-3 |
| 4 slices of multi grain bread | / | 4 | 240 | 2-3 |
| Open sandwiches | / | 4 | 240 | 3.5-7 |



WARNING

Always keep the oven door closed when using the grill. Grill heater, wire shelf, and other oven accessories get very hot during grilling. Use oven gloves and meat tongs.

Cooking Charts

FAN GRILL

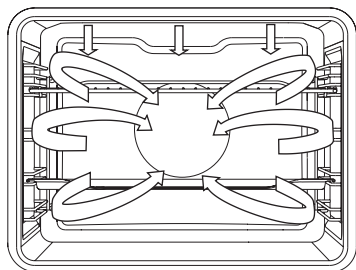

The upper heater and the fan are activated simultaneously. It is appropriate for grilling and browning poultry pieces, ribs or gratins on one shelf position.

| Food type | Weight (g) | Shelf position (from the base) | Temperature | Cooking time (minutes) |
|-----------------|------------|--------------------------------|-------------|----------------------------|
| MEAT | | | | |
| Duck | 2000 | 2 | 150-170 | 80-100 |
| Pork roast | 1500 | 2 | 160-170 | 60-85 |
| Pork shoulder | 1500 | 2 | 150-160 | 120-160 |
| Pork shank | 1000 | 2 | 150-160 | 120-140 |
| Half of chicken | 600 | 2 | 180-190 | 25 (side 1) 20 (side 2) |
| Chicken | 1500 | 2 | 210 | 60-65 |
| FISH | | | | |
| Trout* | 200 | 2 | 170-180 | 45-50 |

Cooking Charts

CONVECTION AND LOWER HEATER

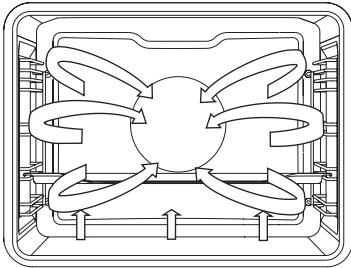

The back heater, the fan and the lower heater operate simultaneously. This is suitable for making pizza, pastries, fruit cakes or baked cheesecakes.

| Food type | Shelf position (from the base) | Temperature (°C) | Cooking time (minutes) |
|-----------------|-----------------------------------|------------------|---------------------------|
| Cheesecake | 2 | 150-160 | 65-80 |
| Pizza | 2 | 200-210 | 15-20 |
| Quiche Lorraine | 2 | 180-200 | 35-40 |
| Apple pie | 2 | 150-160 | 35-40 |
| Apple strudel | 2 | 170-180 | 45-65 |

Cooking Charts

CONVECTION

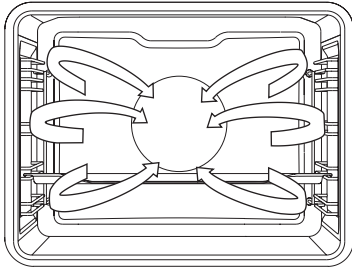

The back heater and the fan operate simultaneously in order for the hot air to circulate constantly. This mode is appropriate for roasting meat and baking on several shelves simultaneously. Cooking temperature should be set lower than conventional operation.

Roasting meat

It is recommended to use enamel coated, Pyrex ®, earthenware or cast iron pan or tray.

Provide enough liquid during the cooking process to prevent the meat from burning. Turn the meat during roasting. Covering the roast can retain moisture.

| Food type | Weight (g) | Shelf position (from the base) | Temperature (°C) | Cooking time (minutes) |
|----------------------------|------------|--------------------------------|------------------|------------------------|
| MEAT | | | | |
| Pork roast, including skin | 1500 | 2 | 170-180 | 140-160 |
| Pork belly | 1500 | 2 | 170-180 | 120-150 |
| Chicken, whole | 1200 | 2 | 180-190 | 60-80 |
| Duck | 1700 | 2 | 160-170 | 120-150 |
| Goose | 4000 | 2 | 150-160 | 180-200 |
| Turkey | 5000 | 2 | 150-170 | 180-220 |
| Chicken breast | 1000 | 2 | 180-190 | 70-85 |
| Stuffed chicken | 1500 | 2 | 170-180 | 100-120 |

Cooking Charts

Baking

Preheating is recommended.

Biscuits and cookies can be baked in shallow baking trays on two shelf positions simultaneously (2nd and 3rd shelf positions). Position the wire shelf in the 3rd shelf position. Place your own baking tray directly on the wire shelf. For the lower level use the shallow baking tray in the 2nd shelf position.

Note that baking time can differ. The biscuits on the upper shelf may be ready sooner than those on the lower one. For even browning, ensure the biscuits are of the same thickness.

| Food type | Shelf position (from the base) | Temperature (°C) | Cooking time (minutes) |
|----------------------------------|-----------------------------------|------------------|---------------------------|
| Cake | 2 | 150-160 | 45-60 |
| Sponge cake | 2 | 150-160 | 25-35 |
| Crumble cake | 2 | 160-170 | 25-35 |
| Fruit cake | 2 | 150-160 | 45-65 |
| Plum cake | 2 | 150-160 | 35-60 |
| Sponge roll | 2 | 160-170 | 15-25 |
| Fruit cake | 2 | 160-170 | 50-70 |
| Challah (braided yeast bun) | 2 | 160-170 | 35-50 |
| Apple strudel | 2 | 170-180 | 40-60 |
| Jelly-filled rolls (Buchtel) | 2 | 170-180 | 30-35 |
| Pizza | 2 | 190-210 | 25-45 |
| Biscuits | 3 | 150-160 | 15-25 |
| Biscuits, pressed | 3 | 150-160 | 15-28 |
| Cookies | 3 | 170-180 | 20-35 |
| Filo pastry | 3 | 170-180 | 20-30 |
| Choux pastry | 3 | 180-190 | 25-45 |
| PASTRY – FROZEN | | | |
| Apple and cottage cheese strudel | 3 | 170-180 | 50-70 |
| Cheesecake | 3 | 160-170 | 65-85 |
| Pizza | 3 | 170-180 | 20-30 |
| Frozen potato products | 3 | 170-180 | 20-35 |
| Croquettes, oven-baked | 3 | 170-180 | 20-35 |



WARNING

Do not insert the deep baking tray into the 1st shelf position.

Cooking Charts

ECO COOKING

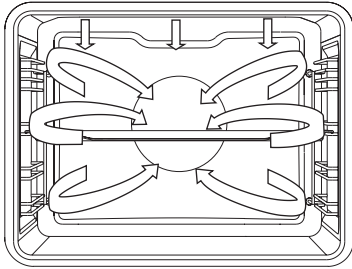

3

The back heater and the fan will operate. The fan installed in the back wall of the oven cavity makes sure the hot air constantly circulates.



WARNING

Do not insert the deep baking tray into the 1st shelf position.

LOWER HEATER AND FAN

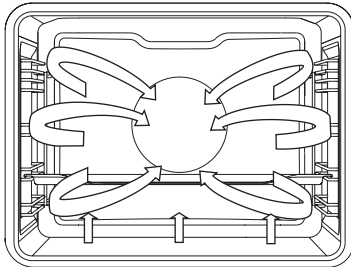

2

The lower heater and the fan operate simultaneously. Used for baking sweet bread dough and preserving fruit and vegetables. Use the 1st shelf position from the bottom and shallow tray.

| Food type | Shelf position (from the base) | Temperature (°C) | Cooking time (minutes) |
|-------------------|--------------------------------|------------------|------------------------|
| FRUIT | | | |
| Strawberries | 2 | 180 | 20-30 |
| Stone fruits | 2 | 180 | 25-40 |
| Fruit sauce | 2 | 180 | 25-40 |
| VEGETABLES | | | |
| Pickled gherkins | 2 | 180 | 25-40 |
| Beans/carrots | 2 | 180 | 25-40 |

Cooking Charts

Preserving

Prepare the food to be preserved and jars as usual. Use jars with a rubber sealing ring and a glass cover. Do not use jars with threaded or metal caps or metal tins. Make sure the jars are of equal size, filled with the same contents, and tightly sealed.

Pour 1 litre of hot water into the deep tray (approx. 70 °C) and place 6 1-litre jars into the tray. Place the tray into the oven in the 2nd shelf position.

During preservation, observe the food and cook until bubbles appear in the first jar.

| Food type | Amount (L) | 170 °C – 180 °C until bubbles appear in the first jar | Temperature at the start of simmering – when bubbles appeared | Resting time in the oven (min) |
|-------------------|------------|---|--|--------------------------------------|
| FRUIT | | | | |
| Strawberries | 6×1 L | 40-55 | switch off | 25 |
| Stone fruits | 6×1 L | 40-55 | switch off | 30 |
| Fruit sauce | 6×1 L | 40-55 | switch off | 35 |
| VEGETABLES | | | | |
| Pickled gherkins | 6×1 L | 40-55 | switch off | 30 |
| Beans, carrots | 6×1 L | 40-55 | 120 °C, 60 min | 30 |

Cooking Charts

AUTO ROAST MODE

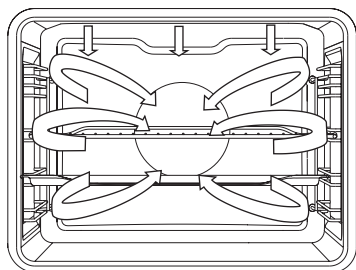

In the Auto Roast mode, the upper heater will operate in combination with the grill heater and the back heater. It is used for roasting all types of meat.

When grilling directly on the wire shelf, brush it with oil to prevent the meat from sticking onto it and insert it into the 3rd shelf position. Insert the deep baking tray into the 2nd shelf position. When roasting meat in a baking tray, insert it into the 2nd shelf position.

| Food type | Weight (kg) | Shelf position (from the base) | Temperature | Cooking time (minutes) |
|-----------------|-------------|--------------------------------|-------------|------------------------|
| MEAT | | | | |
| Beef tenderloin | 1000 | 3 | 190-210 | 45-55 |
| Chicken, whole | 1500 | 3 | 170-190 | 60-70 |
| Chicken, whole | 2000 | 3 | 170-190 | 90-110 |
| Turkey | 4000 | 3 | 160-180 | 150-180 |
| Pork roast | 1700 | 3 | 150-170 | 100-120 |
| Meat loaf | 1000 | 3 | 160-180 | 70-80 |
| Veal | 1000 | 3 | 170-190 | 100-120 |
| Lamb | 1000 | 3 | 170-190 | 50-60 |
| Venison | 1000 | 3 | 170-190 | 55-65 |
| Fish | 1000 | 3 | 160-180 | 35-55 |

Maintenance and Cleaning

Do not use a steam cleaner or a high-pressure steam cleaner to clean the appliance.

External surfaces

Clean the surfaces with non-abrasive detergents and a soft cloth. Apply the detergent on the cloth and wipe off the dirt; then, rinse with water. Do not use abrasive cleaners, sharp objects or steel wool, as these will scratch the appliance.

Door handle

Door handle should be cleaned with non-abrasive detergent. Apply the detergent on a wet cloth and clean the surface; then, rinse the surface with water. Do not apply the cleaner directly on the aluminium surface. Do not use abrasive cleaners or abrasive sponges.

Stainless steel front panels

Clean the surface with a mild cleaner and a soft sponge that will not scratch the material. Do not use abrasive or solvent-based cleaners.



WARNING

Before performing cleaning and maintenance tasks, use isolating switch to disconnect the power supply and wait for the appliance to cool down.

Children should not clean the appliance or perform maintenance tasks.

The surfaces should never come into contact with oven cleaning sprays, as these may cause permanent damage.

Maintenance and Cleaning

Dealing with stubborn stains:

The oven should be cooled down before each cleaning process.

- Clean the oven and accessories after each use to prevent any food residues from being burnt onto the oven.
- The easiest way to remove grease is by regularly cleaning with a mild detergent.
- In case of stubborn stains, use conventional oven cleaners. Then, rinse the oven thoroughly with clean water to remove all residues.
- Never use abrasive cleaners such as steel wool, abrasive sponges, stain removers, etc.
- Lacquer-coated, stainless steel, zinc-coated and aluminium parts, should never come into contact with oven cleaning sprays, as these may cause damage and discolouration. This applies for the thermostat sensor and the heaters in the upper part of the oven.
- Observe the instructions provided by cleaning agent manufacturers.

Practical tips

- Take care when cooking larger fatty pieces of meat or poultry, cover with aluminum foil, to prevent the grease from splattering on the oven interior walls.
- When grilling meat on the wire shelf, place a drip tray underneath.

Accessories

Wash the accessories (baking trays, wire shelf, etc.) with hot water and mild detergent.

Maintenance and Cleaning

Pyro clean - automatic oven cleaning

For normal oven use, it is advised to run the pyro cleaning program once per month. Wipe the oven with a damp cloth. Food and fat residues may ignite during the process.

Before activating pyro cleaning program, remove all guides and accessories.



WARNING

If the oven is installed underneath a hob, make sure that the burners or electric plates remain off during the automatic cleaning cycle. During the pyro cleaning program, hot air may be exhausted from the vent above the door.

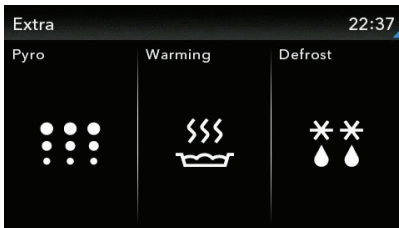

Select Pyro in the Extras menu.

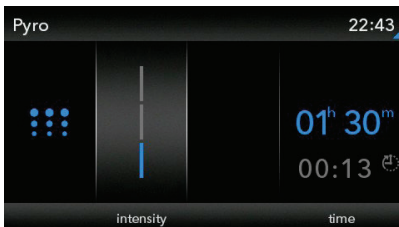

Choose the desired cleaning intensity.

Level 1: *approx. 90 min*

Level 2: *approx. 120 min*

Level 3: *approx. 150 min*

Maintenance and Cleaning

When the temperature reaches 250 °C the oven door will lock automatically.

Do not open the oven door while the automatic cleaning program is in progress. The program may be terminated.

Unpleasant odours may be emitted from the oven during the cleaning process.

After the cleaning process: "The door is locked. The oven is cooling down." appears in the display.

When the oven has cooled down, wipe it with a damp cloth. Wipe the oven door and the adjacent surfaces. Do not rub the door seal.



WARNING

Whilst using the pyro cleaning program the surfaces may get hotter than usual and children should be kept away.

Cleaning the accessories in the oven

The pyro clean program can also be used to occasionally clean the shallow baking tray and deep baking tray. After use, clean them with hot water and detergent, then wipe them with a cloth and place them into the 2nd or 3rd shelf position of the wire guide. Do not use the telescopic guides during pyro cleaning program.

Maintenance and Cleaning

Removing the guides

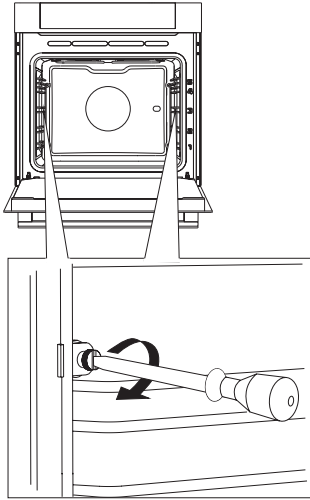

1 Undo the screw.

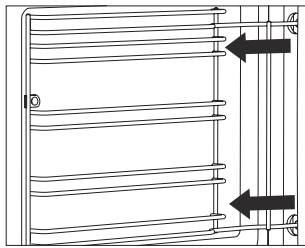

2 Remove the guides from the holes in the back wall.



NOTE

After cleaning, replace guides and tighten screws.

Maintenance and Cleaning

Removing and inserting the oven door

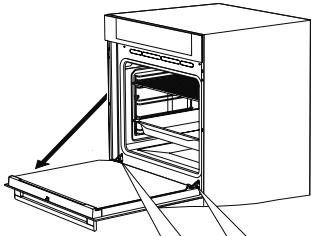

1 First, fully open the door.

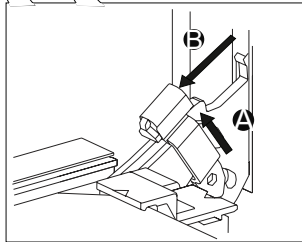

2 Slightly lift the hinge retainers and pull the door towards you.

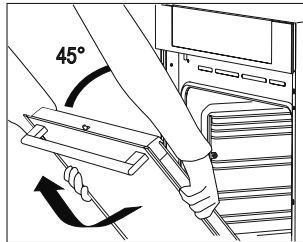

3 Slowly close the door to a 45° angle (relative to the position of the fully closed door); then, lift the door and pull it out.



To replace the door, follow the reverse order. If the door does not open or close properly, make sure the notches on the hinges are aligned with the hinge beds.

Maintenance and Cleaning

Removing and inserting the oven door glass

Oven door glass pane can be cleaned from the inside, but it has to be removed first. Remove the oven door (see page 46).

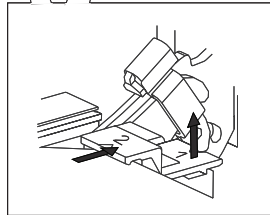
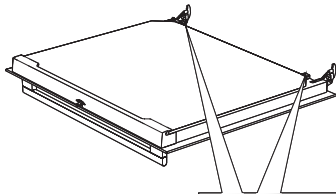

1 Slightly lift the supports on the left and right side of the door (1 on the diagram) and pull them away from the glass pane (2 on the diagram).

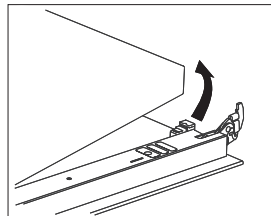

2 Hold the door glass pane by the lower edge. Slightly lift it so that it is no longer attached to the support then remove it.

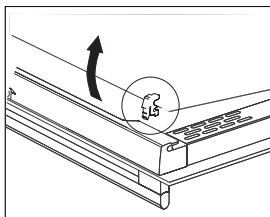

3 To remove the third glass pane, lift and remove it. Also remove the rubber seals on the glass pane.



NOTE

To replace the glass pane, observe the reverse order.

Maintenance and Cleaning

Replacing the bulb

The bulb is a consumable and therefore not covered by warranty. Before changing the bulb, remove the trays, the wire shelf, and the guides.



WARNING

Before replacing the light bulb, make sure the appliance has been disconnected from the mains power via the isolating switch, in order to prevent an electric shock.

(Halogen lamp: G9, 230 V, 25 W)

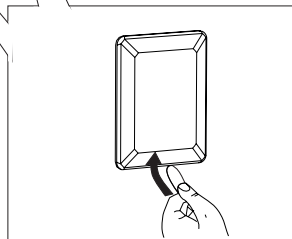
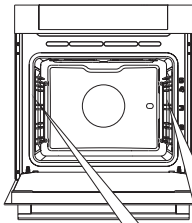

 Unplug the appliance from the power supply and wait for the appliance to cool down.

1 Use a flat screwdriver to release the bulb cover and remove it.

NOTE: Take care not to damage the enamel.

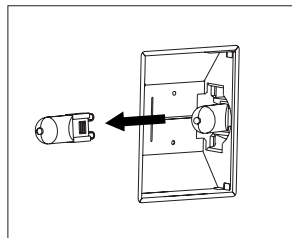

2 Remove the halogen bulb.

Troubleshooting

| Symptom | Possible cause |
|--|--|
| The display does not respond - the display is frozen. | Disconnect the appliance from the main power switch for a few minutes, then reconnect the appliance and switch it on. |
| The main fuse in your home trips often. | Call a service technician. |
| The oven lighting does not work. | The process of changing the light bulb is described on page 48. |
| Error code is displayed: ERRXX ... * XX denotes the number/code of the error. | <ul style="list-style-type: none"> • There is an error in the electronic module operation. Disconnect the appliance from the power mains for a few minutes. Then, reconnect it and set the time of day. • If the error is still indicated, call a service technician. |
| The mechanical door lock has remained in the locked position (either with door open or closed) | <ul style="list-style-type: none"> • The most likely cause for this issue would be a power outage. Refrain from touching the appliance for approx. 1 minute. The issue should resolve itself and the lock should return to it's initial position. • If the issue does not resolve itself, call a service technician. |

If the problems persist despite following the advice above, call an authorised service technician. Repair or any warranty claim resulting from incorrect connection or use of the appliance shall not be covered by the warranty. In this case, the user will cover the cost of repair.

During the warranty period, any repairs may only be performed by service technicians authorised by the appliance manufacturer.

Unauthorised tampering and repairs may cause a risk of electric shock and short circuit; do not attempt this yourself. Consult an authorised service technician.

Installation Instructions

Installation and Connection

Please fully observe the following safety precautions.



IMPORTANT

- Unpack the appliance, remove all packing material, and examine for any damage. If the appliance is damaged DO NOT install and notify your dealer immediately.
- Install the appliance in accordance with the Installation Instructions. Otherwise, the performance of the appliance may be affected.
- After installation perform a test run and explain to the customer how to operate the appliance advising location of isolating switch.
- Correct installation is the responsibility of the installer. Any malfunction or accident resulting from the failure to follow the Installation Instructions is not covered by the warranty.
- The rating plate indicating the basic information of the appliance is attached to the inside of the oven and is visible when you open the door. Do not remove.

Safety Instructions

- When the appliance is installed with another suitable appliance, it must be fitted above a fixed shelf in the housing unit that is able to support the weight of both appliances.
- When built in directly above a warming drawer, an interim shelf between the two appliances is not necessary.
- The appliance must be installed in a position where it can be fully opened and the contents can be clearly viewed. This is to avoid burns and other injuries.

Safety Instructions

- For the appliance to function correctly, it is important that the base of the appliance is level. A spirit level should be used.
- The appliance must only be operated when built-in. This is to ensure that all electrical parts are shielded and live parts are not exposed.
- Ensure power is not supplied to the appliance until after installation work has been carried out.
- The manufacturer will not be held liable for any damages resulting from incorrect or improper installation.

Installing the Appliance



WARNING

Electrical work must be performed by a legally qualified electrician.

Electrical connection

- Before connection, check that the mains voltage corresponds to that indicated on the rating plate fixed to the inside of the appliance. This data must correspond in order to avoid the risk of damage to the appliance.
- This appliance is not fitted with other means for disconnection from the supply mains having a contact separation in all poles that provide full disconnection in under overvoltage category III conditions. Means for disconnection must be incorporated in the fixed wiring in accordance with the wiring rules and regulations.
- Single-phase AC 200-240, 50 Hz electrical system must be used.
- Check the local utilities for electrical codes applied in the area. Failure to wire the appliance according to governing rules may result in a hazardous condition.
- After installation show the customer where the isolating switch for the appliance is located. This must be easily accessible with the installed appliance.

Installation

- Veneer or other finish of the furniture the appliance is being built into should be processed with heat-resistant glue (100°C); otherwise, high temperatures may cause them to deform.
- There must be no rear wall fitted to appliance housing.
- There must be a gap of at least 40 mm between the wall and the back of the unit to enable adequate air circulation.
- Level the piece of furniture the appliance was built into with a spirit level.
- The piece of kitchen furniture the appliance is built into must be secured against movement, e.g. Attached to the adjacent pieces of kitchen furniture.
- Align the appliance flush with the units and screw it in place.
- When attaching the appliance, make sure the screws are not fastened too strongly as this may damage the furniture or the appliance enamel coating.
- The ventilation slots and air intake points must not be covered. To ensure that they remain uncovered also observe the installation instructions of any appliance installed with this oven.



NOTE

- Ensure that the connector lead does not become trapped or bent.
- After installation the connector lead must not be in contact with the back or the base of the appliance.

Dimensions

(measurements: mm)

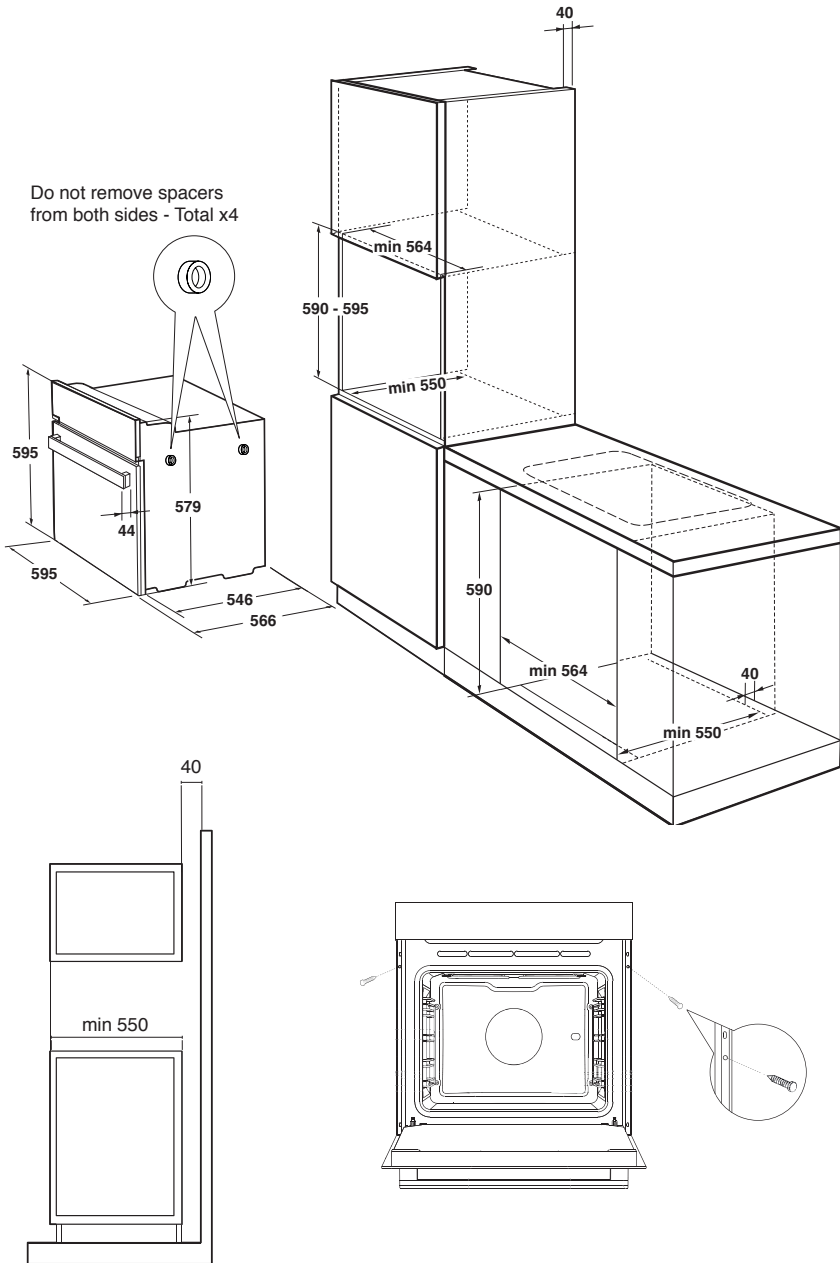

Specifications

| Manufacturer | Panasonic |
|---|------------------------------------|
| Model identification | HL-PF685SEPG HL-PF685BEPG |
| Type of oven | Built-in |
| Mass of the appliance | 38 kg |
| Number of cavities | 1 |
| Heat source per cavity | Electric |
| Volume per cavity | 70 l |
| Energy consumption required to heat a standardised load in a cavity of an electric heated oven during a cycle in conventional mode per cavity | 0.94 kWh /cycle |
| Energy consumption required to heat a standardised load in a cavity of an electric heated oven during a cycle in fan-forced mode per cavity | 0.89 kWh /cycle |
| Energy efficiency index per cavity | 106.0 |
| Power supply | 220-240 V \sim 50/60 Hz |
| Power consumption | 3400 W |
| External dimensions (approx.) | 595 mm (W) 566 mm (D) 595 mm (H) |
| Interior dimensions (approx.) | 481 mm (W) 415.5 mm (D) 352 mm (H) |

This product complies with the requirements of EN 60350-1:2013 (Methods for measuring Performance - Ovens)

Manufactured by: Panasonic Manufacturing U.K. Ltd.

Wyncliffe Road, Pentwyn Industrial Estate, Cardiff, S.Glam. CF23 7XB U.K.

REP. EU: Panasonic Testing Centre

Winsbergring 15, 22525 Hamburg, Germany

Panasonic Manufacturing U.K. Ltd.

<http://www.panasonic.com>

© Panasonic Corporation 2015

E000343X0BP

G0515-00515

Printed in Slovenia