

Operating & Installation Instructions

Fully Automatic Washing Machine
(Household Use)

Model No. **NA-F95G2**
NA-F85G2



Contents

Safety Precautions	2
Part Names	3
Operation Panel	4
Variety of Programs	5
Detergent	6
Washing	7
Washing Options	8
<ul style="list-style-type: none"> • Bedding • Delicate • Cotton Eco • Air Dry (90 min) • Wash / Rinse / Spin 	
Convenient Functions	10
Maintenance	10
Installation	12
Troubleshooting	15
Error Display	16
Specifications	16

Thank you for purchasing this product.

- Read these instructions carefully for optimum performance and safety before use.
- Keep this manual for future reference.



AWW9901D4N01

T1019-11219 (A)(N)

Printed in Thailand

12-2019

Safety Precautions

Read and follow these safety precautions.



WARNING

May cause serious injury or death.

Home hot water heater safety

- Under certain conditions, hydrogen gas may be produced in your hot water heater that has not been used for two weeks or more. Hydrogen gas can be explosive under these circumstances. To prevent the possibility of damage or injury, you should turn on all hot water faucets in your home, and let the water flow out for several minutes before connecting to your washing machine. This will allow any built-up hydrogen gas to escape. Since hydrogen gas is flammable, do not smoke or use an open flame or start appliance during this process.

Never do the following about the power plug and cord

(To prevent fire or electric shock)

- Do not plug in or unplug the power cord with wet hands.
- Do not hold or pull on the cord when removing the plug from the socket.
- Do not use a power cord or plug that is damaged. If the power cord is damaged, it must be replaced by the manufacturer, its service agent or similarly qualified persons in order to avoid a hazard.

Observe the following about the power plug and cord

(To prevent fire or electric shock)

- Use a socket that satisfies the rating requirement solely for this appliance. Do not use a plug adaptor or extension cord.
- Always fully insert the power plug into the socket.
- Wipe the power plug periodically with a dry cloth. (Accumulated dust collects moisture, which may cause insulation failure, resulting in fire.)
- Unplug the power cord before cleaning.

Never disassemble, repair or modify the appliance yourself.

- In case of malfunction or failure, immediately stop use, unplug the power cord, and ask your nearest service centre for repair.

Do not allow children to use on their own.

- This appliance is not intended for use by persons (including children) with reduced physical, sensory or mental capabilities, or lack of experience and knowledge, unless they have been given supervision or instruction concerning use of the appliance by a person responsible for their safety.
- Children should be supervised to ensure that they do not play with the appliance.

Keep away from fire.

Do not put flammable materials or clothes with such things attached in the tub. Keep them away from the appliance.

(To prevent explosion or fire)

- For example: Kerosene, gasoline, benzine/thinner, alcohol, etc.

Do not touch the tub until it completely stops.

(To prevent injury)

- If the tub does not stop within 15 seconds when the lid is opened during spin process, switch off the appliance immediately and call a service person.

Be sure to provide a ground.

(To prevent electric shock if electricity leakage occurs.)

- To establish a ground, ask a service person to do the grounding work.



Part Names



CAUTION

May cause injury or property damage.

For machine-washable items only.

- This appliance is intended to be used in household. This appliance is not intended to be used in applications such as:
 - staff kitchen areas in shops, offices and other working environments;
 - farm houses;
 - by clients in hotels, motels and other residential type environments;
 - bed and breakfast type environments;
 - areas for communal use in blocks of flats or in laundrettes.

Do not wash, rinse, or spin waterproof sheets or clothes.

(To prevent injury, damage to the main unit, walls, floor or laundry, or water leakage if the appliance falls over or oscillates extremely while spinning)

- Raincoats, wet suits, etc.

Observe the following

- **Locate away from direct sunlight or heat. (To prevent malfunction or deformation.)**
- New hose-sets supplied with the appliance are to be used and old hose-sets should not be reused.
- Be careful not to get your fingers caught when opening and closing the lid.
- Do not insert your hands or feet under the main unit. (To prevent injury by rotating parts.)
- Do not climb or put heavy objects on the appliance. (To prevent deformation and breakage resulting in injury)
- If the lid is broken, immediately stop using the appliance. (To prevent deformation and breakage resulting in injury)
- Do not use water hotter than 60 °C.
- Do not make wrong connection for the HOT and COLD water supply faucets.
- Depending on the connected water heater, very hot water may come out. Be careful not to burn yourself.
- Do not add extra water directly into the tub.
- Do not obstruct the openings of the bottom face with carpet, etc.

Turn off the water faucet after operation.

(To prevent water leakage)

- For maximum mass of dry cloth and pressure of tap water, see P.16 .

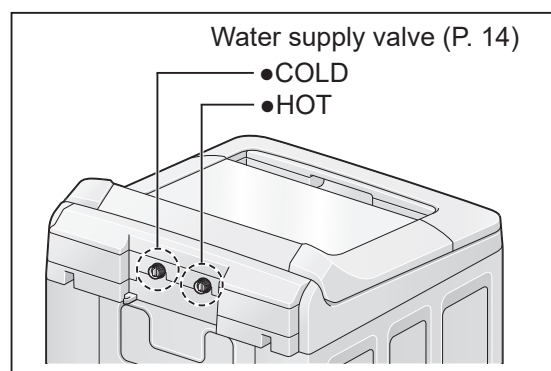
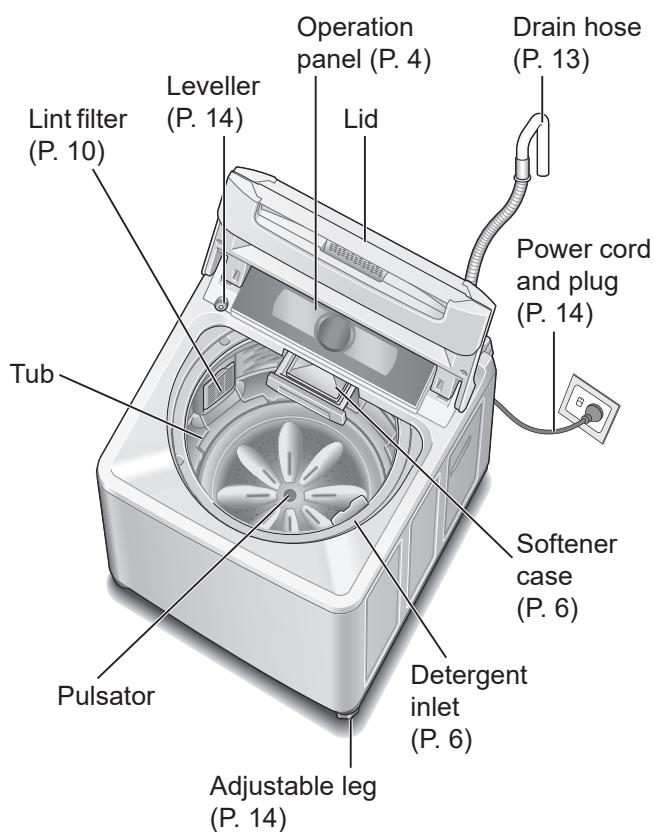

Accessories

- Water supply hose (2)
 - Length: 1.5 m
- Drain hose (1)
- Hose band (1)
- Bottom cover (1)
- Screw (1)
- Hose holder (1)
- Screw (1)



Operation Panel

Change water amount

During the wash process, press “Water Level” to change the water amount.

- Some water amounts cannot be selected depending on the program.
- When the remaining time is displayed, press “Water Level” to check the water amount.

Water amount/remaining time

99 L

After starting operation, indicates the water amount according to the amount of laundry.

Time Left
60 min

After approx. 5 seconds, indicates the approximate remaining time (min).

Water level/water amounts

Level	High 10-8	Mid 7-5	Low 4-2	Extra Low 1	Model
Detergent *					
Water amount (L)	99	88	81	74	66
	59	52	46	38	33
	93	88	81	74	66
	59	52	46	38	33

* : 1 scoop of detergent

- Each water level, except “Extra Low”, has three water amount options that can be switched while the level is lit by pressing “Water Level”.

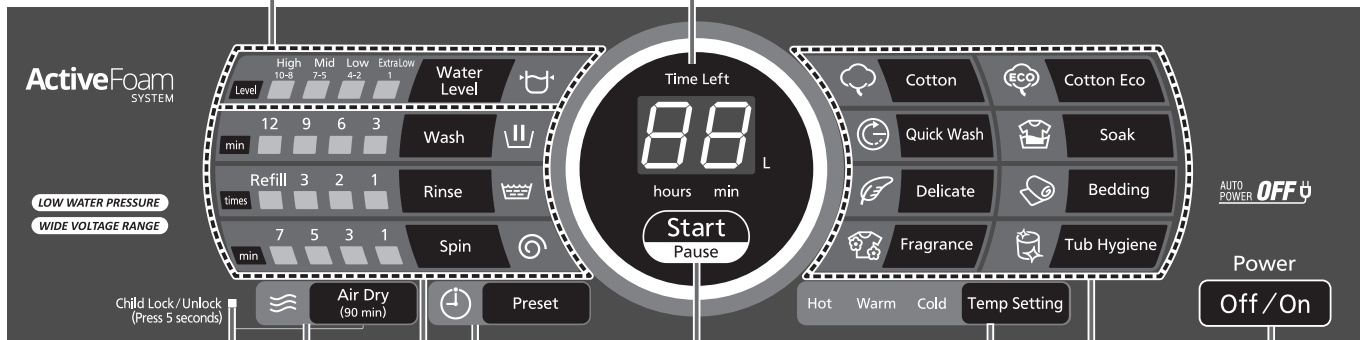

Child Lock lamp (P. 10)
Air Dry (P. 9)

Start/Pause

Program selection (P. 5)

Power Off/On

Change process settings

Change the combination of wash, rinse and spin processes, and the time length or number of times for individual processes. (P. 9)



Lighted
Flashing (in progress)

- After starting operation, you can change settings only during wash process by pressing “Start/Pause”.

Preset

Set the time to finish washing (in hours). (⌚ lights.)



e.g.) 8 hours later

- Setting range: 2 - 24 hours later, in one-hour increments. (3 - 24 hours later for the Soak program and 4-24 hours later for the Cotton Eco program)
- Not available for the following programs: Delicate, Fragrance, Bedding, Tub Hygiene, Air Dry

Temp Setting

For washing, cold water can be mixed with hot water. Press the button to select Hot/Warm/Cold. (P. 7)

Do not use water hotter than 60 °C.

- The estimated water temperature in the tub during wash process (when hot water is 50 °C, and normal water is 20 °C):



Hot	approx. 40 °C
Warm	approx. 30 °C

- Lamp indications
Lighted: Hot/Warm/Cold is set.
Flashing: Hot water is being supplied.

NOTE

- In case of a power failure during operation, operation will resume from the point where it was stopped when the power is recovered (Auto Restart).
- The power turns off automatically if you do not press “Start/Pause” within 10 minutes after power-on.

Variety of Programs

Purpose	Program	Maximum capacity		
		NA-F95G2	NA-F85G2	
Everyday clothes 	Daily washing	Cotton (P. 7)	9.5 kg	8.5 kg
Speedy washing for light soil		Quick Wash (P.7)	9.5 kg	8.5 kg
Delicates 	Washing delicates gently	Delicate (P. 8)	5.0 kg	5.0 kg
Using extra softener	Stronger scent	Fragrance (P. 7)	9.5 kg	8.5 kg
Saving washing water and energy <small>* Washing consumes less energy and water, but takes longer.</small>		Cotton Eco (P. 8)	9.5 kg	8.5 kg
Heavily soiled clothes	Presoaking to wash	Soak (P. 7)	9.5 kg	8.5 kg
Blankets 		Bedding (P. 8)	4.2 kg	4.2 kg
Drying synthetic fibre clothes		Air Dry (90 min) (P. 9)	3.0 kg	3.0 kg
Tub drying	Preventing black mould and smell	Air Dry (90 min) (P. 11)	—	—
Tub cleaning		Tub Hygiene (P. 11)	—	—

Operation Panel

Variety of Programs

Laundry preparation and check

For clothes losing colour easily
Wash separately.



Pre-laundry check

To prevent damage to clothes, malfunction and drainage failure

- Remove coins, pins, paper clips, nails, etc.
- Fasten buttons and close zippers.
- Do not wash items (such as paper diapers) other than laundry.
- Reverse clothes likely to pill.
- Use a brush to remove pet and human hair, sand, etc.
- Tie strings, etc.
- Remove any knots in clothing and any tangles.

For delicate underwear only

Use laundry nets.

- Underwire brassieres
- Lacy clothes, lingerie and stockings

When using a net

- Do not overpack.
- Put the zipper's slider into the cover. (To prevent damage to clothes and the main unit)
- Do not use the Air Dry program. (To prevent uneven drying and wrinkles)

Detergent

Put in detergent, bleach and softener according to the water amount displayed.

- Follow the instructions on each package.

■ Softener case
Softener

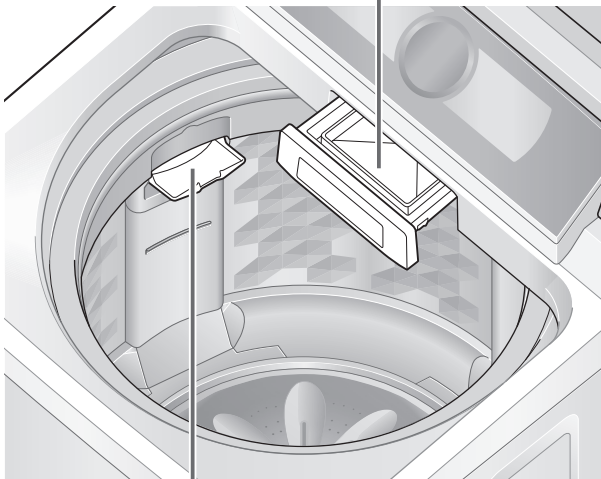

■ Detergent inlet
Detergent/Bleach

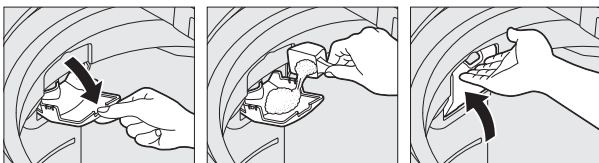

- Turn the tub by hand if it is difficult to put in the detergent inlet. (P. 10)
- Attach the detergent inlet cover if it comes off.

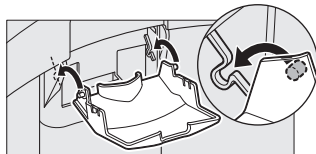

- If the detergent/bleach inlet cover is wet, wipe it before use. (Wet cover can cause detergent clumps)

Putting in detergent

Do not put detergent directly into the tub.
Detergent may remain undissolved.

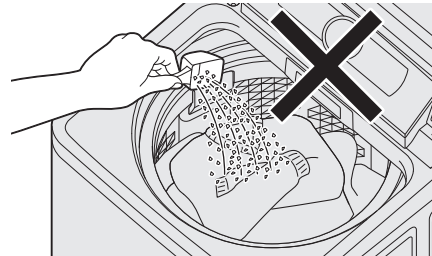

- The level of foaming depends on condition such as load size, degree of soiling, detergent type, and water hardness.

Putting in bleach

- Do not use whiten bleach (chlorine bleach) for coloured clothes to prevent loss of colour.
- Do not use bleach for the Delicate program.

Putting in softener

- Softener is automatically released during the final rinse process.
- To add softener during operation, press "Pause" first.
- Up to about 160 ml can be added. To add more softener, use the Fragrance program.
- When using concentrated softener, dilute it with water before putting it in.

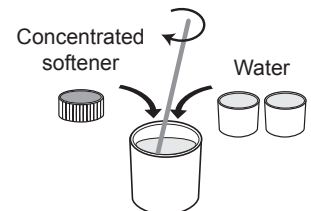

NOTE

- Do not use separated or solidified softener.
- Softener cannot be used with the Cotton Eco program.

Washing

Preparation:

- Check if the washing machine is properly installed. (P. 12)
- Turn on the water faucet.
- When using Temp Setting, turn on both hot and cold water faucets.

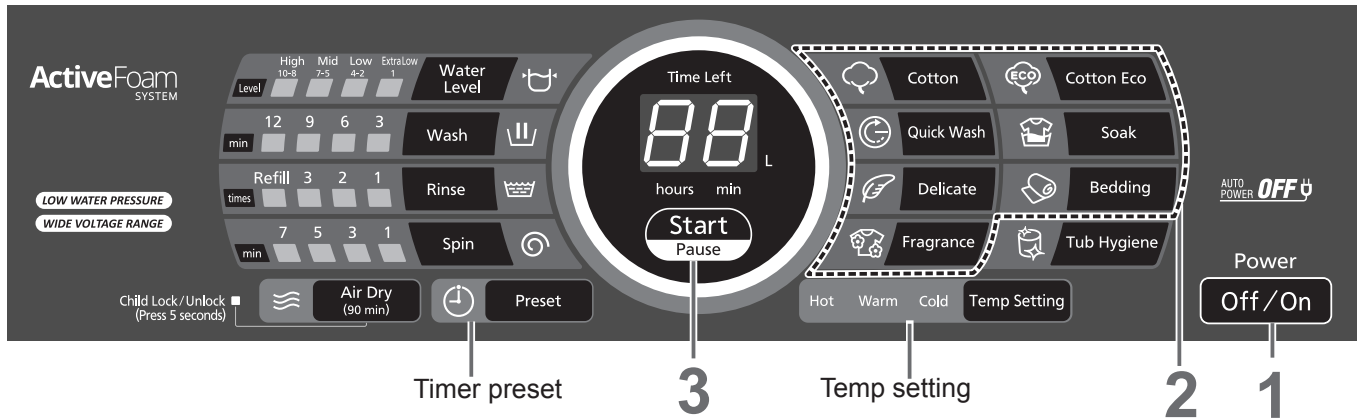

1 After loading laundry
Off/On Turn the power on.

- The Cotton program is selected when the power is turned on.

2 Select a program. (P. 5)

- Temp Setting
- Timer preset

3 **Start.**
 The pulsator moves without water and measures the amount of laundry (approx. 5 seconds).
 Water amount indication (approx. 5 seconds)
 Remaining time indication
 • To check the water amount → Press "Water Level".

4 According to the water amount indication
Put in detergent.

- Approx. 20 seconds after the water amount is displayed, water supply begins.

5 Close the lid.
 Operation ends with beeps.

Press to select Hot/Warm/Cold for washing. (P. 4)

Hot Warm Cold Temp Setting

Hot ← Warm ← Cold

Set how many hours later to finish operation. (P. 4)

Preset

- 2 minutes after start-up, all indications except ⏸ turn off.
- To confirm after the timer has been set, press **Preset**.
- To cancel or change, press **Off/On**.
- The hours that can be set differ depending on the program.

When the Fragrance program is selected

The buzzer sounds before the final rinse and operation is paused. Put the desired amount of softener which has been diluted with water directly into the tub.

Fr 5 beeps

- The Fragrance program cannot be selected when Child Lock (P. 10) is set.
- Operation will resume if the lid is left closed for more than 1 hour.

■ After pressing "Start"

- You can change the water level until the end of the wash process.
- You can change each of the "Wash", "Rinse" and "Spin" operation contents until the end of the wash process. Press "Pause" beforehand.
- You cannot change the program.

Detergent

Washing

Washing Options

Bedding

Washable blankets



- Material : 100 % synthetic fibre or 100 % cotton
- Weight : 4.2 kg or less (King size bed)
- Blankets with a machine-washable tag attached

NOTE

- Use liquid detergent.
- The water amount indication shows the maximum and cannot be changed.

Delicate

Use this program to gently wash delicate clothes and stylish garments.

Load laundry evenly



- Load lighter items first and press them from above.
- Use laundry nets for delicate underwear only.
- Amount that can be washed at one time:

Water Level	Capacity
74 L	5.0 kg
66 L	3.0 kg
59 L	1.0 kg

NOTE

- Do not use bleach.
- Use liquid delicate detergent.
- After operation ends, take out clothes immediately. (To prevent wrinkles and colour staining)

Cotton Eco

With the “Cotton Eco” cycle the washing machine consumes less energy and water.

- **Preparation** : Turn on both hot and cold water faucets. (Default setting: Hot)

About Detergent

- We recommend using high efficiency or low-sudsing detergent.
- For better performance, it is recommended to dissolve detergent in 1L of water at 35 °C and then pour it around the inner wall of the tub.
- Add detergent after the hot water fill is completed. Opening the lid to add detergent before hot water filling is completed will alter the total amount of hot water added, and hence washing performance will change.

Water amount can be adjusted according to the table below:

NA-F95G2		NA-F85G2	
Water Level	Capacity	Water Level	Capacity
59 L	9.5 kg	-	-
52 L	6.0 kg	52 L	8.5 kg
46 L	3.4 kg	46 L	6.0 kg

NOTE

- Do not use softener.
- The operation starts with the end of hot water filled.
- If “U13” appears, clothes in the tub are out of balance. Follow installation (P.16) to distribute the clothes evenly, and close the lid.
- We recommend leaving the washing machine for at least 1 hour between each use.
- Cotton Eco is for normally soiled cotton load with AS/NZS 2040.1, AS/NZS 2040.2 and AS/NZS 6400.

Air Dry (90 min)

Water is removed from clothes by the air blown from the tub rotation.

- Clothes that can be dried
 - Material: Synthetic fibre
 - Weight: 3.0 kg or less

1 After loading clothes and closing the lid
 **Turn the power on.**

2  **Press.**

3  **Start.**

After 90 minutes, drying ends with beeps.

NOTE

- Clothes may not be sufficiently dried depending on the amount and type of clothes, the temperature, and the installation condition of the washing machine.
- Since no heater is used for this function, you may feel that clothes are cold and half dry.



Wash / Rinse / Spin

Preparation: Turn on the water faucet.

1 After loading laundry
 **Turn the power on.**

2  According to your purpose
Change process settings.
 • Change the water amount as necessary.

3  **Select water temperature.**

4 After closing the lid
 **Start.**

Operation ends with beeps.

Contents of Programs

Program	Total time (approx.)	Wash	Rinse	Spin	Temp Setting	Water level ⁴⁾
Cotton	60 min	12 min	2 times	5 min	Hot Warm Cold	High
Quick Wash	55 min	9 min	2 times	5 min		Mid
Fragrance	85 min	12 min	2 times	5 min		Low
Soak	120 min ¹⁾	12 min ²⁾	2 times	5 min		Extra Low
Bedding	80 min	12 min	2 times	3 min		High
Delicate	55 min	9 min	2 times	1 min	Cold	Mid
Cotton Eco (NA-F95G2) ⁴⁾	180 min ¹⁾	12 min ²⁾	3 times	7 min ³⁾	Hot / Cold	Mid / Low
Cotton Eco (NA-F85G2) ⁴⁾	160 min ¹⁾	12 min ²⁾	3 times	7 min ³⁾		
Tub Hygiene	150 min ¹⁾	12 min ²⁾	2 times	7 min	Cold	High



NOTE

- **Total time is approximate.**
(When the standard water supply rate is 15 L / min)
- Total time may increase depending on low water pressure, bad draining conditions, and the amount and type of clothes.

- 1) Remaining time of 99 minutes or less will be displayed.

- 2) Although the time indication is "12 min", soaking is done before that. Approximate soaking time :
 - Cotton Eco : 75 min (NA-F95G2) / 61 min (NA-F85G2)
 - Soak and Tub Hygiene : 60 min
- 3) Although the time indication is "7 min", actual spinning time may take up to 25 min.
- 4) Water Level depends on loading capacity.

Convenient Functions



Cancelling end buzzer and button operation sound

-  Pressing down,  press.
 Then hold on for **3 seconds.** 2 short beeps
4 short beeps
- To reset, do the same procedure.

Setting Child Lock

To prevent children from falling into the tub and drowning, if the lid is opened while the washing machine is operating, this function sounds a buzzer until it is closed. Not closing it within 10 seconds flushes the water out.

- This function does not lock the lid and button operations.
- When water is drained forcibly, "U 99" is displayed. (P. 16)

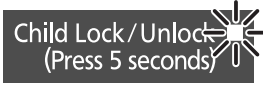
- After closing the lid  Turn the power on.
 -  Press and hold for **5 seconds.** 2 short beeps
 4 short beeps
- To cancel, do the same procedure.

Turning the tub by hand

If it is difficult to reach the detergent inlet.

-  Turn the power on.
- When a clicking sound is heard **Turn the tub within 20 seconds.** (Clockwise only)

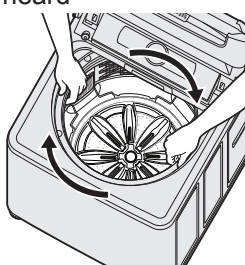

NOTE

- If there is water in the tub, the tub cannot be turned.

Maintenance

Lint filter

After each operation

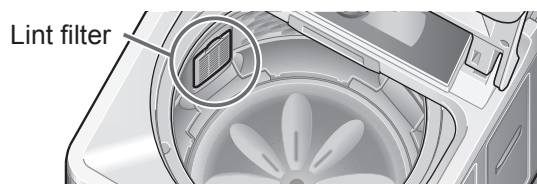

- Remove the filter gently.

- Open the filter and remove lint.

- If lint is difficult to remove, soak and wash the filter in water.

- Attach the filter in its original position.

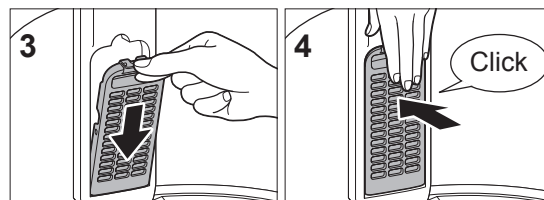
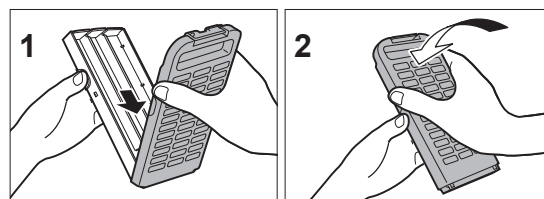

NOTE

- Do not wash laundry without the filter. (To prevent damage to clothes)
- Turn the tub by hand if it is difficult to remove the filter.
- If the filter is broken, purchase a new one at your local dealer.

Water supply filter

If water does not flow smoothly

- Follow the procedure below to prevent splashing of water.

1 After turning off both hot and cold water faucets

Off/On Turn the power on.



2 **Temp Setting** Select Hot or Warm.

3 **Start/Pause** Start.

4 After approx. 40 seconds **Off/On** Turn the power off.

5 Loosen the nut and remove the hose.

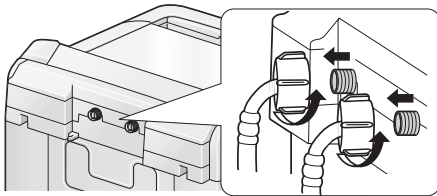

6 Remove the filter and remove dirt on the filter.

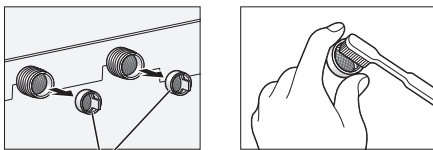

Water supply filter

7 Reattach the filter to this original position.

Main unit, lid

If stained with detergent or softener

Wipe with a soft cloth.

- (To prevent damage to resin parts or metal corrosion)
- For heavy soil, wipe with a neutral kitchen detergent.
 - Do not splash water.

Tub

Once a week <Air Dry>

1 After operation ends
Run the Air Dry program without loading laundry. (P. 9)

Once a month <Tub Hygiene>

Preparation: Turn on both hot and cold water faucets.

1 Without loading laundry **Off/On** Turn the power on.

2 **Tub Hygiene** Press.

3 **Start/Pause** Start.

Start/Pause When the tub is filled with water **Pause.**

4 Put bleach in the tub.

- Use whiten bleach (drum cleaning detergent commercially available).



Approx. 200 ml

5 After closing the lid **Start/Pause** Start.

After approx. 2 hours and a half, tub cleaning ends.

Softener case

Wash with water.

- How to remove
After pulling the case all the way out, pull it obliquely upward to remove it.

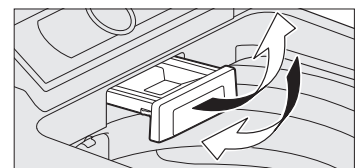

Installation

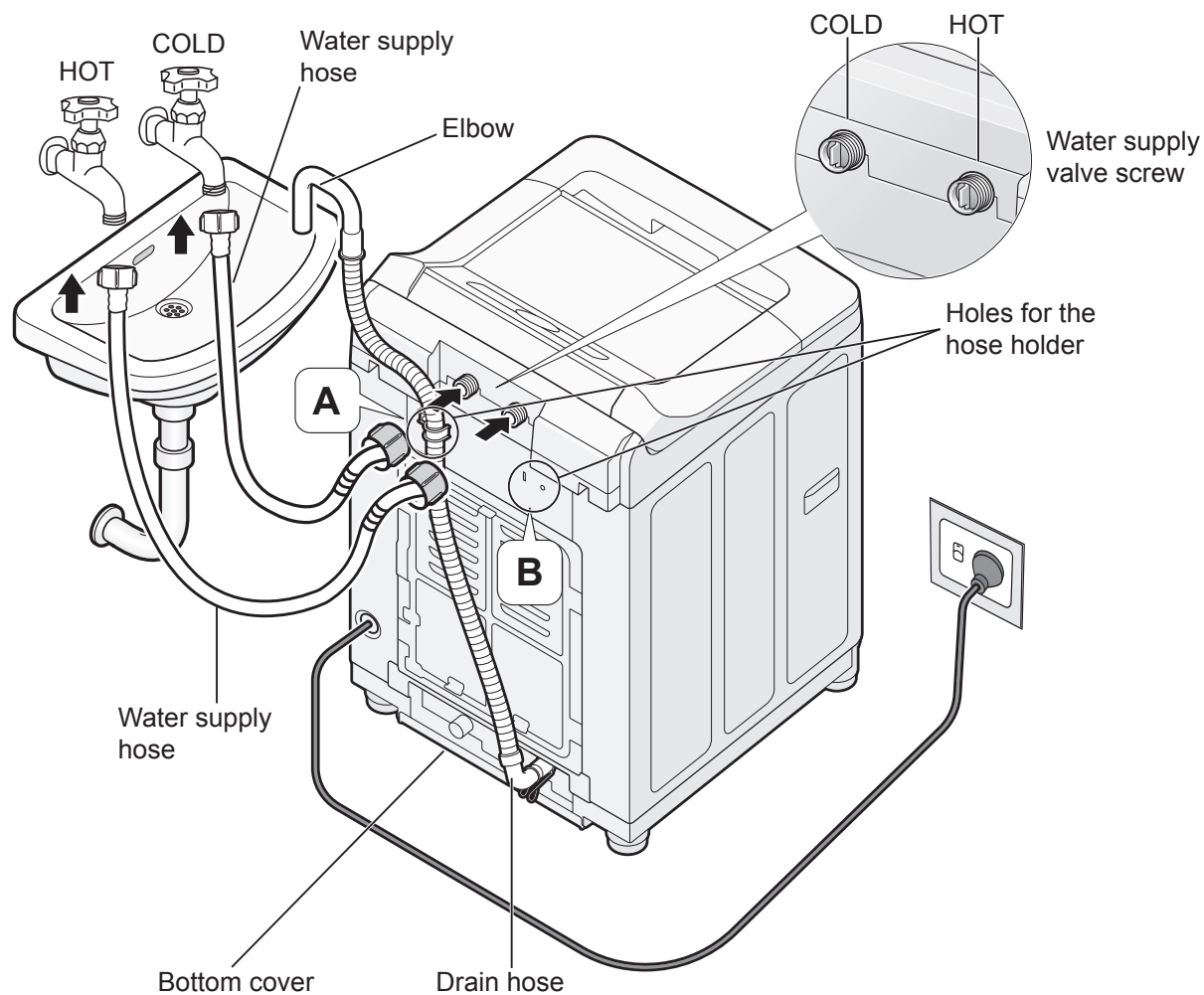

1. Check the location.

- Avoid the following locations for installation.
 - Damp locations or locations where it may be exposed to rain, etc. (To prevent electric shock or fire)
 - Uneven or unstable locations (on blocks, timbers, a table with wheels, etc.)
 - Locations with a possibility of freezing
- Keep the washing machine at least 10 cm away from the wall to minimise noise.

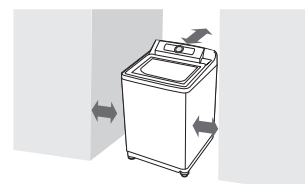

2. Attach the bottom cover.

1 Insert the bottom cover along the guides.

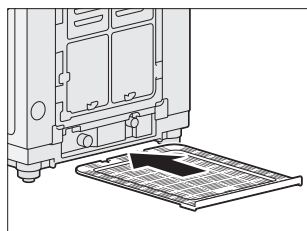

2 Fix with a screw.

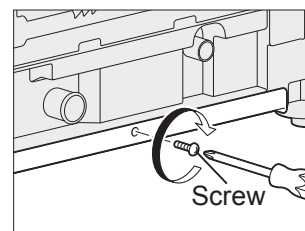

- Make sure to ask a service person for installation. Do not install by yourself.
- If the installation, test run and inspection of the washing machine are not carried out following this installation method, Panasonic will not be liable for any accident or damage caused.

3. Attach the drain hose.

1 Connect.

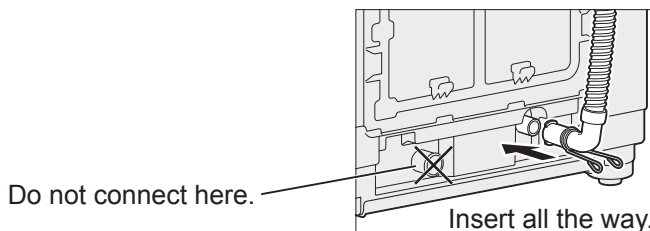

2 Slide the hose band in the arrow direction.

- Slide all the way until it stops.

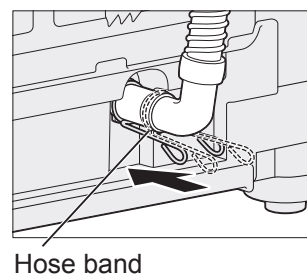

3 Attach the hose to position A or B with the hose holder and the screw.

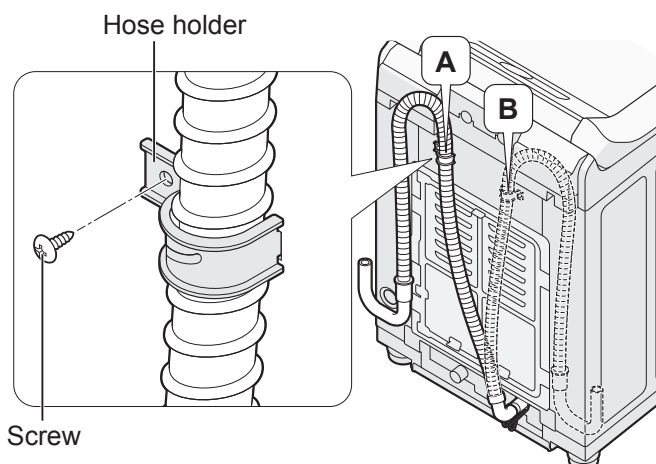

4 Hook the elbow of the drain hose to the basin.

CAUTION

Make sure the drain hose is securely hooked so that it does not come off by water pressure during drainage.

NOTE

- Do not twist, pull out or bend the drain hose.
- Do not put the hose tip under water.
- Do not direct the drain hose downwards.
- End of drain hose is not lower than high water level in the tub.
- The installation shall be in accordance with the requirements of AS/NZS 3500.1.

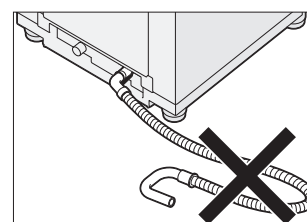
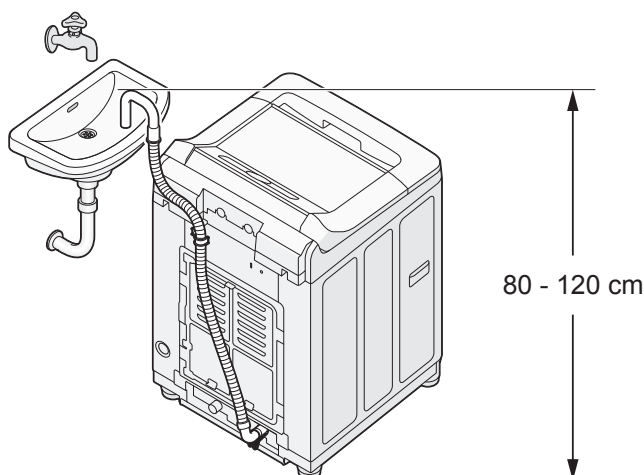

Installation (continued)

4. Connect the water supply hose.

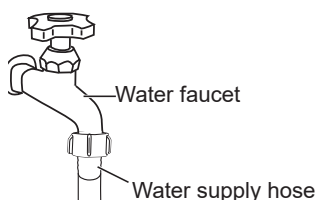

CAUTION

- Do not make wrong connection for the HOT and COLD water supply faucets.
- Tighten the nut firmly.
- Do not twist, squash, modify or cut the hose.

1 Connect the water supply hose to the water supply valve screw.

- 1 Hold the elbow and tighten the nut.
 - 2 Check that the elbow is not loose.
- The procedure for cold water and hot water is the same.

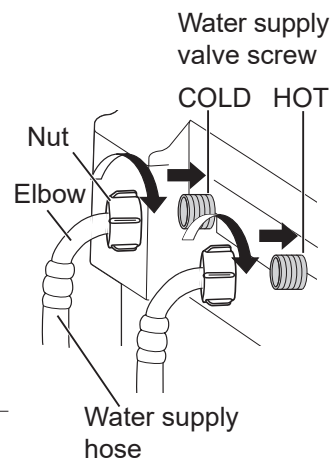

2 Connect the water supply hose to the water faucet, and tighten the nut clockwise with your hand.

3 Turn on the water faucets slowly and make sure there are no leaks.

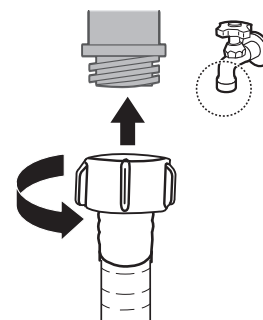

NOTE

- If you have an uncontrolled water heating source (e.g., wet back, solar heating), fit a tempering device (e.g., a safe valve). This will ensure the hot water temperature remains within safe limits. Contact a local plumber or plumbing supply merchant for the most suitable type of tempering device.
- Time for hot water to reach washing machine will depend on proximity of washing machine to hot water tank.

5. Connect the power plug and grounding wire.

- Plug the power cord into a dedicated household 3-pin AC outlet rated at 10 A, 220 V to 240 V. If you are not sure, contact a qualified electrician.

6. Check that the washing machine is level.

The bubble should be at the centre of the mark.

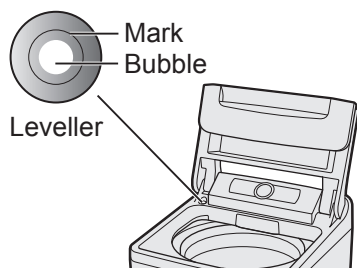

■ If the bubble is out of the mark

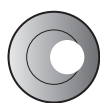

- 2 Turn the adjustable leg to eliminate wobble.

- 1 Turn the adjustable leg knob to the left to loosen.

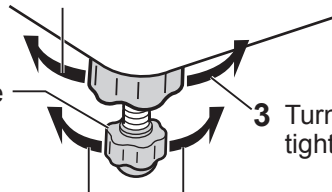

- 3 Turn to the right to tighten.

7. Perform a trial operation.







- Check that there is no water leakage, abnormal sounds or error display.

Troubleshooting

	Symptoms	Points to be checked
Time	Time indication increases or does not decrease.	<ul style="list-style-type: none"> Time indication is approximate. Remaining time is corrected during operation and displayed.
	Operation time is longer than the time indication. Operation does not stop even after the preset time.	<ul style="list-style-type: none"> The operation time may be longer if laundry is concentrated on one side or the water supply or drainage is not good. (P. 16 "U 11" "U 14")
Main unit	No operation	<ul style="list-style-type: none"> Power failure? Is the lid closed completely? Has the power fuse blown or the breaker tripped? Is the power plug inserted completely? Is the water faucet turned on? Did you press "Start"? Is the timer preset?
	Cannot change process settings (after start-up).	<ul style="list-style-type: none"> Process settings can be changed during wash process by pressing "Pause". To change the program or settings after the end of wash process, turn the power off and on again.
Wash	No water supply	<ul style="list-style-type: none"> Is the water faucet turned on? Water outage? Is the water supply filter clogged with dirt? (P. 11)
	Water is supplied in the middle of wash process.	<ul style="list-style-type: none"> If the water level drops, water is added automatically. With a large amount of laundry, water is added several times automatically.
	The water level is too high for the amount of laundry.	<ul style="list-style-type: none"> If laundry is wet or there is water in the tub before operation, the water level may be higher.
	The water level is too low for the amount of laundry.	<ul style="list-style-type: none"> With light clothes (of synthetic fibre, etc.), the water level may be lower.
Rinse/Spin	Operation started with rinse, but water is not supplied.	<ul style="list-style-type: none"> If there is no water in the tub, water is supplied after spin. If there is water in the tub, water is supplied after water discharge.
	Operation suddenly changes to rinse process in the middle of spin. Only spin is desired, but operation starts with rinse.	<ul style="list-style-type: none"> If clothes are concentrated on one side of the tub, the washing machine automatically corrects unevenness by starting rinse process. (Place clothes as evenly as possible.)
	Irregular rotation during spin	<ul style="list-style-type: none"> The tub rotation speed is adjusted to reduce foaming during spin.
Others	Power failure/ The breaker has tripped.	<ul style="list-style-type: none"> Operation will resume from the point where it was stopped when the power is recovered (Auto Restart).
	Water outage	<ul style="list-style-type: none"> When water supply is recovered, remove the water supply hose, release turbid water from the faucet, and then start the washing machine.
	Cannot select the Fragrance program.	<ul style="list-style-type: none"> If Child Lock (P. 10) is set, the Fragrance program cannot be selected.
	There is noise when water drains out.	<ul style="list-style-type: none"> This is normal. It is the noise of the drain pump working.

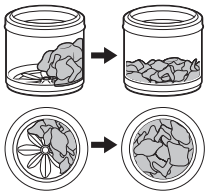
Error Display

- The buzzer sounds and “U”/“H” and a number are alternately displayed.
- Cancel Child Lock (P. 10) if it is set.

Error display	Points to be checked
	<p>Water cannot drain. Check the drain hose for the following abnormalities:</p> <ul style="list-style-type: none"> • Is it crushed? • Is it clogged with lint? • Is the hose tip under water? <p>When the above problems are solved, you can resume operation by opening and closing the lid.</p>
	<p>The lid is open.</p> <ul style="list-style-type: none"> • Did you try to run the washing machine with the lid open? →Close the lid.
	<p>Spin or Air Dry is not possible.</p> <ul style="list-style-type: none"> • Are clothes concentrated on one side of the tub? →Distribute the clothes evenly and close the lid. • Is the washing machine installed on an unstable or inclined surface? →You can resume operation by opening and closing the lid. 
	<p>Water cannot be supplied.</p> <ul style="list-style-type: none"> • Is the water faucet turned on? →When using Temp Setting, turn on both hot and cold water faucets. • Water outage? • Is the water supply filter clogged with dirt? (P. 11) →You can resume operation by opening and closing the lid.
	<p>Water has been forcibly drained.</p> <ul style="list-style-type: none"> • Water has been forcibly drained because the lid was open for 10 seconds or more with Child Lock (P. 10) set. →Unplug the power cord and plug it in again after 5 seconds.
	<p>Inspection is required.</p> <ul style="list-style-type: none"> • Turn off the water faucet just to be safe. Then, report the error displayed (2-digit number after “H”) to a service person. Unplug the power cord.

Specifications

	NA-F95G2	NA-F85G2
Rated voltage	220 - 240 V	
Rated frequency	50 Hz	
Rated power consumption	590 W	580 W
Standard water amount	99 L	93 L
Maximum mass of dry cloth	9.5 kg	8.5 kg
Product dimensions	643 mm (W) x 709 mm (D) x 1074 mm (H)	
Product weight	48 kg	
Pressure of tap water	0.01 - 1 MPa	

Panasonic Corporation

<http://www.panasonic.com>

© Panasonic Appliances (Thailand) Co., Ltd. 2019

Panasonic Customer Care Centre

(For Australia)

Phone: 132 600

Open: 8:30 a.m. to 6:00 p.m. Monday to Friday

(For New Zealand)

Phone: 09 272 0178

Open: 8:30 a.m. to 5:00 p.m. Monday to Friday