

# Panasonic®

## Operating Instruction and Cook Book Microwave Oven Household Use Only



Model No. NN-ST75LW  
NN-ST75LB  
NN-ST78LS



NN-ST78LS

Please read these instructions carefully before using this product,  
and save this manual for future use.

We are glad you have chosen to purchase a PANASONIC microwave oven. Before operating this oven, please read these instructions carefully and completely, and keep them for further reference.

If you have only used a microwave oven for reheating and defrosting, with Panasonic's Inverter Technology you can be reassured of excellent results when cooking a variety of foods, as the 'soft' penetration of microwave energy to the centre of food helps prevent over cooking on edges and surfaces. Foods can now be gently simmered without the concern of boil over.

After reading the introductory chapter, we are sure you will be able to master the basic techniques and thereby develop a firm understanding of your new oven. This book includes recipes from starters to desserts. After trying our recipes be sure to adapt your favourite recipes to microwave methods.

Start experimenting now, and enjoy the first class results you will achieve by using your new microwave oven.

Panasonic Australia Pty Ltd  
1 Innovation Road  
Macquarie Park  
NSW 2113



Panasonic NZ Ltd  
Customer Care Centre  
18 Sir Woolf Fisher Drive  
Highbrook, Auckland  
Private Bag 14911  
Panmure, Auckland

Phone: (09) 272 0178  
Fax: (09) 272 0129

The serial number of this product may be found on the back side of the oven. You should note the model number and serial number of this oven in the space provided and retain this book as a permanent record of your purchase for future reference.

MODEL NUMBER \_\_\_\_\_

SERIAL NUMBER \_\_\_\_\_

DATE OF PURCHASE \_\_\_\_\_

# Table of Contents

## Before Operation

Important Safety Instructions.....	6-7
Installation and General Instructions.....	7-8
Microwaves and How They Work.....	9
Cookware and Utensils Guide.....	9-10
Feature Diagram.....	11
Control Panel.....	12
Ingredient Conversion Chart.....	27

## Operation and Hints

Quick Guide to Operation.....	4-5
Let's Start To Use Your Oven!.....	13
Display Window.....	13
To Set Clock.....	14
To Use Child Safety Lock.....	14
To Cook on Micro Power by Time Setting.....	15
To Use Keep Warm Feature.....	16
To Defrost Using Turbo Defrost.....	17
To Cook Using the Quick 30 Feature.....	18
Using the Add Time Feature.....	19
To Use Sensor Reheat Feature.....	20
To Use Beverage Feature.....	21
To Use Sensor Cook Menus.....	22-25
To Use Melt & Soften Feature.....	26
3-Stage Setting.....	27
To Use Timer.....	28
Defrosting Chart.....	29
Reheating Chart.....	30
Cooking Chart.....	31



## Maintenance

Before Requesting Service.....	32
Care of Your Microwave Oven.....	33
Technical Specifications.....	34
Panasonic Warranty.....	35-36





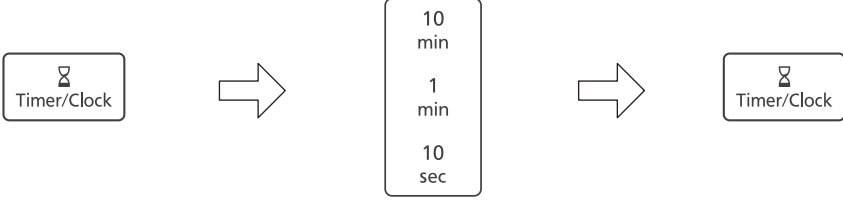
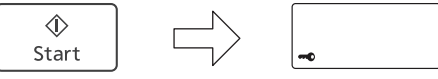
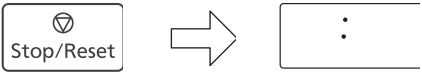
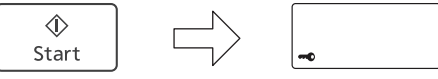
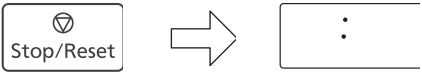
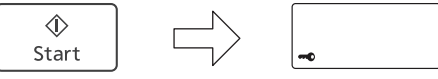
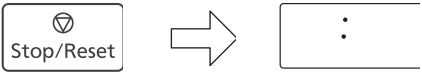
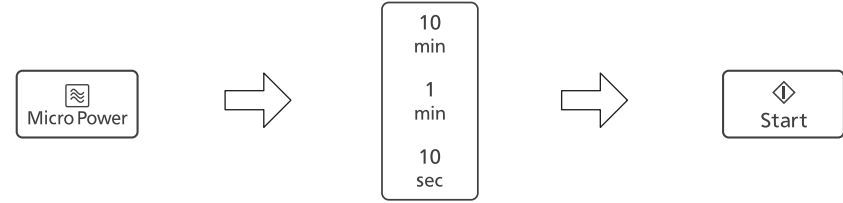
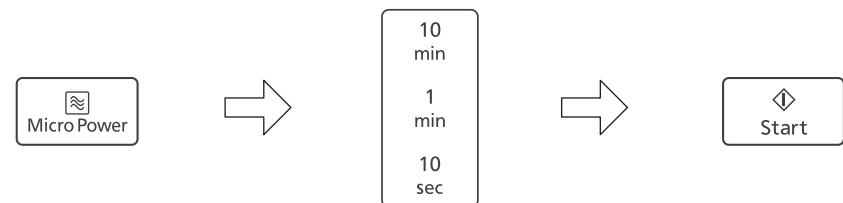

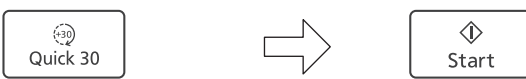
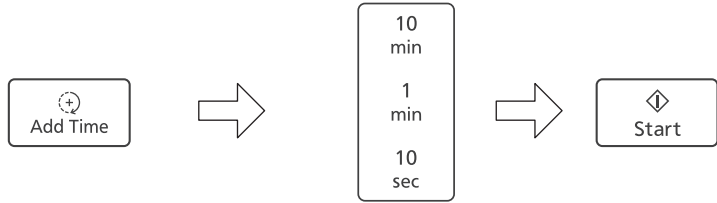











## Cooking Guide

Microwave Recipe Techniques.....	37-39
Reheat.....	40-42
Soups and Snacks.....	43-44
Fish and Shellfish.....	45-46
Poultry and Eggs.....	47-50
Main Fare Meats.....	51-54
Vegetables and Legumes.....	55-60
Rice, Pasta and Noodles.....	61-64
Cakes, Desserts and Slices.....	65-69
Sauces and Extras.....	70

# Quick Guide to Operation

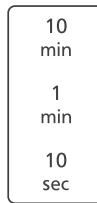
Feature	How to Operate					
<b>To Set Clock</b> (see page 14)	 <p>Press twice                      Enter time of day (12-hour)                      Press once</p>					
<b>To Set/Cancel Child Safety Lock</b> (see page 14)	<table border="0" style="width: 100%; border-collapse: collapse;"> <tr> <td style="width: 50%; border-right: 1px dashed black; vertical-align: top;"> <b>To set</b>   <p>Press 3 times                      Display</p> </td> <td style="width: 50%; vertical-align: top;"> <b>To cancel</b>   <p>Press 3 times                      Display</p> </td> </tr> <tr> <td colspan="2" style="text-align: right; border-top: 1px dashed black;">                     Colon or time of day reappear in the display                 </td> </tr> </table>		<b>To set</b>  <p>Press 3 times                      Display</p>	<b>To cancel</b>  <p>Press 3 times                      Display</p>	Colon or time of day reappear in the display	
<b>To set</b>  <p>Press 3 times                      Display</p>	<b>To cancel</b>  <p>Press 3 times                      Display</p>					
Colon or time of day reappear in the display						
<b>To Cook/Defrost on Micro Power by Time Setting</b> (see page 15)	 <p>Select power level                      Set time                      Press once</p>					
<b>To Use Keep Warm</b> (see page 16)	 <p>Press 11 times                      Set time                      Press once</p>					
<b>To Use Turbo Defrost</b> (see page 17)	 <p>Press once                      Select desired weight                      Press once</p>					
<b>To Cook Using the Quick 30</b> (see page 18)	 <p>Set cooking time                      Press once</p>					
<b>To Use Add Time</b> (see page 19)	 <p>Press once after cooking                      Set time                      Press once</p>					

# Quick Guide to Operation (continued)

Feature	How to Operate
<b>To Use Sensor Reheat</b> (see page 20)	 →  Press once                      Press once
<b>To Use Beverage</b> (see page 21)	 →  →  Press until desired menu number appears      Select Serving/Weight      Press once
<b>To Use Sensor Cook</b> (see page 22-25)	<b>e.g. Frozen Vegetables.</b>  →  Press 3 times                      Press once
<b>To Use Melt &amp; Soften</b> (see page 26)	 →  →  Press until desired menu number appears      Select Serving/Weight      Press once
<b>To Use Kitchen Timer</b> (see page 28)	 →  →  Press once                      Set time                      Press once
<b>To Set Standing Time</b> (see page 28)	<b>Set the desired cooking programme, up to 2 stages (see page 27)</b> →  →  →  Press once                      Set time                      Press once
<b>To Set Delay Start</b> (see page 28)	 →  → <b>Set the desired cooking programme, up to 2 stages (see page 27)</b> →  Press once                      Set time                      Press once



# Important Safety Instructions

## READ CAREFULLY AND KEEP FOR FUTURE REFERENCE

### Precautions To Be Taken When Using Microwave Ovens For Heating Foodstuffs

#### INSPECTION FOR DAMAGE:

A microwave oven should only be used if an inspection confirms all of the following conditions:

1. The door fits squarely and securely and opens and closes smoothly.
2. The door hinges are in good condition.
3. The metal plates of a metal seal on the door are neither buckled nor deformed.
4. The door seals are neither covered with food nor have large burn marks.

#### PRECAUTIONS:

Microwave radiation from microwave ovens can cause harmful effects if the following precautions are not taken:

1. Never tamper with or deactivate the interlocking devices on the door.
2. Never poke an object, particularly a metal object, through a grille or between the door and the oven while the oven is operating.
3. Never place saucepans, unopened cans or other heavy metal objects in the oven.
4. Do not let other metallic articles, e.g. fast food foil containers, touch the side of the oven.
5. Clean the oven cavity, the door and the seals with water and a mild detergent at regular intervals. Never use any form of abrasive cleaner that may scratch or scour surfaces around the door.
6. Always use the oven with the trays or cookware recommended by the manufacturer.
7. Never operate the oven without a load (i.e. an absorbing material such as food or water) in the oven cavity unless specifically allowed in the manufacturer's literature.
8. For horizontally hinged doors, never rest heavy objects such as food containers on the door while it is open.
9. Do not place sealed containers in the microwave oven. Baby bottles fitted with a screw cap or a teat are considered to be sealed containers.
10. This appliance is not intended for use by persons (including children) with reduced physical, sensory or mental capabilities, or lack of experience and knowledge, unless they have been given supervision or instruction concerning use of the appliance by a person responsible for their safety.
11. Children should be supervised to ensure that they do not play with the appliance.
12. It is hazardous for anyone other than a competent person to carry out any service or repair operation that involves the removal of a cover which gives protection against exposure to microwave energy.
13. The surfaces are liable to get hot during use.

### Important Instructions

WARNING—To reduce the risk of burns, electric shock, fire, injury to persons or excessive microwave energy:

1. Read all instructions before using the microwave oven.
2. Some products such as whole eggs and sealed containers - (for example, closed glass jars **and sealed baby bottles with teat**) - may explode and should not be heated in the microwave oven.
3. Use this microwave oven only for its intended use as described in this manual.
4. As with any appliance, close supervision is necessary when used by children.
5. Do not operate this microwave oven, if it is not working properly, or if it has been damaged or dropped.
6. Do not store or use this appliance outdoors.
7. Do not immerse cord or plug in water.
8. Keep cord away from heated surfaces.
9. Do not let cord hang over edge of table or counter.
10. To reduce the risk of fire in the oven cavity:
  - (a) Do not overcook food. Carefully attend microwave oven if paper, plastic, or other combustible materials are placed inside the oven to facilitate cooking.
  - (b) Heating therapeutic wheat bags is not recommended. If heating, do not leave unattended and follow manufacturers' instructions carefully.
  - (c) Remove wire twist-ties from bags before placing bag in oven.
  - (d) If materials inside the oven should ignite, keep oven door closed, turn oven off at the wall switch, or shut off power at the fuse or circuit breaker panel.
  - (e) Never leave microwave unattended while cooking or reheating.
11. Do not remove outer panel from oven.
12. Appliances are not intended to be operated by means of an external timer or separate remote-control system.
13. Failure to maintain the oven in a clean condition could lead to deterioration of the surface that could adversely affect the life of the appliance and possibly result in a hazardous situation.

### Circuits

Your microwave oven should be operated on a separate 10 A circuit from other appliances. Failure to do this may cause the power board fuse to blow, and/or food to cook slower. Do not insert higher value fuse in the power board.

# Important Safety Instructions (continued)

## Earthing Instructions

This microwave oven must be earthed. In the event of an electrical short circuit, earthing reduces the risk of electric shock by providing an escape wire for the electric current. This microwave oven is equipped with a cord having an earthing wire with an earthing plug. The plug must be plugged into an outlet that is properly installed and earthed.

WARNING—Improper use of the earthing plug can result in a risk of electric shock.

WE CERTIFY THAT THIS MICROWAVE OVEN HAS BEEN INSPECTED AND COMPLIES WITH THE REQUIREMENTS OF REGULATION 3, SUBCLAUSE(2), OF THE MICROWAVE OVENS REGULATIONS 1982.

(This statement applicable only to New Zealand.)

We certify that this microwave oven has been inspected and complies with the safety requirements of government notice 466 of March 1981, and complies with the Radio Regulation of government notice 587 of March 1986.

(This statement applicable only to South Africa)

## WARNING

- a) The door seals and door seal areas should be cleaned with a damp cloth. The appliance should be inspected for damage to the door seals and door seal areas and if these areas are damaged the appliance should not be operated until it has been repaired by a qualified service technician trained by the manufacturer.
- b) If the door or door seals are damaged, the oven must not be operated until it has been repaired by a competent person.
- c) It is hazardous for anyone other than a competent person to carry out any service or repair operation that involves the removal of a cover which gives protection against exposure to microwave energy.
- d) If the supply cord is damaged, it must be replaced by the manufacturer, its service agent or similarly qualified persons in order to avoid a hazard.
- e) Before use, the user should check that whether the utensils are suitable for use in microwave ovens.
- f) Liquids and other foods must not be heated in sealed containers since they are liable to explode.
- g) Only allow children to use the oven without supervision when adequate instructions have been given so that the child is able to use the oven in a safe way and understands the hazards of improper use.
- h) Care should be taken not to displace the glass tray when removing containers from the appliance.

# Installation and General Instructions

## General Use

1. In order to maintain high quality, do not operate the oven when empty. The microwave energy will reflect continuously throughout the oven if no food or water is present to absorb energy. This can lead to damage to the microwave oven including arcing within the oven cavity.
2. If smoke is observed, press the **Stop/Reset** pad and leave door closed in order to stifle any flames. Disconnect the power cord, and/or shut off power at the fuse or circuit breaker panel.
3. Do not dry clothes, newspapers or other materials in oven. They may catch on fire.
4. Do not use recycled paper products, unless the paper product is labelled as safe for microwave oven use. Recycled paper products may contain impurities which may cause sparks and/or fires when used.
5. Do not use newspapers or paper bags for cooking.
6. Do not hit or strike the Control Panel. Damage to controls may occur.
7. POT HOLDERS may be needed as heat from food is transferred to the cooking container and from the container to the Glass Tray. The Glass Tray can be very hot after removing the cooking container from the oven.
8. Do not store flammable materials next to, on top of, or in the oven. It could be a fire hazard.
9. Do not cook food directly on Glass Tray unless indicated in recipes. (Food should be placed in a suitable cooking utensil.)
10. **DO NOT** use this oven to heat chemicals or other non-food products. **DO NOT** clean this oven with any product that is labelled as containing corrosive chemicals. **The heating of corrosive chemicals in this oven may cause microwave radiation leaks.**
11. If Glass Tray is hot, allow to cool before cleaning or placing in water.
12. During cooking, some steam will condense inside and/or on the oven door. This is normal and safe. Steam will disappear after the oven cools down.

# Installation and General Instructions (continued)

13. Do not leave the microwave unattended while reheating or cooking food in disposable containers made of plastic, paper or other combustible materials, as these types of containers can ignite if overheated.
14. The microwave oven is intended for heating food and beverages. Drying of food or clothing and heating of warming pads, slippers, sponges, damp cloth and similar may lead to risk of injury, ignition or fire.
15. Metallic containers for food and beverages are not allowed during microwave cooking.
16. Only use utensils that are suitable for use in microwave ovens.

## Placement of Oven

1. The oven must be placed on a flat, stable surface. For correct operation, the oven must have sufficient air flow. **Allow more than 15 cm of space on the top of the oven, 10 cm at the back, and 5 cm on both sides. If one side of the oven is placed flush to wall, the other side or top must not be blocked. Do not remove feet.**
  - (a) Do not block air vents. If they are blocked during operation, the oven may be overheated and damaged. When using any cloth over the oven, the air intake and exhaust should not be blocked. Also allow sufficient space on back and both sides of the oven.
  - (b) Do not place oven near a hot or damp surface such as a gas stove, electric range or sink etc.
  - (c) Do not operate oven when room humidity is too high.
2. This oven was manufactured for household use only.

## Building-in your oven (only for NN-ST78LS)

1. This oven is intended for counter-top and built-in use only. It is not intended for use inside a cupboard. This oven may be built into a wall cabinet by using the proper trim kit (NN-TK712SSQP) which may be purchased from your local Panasonic dealer.
2. In case of fitting into an oven housing, please use Panasonic's Trim Kit, NN-TK712SSQP.
3. Microwave ovens should not be built into a unit directly above a top front venting conventional cooker. This may be a safety hazard and could result in damage to your oven. This will invalidate your one year guarantee.
4. A microwave which is built in must be more than 850 mm above floor level. Read Trim-Kit instructions carefully before installation. It is recommended that the microwave oven is placed below a conventional oven to avoid heat damage to the fascia of the microwave.

## Food

1. Do not use your oven for home canning or the heating of any closed jar. Pressure will build up and the jar may explode. In addition, the microwave oven cannot maintain the food at the

- correct canning temperature. Improperly canned food may spoil and be dangerous to consume.
2. Do not attempt to deep fat fry in your microwave oven.
3. Eggs in their shell and whole hard-boiled eggs should not be heated in microwave ovens since they may explode, even after microwave heating has ended.
4. Potatoes, apples, egg yolks, chicken wings, whole squash and sausages are examples of foods with nonporous skins. This type of food must be pierced before cooking, to prevent bursting.
5. When heating liquids, e.g. soup, sauces and beverages, in your microwave oven, overheating the liquid beyond boiling point can occur without evidence of bubbling. This could result in a sudden boil over of hot liquid. To prevent this possibility the following steps should be taken:
  - (a) Avoid using straight-sided containers with narrow necks.
  - (b) Do not overheat.
  - (c) Stir the liquid before placing the container in the oven and halfway through cooking time.
  - (d) After heating, allow to stand in the oven for a short time, stirring again before carefully removing the container.
  - (e) Microwave heating of beverages can result in delayed eruptive boiling, therefore care should be taken when handling the container.
6. **DO NOT USE A CONVENTIONAL MEAT THERMOMETER IN THE MICROWAVE OVEN. To check the degree of cooking of roasts and poultry use a MICROWAVE THERMOMETER.** Alternatively, a conventional meat thermometer may be used after the food is removed from the oven. If undercooked, return meat or poultry to the oven and cook for a few more minutes at the recommended power level. It is important to ensure that meat and poultry are thoroughly cooked.
7. **COOKING TIMES given in the Cooking Guide section are APPROXIMATE.** Factors that may affect cooking time are preferred degree of moisture content, starting temperature, altitude, volume, size, shape of food and utensils used. As you become familiar with the oven, you will be able to adjust for these factors.
8. **It is better to UNDERCOOK RATHER THAN OVERCOOK foods.** If food is undercooked, it can always be returned to the oven for further cooking. If food is overcooked, nothing can be done. Always start with minimum cooking times recommended.
9. Extreme care should be taken when cooking popcorn in a microwave oven. Cook for minimum time as recommended by manufacturer. Use the directions suitable for the wattage of your microwave oven. NEVER leave oven unattended when popping popcorn.
10. When heating food in plastic or paper containers, keep an eye on the oven due to the possibility of ignition.
11. The contents of feeding bottles and baby food jars shall be stirred or shaken and the temperature checked before consumption, in order to avoid burns.



# Microwaves and How They Work

Microwaves are a form of high frequency radio waves similar to those used by a radio, including AM, FM and CB. They are similar to a television where the radio waves are converted to a picture on the screen. However, microwaves are much shorter than radio waves; approximately twelve centimetres wave length. Electricity is converted into microwave energy by the magnetron tube (which is the heart of the microwave oven).

From the magnetron tube, microwave energy is transmitted to the oven cavity through a small plastic covered piece. The microwaves are converted to heat in the food. The microwaves enter from the outside of the food and travel through the food losing half of their power every two to three centimetres. Continued cooking to the centre occurs by conduction.

Although pacemakers used to be affected by microwaves (as well as by other radio waves), they are now shielded and are not bothered by these interferences. This allows people with pacemakers to sit calmly by their radio or television and cook with microwave ovens.

When microwaves come in contact with a substance, any one or combination of three things may occur.

They can be:

1. REFLECTED
2. TRANSMITTED
3. ABSORBED

## Reflection:

Metal substances REFLECT microwave energy and because there is no absorption, there is no heating. This is why the oven interior is either stainless steel or epoxy-coated steel. This ensures that the microwaves are kept inside the cavity and evenly distributed throughout the food with the help of the Glass Tray.

## Transmission:

Such substances as paper, glass and plastic TRANSMIT microwave energy and do not become hot except from food. Because these substances do not reflect or absorb microwave energy, they are ideal materials for microwave cooking containers.

## Absorption:

Food contains moisture and will ABSORB microwave energy, which causes the moisture molecules within the food to vibrate at an incredible rate (2,450,000,000 times per second). Friction, created by the vibration, produces heat energy which is conducted throughout the food.

# Cookware and Utensils Guide

It is important to use the correct container when cooking in a microwave oven. The following will help you make the right selection.

Metallic containers for food and beverages are not allowed during microwave cooking.

## How to Test a Container for Safe Microwave Oven Use

**TO TEST A CONTAINER FOR SAFE MICROWAVE OVEN USE:** Fill a 1-cup glass measure with cool water and place it in the microwave oven alongside the empty container to be tested; **heat one (1) minute at P10**. If the container is microwave oven safe (transparent to microwave energy), the container should remain comfortably cool, the water in glass measure should be hot. If the container is hot, it has absorbed some microwave energy and should NOT be used. This test cannot be used for plastic containers.

## Paper Products and Freezer Wrap

Waxed paper, paper plates, cups and napkins should not be used for heating or cooking food. Freezer wrap should not be used as it is not heat resistant and may melt. Paper towel, greaseproof paper and bake paper may be safely used for short periods of time for covering or lining.

## Glass, Ceramic and China

**Heat-Resistant glass cookware** is invaluable in microwave cooking. Many of these items are readily available in most homes: glass jugs, mixing bowls, loaf dishes, covered casseroles, oblong baking dishes, pie plates and round or square cake dishes. Examples of this type of cookware are Pyrex® and Corningware®.

**Dinnerware** can be used for microwave heating. Many brands of dinnerware are microwave safe. Check the care information for reference to microwave use for dinnerware and serving pieces. If dinnerware is marked ovenproof, it frequently is safe to use in the microwave oven. However, to be sure, check by conducting microwave dish test previously mentioned.

**Several types of glassware and dinnerware** are not recommended for use in the microwave oven. Do not use dishes with metallic trim or containers with metal parts. Do not use cups or mugs with glued on handles, as they may fall off with continued heating. Do not use delicate glassware. Although the glassware may be transparent to microwave energy the heat from the food may cause the glassware to crack.

# Cookware and Utensils Guide (continued)

## Plastics

**Plastic dishes, cups and some freezer containers** should be used with care in a microwave oven.

Choose plastic containers carefully, as some plastic containers may become soft, melt and may scorch. The majority of plastic dishes, even those designed for use in the microwave oven, are not suitable for cooking foods with high fat or sugar content, or for lengthy cooking times. Most microwave plastic dishes should not be used for longer than 3 to 5 minutes on **P10**. These dishes, although not suitable for extended cooking, may be used successfully for defrosting or for use on lower power levels.

**Cooking Bags** designed to withstand boiling, freezing, or conventional heating are microwave safe. Prepare bags according to manufacturer's directions. When cooking by microwave, **DO NOT** use wire twist-ties to close bag. They can act as an antenna and cause arcing (sparks).

**DO NOT COOK IN PLASTIC FOOD STORAGE BAGS.**

**Plastic Wrap** such as GLAD WRAP® can be used to cover dishes in most recipes. Over an extended heating time, some disfiguration of the wrap may occur. When removing plastic wrap "covers", as well as any glass lid, be careful to remove it away from you to avoid steam burns.

Loosen plastic but let dish stand, covered.

## Jars and Bottles

Jars and bottles can be used to warm food to serving temperature, if the lid is removed first. Cooking should not be done in these containers since most are not heat resistant and during extended heating times, heat from food would cause cracking or breaking.

## Metal

Metal cookware or utensils, or those with metallic trim, should **NOT** be used in the microwave. Since microwave energy is reflected by metal, foods in metal containers will not cook evenly. There is also a possibility of "arcing".

Although metal utensils should be avoided in microwave cooking, some metal can be helpful when used correctly.

Aluminum foil can be used safely, if certain guidelines are followed, to prevent overcooking. Small pieces of foil are used to shield areas such as chicken wings, tips of roasts, or other thin parts that cook before the rest of the recipe is finished. Make sure foil is attached securely and doesn't touch sides of oven, otherwise arcing may occur. Foil lined containers, either cardboard or plastic, should **NOT** be used in the microwave oven as arcing could occur.

Metal twist-ties, either paper or plastic coated, should **NOT** be used in the microwave oven. Frozen dinner trays can be used in the microwave, if the container is no deeper than 2 cm and is filled with food. Metal skewers can not be used in microwave ovens as arcing may occur. Wooden skewers are readily available and give the same result.

**Shells:** Scalloped baking shells are best used during reheating and for short periods of cooking time only.

**Thermometers** are available for use in microwave ovens. **DO NOT USE CONVENTIONAL MERCURY TYPE CANDY OR MEAT THERMOMETERS** in food while cooking in the microwave oven.

## Straw, Wicker and Wood

Straw and wicker baskets may be used in the microwave oven for short periods of time to warm rolls or bread. Large wooden utensils, such as bowls or cutting boards should **NOT** be used for prolonged heating as the microwave energy may cause the wood to become dry and brittle.

# Feature Diagram

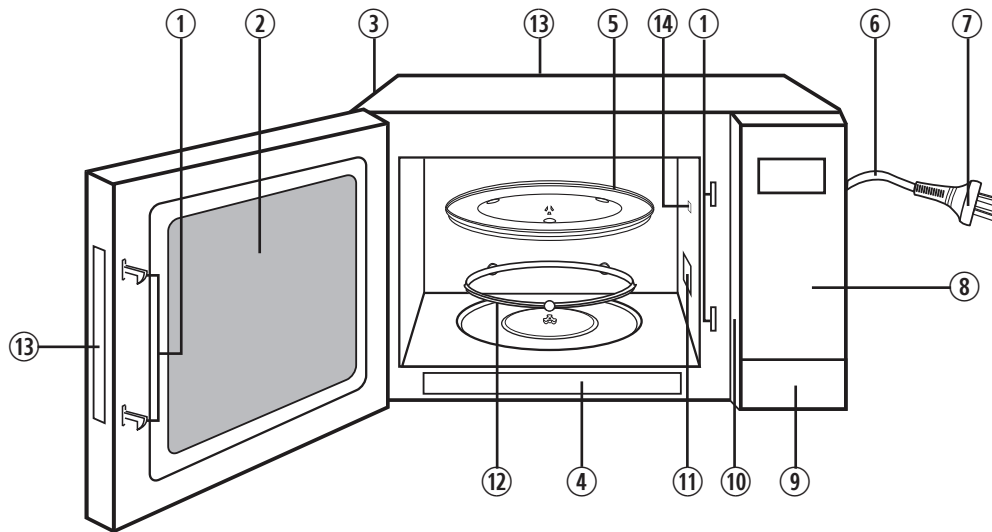

① **Door Safety Lock System**

② **Oven Window**

Oven window with vapor barrier film  
(do not remove)

③ **Oven Air Vent**

④ **Menu Label**

⑤ **Glass Tray**

- a. **DO NOT** operate the oven without the Roller Ring and Glass Tray in place.
- b. Only use the Glass Tray specifically designed for this oven. Do not substitute any other Glass Tray.
- c. If the Glass Tray is hot, allow to cool before cleaning or placing in water.
- d. **DO NOT** cook directly on the Glass Tray. Always place food on a microwave-safe dish, or on a rack set in a microwave-safe dish.
- e. Always place the container on the center of glass tray when cooking.
- f. If food or utensil on the Glass Tray touches oven walls, causing the tray to stop moving, the tray will automatically rotate in the opposite direction. This is normal.
- g. Glass Tray can rotate in either direction.

⑥ **Power Supply Cord**

⑦ **Power Supply Plug**

⑧ **Control Panel**

⑨ **Door Release Button**

Push to open the door. Opening the door during cooking will stop the cooking process without cancelling the program. Cook resumes as soon as the door is closed and **Start** pad is pressed. It is quite safe to open the door at any time during a cooking program and there is no risk of Microwave exposure.

⑩ **Identification Plate**

⑪ **Waveguide Cover** (do not remove)

⑫ **Roller Ring**

- a. Roller Ring should be cleaned regularly to avoid excessive noise.
- b. Roller Ring and Glass Tray should be used at the same time.

⑬ **Warning Label**

⑭ **Oven Light**

Oven light will turn on during cooking and also when door is opened.



## Note

1. The above illustration is for reference only.
2. The Glass Tray is the only accessory with this oven. All other cooking utensils mentioned in this manual must be purchased separately.

# Control Panel

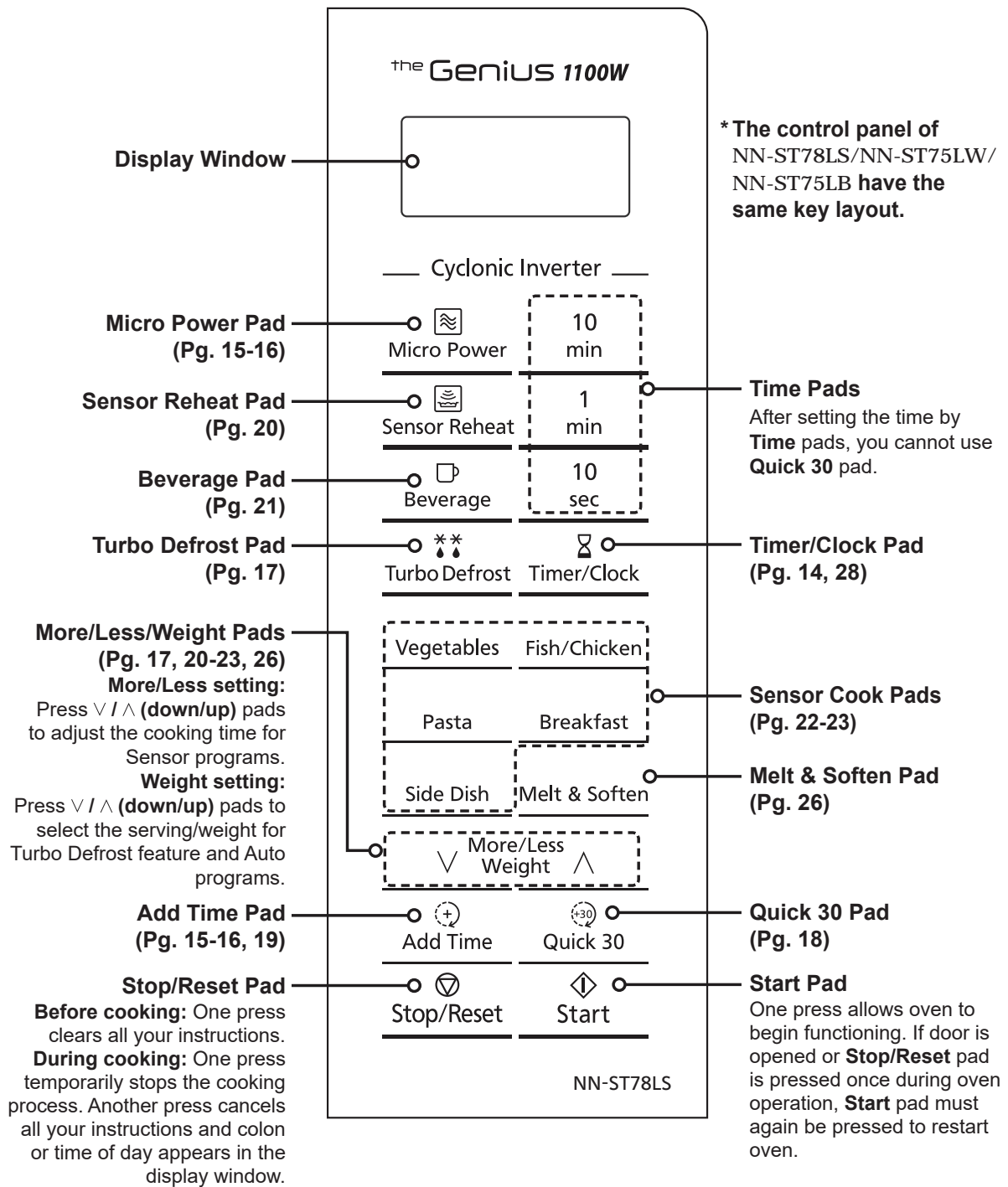

## Note

If an operation is set and **Start** pad is not pressed, after 6 minutes, the oven will automatically cancel the operation. The display will revert back to clock or colon mode.

## Beep Sound

When a pad is pressed correctly, a beep sound will be heard. If a pad is pressed and no beep is heard, the unit does not or cannot accept the instruction. The oven will beep twice between programmed stages. At the end of any complete programme, the oven will beep five times.

# Let's Start To Use Your Oven!

## 1 Plug in.

Plug into a properly earthed electrical outlet. "8888" appears in the display window, then you can start to operate.

## 2 Open Door.

Open the door and place container with food in a dish on Glass Tray in the oven. Then close the door.

## 3 Select Power Level.

e.g. P7

Press **Micro Power** pad 4 times (See page 15 for Micro Power chart).



## 4 Set Time.

e.g. 12 minute 20 seconds

Press **Time** pads.

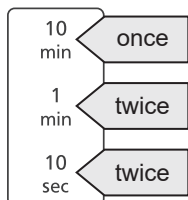

## 5 Press

Cooking will start. The time in the display window will count down.

# Display Window

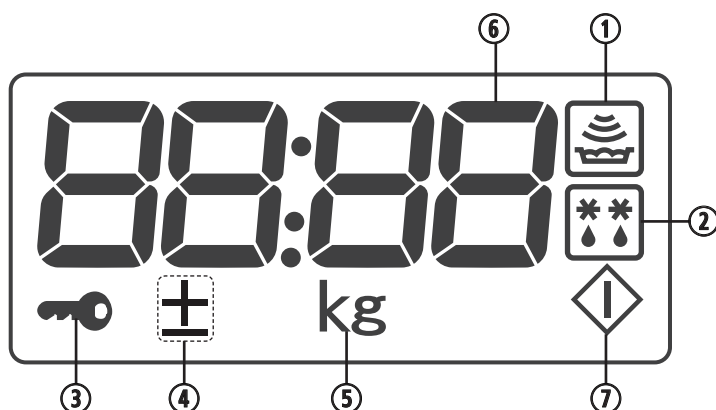

- ① Sensor Feature
- ② Defrost Feature
- ③ Child Safety Lock Setting
- ④ More/Less Feature
- ⑤ Weight (g/kg)
- ⑥ Number (Time/Weight/Menu)
- ⑦ Start



# To Set Clock

You can use the oven without setting the clock.

**1 Press**  **Twice.**

Colon will blink in the display window.

**2 Enter Time of Day.**

e.g. 12:35

Enter time of day by using **Time** pads.

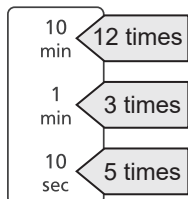

Time appears in the display window, colon is blinking.  
Verify time of day in the display window.

**3 Press** .

Colon stops blinking; time of day is entered and locked in the display window.



## Note

1. To reset time of day, repeat steps 1-3.
2. The clock will keep the time of day as long as oven is plugged in and electricity is supplied.
3. Clock is a 12-hour display.
4. Oven will not operate while colon is blinking.

# To Use Child Safety Lock

This feature allows you to prevent operation of the oven by a young child; however, the door will open.  
**This feature can be set when colon or time of day is displayed.**

**To set:**



**Press Start 3 times.**

Colon or time of day will disappear.

Actual time will not be lost.

"🔒" appears in the display window.

**To cancel:**



**Press Stop/Reset 3 times.**

Colon or time of day will reappear  
in the display window.

To set or cancel child safety lock, **Start** pad or **Stop/Reset** pad must be pressed 3 times within 10 seconds.

# To Cook on Micro Power by Time Setting

## 1 Press to Select Micro Power Level.

Press **Micro Power** pad until your desired power level appears in the display window. **P10** is the highest and **P1** is the lowest. **P0** is the keep warm feature. (see chart below)

Press	Power Level	Wattage	Example Of Use
once	P10 (HIGH)	1100 W	Boil water. Cook vegetables, rice, pasta and noodles. Reheating
twice	P9	1000 W	Cook fresh fruits
3 times	P8	900 W	Cook cakes, desserts. Heat milk
4 times	P7 (MED-HIGH)	800 W	Cook pork, whole chicken and chicken pieces
5 times	P6 (MEDIUM)	700 W	Cook beef, lamb and eggs. Melt butter
6 times	P5	600 W	Cook meatloaves. Melt chocolate
7 times	P4	400 W	Cook fish and seafood
8 times	P3 (MED-LOW)/ DEFROST	300 W	Defrost meat, poultry and seafood
9 times	P2	200 W	Simmer soups, stews and casseroles (less tender cuts)
10 times	P1 (LOW)	100 W	Simmer slowly
11 times	P0 (KEEP WARM)	-	Keep cooked foods warm

## 2 Set Cooking Time.

e.g. 15 minutes

Enter cooking time by using **Time** pads.

**P10(HIGH)** and **P0(KEEP WARM)**: up to 30 minutes, **Other Powers**: up to 99 minutes 50 seconds.

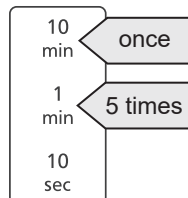

## 3 Press .

Cooking will start.

The time in the display window will count down.



### Note

1. It is possible to programme no more than 3 stages cooking as one cooking set. For 2 or 3 stages cooking, repeat steps 1 and 2 above before pressing **Start** pad. When operating, two beeps will be heard between each stage. (Please refer to page 27 for details).
2. You can increase the cooking time during cooking if required. Time can be increased in 1 minute increments, up to 10 minutes. Press **Add Time** pad once, then press **1 min** pad to a maximum of 10 minutes. After selecting add time feature, time should be added within a 5 second period. Cooking time can not be decreased during cooking.
3. Do not use metal containers on microwave mode.
4. Standing time can be programmed after Micro Power and time setting. Refer to using the timer page 28.

# To Use Keep Warm Feature

This feature will keep cooked food warm for up to 30 minutes after cooking.

**1 Press**  **11 times to Select P0 (KEEP WARM).**

---

## 2 Set Cooking Time.

---

**e.g. 15 minutes**

Enter cooking time by using **Time** pads (up to 30 minutes).

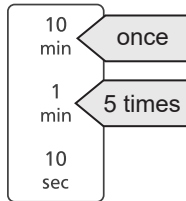

**3 Press** .

---

Cooking will start.  
The time in the display window will count down.



### Note

1. You can increase the cooking time during cooking if required. Time can be increased in 1 minute increments, up to 10 minutes. Press **Add Time** pad once, then press **1 min** pad to a maximum of 10 minutes. After selecting add time feature, time should be added within a 5 second period. Cooking time can not be decreased during cooking.
2. **P0 (KEEP WARM)** can be set as the final stage after cook time has been manually entered. This feature is not available for Turbo Defrost, Beverage, Melt & Soften, Sensor Reheat and Sensor Cook menus.

# To Defrost Using Turbo Defrost

This feature allows you to defrost meat, poultry and seafood automatically by just setting the weight. The serving/weight is 0.1 kg to 3.0 kg.

## 1 Press

Press once to select **Turbo Defrost** feature.

## 2 Select Desired Weight.

Pressing **Turbo Defrost** pad or **More/Less/Weight** pads until your desired weight appears in the display window.



## 3 Press

Defrosting time appears in the display window and begins to count down.

Food	Maximum Weight
Minced meat, chicken pieces, chops	3 kg
Beef roast, lamb, whole chickens	3 kg
Whole fish, scallops, prawns, fish fillets	1 kg

### Tips for Turbo defrost

Meat, which is with bones. For example, if the meat with bones has the same weight as the pure meat, the meat in the former one is lighter than the latter one. So, subtract 0.5 kg for 2 kg meat with bones is better for defrosting and 0.25 kg for meat with bones which is less than 2 kg.

### Two buzz beeps

Turn over the meat, chicken, fish and shellfish. Separate the stewed meat, chicken pieces and meat loaf. Apart the meat loaf from the hamburger. Shield the edge of chicken wings, roast, fat or bones.

### Key to defrosting

For evenly defrosting, turn over the foods or move the position of the foods in the containers during the progress of defrosting.



Remove the package of the raw meat and place it on the plate.



Shield the front part of the chicken drumsticks by using aluminum foil.



Shield the head and tail of the whole fish by using aluminum foil.



Remove the package of the fish fillet and place it on the plate.

# To Cook Using the Quick 30 Feature

This feature allows you to quickly set cooking time in 30 second increments.

**1 Press** .

Press **Quick 30** to set the desired cooking time (up to 5 minutes). Each press is 30 seconds. Time appears in the display. Power level is pre-set at **P10**.

**2 Press** .

The cooking will start and the time in the display will count down. At the end of cooking, five beeps will sound.



## Note

1. This feature is only available for **Micro Power** mode. Select desired micro power level before pressing **Quick 30**.
2. After setting the time by **Quick 30**, you cannot use **Time** pads.



# Using the Add Time Feature

This feature allows you to add cooking time at the end of previous cooking.

**1 Press** .

After cooking, press **Add Time** pad once to select the **Add Time** feature.

## 2 Add Cooking Time.

**e.g. 5 minutes**

Enter cooking time by using **Time** pads.

**P10** and **P0(KEEP WARM)**: up to 30 minutes, **Other powers**: up to 99 minutes and 50 seconds.

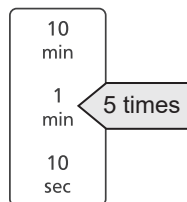

**3 Press** .

Time will be added. The time in the display window will count down.



### Note

1. This feature is not available for Turbo Defrost, Beverage, Melt & Soften, Sensor Reheat and Sensor Cook menus.
2. The Add Time feature will be cancelled if you do not perform any operation for 1 minute after cooking.
3. The Add Time feature can be used after the 3-stage cooking.
4. The power level is the same as the last stage.

# To Use Sensor Reheat Feature

This feature allows you to reheat foods without selecting time and power level. The sensor detects the heat and humidity generated by the food and reheat your food automatically.

**1 Press** .

**2 Press** .

After the heat and humidity is detected by the SENSOR, the remaining time appears in the display window and begins to count down.



## Note

1. If desired, press **More/Less/Weight** pads to adjust the cooking time before pressing **Start**.  
Press "**^**" (**More**) to add 20% more time than suggested.  
Press "**v**" (**Less**) to subtract 20% cooking time.
2. Reheating by Sensor is suitable for pre-cooked foods from refrigerated or room temperature. It is suitable for casseroles, plated meals, soup, stews, pasta dishes (except lasagne) and canned foods. Food being reheated should weigh between 125 g and 1.0 kg. For foods weighing less than 125 g and more than 1.0 kg, use a manual micro power setting.
3. **Do not** reheat bread or pastry products (raw or uncooked), or beverages.
4. **Do not** use if oven cavity is warm (from previously cooked foods).
5. Cover foods securely with plastic wrap. (Do not use any snap closing lids.)
6. The door should not be opened before the time appears in the display window.
7. During the heating time, the oven will 'beep' and prompt you to stir/rearrange the food. There is no need to recover if not required.
8. All foods should have a covered standing time of at least 3 to 5 minutes.

# To Use Beverage Feature

## 1 Press



Press **Beverage** pad until the desired menu appears in the display window (see chart below).

Menu No.	Menu	Serving/Weight		Recommended containers
1	Coffee	1-1 (1 cup coffee)	1-2 (2 cups coffee)	Microwave safe cup
2	Milk	2-1 (1 cup milk)	2-2 (2 cups milk)	

## 2 Select the Serving/Weight.

Select the Serving/Weight by using the **More/Less/Weight** pads.

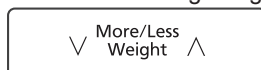

## 3 Press



Reheat will start. The time in the display window will count down.



### Note

1. Use a microwave safe cup. Heated coffee/milk can erupt if not mixed with air. Do not heat coffee/milk in your microwave oven without stirring before and halfway through heating.
2. Care must be exercised not to overheat coffee/milk when using the **Beverage** feature. It is programmed to give proper result when heating 1 cup or 2 cups of coffee/milk, starting from room temperature for coffee and refrigerator temperature for milk. Overheating will cause an increased risk of scalding, or water eruption.
3. 1 cup of milk is 200 ml to 250 ml and 1 cup of coffee is 150 ml to 200 ml.

# To Use Sensor Cook Menus

This feature allows you to cook foods without selecting time and power level. Only set desired menu number, the oven will cook your food automatically.

## 1 Press Desired Food Category Pad.

Select and press the desired food category pad. Menu number will appear in the display window.

e.g. **Vegetables pad**

Vegetables — Press once for Vegetables  
Press twice for Root Vegetables

## 2 Press

After the heat and humidity is detected by the SENSOR, the oven will beep twice, the remaining time appears in the display window and begins to count down.

Press 

Menu No.	Menu	Recommended Weight	Recommended containers
3	Vegetables	125 g - 500 g	Microwave safe dish with lid or plastic wrap
4	Root Vegetables	125 g - 1 kg	
5	Frozen Vegetables	125 g - 1 kg	

Press 

Menu No.	Menu	Recommended Weight	Recommended containers
6	Fish	125 g - 500 g	Microwave safe dish with plastic wrap
7	Chicken Pieces	400 g - 1 kg	Microwave safe casserole with lid or plastic wrap

Press 

Menu No.	Menu	Recommended Weight	Recommended containers
8	Dried Pasta	150 g - 500 g	Microwave dish with lid
9	Instant Noodles	1 serv. - 2 servs.	Microwave casserole with lid

Press 

Menu No.	Menu	Recommended Weight	Recommended containers
10	Porridge	100 g - 300 g	Microwave casserole with lid
11	Scrambled Eggs	50 g - 200 g	Microwave safe dish with plastic wrap

# To Use Sensor Cook Menus (continued)

Press

Side Dish

Menu No.	Menu	Recommended Weight	Recommended containers
12	Legumes	1 cup - 4 cups	Microwave dish with lid
13	Jacket Potatoes	200 g - 900 g	Paper tower
14	Rice	1 cup - 2½ cups	Microwave dish with lid or plastic wrap
15	Risotto	½ cup - 3 cups	Microwave dish with lid
16	Quinoa	¼ cup - 1 cup	Microwave dish with lid or plastic wrap



## Note

1. If desired, press **More/Less/Weight** pads to adjust the cooking time before pressing **Start**. Press "**^**" (**More**) to add 20% more time than suggested. Press "**v**" (**Less**) to subtract 20% cooking time.
2. The door should not be opened before the time appears in the display window.
3. Do not use plastic dishes as a secure seal cannot be achieved and inaccurate cooking may occur.
4. Only cook foods within the weight ranges described and accessories as indicated.
5. To prevent any mistakes during auto sensor programs ensure that the base of the oven and container are dry.
6. To allow for some variations that occur in food, check that food is thoroughly cooked and piping hot before serving.

### 3. Vegetables

It is suitable for cooking all types of leaf, green and soft varieties of vegetables, including broccoli, squash cauliflower, cabbage, asparagus, beans, celery, zucchini, spinach, capsicum or a mixture of these. All vegetables should be trimmed or prepared and cut into evenly sized pieces. Clean the vegetables and place them in a microwave safe container, add 1 tablespoon to ¼ cup of water to vegetables if dehydrated or a softer cooked texture is desired. Butter, herbs, etc., may be added before heating, but do not salt vegetables until serving. Cover dishes securely with lid or plastic wrap and place container at the center of the glass tray. Select the program then press **Start**. Open the door to **STIR WHEN TWO BEEPS HEARD** during cooking, press **Start** pad to continue. At the end of cooking, stir larger quantities of vegetables. Let stand, covered, for 2 to 3 minutes.

### 4. Root Vegetables

Suitable for cooking root vegetables such as potatoes, sweet potatoes, pumpkin, onions, swede, carrots, turnip and beetroot. All vegetables should be trimmed or prepared and cut into even sized pieces. Add 1 tablespoon to ¼ cup of water to vegetables if dehydrated or a softer cooked texture is desired. Place into an appropriate size dish and cover securely with lid or plastic wrap. If desired, butter, herbs etc. may be added but do not add salt until after cooking. Select the program then press **Start**. Open the door to **STIR WHEN TWO BEEPS HEARD** during cooking, press **Start** pad to continue. At the completion of cooking, stir larger quantities of vegetables. Let stand, covered, for 2 to 3 minutes.

### 5. Frozen Vegetables

It is suitable for all types of frozen vegetables. Put them in a microwave safe container. Do not use plastic dishes. Best results are achieved if large quantities are placed in a single layer. Add 1 tablespoon to ¼ cup water to vegetables, if desired. Butter, herbs etc. may be added before heating, but do not add salt until serving. Cover dishes securely with lid or plastic wrap and place container at the center of the glass tray. Select the program then press **Start**. Open the door to **STIR WHEN TWO BEEPS HEARD** during cooking, press **Start** pad to continue. At the end of the cooking, stir vegetables and let stand, covered, for 2 to 3 minutes.

### 6. Fish

It is suitable for cooking whole fish and fish fillets (thickness of fish should not be more than 3 cm). Select fish suitable for microwave cooking and place in a single layer in a shallow microwave safe dish, with skin side down. Add butter, spices, herbs, or lemon juice to flavour. Overlap thin edges of fillets to prevent overcooking. Shield the eye and tail area of whole fish with small amounts of aluminum foil to prevent overcooking. Cover dishes securely with plastic wrap and place container at the center of the glass tray. Select the program then press **Start**. Allow large amounts of fish to stand for 3 to 5 minutes after cooking before serving.



# To Use Sensor Cook Menus (continued)

## 7. Chicken Pieces

It is suitable for cooking chicken pieces, such as wings, thighs, legs, breast fillets. Chicken pieces should be completely thawed before cooking. Pierce the chicken pieces. Marinate chicken pieces before cooking for added flavour and colour. Put the prepared chicken pieces onto a microwave safe dish. Cover securely with lid or plastic wrap and place container at the center of the glass tray. Select the program then press **Start**. Open the door to **TURN OVER WHEN TWO BEEPS HEARD** during cooking, press **Start** Pad to continue. Let stand 5 to 10 minutes at the end of cooking.

## 8. Dried Pasta

It is suitable for cooking a variety of pastas such as spaghetti, fettuccine, tagliatelle, macaroni, penne, spiral and various pasta shapes. Place pasta in an appropriate size microwave safe dish with boiling water. Use the above chart as a guide:

Pasta	150 g	250 g	350 g	500 g
Boiling Water	1 L	1¼ L	1½ L	2 L
Dish Size	3 litre	3 litre	4 litre	4 litre

Always allow at least ½ depth of volume for evaporation to prevent boiling over. Add 1 tablespoon of oil, if desired, before cooking to prevent pasta from sticking together. Cover securely with lid and place container at the center of the glass tray. Select the program then press **Start**. Open the door to **STIR AND REMOVE THE LID WHEN TWO BEEPS HEARD** during cooking, press **Start** pad to continue. At the end of the cooking, cover and let stand for 5 to 10 minutes, if required, before draining.

## 9. Instant Noodles

It is suitable for cooking instant noodles. Place the instant noodles and seasoning in a suitable size microwave safe casserole with boiling water. Use the above chart as a guide:

Instant Noodle	1 Serv.	2 Servs.
Boiling Water	500 ml	800 ml
Dish Size	3 litre	4 litre

Allow at least ½ depth of volume for evaporation to prevent boiling over. Cover securely with lid and place container at the center of the glass tray. Select the program then press **Start**. Open the door to **STIR WHEN TWO BEEPS HEARD** during cooking, press **Start** pad to continue.

## 10. Porridge

Porridge	Recommended Water	Recommended Containers
100 g	750 ml	2¼ L
200 g	1100 ml	3 L
300 g	1700 ml	4 L

It is suitable for cooking congee/porridge. Place the rice in a suitable size microwave safe casserole. Add recommended water listed below. Allow at least ½ depth of volume for evaporation to prevent boiling over. Partially cover with lid. Select the program then press **Start**. Open the door to **STIR WHEN TWO BEEPS HEARD** during cooking, press **Start** pad to continue. Stand 5 to 10 minutes covered after cooking.

## 11. Scrambled Eggs

Egg	50 g	100 g	150 g	200 g
Butter	10 g	10 g	20 g	20 g
Milk	40 ml	80 ml	120 ml	160 ml
Dish Size	2 litre	2 litre	3 litre	3 litre

Melt butter in microwave safe dish at **P10** for 20 seconds or until melted. Turn the dish to coat the bottom with butter. Meanwhile, combine egg and milk (add pinch of salt) in a separate bowl, beat together, and pour into the dish. Cover dish with plastic wrap and place container at the center of the glass tray. Select the program then press **Start**. Open the door to **STIR AND REMOVE THE PLASTIC WRAP WHEN TWO BEEPS HEARD** during cooking, press **Start** pad to continue.

## 12. Legumes

It is suitable for cooking chickpeas, split peas dried beans and peas. Cover legumes with cold water and soak overnight, drain. Place legumes and boiling water into an appropriate sized microwave safe container. (See table for quantities)

Legumes	1 cup	2 cups	3 cups	4 cups
Boiling Water	750 ml	1 L	1½ L	2 L
Dish Size	3.5 litre	3.5 litre	4 litre	4.5 litre

Cover dishes securely with lid and place container at the center of the glass tray. Select the program then press **Start**. Open the door to **STIR WHEN TWO BEEPS HEARD** during cooking, press **Start** pad to continue. At the end of cooking, allow legumes to stand for 5 minutes if required. If food needs more time cooking, cook using **P6**.

## To Use Sensor Cook Menus (continued)

### 13. Jacket Potatoes

Suitable for cooking whole potatoes with their skin left on. Choose medium sized potatoes weighing approximately 200-250 g each. Wash and scrub potatoes and dry well. Prick with a fork several times. Place on glass tray lined with paper towel. Select the program then press **Start**. Open the door to **TURN OVER WHEN TWO BEEPS HEARD** during cooking, press **Start** pad to continue. At the end of cooking time, allow the potato to stand for 5 to 10 minutes.

### 14. Rice

It is suitable for cooking short and long grain rice including specialty rice. It is not suitable for cooking brown rice or wild rice. Place rice with water at room temperature in a suitable microwave safe dish. We recommend the following proportions of rice to cold tap water:

Rice	1 cup	1½ cups	2 cups	2½ cups
Water	375 ml	625 ml	875 ml	1⅛ L
Dish Size	3 litre	3 litre	4.5 litre	4.5 litre

It may be necessary to adjust the water to your personal preference. Soak in water for 10 to 15 minutes. Always allow at most ½ depth of volume for evaporation to prevent boiling over. Do not cook rice in plastic dishes as incorrect cooking times may result. Cover securely with plastic wrap and place container at the center of the glass tray. Select the program then press **Start**. Open the door to **STIR AND REMOVE THE PLASTIC WRAP WHEN TWO BEEPS HEARD** during cooking, press **Start** pad to continue.

### 15. Risotto\*

It is suitable for cooking many basic risotto recipes and variations. Onions and garlic should be pre-cooked with 1 tablespoon of oil before adding rice and stock. The quantities of rice and amounts of stock, please follow the chart below. Always use arborio rice or short grain rice. Chicken, vegetable, beef or fish stock may be used. Stock should be boiling when added to rice otherwise cooking times may be incorrect. Cover dish securely with lid at stage 1. Select the program then press **Start**. Open the door to **STIR WHEN TWO BEEPS HEARD** during cooking. Remove the lid completely from dish. Add remaining stock. There is no need to re-cover for stage 2. At the end of stage 2 add grated parmesan cheese, stir through and cook for 2 to 4 minutes on **P10**. Standing time may be required at the end to allow risotto to finish cooking.

### 16. Quinoa

It is suitable for cooking quinoa. Place quinoa in a microwave safe casserole dish. Use the above chart as a guide:

Quinoa	¼ cup	½ cup	¾ cup	1 cup
Tap water	190 ml	250 ml	375 ml	500 ml
Dish Size	2 litre	2.5 litre	3 litre	3.5 litre

Allow at least ½ depth of volume for evaporation to prevent boiling over. Soak in water for 10 to 15 minutes. Cover securely with lid or plastic wrap and place container at the center of the glass tray. Select the program then press **Start**. Open the door to **STIR WHEN TWO BEEPS HEARD** during cooking, press **Start** pad to continue. At the end of the cooking, let stand 10 to 15 minutes.

### \* General Quantities For Cooking Risotto

	Preparation (Manual Setting) High for 1 to 2 min. (all quantities)	Sensor Cook		Finish (Manual Setting) High for 2 to 4 min.	
		Stage 1	Stage 2		
½ cup	½ onion 1 clove garlic 1 tablespoon oil	Rice ½ cup	Boiling Stock 200 ml	Boiling Stock 200 ml	2 tablespoons parmesan
1 cup	1 onion 1 clove garlic 1 tablespoon oil	1 cup	400 ml	400 ml	2 tablespoons parmesan
2 cups	1 onions 2 cloves garlic 2 tablespoons oil	2 cups	650 ml	650 ml	¼ cup parmesan
3 cups	2 onions 3 cloves garlic 3 tablespoons oil	3 cups	850 ml	850 ml	½ cup parmesan

# To Use Melt & Soften Feature

## 1 Press .

Press **Melt & Soften** pad until the desired menu appears in the display window (see chart below).

Menu No.	Menu	Serving/Weight						Recommended containers
		50 g	100 g	150 g	200 g	250 g	300 g	
17	Cream Cheese	50 g	100 g	150 g	200 g	250 g	300 g	Microwave safe bowl/dish with plastic wrap
18	Chocolate	50 g	100 g	150 g	200 g	250 g	300 g	Microwave safe dish
19	Butter	50 g	100 g	150 g	200 g	250 g	300 g	Microwave safe dish with plastic wrap
20	Ice Cream	200 g	500 g	1000 g	2000 g	-	-	-

## 2 Select the Serving/Weight.

Select the Serving/Weight by using the **More/Less/Weight** pads.

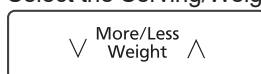

## 3 Press .

Reheat will start. The time in the display window will count down.

### For best results on Melt & Soften, follow these recommendations:

#### ■ Cream Cheese:

Remove wrapper and place in a microwave safe bowl/dish. Soften with plastic wrap.

#### ■ Chocolate:

Remove wrapper and place chocolate into a microwave safe dish. Cook without cover. Open the door to **STIR WHEN TWO BEEPS HEARD** during cooking, press **Start** pad to continue. After heating, stir until completely melted.

**Note:** Chocolate holds its shape even when softened.

#### ■ Butter:

Remove wrapper, cut butter into 3 cm cubes, and place into a microwave safe dish. Melt with plastic wrap. Stir after cooking.

#### ■ Ice Cream:

Soften slightly without lid.



### Note

If food needs more time cooking or weight exceeds range, cook using **P3** for melting or softening.

## 3-Stage Setting

This feature allows you to program 3 Stages of cooking continuously.

**E.g.: Continually set [P10] 2 minutes, [P6] 3 minutes and [P1] 2 minutes.**

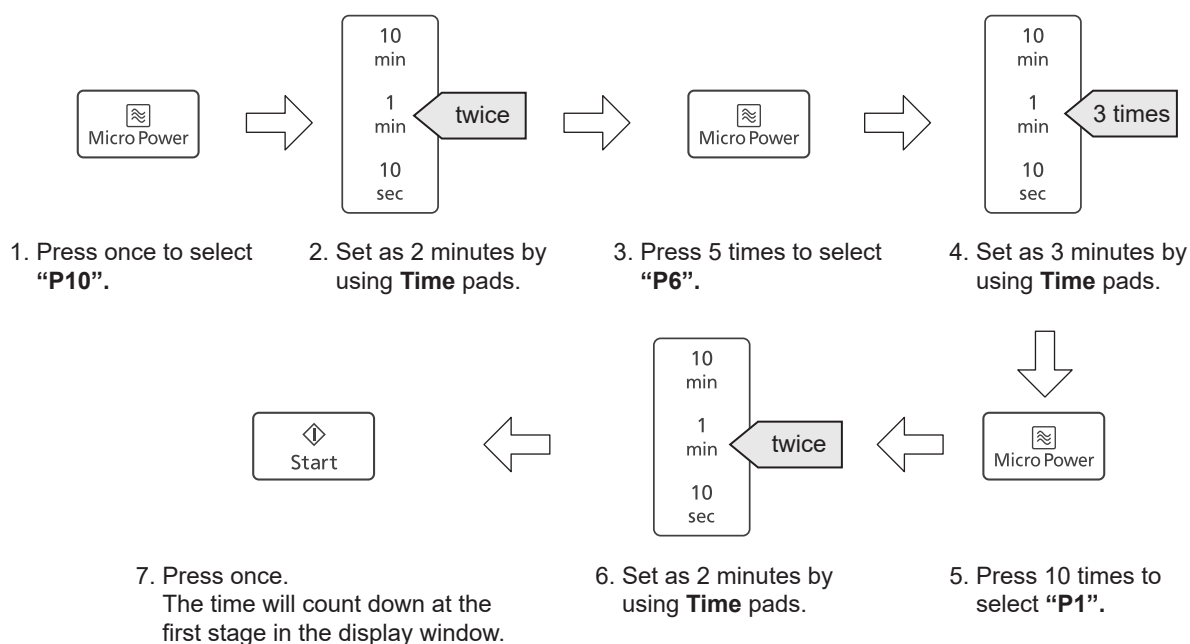

### Note

1. When operating, two beeps will sound between each stage.
2. This feature is not available for Turbo Defrost, Beverage, Melt & Soften, Sensor Reheat and Sensor Cook menus.

## Ingredient Conversion Chart

Ingredient Conversion Chart			
¼ cup	60 ml	¼ teaspoon	1 ml
⅓ cup	85 ml	½ teaspoon	2 ml
½ cup	125 ml	1 teaspoon	5 ml
⅔ cup	165 ml	2 teaspoons	10 ml
¾ cup	190 ml	3 teaspoons	15 ml
1 cup	250 ml	1 tablespoon	20 ml
1¼ cups	310 ml	1½ tablespoons	30 ml
1½ cups	375 ml	2 tablespoons	40 ml
2 cups	500 ml	3 tablespoons	60 ml
3 cups	750 ml	4 tablespoons	80 ml
3½ cups	875 ml		
4 cups	1 L		
6 cups	1½ L		
8 cups	1½ L		

All recipes are tested using standard measurement that appear in the above chart.

# To Use Timer

This feature allows you to program standing after cooking is completed and to program the oven as a minute or a second timer or program delay start.

## To Use as a Kitchen Timer

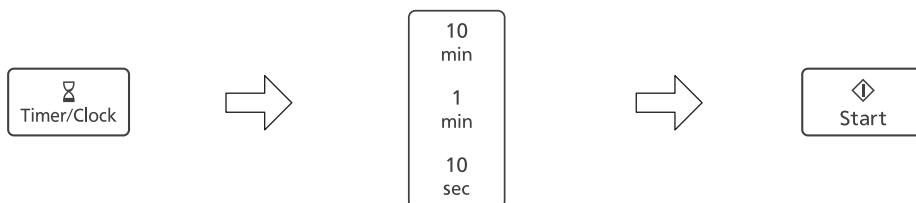

**1. Press once.**

**2. Set desired amount of time.**  
(up to 99 minutes and 50 seconds)

**3. Press Start.**  
Time will count down without oven operating.

## To Set Standing Time

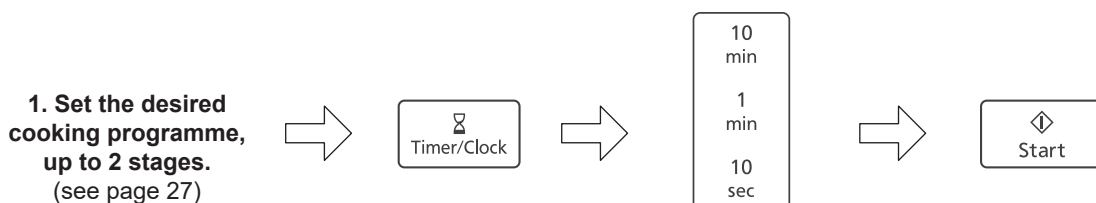

**1. Set the desired cooking programme, up to 2 stages.**  
(see page 27)

**2. Press once.**

**3. Set desired amount of standing time.**  
(up to 99 minutes and 50 seconds)

**4. Press Start.**  
Cooking will start. After cooking, standing time will count down without oven operating.

## To Set Delay Start

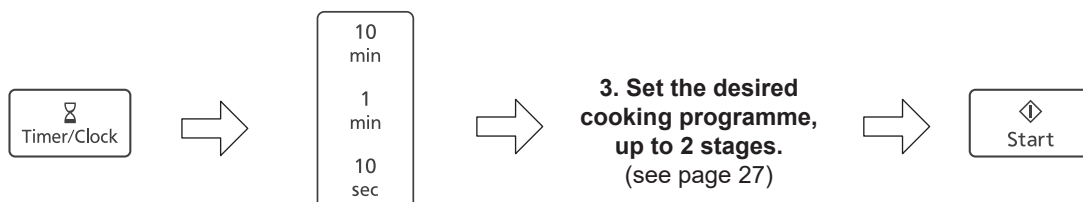

**1. Press once.**

**2. Set desired amount of delay time.**  
(up to 99 minutes and 50 seconds)

**3. Set the desired cooking programme, up to 2 stages.**  
(see page 27)

**4. Press Start.**  
Delayed time will count down without oven operating. Then cooking will start.



### Note

1. If oven door is opened during the Standing Time, Delay Start or Kitchen Timer, the time in the display window will continue to count down.
2. Delay Start and Standing Time cannot be programmed together with Turbo Defrost, Beverage, Melt & Soften, Sensor Reheat and Sensor Cook menus. This is to prevent the standing temperature of the food from rising before defrosting or cooking begins. A change in the starting temperature could cause inaccurate results.
3. When using Standing Time or Delay Start, it's up to 2 power stages.



# Defrosting Chart

The times given below are a guideline only. Always check the progress of the food by opening the oven door and then re-starting. For larger quantities adjust times accordingly. Food should not be covered during defrosting.

Food	Weight/Quantity	Time & Mode	Method
Beef/Lamb/Joint (1)(3)	450 g	P3 6-8 mins	standing 30 mins
Steaks (1)(3)	2 pcs 250 g	P3 3-4 mins	standing 3 mins
Minced beef (1)(3)	450 g	P3 6-7 mins	standing 5 mins
Stewing steak (1)(3)	450 g	P3 6-8 mins	standing 10 mins
Whole chicken (1)(3)	450 g	P3 5-7 mins	standing 10 mins
Chicken portions (1)(3)	450 g	P3 6-8 mins	standing 5 mins
Whole fish (1)(3)	450 g	P3 6-8 mins	standing 5 mins
Fish fillets (2)(3)	450 g	P3 5-7 mins	standing 5 mins
Prawns (2)(3)	450 g	P3 4-6 mins	standing 5 mins
Fruits, soft (1)	250 g	P3 2-3 mins	standing 2 mins
Margarine (3)	250 g	P3 1-2 mins	standing 2 mins
Cheese (3)	450 g	P3 2-4 mins	standing 2 mins
Plated meals homemade adult size (2)	350 g	P3 5-6 mins	standing 3-5 mins
Cooked Fruit (2)	540 g	P3 4-5 mins	standing 3-5 mins
Cooked meat (2)	520 g	P3 6-8 mins	standing 3-5 mins
Quiche (3)	1 pc 65 g	P3 1-2 mins	standing 2 mins
Casseroles (1)	750 g	P3 6-7 mins	standing 3-5 mins
Bread rolls (1)	1 pc 85 g	P3 20-30 secs	standing 5 mins
Pastry puff (1)(3)	1 roll 375 g	P3 2 mins-2 mins 30 secs	Stand time 20 mins in refrigerator
Pastry shortcrust (1)(3)	1 roll 500 g	P3 4-5 mins	Stand time 20 mins in refrigerator
Pizza dough (1)(3)	1 ball 240 g	P3 2 mins-2 mins 30 secs	standing 10 mins
Fruit tarte (3)	470 g	P3 4-5 mins	standing 5 mins
Cheese cake (3)	600 g	P3 2-3 mins	standing 5 mins
Fruit pie (3)	500 g	P3 6-8 mins	standing 5 mins
Meat pie (3)	300 g	P3 4-6 mins	standing 3 mins

(1) Turn or stir at half time.

(2) Separate and turn several times.

(3) Remove packaging and place on a heat resistant plate.

# Reheating Chart

The times given in the charts below are a guideline only, and will vary depending on starting temperature, dish size etc.

Food	Weight/ Quantity	Time & Mode	Method
<b>Drinks-Coffee-Milk</b>			
Coffee	1 mug 235 ml	P10 1 min 10 secs	Stir before, and after reheating.
Coffee	2 mugs 470 ml	P10 2 mins 20 secs- 2 mins 30 secs	
Milk	1 mug 235 ml	P10 1 min 20 secs- 1 min 30 secs	
<b>Breads-chilled</b>			
Croissants	1 pc 40 g	P10 10 secs	Place on microwave safe plate on Glass Tray. Do not cover. Turn at half time.
	2 pcs 80 g	P10 20 secs	
Rolls	1 pc 30 g	P10 20 secs	
	4 pcs 120 g	P10 20-30 secs	
Naan bread	225 g	P10 30-40 secs	
Pitta bread	2 pcs 90 g	P10 20-30 secs	
<b>Plated meals-Homemade</b>			
Vegetables (cooked)	300 g	P10 2 mins	Cover. Stir at half time.
	700 g	P10 5 mins-5 mins 30 secs	
Potato puree	500 g	P10 3-4 mins	
Rice, quinoa, couscous	300 g	P10 2 mins-2 mins 20 secs	
Babyfood	120 g	P6 30-40 secs	
<b>Canned Food</b>			
Baked beans	225 g	P10 1 min 30 secs-2 mins	Place in a microwave safe bowl on Glass Tray. Cover. Stir halfway.
Spaghetti in tomato sauce	200 g	P10 1 min 30 secs	
Cream of tomato soup	400 g	P10 2 mins 30 secs	
Chicken soup	425 g	P10 3 mins	
<b>Pastry Products-frozen</b>			
Quiche	400 g	P10 2-3 mins	Place on microwave safe plate on Glass Tray. Do not cover.
Samosas/spring rolls	4 pcs 240 g	P10 1-1 min 30 secs	
<b>Purchased Convenience Foods</b>			
Cottage pie (chilled)	450 g	P10 5-6 mins	Place on microwave safe plate on Glass Tray. Do not cover.
Lasagne (chilled)	400 g	P10 7-8 mins	
Sausage rolls	250 g	P6 3-5 mins	

# Cooking Chart

Food	Weight/Quantity	Time & Mode	Method
<b>Beans &amp; Pulses-should be pre-soaked (except lentils)</b>			
Chick peas	225 g	P10 8 mins then P4 35-40 mins	Use 1 L boiling water in a large bowl. Cover. Stir halfway.
Lentils	225 g	P4 35-40 mins	
Red kidney beans	225 g	P10 12-14 mins then P4 35-40 mins	
<b>Fruit-Peel, slice, chop into even sized pieces. Place in shallow microwave safe dish.</b>			
Apples, Rhubarb, stewed	450 g	P10 5-6 mins	Add 30 ml of water. Only half fill dish. Cover. Stir halfway.
Plums-stewed	450 g	P10 7-8 mins	
<b>Lamb/Beef-from raw-Caution: Hot Fat! Remove dish with care.</b>			
Chops	450 g	P8 4-5 mins then P6 3-4 mins	Place on heatproof plate. Turn halfway.
Cultets	450 g	P6 9-10 mins	
<b>Pasta-Place in a large 3-litre (6 pints) microwave safe bowl</b>			
Macaroni	225 g	P10 11-13 mins	Use 1 L boiling water. Cover. Stir halfway.
Spaghetti, Tagliatellie	225 g	P10 10-12 mins	
<b>Pizza-Fresh chilled- N.B. Remove all packaging. Pizza will have a soft base.</b>			
Thin & Crispy	300 g	P10 2-3 mins	Place on heatproof plate on Glass Tray. Do not cover.
Deep pan	400 g	P10 3-5 mins	
<b>Fish &amp; Shellfish</b>			
Whole fish	350 g	P6 7-8 mins	Place on heatproof dish. Turn or stir halfway.
Sea scallops	450 g	P6 8-10 mins	
Green prawns	250 g	P6 4-5 mins	
<b>Sausages-cooked (frozen)-Caution: Hot Fat! Remove dish with care.</b>			
Thick	4 pcs 240 g	P10 2-3 mins	Place on microwave safe plate on Glass Tray. Turn halfway.
Thin	4 pcs 120 g	P10 1 min 30 secs- 2 mins 30 secs	



## Note

Always check that food is piping hot after reheating in the microwave. If unsure, return to oven. Foods will still require a stand time, especially if they cannot be stirred. The denser the food the longer the stand time.

# Before Requesting Service

## THESE THINGS ARE NORMAL

The oven causes interference with my TV.

Some radio, TV, Wi-Fi, cordless telephone, baby monitor, blue tooth or other wireless equipment interference might occur when you cook with the microwave oven. This interference is similar to the interference caused by small appliances such as mixers, vacuums, blow dryers, etc. It does not indicate a problem with your oven.

Steam accumulates on the oven door and warm air comes from the oven vents.

During cooking, steam and warm air are given off from the food. Most of the steam and warm air are removed from the oven by the air which circulates in the oven cavity. However, some steam will condense on cooler surfaces such as the oven door. This is normal.

I accidentally ran my microwave oven without any food in it.

Running the oven empty for a short time will not damage the oven. However, we do not recommend this.

PROBLEM	POSSIBLE CAUSE	REMEDY
Oven will not turn on.	The oven is not plugged in securely.	Remove plug from outlet, wait 10 seconds and re-insert.
	Circuit breaker or fuse is tripped or blown.	Reset circuit breaker or replace fuse.
	There is a problem with the outlet.	Plug another appliance into the outlet to check if the outlet is working.
Oven will not start cooking.	The door is not closed completely.	Close the oven door securely.
	<b>Start</b> pad was not pressed after programming.	Press <b>Start</b> pad.
	Another program has already been entered into the oven.	Press <b>Stop/Reset</b> pad to cancel the previous program and program again.
	The program has not been entered correctly.	Program again according to the Operating Instructions.
	<b>Stop/Reset</b> pad has been pressed accidentally.	Program oven again.
When the oven is turning on, there is noise coming from Glass Tray.	The Roller Ring and oven bottom are dirty.	Clean these parts according to care of your oven (See next page).
"🔒" appears in the display window.	The Child Lock was activated by pressing <b>Start</b> pad 3 times.	Deactivate Lock by pressing <b>Stop/Reset</b> pad 3 times.
"H97", "H98" or "H00" appears in the Display Window.	The display indicates a problem with microwave generation system.	Contact the specified service centre.

If it seems there is a problem with the oven, contact an authorized Service Centre.

# Care of your Microwave Oven

Turn the oven off and remove the power plug from the wall socket before cleaning.

Keep the inside of the oven clean. When food splatters or spilled liquids adhere to oven walls, wipe with a damp cloth. Mild detergent may be used if the oven gets very dirty. The use of harsh detergent or abrasives is not recommended.

It is occasionally necessary to remove the Glass Tray for cleaning. Wash the tray in warm sudsy water or in a dishwasher.

The outside oven surfaces should be cleaned with a damp cloth. To prevent damage to the operating parts inside the oven, water should not be allowed to seep into the ventilation openings.

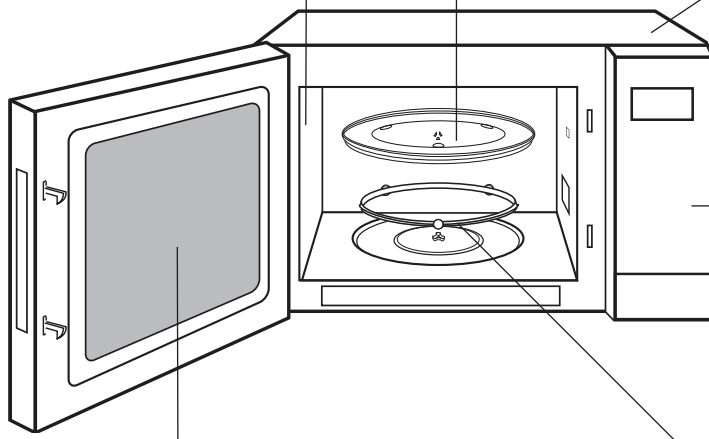

Do not allow the Control Panel to become wet. Clean with a soft, damp cloth. Do not use detergents, abrasives or spray-on cleaners on the Control Panel. When cleaning the Control Panel, leave oven door open to prevent oven from accidentally turning on. After cleaning press **Stop/Reset** pad to clear display window.

If steam accumulates inside or around the outside of the oven door, wipe with a soft cloth. This may occur when the microwave oven is operated under high humidity conditions and in no way indicates malfunction of the unit.

The Roller Ring and oven cavity floor should be cleaned regularly to avoid excessive noise. Simply wipe the bottom surface of the oven with mild detergent, water or window cleaner and dry. The Roller Ring may be washed in mild sudsy water or dish washer. Cooking vapors collect during repeated use but in no way affect the bottom surface or Roller Ring wheels. When removing the Roller Ring from cavity floor for cleaning, be sure to replace in the proper position.



## Note

1. When it becomes necessary to replace the oven light, please consult a dealer to have it replaced.
2. The oven should be cleaned regularly and any food deposits removed.
3. Do not use harsh abrasive cleaners or sharp metal scrapers to clean the oven door glass, since they can scratch the surface, which may result in shattering of the glass.
4. A steam cleaner is not to be used for cleaning.

# Technical Specifications

Model	NN-ST75LW	NN-ST75LB	NN-ST78LS
Power Supply:	230 - 240 V, 50 Hz		
Power Consumption*:	4.4 A 1,000 W		
Power Requirement: (Maximum)	7.5 A 1,800 W		
Operating Frequency:	2,450 MHz		
Output*:	1,100 W		
Outside Dimensions (W x H x D):	555 mm (W) x 304 mm (H) x 493 mm (D)		
Oven Cavity Dimensions (W x H x D):	398 mm (W) x 210 mm (H) x 470 mm (D)		
Overall Cavity Volume:	44 L		
Glass Tray Diameter:	Ø380 mm		
Uncrated Weight:	Approx. 14.3 kg		

## Trim Kit

Model Name	NN-ST78LS
Model Number	NN-TK712SSQP
Outside Dimensions	596 mm (W) x 410 mm (H)
Cabinet Opening	600 mm (W) x 395 mm (H) x 533 mm (D)

\* IEC Test Procedure

Specifications subject to change without notice.

As for the voltage requirement, the production month, country and serial number, please refer to the identification plate on the microwave oven.



# Panasonic Warranty (For Australia)

## Home Appliance 12 Month Warranty from Date of Purchase

1. Subject to the conditions of this warranty Panasonic or its Authorised Service Centre will perform necessary service on the product without charge for parts or labour, if in the opinion of Panasonic, the product is found to be faulty within the warranty period. For Communications products (i.e. Cordless Phones, etc) the genuine battery(s) has a 3 month warranty.
2. This warranty only applies to Panasonic products purchased in Australia and sold by Panasonic Australia or its Authorised Distributors or Dealers and only where the products are used and serviced within Australia or its territories. Warranties cover only applies to service carried out by a Panasonic Authorised Service Centre and only if valid proof of purchase is presented when warranty service is requested.
3. This warranty only applies if the product has been installed and used in accordance with the manufacturer's recommendations (as noted in the operating instructions) under normal use and reasonable care (in the opinion of Panasonic). The warranty covers normal domestic use only (also Clip & Trim Professional use) and does not cover damage, malfunction or failure resulting from use of incorrect voltages, incorrect installation, accident, misuse, neglect, build-up of dirt or dust, abuse, maladjustment of customer controls, mains supply problems, thunderstorm activity, infestation by insects or vermin, tampering or repair by unauthorised persons (including unauthorised alterations), exposure to abnormally corrosive conditions or any foreign object or matter having entered the product.
4. This warranty does not cover the following items unless the fault or defect existed at the time of purchase:
  - (a) Cabinet Parts
  - (b) Microwave Oven Plates.
  - (c) User replaceable Batteries
  - (d) Kneader Mounting Shaft, Shaver Heads, Cutters, Foils, Blades
  - (e) Accessories
  - (f) Noise or vibration that is considered normal
5. To claim warranty service, when required, you should:
  - Contact Panasonic's Customer Care Centre on 132600
  - Send or take the product to a Panasonic Authorised Service Centre together with your purchase receipt as a proof of purchase date. Please note that freight and insurance to and / or from your nearest Authorised Service Centre must be arranged by you.
6. The warranties hereby conferred do not extend to, and exclude, any costs associated with the installation, de-installation or re-installation of a product, including costs related to the mounting, de-mounting or remounting of any screen, (and any other ancillary activities), delivery, handling, freighting, transportation or insurance of the product or any part thereof or replacement of and do not extend to, and exclude, any damage or loss occurring by reason of, during, associated with, or related to such installation, de-installation, re-installation or transit.

Panasonic Authorised Service Centres are located in major metropolitan areas and most regional centres of Australia, however, coverage will vary dependant on product. For advice on exact Authorised Service Centre locations for your product, please telephone our Customer Care Centre on 132600.

In addition to your rights under this warranty, Panasonic products come with consumer guarantees that cannot be excluded under the Australian Consumer Law. If there is a major failure with the product, you can reject the product and elect to have a refund or to have the product replaced or if you wish you may elect to keep the goods and be compensated for the drop in value of the goods. You are also entitled to have the product repaired or replaced if the product fails to be of acceptable quality and the failure does not amount to a major failure.

If there is a major failure in regard to the product which cannot be remedied then you must notify us within a reasonable period by contacting the Panasonic Customer Care Centre. If the failure in the product is not a major failure then Panasonic may choose to repair or replace the product and will do so in a reasonable period of time from receiving notice from you.

**THIS WARRANTY CARD AND THE PURCHASE DOCKET (OR SIMILAR PROOF OF PURCHASE)  
SHOULD BE RETAINED BY THE CUSTOMER AT ALL TIMES**

If you require assistance regarding warranty conditions or any other enquiries, please visit the **Panasonic Australia** website [www.panasonic.com.au](http://www.panasonic.com.au) or contact by phone on **132 600**  
*If phoning in, please ensure you have your operating instructions available.*

**Panasonic Australia Pty. Limited**

ACN 001 592 187 ABN 83 001 592 187

1 Innovation Road, Macquarie Park NSW 2113  
[www.panasonic.com.au](http://www.panasonic.com.au)

PRO-031-F01 Issue: 6.0

02-10-2013

# Panasonic Warranty (For New Zealand)

## Built In Kitchen Appliance 24 Month from Date of Purchase Home Appliance 24 Month Warranty from Date of Purchase

1. Subject to the conditions of this warranty Panasonic or its Authorised Service Centre will perform necessary service on the product without charge for parts or labour, if in the opinion of Panasonic, the product is found to be faulty within the warranty period. For Line Communications products (i.e. Cordless Phones, etc.) the genuine battery(s) has a 3 month warranty.
2. This warranty only applies to Panasonic products purchased in New Zealand and sold by Panasonic New Zealand or its authorised Distributors or Dealers and only where the products are used and serviced within New Zealand or its territories. Warranty cover only applies to service carried out by a Panasonic Authorised Service and only if valid proof of purchase is presented when warranty service is requested.
3. This warranty only applies if the product has been installed and used in accordance with the manufacturer's recommendations (as noted in the operating instructions) under normal use and reasonable care (in the opinion of Panasonic). The warranty covers normal domestic use only (also Clip & Trim Professional use) and does not cover damage, malfunction or failure resulting from use of incorrect voltages, incorrect installation, accident, misuse, neglect, build-up of dirt or dust, abuse, maladjustment of customer controls, mains supply problems, thunderstorm activity, infestation by insects or vermin, tampering or repair by unauthorised persons (including unauthorised alterations), exposure to abnormally corrosive conditions or any foreign object or matter having entered the product.
4. This warranty does not cover the following items unless the fault or defect existed at the time of purchase:
  - (a) Cabinet Parts
  - (b) Microwave Oven cook plates
  - (c) User replaceable Batteries from wear and tear in normal use
  - (d) Kneader mounting shaft unit and Heads, Cutters, Foils, Blades and other accessories
  - (e) Noise or vibration that is considered normal
  - (f) Correcting the installation (e.g. removal of transit bolts, levelling and locking feet)
  - (g) Damage caused by water pressure exceeding 1MPa
  - (h) Water on floor due to incorrect loading, excessive suds, foreign matter on door seals
  - (i) Blocked pumps and removal filters, removal of foreign objects from the machine (e.g. bra wires, bread tags, nails, screws, coins, grit etc.)
  - (j) Replaceable lint filters
  - (k) Damage to surfaces caused by liquid or solid spillages, impact or lack of maintenance & cleaning products other than that recommended in the operating instructions
  - (l) Consumables (light bulbs, filters)
5. To claim warranty service, when required, you should:
  - Telephone Panasonic's Customer Care Centre on 09 272 0178 or visit our website referred to below and use the Service Centre Locator for the name/address of the nearest Authorised Service Centre.
  - Send or take the product to a Panasonic Authorised Service Centre together with your proof of purchase receipt as a proof of purchase date. Please note that freight and insurance to and / or from your nearest Authorised Service Centre must be arranged by you.
6. The warranties hereby conferred do not extend to, and exclude, any costs associated with the installation, de-installation or re-installation of a product, including costs related to the mounting, de-mounting or remounting of any screen, (and any other ancillary activities), delivery, handling, freighting, transportation, or insurance of the product or any part thereof or replacement of and do not extend to, and exclude, any damage or loss occurring by any reason of, during, associated with, or related to such installation, de-installation, re-installation or transit.

Panasonic Authorised Service Centres are located in major metropolitan areas and most regional centres of New Zealand, however, coverage will vary dependant on product. For advice on exact Authorised Service Centre locations for your product, please telephone our customer Care Centre on 09 272 0178 or visit our website and use the Service Centre locator.

Unless otherwise specified to the consumer the benefits conferred by this express warranty are additional to all other conditions, warranties, guarantees, rights and remedies expressed or implied by the Consumer Guarantees Act of New Zealand and all other obligations and liabilities on the part of the manufacturer or supplier and nothing contained herein shall restrict or modify such rights, remedies, obligations and liabilities.

**THIS WARRANTY CARD AND THE PURCHASE DOCKET (OR SIMILAR PROOF OF PURCHASE)  
SHOULD BE RETAINED BY THE CUSTOMER AT ALL TIMES**

If you require assistance regarding warranty conditions or any other enquiries, please visit the **Panasonic New Zealand** website [www.panasonic.co.nz](http://www.panasonic.co.nz) or contact by phone on **09 272 0178**  
*If phoning in, please ensure you have your operating instructions available.*

### PANASONIC NEW ZEALAND CUSTOMER CARE CENTRE

Phone: 09 272 0178

Email: [customerservice@nz.panasonic.com](mailto:customerservice@nz.panasonic.com)

Fax: 09 272 0129

Website: [www.panasonic.co.nz/support](http://www.panasonic.co.nz/support)

Microwaves penetrate the surface of the food to a depth of about two to three centimetres and then the heat is gradually conducted in a random pattern. Some parts of food matter cook faster than others. Special microwave techniques are used to promote

fast and even cooking. Some of these techniques are similar to those used in conventional cooking, but because microwaves produce heat very quickly the following techniques are extremely important. It's a must for you to be familiar with the following tips.

---

## Food Characteristics

---

### Size and Quantity

Small portions cook faster than large portions. As you increase the quantity of food you put into the microwave oven, you must also increase your cooking time. The microwave oven has the same power regardless of quantity; thus the power is divided between more items and so it takes longer to cook. As a general guide, if you double the quantity of food suggested in the recipe, add half the time suggested again.

### Liquid Content

Low moisture foods take a shorter time to cook than foods with a lot of moisture.

### Shape

Uniform sizes cook more evenly. To compensate for irregular shapes, place thin pieces towards the centre of the dish and thicker pieces towards the outer edge of the dish.

### Bone and Fat

Bones conduct heat and cause the meat next to them to be heated more quickly. Large amounts of fat absorb microwave energy and the meat next to these areas may overcook.

### Starting Temperature

Food which has been sitting at room temperature takes less time to cook than refrigerated or frozen food.

### Density and Composition

Porous, airy foods (cakes and breads) take less time to cook than heavy compacted foods (meat and vegetables). Recipes high in fat and sugar content cook more quickly.

### Soups

Use a bowl and stir before heating and at least once through reheat time and again at the end.

---

## Techniques for Preparation

---

### Timing

A range of cooking times is given in each recipe for two reasons. First, to allow for the uncontrollable differences in food shapes, starting temperatures and personal preferences. Secondly, these allow for the differences in electrical voltage input which changes during peak load periods. Always remember that it is easier to add time to undercooked food. Once the food is overcooked, nothing can be done. For each recipe, an approximate cooking time is given.

### Stirring

Stirring is often necessary during microwave cooking. We have noted when stirring is helpful in the recipes. Always bring the outside edges towards the centre and the centre portions to the outside.

### Rearranging or Turning

Some foods should be turned in the container during cooking. For example, because of the different thicknesses in the breast and back sections of poultry, it is a good idea to turn poultry over once to ensure more even cooking.

Rearranging or turning over uneven shaped food in the dish should be done as suggested to ensure a satisfactory result. Rearrange small items such as chicken pieces, prawns, hamburger patties, nuts or potatoes. Rearrange pieces from the centre to the edge of the dish.

### Cooking in Layers

This microwave oven is not designed to cook more than 1 layer of food. Cooking in 2 layers may not always be successful, it takes longer and may be uneven. You can successfully reheat two dinner plates of food at one time but remember to increase the reheating time and use a microwave warming rack.

### Piercing of Foods

Pierce the skin or membrane of foods such as eggs, tomatoes and jacket potatoes when cooked whole in the microwave oven. This allows steam to escape. If the skin has not been pierced, food may burst.

### Cured Meats

Cured meats may overcook in some areas due to the high concentration of salts used in the curing process. So take care when cooking different brands of bacon as cooking times may vary slightly.

## Techniques for Preparation

### Covering

Covering food minimizes the microwave cooking time. Because microwave cooking is done with time and not direct heat, the rate of evaporation cannot be easily controlled. However, this can be corrected by using different materials to cover dishes. Plastic wrap is the best substitute for a lid as it creates a tighter seal and so it retains more heat and steam. Wax paper and paper towels hold the heat in but not the steam. These materials also prevent splattering. Use a paper towel, wax paper or no cover when steam is not needed for tenderising.

### Browning

Meats and poultry, when cooked longer than 10 to 15 minutes, will brown from their own fat. Foods cooked for shorter periods of time can be aided with the help of a browning sauce, worcestershire sauce or soy sauce. Simply brush one of these sauces over meat or poultry before cooking. Baked goods do not need long cooking time and therefore, do not brown. When cakes or cupcakes are iced, no one will notice the visual difference. For cakes or cupcakes, brown sugar can be used in the recipe in place of caster sugar or the surface can be sprinkled with dark spices before baking.

### Standing Time

The moisture molecules continue to vibrate in the food when the microwave oven has turned itself off. After all, the molecules were vibrating at 2,450,000,000 times per second during cooking. So cooking continues even after the food is no longer being exposed to the microwaves whether in or outside your microwave oven.

Standing time refers to the time it takes (after the microwave time is completed) to allow the interior of the food to finish cooking.

The amount of standing time varies with the size and density of the food. In meat cookery, the internal temperature will rise between 5 °C and 10 °C if allowed to stand covered for ten to fifteen minutes. Rice and vegetables need shorter standing time, but this time is necessary to allow foods to complete cooking in the centre without overcooking on the edges.

The power level used in microwave cooking also determines the standing time. For example, when using a lower power level the standing time is shorter because of a lower concentration of heat in the food. Foods should always be kept covered while standing in order to retain the heat. If a longer standing time is required (while you cook another food to serve with the first, for instance), cover with aluminum foil.

## Converting Your Favourite Conventional Recipes for Microwave Cooking

When adapting conventional recipes for microwave cooking, time are reduced considerably.

For example, a chicken which takes 1 hour to cook in a moderate oven will take 15 to 20 minutes on **P7** Power in your microwave oven.

Use similar microwave recipes to help you adapt conventional recipes. Remember, it is always best to undercook a recipe and then add an extra minute or two to finish it off.

Here are some other tips that may help:

- Reduce liquids in a conventional recipe by one half to two thirds, e.g. 1 cup (250 ml) should be reduced to ½ cup (125 ml).
- Add more thickening such as flour or cornflour to sauces and gravies if you do not reduce the liquid.
- Reduce seasonings slightly in a recipe where ingredients do not have time to simmer by microwave.
- Do not salt meats, poultry or vegetables before cooking; otherwise, they will toughen and dry out.
- If one ingredient takes longer to cook than the others, pre-cook it in the microwave oven first. Onion, celery and potato are examples.
- When cooking meat or vegetables, omit any oil or fat that would have been used in a conventional recipe for browning.
- Reduce leavening agents for cakes by one quarter and increase liquids by one quarter.
- Biscuits require a stiff dough. Increase flour by about 20 percent. Substitute brown sugar for white sugar and use biscuit recipes that have dark spices or require icing. Because of the short cooking time, biscuits don't have time to brown. Chill dough for half an hour before baking. This produces a crisper biscuit. Bake biscuits on a glass tray lined with greaseproof paper.
- Since microwaves penetrate foods about two centimetres from the top, bottom and sides, mixtures in round shapes and rings cook more evenly. Corners receive more energy and may overcook.
- Items with a lot of water, such as rice and pasta, cook in about the same time as they would on a conventional stove. (Refer to **Rice** and **Pasta** chapter.)

Select recipes that convert easily to microwave cooking such as casseroles, stews, baked chicken, fish and vegetable dishes. The results from foods such as grilled meats, cooked souffles or two-crust pies could be less than satisfactory. Never attempt to deep fry in your microwave oven.

## Menu Planning for Microwave Cooking

### How to Keep Everything Hot at The Same Time

Plan your meals so that the food will not all need last minute cooking or attention at the same time. The special features of microwave cookery make it easy to serve meals with everything piping hot. Cooking of some foods may be interrupted while you start others, without harming the nutritional value or flavour of either.

A recipe which requires standing time can be microwaved first and another food cooked while it stands. Dishes prepared in advance can be reheated briefly before serving.

It does take some experience and time to cook with confidence. Microwaves are fast so you will have to do some experimenting. You might find you will use your conventional range in conjunction with your microwave oven. For example, while cooking the roast in the microwave oven, you can be cooking the vegetables and gravy on the range top. This can also be done the other way around. Prepare your meals as follows.

1. Firstly, cook the most dense item (roast or casserole). Drain and retain meat juice from joints then cover with foil.
2. Cook the potatoes, rice or pasta.
3. Cover with foil for standing.
4. Cook greens and other vegetables.
5. Cover with foil for standing.
6. Cook the gravy with the retained meat juices, stock and thickening.
7. Carve the roast and serve the vegetables and gravy.

While you are learning to plan meals, you may get a bit behind time. Don't worry. Dinner servings may be suitably reheated on **P7**, for 1 to 2 minutes per serving.

If you prefer not to use foil, cover food with saucepan lids. A metal lid will retain the heat for at least 15 minutes.

Meanwhile, how can you cook all the vegetables at the same time? Simply place potatoes and pumpkin in one dish and less dense vegetables such as broccoli, cabbage, cauliflower, beans and peas in another. Sprinkle greens with water. Cover with a lid or plastic wrap. Cook on **P10** for cooking times refer to vegetable cooking chart on page 55-56. Fresh and frozen vegetables can be mixed on a vegetable platter, but remember frozen vegetables are not as dense as fresh vegetables, as they have been blanched before freezing.

If vegetables are cut to a similar size, they can be cooked in separate ramekins or small dishes at the same time.

## Increasing & Decreasing Recipes

### Increasing

- To increase a recipe from 4 to 6 servings, increase each ingredient listed by half.
- To increase a recipe from 4 to 8 servings, double each ingredient listed.
- For larger quantities of a recipe, a large dish should be used. Make sure that the dish is deep enough to prevent the recipe from boiling over during cooking.
- Make sure to cover, stir or rearrange food as directed in the recipe and always check the food during cooking.
- Increase standing times by 5 minutes per 500 g.
- Use the same Power Level recommended in the original recipe.
- Increase the cooking times by:  $\frac{1}{3}$  of original cooking time for 6 servings; and an extra  $\frac{1}{2}$  of original cooking time for 8 servings.

### Decreasing

- To decrease a recipe from 4 to 2 servings, decrease each ingredient listed by half.
- For small quantities, a small dish should be used. Make sure that the dish is large enough to prevent the recipe from boiling over during cooking.
- Use the same Power Level recommended in the original recipe.
- Decrease the cooking times by  $\frac{1}{2}$  to  $\frac{2}{3}$  of the original cooking time.

## Cooking for One

- To decrease a recipe from 4 to 1 serving, quarter each ingredient listed.
- A smaller dish should be used, making sure that the dish is still large enough to prevent the recipe from boiling over.
- Use the same Power Level recommended in the original recipe.
- Quarter the original cooking times, then add extra time, if needed.
- Make sure to cover, stir or rearrange food as directed in original recipe and always check the food during cooking.



## Converting Recipes from Other Sources

When the recipe is written with a wattage different than your oven, adjust the cooking time by approximately 10% per 100 watts, e.g. 6 minutes would be adjusted by 36 seconds. Alternately, adjust the power level by one level. If your wattage is higher than the recipe: (1) Adjust time downward or (2) Adjust power level downward. If your wattage is lower than the recipe: (1) adjust time upward or (2) adjust power level upward (when possible).

## Converting Recipes from Other Sources

One of the most common uses for a microwave oven is to reheat food. Your Panasonic microwave allows you to either reheat by placing food into the oven and you choose the micro power level and length of heating time or you may reheat automatically by using the **Sensor Reheat** pad on your microwave. Following are some directions for reheating pre-cooked foods from either refrigerated temperature or room temperature.

## General rules for reheating foods by Micro Power

- Many convenience foods contain heating instructions on the packaging. It is best to follow these instructions, being sure to check the wattage of the oven they used and adjust the cooking time if necessary (decrease cooking time by 10% for every 100 watts more powerful your oven is).
  - If package directions are not available, follow the recommendations in the charts on the following pages.
  - All foods must be pre-cooked; raw foods will not cook through during reheating times and if consumed may cause illness.
  - Do not reheat in foil containers, cans or plastic containers as incorrect heating times will result. Place foods into microwave safe bowls or onto dinner-plates before heating.
  - Most foods can be heated on **P10** but consider if the food is delicate in structure like baked custard or you have a large quantity, a lower power level for slightly longer may be gentler.
  - Cover foods with plastic wrap if you require a steamed effect or leave uncovered for a drier surface, e.g. Crumbed foods.
- Note:** When cooking by Sensor Cook all food must be covered.
- Stir or re-arrange foods during heating as this will help food heat evenly. Stir after heating and let stand for 2 to 3 minutes. Check temperatures before adding extra heating time and ensure food is hot. If food is not heated enough, consumption may cause illness.

### Caution:

Pastry items which have a filling that is high in fat, sugar or moisture will become hotter in the centre and the pastry may only feel warm. Ensure you allow it to stand for several minutes before eating.

## Reheating by Micro Power - Frozen Pre-cooked Foods

FROZEN ITEM (Pre-cooked)	POWER	TIME (in minutes)	SPECIAL INSTRUCTIONS
<b>BREAD &amp; BAKED PRODUCT</b>			
Bread 1 slice	P7	10 - 15 sec	Do not let bread get hot, or it will become rubbery and dry out. Remove whole loaf from original wrapper. Place on paper towel to absorb moisture.
1 loaf	P7	1 - 3	
6 rolls	P6	1 - 2	
Cheesecake (450 g)	P3	5 - 7	Remove from container. Defrost on plate.
Muffins - 4 (400 g)	P7	1½ - 2	Place onto paper towel lined plate.
Scones - 6 (400 g)	P6	1½ - 2	Defrost on paper lined plate. Stand 2 minutes.
<b>PIES</b>			
Fruit Pie (600 g)	P3 then P7	5 - 7  5 - 7	Remove from foil container and place uncovered into a pie dish.
Meat Pie (175 g)	P7	4 - 5	
Pizza (350 g)	P10	5 - 7	Remove from package and place onto paper towel or follow manufacturer's instructions.
<b>FROZEN MEAL</b>			
Fish in Sauce (200 g)	P5	5 - 7	Pierce corner of bag. Heat on a plate.
Frozen Casserole (500 g)	P10	9 - 11	Pierce pouch. Heat on a plate or bowl.
Lasagne (500 g)	P9	11 - 13	Remove from foil container, place into serving dish.
Plated style dinner (320 g)	P5	8 - 10	Remove foil cover and replace with plastic wrap.
Vegetables & Sauce (in the bag) (500 g)	P7	6 - 8	Pierce corner of bag. Heat on a plate.
<b>MISCELLANEOUS</b>			
Chicken Pieces (500 g)	P7	8 - 10	Place onto paper towel lined plate.
Chicken Nuggets (12)	P7	3 - 4	Place onto paper towel lined plate.
Croissants - 4 (200 g)	P3	1 - 1½	Place onto paper towel lined plate.
Fish Fingers - 8 (200 g)	P3 then P10	2 - 4  2 - 3	Place onto paper towel lined plate.
Sausage Rolls (225 g)	P5	2 - 3	

Reheat

---

## IMPORTANT POINTS TO CONSIDER WHEN REHEATING COLD FOODS

---

### STARTING TEMPERATURE —

Foods taken from the refrigerator will take longer to reheat than foods from room temperature.

### Quantity —

One serving heats faster than several servings. When heating large quantities, stir food to ensure even heating. It is quicker to heat individual plates of food than large quantities in a casserole dish.

### Plated Dinners —

Arrange foods with the most dense items towards the outside of the plate. Cover meats with sauces/ gravies if desired, spread out mashed potatoes or rice so it heats more evenly. When assembling plates of leftover foods, use foods which have a similar starting temperature.

### Covering Foods —

Most foods need to be covered with one sheet of absorbent paper towel to hold in the heat and prevent splattering without steaming. When more moisture is desired, cover with plastic wrap.

### Heating —

Reheating is usually done on **P10**, however, if food has a more delicate texture, like a baked custard, a lower power setting should be used. **P7** for a little longer will be gentler on the food. An average plate of food would generally take 1 to 3 minutes to heat depending on the density of the food. Place it in for the minimum time and add extra heating time if required.

Ensure food is hot by feeling the bottom of the plate in the centre. If the plate is cool, food may be warm but will lose heat quickly as the plate will absorb the heat and taste cold when served.

If food is not heated enough, consumption may cause illness.

### Elevation —

Elevate pastries and breads on a small plastic rack with paper towel under the food to prevent it from becoming soggy.

#### Caution:

Pastry items which have a filling that is high in fat., sugar or moisture will become hotter in the centre and the pastry may only feel warm. Ensure you allow it to stand for several minutes before eating.

---

## IMPORTANT POINTS TO CONSIDER WHEN REHEATING FOODS FROM THE FREEZER

---

### VOLUME —

The greater the volume and the more dense the item, the longer it takes to reheat, e.g. frozen cake will take less time than frozen casserole.

### LARGE VOLUME —

Large, dense, frozen precooked foods are best thawed on defrost until icy in the centre then heated on **P7**. This prevents overcooking of the edges. Stirring is often needed to distribute heat evenly.

### Commercial frozen foods —

These foods should be removed from their foil containers if possible and placed into suitable microwave safe containers. If a foil container is used in the microwave oven it shouldn't be more than 4 cm high and must not touch the interior of the microwave oven. Remove the cover from the tray and replace with paper towel or plastic wrap to prevent splattering.

### Foods to be served at room temperature —

For best results, defrost for a short time and allow to stand to complete thawing, e.g. frozen cake.

### Vacuum sealed pouches —

Pierce pouches, bags before heating to allow steam to escape. This prevents bursting.

### Containers —

Use dishes about the same volume of the food or slightly larger to allow for stirring. Remove or release snap seal lids other wise they will pop during heating and may disfigure.

### Pies and pastries —

Pies and pastries that contain raw pastry and filling cannot be cooked in the microwave oven. Precooked products can be thawed and heated. Place them on a sheet of paper towel and elevate on plastic rack for best results. For added crispness place under the grill or in a hot oven for few minutes. Pastry items can become tough and rubbery if overheated, remember to allow 5 minutes standing then test before adding extra heating time.



**PUMPKIN SOUP**

Serves: 4

**Ingredients:**

1 kg	diced pumpkin
1	onion, diced
500 ml	chicken stock
1 teaspoon	curry powder
	pepper

**Method:**

Place pumpkin, onion and curry powder in a 2-litre casserole dish. Cover and cook on **P10** for 12 minutes. Add chicken stock and pepper. Cook on **P10** for 10 minutes. Cool slightly. Purée pumpkin and liquid in blender or food processor. Pour into individual serving dishes and garnish with chives.

**SHORT AND LONG SOUP**

Serves: 4

**Ingredients:**

200 g	fresh singapore noodles
12 (200 g)	frozen mini dim sims
4	green onions, sliced
1 L	chicken stock
1 teaspoon	crushed garlic
½ teaspoon	chopped ginger
2 tablespoons	soy sauce
1	chicken breast, cooked and sliced
4	baby bok choy, quartered
1 cup	bean sprouts
2 tablespoons	dried onion (optional)

**Method:**

Place all ingredients except bok choy and bean sprouts in a 4 litre casserole dish and cook on **P10** for 10 minutes. Add bok choy and cook on **P10** for 2 minutes. Serve in individual bowls topped with bean sprouts and onion.

**HINT:**

To cook 1 double chicken breast. Place onto a dinner plate. Cover and cook on **P7** for 8 to 10 minutes.

**PEA AND HAM SOUP**

Serves: 6

**Ingredients:**

2½ cups	green split peas
850 g	smoked ham hock
1	medium onion, chopped
1 tablespoon	fresh thyme leaves
1	bay leaf
1½ L	chicken stock
½ cup	frozen peas

**Method:**

Wash split peas and place in a 2-litre capacity bowl with 1-litre of water. Cover and allow soaking for 8 hours or overnight. Remove rind from ham hock and discard. Cut meat away from the bone and roughly chop. Reserve bone. Drain peas and place into a 5-litre capacity microwave safe dish. Add ham bone, chopped ham, onion, thyme, bay leaf and chicken stock. Cook uncovered on **P10** for 15 minutes. Reduce power to **P6** and cook for 15 minutes. Skim top of soup and cook on **P6** for a further 30 minutes. Remove ham bone and bay leaf and stir in frozen peas. Cook on **P6** for 10 minutes. Blend half the soup and return to the bowl, stirring through the remaining soup. Serve hot with crusty bread.

**Tip:**

Substitute 500 g bacon bones and 250 g of diced bacon rashers for the ham hock. Do not add salt when cooking lentils or pulses, as they will toughen. Add salt after cooking if desired.

**POTATO AND LEEK SOUP**

Serves: 4 to 6

**Ingredients:**

1 kg	potatoes, peeled and diced
2	medium thinly sliced leeks
2 teaspoons	fresh thyme
	pepper
750 ml	chicken stock
150 ml	cream

**Method:**

Place potatoes, leeks, thyme and pepper in 4-litre casserole dish. Cover and cook on **P10** for 8 minutes. Stir in chicken stock. Cover and cook on **P10** for 14 to 16 minutes. Purée soup mixture. Stir in cream and serve hot or cold in individual bowls.

**CHICKEN AND PRAWN LAKSA**

Serves: 4

**Ingredients:****Soup:**

2 tablespoons	laksa paste
400 ml	coconut milk
1 L	chicken stock
1 tablespoon	soy sauce
	fresh ground black pepper

**Laksa:**

250 g	rice noodles
2 L	boiling water
1 bunch	coriander, leaves chopped
4	small red chillies, seeds removed and finely chopped
½ cup	bean sprouts
4	limewedges
1 tablespoon	peanut oil
400 g	cooked chicken tenderloins, sliced
12	green king prawns, peeled

**Method:****Soup:**

Place the laksa paste, coconut milk, stock, soy sauce and pepper into a 3-litre dish and cook covered on **P10** for 8 to 10 minutes.

**Laksa:**

Place the noodles and water in a 4 litre dish. Cover and cook on **P10** for 2 to 3 minutes, stirring halfway through. Drain well and divide between 4 deep bowls. Place the coriander, chillies, bean sprouts and lime on top. Place the peanut oil and prawns in a 1-litre dish and cook on **P7** for 3 to 5 minutes, stirring halfway through. Add the chicken and prawns to each individual bowl and set aside.

**To serve:**

Heat soup on **P10** for 2 minutes. Pour the hot soup over the ingredients in the 4 bowls and serve.

**ZUCCHINI SLICE**

Serves: 4 to 6

**Ingredients:**

4 rashers	bacon, diced
1	onion, diced
2 cups	grated zucchini
2 cups	grated carrot
1 cup	grated tasty cheese
1 cup	self raising flour
5	eggs, lightly beaten
125 ml	vegetable oil
1 tablespoon	fresh chopped parsley
	salt and pepper

**Method:**

Lightly grease a 25 cm square microwave safe dish. Place bacon and onion in a 2-litre casserole dish and cook on **P10** for 2 to 3 minutes. Allow to cool slightly. Stir in zucchini, carrot and cheese and flour. In a 1-litre bowl whisk together eggs, oil and parsley. Add to bacon mixture season with salt and pepper and stir until combined. Pour into prepared dish. Cook on **P6** for 22 to 24 minutes.

**NACHOS SUPREME**

Serves: 4 to 6

**Ingredients:**

500 g	topside mince
35 g	packet taco seasoning mix
½ cup	tomato paste
1 teaspoon	Mexican chilli powder
310 g	red kidney beans, mashed in liquid
180 g	packet corn chips
1	avocado
½ cup	sour cream
½ cup	grated cheese
	paprika

**Method:**

Place meat in a 2-litre dish. Cook on **P7** for 6 minutes, stirring halfway through. Mix with fork, breaking up any large pieces of meat. Add taco mix, tomato paste, chilli powder and kidney beans. Cook on **P7** for further 10 minutes, stirring halfway through cooking. Place corn chips in a 3-litre microwave suitable serving dish. Pile meat sauce in the centre. In a small bowl, mash avocado and mix in sour cream. Spoon this mixture over meat sauce and top with grated cheese. Sprinkle with paprika. Heat on **P7** for 3 to 4 minutes.

**NUTS AND BOLTS**

Serves: 6 to 8

**Ingredients:**

80 g	butter
2 teaspoons	curry powder
2 tablespoons	worcestershire sauce
½ teaspoon	salt
¼ teaspoon	garlic powder
100 g	packet mixed rice crackers
100 g	fried noodles
200 g	salted peanuts
125 g	packet pretzel sticks
½ cup	Nutri-Grain

**Method:**

Place butter, curry, worcestershire sauce, salt and garlic powder in a 3-litre casserole dish. Cook on **P10** for 1 to 2 minutes. Add remaining ingredients, mix well and cook on **P10** for 4 to 5 minutes. Stir twice through cooking. Allow to cool. Place in a bowl and serve with drinks. Store in an airtight container once cool.

## Cooking Fish and Shellfish by Micro Power

Clean fish before starting the recipe. Arrange fish in a single layer, overlap thin fillet ends to prevent overcooking. Prawns and scallops should be placed in a single layer. Cover dish with plastic wrap. Cook on the power level and for the minimum time recommended in the chart below. Halfway through cooking rearrange or stir prawns, fish fillets or scallops

### Cooking Fish and Shellfish by Micro Power

FISH OR SHELLFISH	AMOUNT	POWER	APPROX. COOKING TIME (in minutes)
Fish Fillets	500 g	P4	8 to 10
Scallops (sea)	500 g	P4	6 to 8
Green Prawns medium size (shelled and cleaned)	500 g	P4	7 to 9
Whole Fish (stuffed or unstuffed)	500 g to 600 g	P4	7 to 10

#### GARLIC & CHILLI PRAWNS

Serves: 4

##### Ingredients:

1 kg medium uncooked king prawns  
 1 small red onion, thinly sliced  
 40 g butter  
 3 garlic cloves, crushed  
 2 fresh bird's eye chillies, deseeded & finely chopped  
 ½ small red capsicum, finely sliced  
 100 g snow peas, trimmed  
 1 tablespoon lemon juice  
 80 ml thickened cream  
 ¼ cup coriander leaves, chopped  
 Cooked jasmine rice, to serve

##### Method:

Peel and de-vein prawns leaving tails in tact, set aside. Place onion, butter, garlic and chilli into a 3 Litre microwave safe dish. Cook on **P10** for 4 minutes, stir halfway through cooking. Add prawns and mix to combine. Cook on **P7** for 3 minutes. Stir in capsicum and snow peas, cover and cook on **P7** for a further 3 minutes. Stir through lemon juice, cream and coriander, season and cook on **P10** for 1 minute. Serve immediately with cooked rice.

#### GARLIC PRAWNS

Serves: 2

##### Ingredients:

60 g butter  
 2 clove garlic, crushed  
 1 tablespoon lemon juice  
 1 tablespoon chopped parsley  
 500 g peeled green prawns

##### Method:

Place butter and garlic in a 1-litre dish and cook on **P10** for 30 to 50 seconds. Add lemon juice, parsley and prawns. Cook on **P6** for 5 to 7 minutes, stirring halfway through cooking. Serve in individual ramekins.

#### STEAKS WITH LIME BUTTER

Serves: 4

##### Ingredients:

30 g butter  
 1 clove garlic, crushed  
 1 teaspoon grated fresh ginger  
 1 teaspoon grated lime rind  
 2 tablespoons lime juice  
 ½ teaspoon sugar  
 500 g salmon, steaks

##### Method:

Place butter, garlic, ginger, lime rind, juice and sugar in a shallow dish. Cook on **P7** for 1 to 2 minutes. Stir halfway through cooking. Add salmon steaks and coat with sauce. Cover and cook on **P5** for 5 to 7 minutes. Stand for 2 to 3 minutes before serving.

#### LEMON PEPPER FISH

Serves: 2

##### Ingredients:

350 g fish fillets  
 ¼ cup lemon juice  
 1 teaspoon cracked black pepper

##### Method:

Place fish, lemon juice and cracked black pepper in 1-litre casserole dish. Cook on **P4** for 4 to 6 minutes. Let stand for 3 minutes before serving.

## BOUILLABAISSÉ

Serves: 4 to 6

### Ingredients:

2 tablespoons	olive oil
2	onions, sliced
1	large leek, sliced
4 cloves	garlic, crushed
425 g	tomato pieces
½ cup	tomato paste
1 L	hot fish stock
½ cup	dry white wine
1 tablespoon	fresh thyme leaves
½ teaspoon	saffron powder
1 teaspoon	chilli powder
	freshly ground black pepper
	salt
500 g	firm fish fillets, chopped
500 g	green prawns meat de-veined

### Method:

Place oil, onions, leek and garlic in a 4-litre dish. Cover and cook on **P10** for 6 to 8 minutes. Stir halfway through cooking. Add tomatoes, tomato paste, fish stock, wine, thyme, saffron, and chilli powder. Season with salt and pepper. Cook on **P10** for 12 minutes. Add fish fillets and prawns. Cook on **P10** for 8 to 10 minutes or until seafood is cooked. Serve garnished with fresh thyme.

## TOMATO BASIL MUSSELS

Serves: 4

### Ingredients:

1 kg	fresh mussels
60 ml	water
1 tablespoon	olive oil
1	leek, sliced
1 clove	garlic, crushed
1 (425 g)	can tomato pieces
1 tablespoon	tomato paste
½ teaspoon	oregano
2 tablespoons	chopped fresh basil
	freshly ground black pepper

### Method:

Place mussels and water into a bowl. Cover and cook on **P7** for 4 to 6 minutes. Set aside. Place oil, leeks and garlic into a 3-litre dish. Cook on **P10** for 2 minutes. Stir well, add tomatoes, tomato paste, oregano, basil and pepper. Mix well. Cook on **P10** for 3 to 4 minutes. Add mussels. Cover and cook on **P10** for 2 to 3 minutes. Serve immediately.

## OYSTERS KILPATRICK

Makes: 12

### Ingredients:

2 rashers	bacon finely chopped
1 tablespoon	worcestershire sauce
2 teaspoons	lemon juice
1 tablespoon	barbecue sauce
12	oysters in shell

### Method:

Spread bacon onto a dinner plate. Cover with paper towel and cook on **P10** for 2 to 3 minutes. Mix together worcestershire sauce, lemon juice and barbecue sauce. Place oysters in shell evenly around dinner plate and sprinkle with bacon mixture. Pour some sauce mixture over each oyster. Cook on **P10** for 1 to 1½ minutes. Serve with drinks or as an entree.

## SEAFOOD MARINARA

Serves: 4

### Ingredients:

750 g	Marinara mix
2 tablespoons	butter
1	clove garlic, crushed
2	tomatoes, peeled and chopped
1 tablespoon	tomato paste
¼ cup	white wine
¼ cup	fresh basil leaves, chopped
	pepper

### Method:

Place marinara mix into a 2-litre casserole dish. Set aside. Place butter and garlic in 1-litre casserole dish. Cook on **P7** for 1 minute. Add remaining ingredients (except seafood), to dish and cook on **P10** for 5 minutes. Purée tomato mixture in blender or food processor and pour over seafood. Cook on **P6** for 7 to 9 minutes, stir halfway through cooking. Stand for 5 minutes. Serve with salad and pasta.

## Cooking Whole Poultry by Micro Power

Season as desired, but salt after cooking. Browning sauce mixed with equal parts of butter will enhance the appearance.

Poultry must be unstuffed. Tie legs together with cotton string. Place on a microwave rack set in a rectangular dish. Place poultry breast-side down: turn over halfway through cooking. Cover with wax paper to prevent splattering.

If the poultry is not cooked enough, return it to the oven and cook a few more minutes at the recommended power level.

**DO NOT USE A CONVENTIONAL MEAT THERMOMETER IN THE MICROWAVE OVEN.**

Let stand, covered with foil, 10 to 15 minutes after cooking. Standing time allows the temperature to equalize throughout the food and finishes the cooking process.

If a large amount of juice accumulates in the bottom of the baking dish, occasionally drain it. If desired, reserve juices for making gravy.

Less-tender birds should be cooked in liquid such as soup or broth. Use ¼ cup per 500 g of poultry.

Use an oven cooking bag or a covered casserole. Select a covered casserole deep enough so that bird does not touch the lid.

If an oven cooking bag is used, prepare according to package directions. Do not use wire twist-ties to close bag. Use only nylon tie, a piece of cotton string, or a strip cut from the open end of the bag. Make six 2 cm slits on top of bag.

Multiply the weight of the poultry by the minimum recommended minutes per 500 g. See chart below. Programme Micro Power and Time.

After cooking, check the internal temperature of the bird with a microwave or conventional meat thermometer inserted into the muscle. Check temperature in both muscles. The thermometer should not touch bone. If it does, the reading could be inaccurate. A thermometer cannot be accurately inserted into a small bird. To check desired cooking of a small bird, juices should be clear and the drumsticks should readily move up and down after standing time.

During cooking, it may be necessary to shield legs, wings and the breast bone with foil to prevent overcooking. Wooden toothpicks can be used to hold foil in place.



## Cooking Poultry Pieces by Micro Power

Cover with wax paper or paper towel. Use the chart below to determine recommended minimum cooking times.

Arrange pieces skin-side down and evenly spread in a shallow dish.

Turn or rearrange halfway through cooking. Shield wing tips, drumstick ends etc., if required.



### Cooking Poultry by Micro Power

POULTRY	POWER	TEMPERATURE AFTER COOKING	APPROX. COOKING TIME (minutes per 500 g)
Chickens	P7	87 °C	10 to 15
Chicken (pieces)	P7	87 °C	8 to 10
Turkey	P7	87 °C	12 to 17
Duck	P7	87 °C	10 to 15

## COOKING EGGS BY MICRO POWER

**Boiled Eggs:** Do not boil eggs in your microwave. Raw eggs boiled in their shells can explode and cause serious injury.

**Poached Eggs:** The membrane on egg yolks must be pierced before cooking, otherwise steam will build up and cause yolk to pop.

**Scrambled Eggs:** Slightly undercook scrambled eggs as they will finish cooking during standing.

## SCRAMBLED EGGS

Serves: 2

### Ingredients:

2 x 60 g	eggs
2 tablespoons	milk
	pinch of salt

### Method:

In a 1-litre casserole dish, beat eggs lightly with whisk. Add milk and salt. Whisk until well combined. Cover dish with plastic wrap and cook on **P6** for 1 to 1½ minutes. Stir eggs and cook for further 1 to 1½ minutes. Stand, covered, for 1 minute before serving.

## POACHED EGGS

Serves: 2

### Ingredients:

2 x 60 g	eggs
125 ml	hot tap water
	dash of vinegar
	pinch of salt

### Method:

Place one quarter of cup of water, dash of vinegar and pinch of salt into 2 ramekin dishes or small glass bowls. Heat water on **P10** for 30 - 60 seconds. Break egg into the water and with toothpick pierce the egg yolk twice and egg white several times. Cover dishes with plastic wrap and cook on **P6** for 1 to 1½ minutes.

Stand, covered, for 1 minute before serving.

**Note:** The size of the eggs will alter cooking time.

## BACON AND EGG IN A CUP

Serves: 1

### Ingredients:

2	slices bacon
1 x 60 g	egg
1 tablespoon	grated cheddar cheese

### Method:

Place bacon on a dinner plate between 2 sheets of paper towel cook on **P10** for 1 to 2 minutes. Wrap bacon around the inside of a 1-cup remekin dish. Crack egg into centre of dish and pierce with tooth pick. Cover and cook on **P5** for 50 to 70 seconds. Sprinkle with grated cheese.

## GREEN PEPPERCORN CHICKEN

Serves: 4

### Ingredients:

500 g	sliced chicken breast fillets
2 tablespoons	green peppercorns
1 tablespoon	seeded mustard
1 teaspoon	chicken stock powder
2 tablespoons	lemon juice
½ cup	cream

### Method:

Place chicken in a 3-litre casserole dish. Cook on **P7** for 8 to 10 minutes stirring halfway through cooking. Mix together peppercorns, mustard, stock powder, lemon juice and cream. Pour over chicken, stir. Cook on **P10** for 2 to 3 minutes.

## CHICKEN CURRY

Serves: 4

### Ingredients:

1	onion, chopped
2 tablespoons	red curry paste
500 g	chicken fillets, sliced
1 tablespoon	fish sauce
1 tablespoon	brown sugar
2 cups	finely sliced vegetables
1 cup	coconut milk

### Method:

Place onion and curry paste in a 3-litre casserole dish. Cook on **P10** for 2 to 3 minutes. Add chicken and combine. Cook on **P7** for 6 minutes, stirring once during cooking. Add fish sauce, brown sugar, vegetables and coconut milk. Stir well. Cover and cook on **P10** for 4 to 6 minutes. Serve with Jasmine rice.



### CHICKEN CACCIATORE

Serves: 4

#### Ingredients:

400 g	can diced tomatoes
¼ cup	tomato paste
1 teaspoon	minced garlic
1	onion, diced
2 teaspoons	dried oregano
1 kg	chicken drumsticks
¼	red capsicum, sliced

#### Method:

Place all ingredients in a 2-litre casserole dish. Stir until combined. Cover and cook on **P7** for 10 to 12 minutes. Turn chicken and stir. Cook on **P7** for 10 to 12 minutes.

### ROAST CHICKEN

Serves: 4 to 6

#### Ingredients:

1.5 kg	chicken
2 tablespoons	melted butter
	seasonings of your choice lemon, pepper, seasoned salt, etc.

#### Method:

Clean and pat dry chicken with paper towel. Brush chicken with melted butter and sprinkle with seasoning. Place chicken, breast-side down, on rack in 3-litre dish. Cook on **P7** for 30 to 35 minutes. Turn halfway through cooking.

#### HINT:

After cooking whole poultry, cover with foil to retain heat while finishing the remainder of the meal.

### CHICKEN BURRITOS

Serves: 4

#### Ingredients:

1	clove garlic, crushed
2	large onions, chopped
1 teaspoon	chilli powder (optional)
35 g	taco seasoning mix
500 g	chicken tenderloins, diced
425 g	can red kidney beans, drained
½ cup	tomato paste
125 ml	water
1 cup	grated cheese
12	tortillas

#### Method:

Place garlic, onion and chilli in a 3 litre casserole dish. Cook on **P10** for 2 minutes. Stir in remaining ingredients except cheese and tortillas. Cover and cook on **P7** for 16 to 18 minutes, stirring twice during cooking. Serve in warmed tortillas topped with grated cheese.

### THAI CHICKEN WINGS

Serves: 3 to 4

#### Ingredients:

1 kg	chicken wings
2 tablespoons	soy sauce
2 tablespoons	fish sauce
2 tablespoons	lime juice
1 teaspoon	crushed garlic
1 teaspoon	crushed ginger
1 teaspoon	crushed chilli

#### Method:

Place wings into a shallow dish. Combine remaining ingredients and pour over wings. Marinate for at least 2 hours in the refrigerator. Cook on **P7** for 15 to 20 minutes, rearranging halfway through cooking.

### APRICOT NECTAR CHICKEN

Serves: 4

#### Ingredients:

400 ml	apricot nectar
40 g	French onion soup mix
1	onion, diced
1	clove garlic, crushed
½ cup	dried apricots
1 kg	chicken legs

#### Method:

Place all ingredients except chicken legs into a 3-litre dish. Mix well to combine. Add chicken legs and stir to coat with sauce. Cook on **P7** for 20 to 25 minutes, stirring halfway through cooking.

### CHICKEN SAN CHOY BAU

Serves: 4 to 6

#### Ingredients:

10	dried shiitake mushrooms
2 teaspoons	sesame oil
1	clove garlic, chopped
500 g	minced chicken
10	water chestnuts, finely chopped
227 g	can bamboo shoots, chopped
¼ cup	soy sauce
1 tablespoon	oyster sauce
2 tablespoons	dry sherry
1	small iceberg lettuce

#### Method:

Cover mushrooms with boiling water, stand for 30 minutes. Drain, remove stems and chop finely. Place oil and garlic in a 2 litre casserole dish, cook on **P10** for 40 to 50 seconds. Add chicken and cook on **P7** for 5 to 6 minutes. Add remaining ingredients except lettuce and cook on **P7** for 5 to 6 minutes. Separate lettuce leaves. place tablespoons of mixture into each lettuce leaf. Serve immediately.

### CHICKEN ROLLS WITH HONEY MUSTARD

Serves: 4 to 6

#### Ingredients:

8	chicken thigh fillets
16	prunes, pitted
8	green onions, sliced
2 tablespoons	flaked almonds
4 rashers	rindless bacon, halved lengthwise

#### Honey Mustard Glaze

1 tablespoon	brown sugar
1 tablespoon	French Mustard
1 tablespoon	honey
10 g	butter, melted
	ground black pepper

#### Method:

Open out each thigh fillet and trim away fat. Place 2 prunes, some spring onion and a few flaked almonds on each fillet. Roll fillets up and wrap a piece of bacon around each one. Secure with toothpicks. Blend all glaze ingredients together in a small bowl. Place chicken into a 3-litre dish in a single layer and brush with glaze mixture. Cook on **P7** for 16 to 20 minutes, turning halfway through cooking.

### CHICKEN AND ASPARAGUS RISOTTO

Serves: 4

#### Ingredients:

300 g	fresh asparagus, chopped
2 tablespoons	olive oil
1½ cups	arborio rice
1	clove garlic, crushed
1 L	boiling chicken stock
2 cups	coarsely chopped cooked chicken
¼ cup	grated fresh parmesan cheese
¼ cup	cream
	ground black pepper
1 tablespoon	chopped parsley
extra	coarsely grated parmesan cheese

#### Method:

Place asparagus into 2-litre dish and cook on **P10** for 1 minute. Set aside. Place oil, rice and garlic in a large microwave safe bowl. Cook covered on **P10** for 1 minute. Add 2 cups of boiling chicken stock, cook on **P10** for 5 minutes. Stir twice during cooking. Add remaining chicken stock and cook on **P10** for another 5 minutes. Add remaining ingredients along with asparagus and stir into risotto. Cook covered on **P10** for 2 minutes. Stand for 5 minutes. Serve topped with extra parmesan and black pepper.

### HONEY SESAME DRUMSTICKS

Serves: 4

#### Ingredients:

1 kg	chicken drumsticks
1	clove garlic, chopped
1 teaspoon	chopped ginger
¼ cup	soy sauce
¼ cup	honey
2 tablespoons	sesame seeds

#### Method:

Place all ingredients in 2-litre bowl, stir until combined. Marinate for at least 2 hours or overnight. Remove chicken from marinade and place in shallow dish with the meatiest ends to the outside. Cook on **P7** for 15 to 18 minutes, turning once during cooking.

### CHICKEN WINGS IN LEMON SAUCE

Serves: 4 to 6

#### Ingredients:

1 kg	chicken wings
¼ cup	soy sauce
1 teaspoon	ginger powder
2	cloves garlic, crushed
¼ cup	lemon juice

#### Method:

Place chicken wings in 3-litre casserole dish. Mix together remaining ingredients and pour over chicken wings. Marinate for 1 to 2 hours in the refrigerator. Cook, covered, on **P7** for 15 to 20 minutes. Serve hot with rice.



## Cooking Tender Cuts of Meat using Micro Power

For best results, select roasts that are uniform in shape.

Place meat on a microwave rack in a suitable dish. Beef rib roast should be placed cut-side down. Other bone-in roasts should be placed fat-side down. Boneless roasts should be placed fat-side up. Halfway through cooking, turn roasts. Half hams should be shielded by wrapping an 8 cm wide strip of foil around the large end of the ham. Secure to the body of the ham with wooden toothpicks. Fold 3 cm over cut surface. For shank ham halves, shield shank bone by cupping it with foil. One third of the way through cooking, remove ham from oven and cut off skin. Turn fat side up and reshield edges. If desired, glaze last 10 to 20 minutes of cooking. Loosely cover baking dish with wax paper or paper towel to prevent splatter. If a large amount of juice accumulates in the bottom of the dish, drain occasionally. If desired, reserve for making gravy. Multiply the weight of the roast by the minimum recommended times per 500 g. Programme Micro Power and Time.

Meats can be shielded at the beginning of cooking or halfway through cooking. If you wish to shield at the beginning of cooking, remove foil halfway through the cooking time. Beef and pork rib roasts should be shielded around the bones. Foil should extend about 5 cm down from bones. The shank and thin ends of boneless roasts should also be shielded. Make sure foil does not touch the sides of the oven, as arcing may occur. Canned hams should be shielded on the top cut-edge with a 3 cm strip of foil. Wrap strip of foil around ham and secure to body of ham with wooden toothpicks. Fold 2 cm over cut surface. After heating, check temperature using a meat thermometer. The thermometer should not touch bone or fat. If it does, the reading could be inaccurate. Lower temperatures are found in the centre of the roast and in the muscle close to a large bone, such as a pork loin centre rib roast. If the temperatures are low, return meat to the oven and cook a few more minutes at the recommended power level. **DO NOT USE A CONVENTIONAL MEAT THERMOMETER IN THE MICROWAVE OVEN.** Let stand, covered with foil, 10 to 15 minutes. During standing time the internal temperature equalises and the temperature rises 5 °C to 10 °C.

## Cooking Less-Tender Cuts of Meat by Micro Power

Less-tender cuts of meat such as pot roasts should be cooked in liquid. Use ½ to 2 cups of soup, broth, etc. per 500 g of meat. Use an oven cooking bag or covered casserole when cooking less-tender cuts of meat. Select a covered casserole deep enough so that the meat does not touch the lid. If an oven cooking bag is used, prepare the bag according to package directions. Do not use wire or metal twist-ties. Use the nylon tie provided, otherwise, use a piece of cotton string or a strip cut from the open end of the bag. Make six 2 cm slits in top of bag to allow steam to escape. Multiply the weight of the roast by the minimum recommended minutes per 500 g as suggested in the chart below. Programme Power and Time. Turn meat over halfway through cooking. Meat should be tender when cooked.

**Meat Chart for Microwave Cooking**

MEAT	POWER	APPROX. COOKING TIME (minutes per 500 g)
<b>Beef</b>		
Roasts Medium		
Rare	P6	10 to 12
Medium	P6	12 to 14
Well	P6	14 to 16
Pot Roast	P2	25 to 30
<b>Pork</b>		
Leg of Pork	P7	11 to 13
Loin of Pork	P7	11 to 13
Ham Canned (fully cooked)	P7	4 to 5
<b>Lamb</b>		
Medium	P6	8 to 10
Well	P6	12 to 14

**THAI BEEF CURRY**

Serves: 4 to 6

**Ingredients:**

1	onion, thinly sliced
2 tablespoons	Thai green curry paste
500 g	thinly sliced lean beef
½	red capsicum, thinly sliced
1	carrot, thinly sliced
1	zucchini, sliced
200 g	broccoli, broken into flowerets
1 cup	coconut milk
1 tablespoon	soy sauce
1 tablespoon	lemon juice
2 tablespoons	shredded fresh basil
½ cup	roasted unsalted peanuts

**Method:**

Place the onion and curry paste into a 4-litre dish. Cook on **P10** for 2 to 3 minutes. Add the beef and cook on **P10** for 4 to 6 minutes, stirring halfway through cooking. Add the vegetables and coconut milk and cook on **P10** for 6 to 8 minutes. Mix in the soy sauce, lemon juice and basil and serve sprinkled with peanuts.

**MUSSAMAN BEEF CURRY**

Serves: 4

**Ingredients:**

500 g	round steak diced
½ cup	mussaman curry paste
400 g	potato diced
250 ml	coconut milk
250 ml	beef stock
1 tablespoon	brown sugar

**Method:**

Place steak, curry paste and potato in a 3-litre casserole dish cook on **P10** for 6 minutes. Add coconut milk, beef stock and brown sugar, stir, cook on **P5** for 40 minutes. Stir once during cooking serve with jasmine rice.

**BEEF BOURGUIGNONNE**

Serves: 4 to 6

**Ingredients:**

750 g	diced chuck steak
4 rashers	bacon
6	pickling, onions
2 cloves	garlic, minced
¼ cup	red wine
400 ml	tomato puree
½ cup	beef stock
1 teaspoon	minced chilli
1 teaspoon	dried tarragon
250 g	button mushrooms, halved

**Method:**

Place all ingredients except mushroom in a 3-litre casserole dish, stir until combined. Cover and cook on **P7** for 14 to 16 minutes. Stir and cook on **P4** for 28 to 30 minutes. Stir and add mushrooms halfway through cooking.

**CORNED BEEF**

Serves: 4

**Ingredients:**

1.5	corned silverside
1 tablespoon	brown sugar
1 tablespoon	white vinegar
1	onion, cut in half
4	cloves
6	peppercorns
1	bay leaf
1¼ L	water

**Method:**

Rinse corned silverside under cold running water to remove excess salt. Place corned silverside in 4-litre casserole dish. Add remaining ingredients. Cover and cook on **P10** for 10 minutes. Turn meat, cover and cook on **P3** for 1¼ to 1½ hours. Stand corned silverside in cooking liquid for 10 minutes before carving.

**Note:** Depending on the size and shape of the silverside, it may require a further 10 to 15 minutes on **P3**.

**FRENCH ONION BEEF CASSEROLE**

Serves: 4

**Ingredients:**

100 g	onion, chopped
1 teaspoon	minced garlic
200 g	diced potatoes
600 g	beef, diced
100 g	carrots, diced
1/3 cup	tomato paste
1 1/2 cups	beef stock
100 g	whole button mushrooms
1/4 cup	frozen peas

**Method:**

Place onion and garlic in 3-litre casserole dish. Cook on **P10** for 1 to 2 minutes. Add remaining ingredients, except mushrooms and peas. Stir until combined. Cover and cook on **P10** for 8 minutes. Stir and cook on **P4** for 28 to 30 minutes. Add mushrooms and frozen peas. Stir cook on **P4** for 14 to 15 minutes.

**SPAGHETTI MEAT SAUCE**

Serves: 4 to 6

**Ingredients:**

500 g	minced beef
1	onion, chopped
1 clove	garlic, minced
425 g	can tomatoes
1 cup	tomato paste
2	beef stock cubes
1 teaspoon	dried mixed herbs
	pepper

**Method:**

Combine all ingredients in a 3-litre casserole dish. Cook on **P10** for 7 minutes, stir. Cook on **P7** for 14 to 16 minutes. Stir halfway through cooking. Serve with spaghetti.

**BEEF STROGANOFF**

Serves: 4

**Ingredients:**

1	onion, sliced
1 clove	garlic, minced
750 g	rump steak sliced thinly
2 tablespoons	tomato sauce
2 tablespoons	worcestershire sauce
1	beef stock cube
1 teaspoon	paprika
1/3 cup	sour cream
200 g	sliced mushrooms

**Method:**

Place all ingredients (except sour cream and mushrooms) in a 3-litre casserole dish. Stir until combined. Cover and cook on **P7** for 7 to 9 minutes, stirring once during cooking. Add mushrooms. Stir and cook on **P7** for 4 to 5 minutes. Stir through sour cream.

**CHINESE BEEF AND VEGETABLES**

Serves: 4 to 6

**Ingredients:**

500 g	rump steak sliced
1 teaspoon	chopped ginger
1 clove	garlic, chopped
1 tablespoon	soy sauce
1/4 cup	Hoisin sauce
1/4 cup	sweet chilli sauce
3 cups	sliced vegetables

**Method:**

Place steak, ginger and garlic in a 3-litre casserole dish. Cook on **P10** for 1 minute. Add soy sauce, Hoisin sauce and chilli sauce to meat mixture. Cook on **P10** for 4 to 5 minutes. Add the vegetables, cover and cook on **P10** for 3 to 5 minutes, stirring halfway through cooking. Let stand for 5 minutes before serving.

**LAMB KORMA**

Serves: 4

**Ingredients:**

1	onion, diced
500 g	lamb, cubed
½ cup	korma curry paste
2	large carrots sliced
250 ml	tomato puree
250 ml	beef stock
2 tablespoons	natural yoghurt

**Method:**

Place onion, lamb, curry paste and carrot in a 3-litre casserole dish. Cook on **P10** for 6 minutes. Add tomato puree and beef stock and stir, cook on **P5** for 40 minutes, stirring once during cooking. Stir in yoghurt and serve with basmati rice.

**SEASONED ROAST LAMB**

Serves: 4 to 6

**Ingredients:**

1.4 kg	leg of lamb
1 tablespoon	seeded mustard
1 tablespoon	rosemary

**Method:**

Place lamb fat side down on rack set in a 3-litre dish. Brush with mustard and rosemary. Cook on **P6** for 30 to 35 minutes, turn halfway through cooking. Stand, covered, for 15 minutes before slicing.

**GOULASH**

Serves: 4

**Ingredients:**

1	onion, chopped
1	clove garlic, crushed
1 tablespoon	butter
2 tablespoons	tomato paste
1 teaspoon	paprika
500 g	lamb, diced
1	small capsicum, diced
1 cup	beef stock
2 tablespoons	flour
2 tablespoons	water
2 tablespoons	sour cream

**Method:**

Place onion, garlic and butter in 3-litre casserole dish. Cook on **P10** for 1 to 2 minutes. Add tomato paste and paprika. Cook on **P10** for a further 2 minutes. Add lamb, capsicum and stock. Cover and cook on **P6** for 25 to 30 minutes, stirring halfway through cooking. Mix flour with 2 tablespoons of water and stir into goulash mixture. Cook on **P10** for 1 to 2 minutes. Stir in sour cream and serve with pasta and rice.

**LAMB PILAU**

Serves: 4

**Ingredients:**

1	tablespoon	oil
1		large onion, sliced
600 g		lean lamb, diced
400 g		can tomato pieces
2 teaspoons		garam masala
1 teaspoon		dried thyme
1 cup		long grain rice
600ml		hot chicken stock
150 g		natural yoghurt
		freshly ground black pepper

**Method:**

Place the oil and onion in a 3 litre dish. Cover and cook on **P10** for 2 to 3 minutes. Add lamb, tomato pieces, garam masala, and thyme. Cover and cook on **P7** for 10 minutes. Stir. Cook on **P7** for a further 10 minutes. Add the rice and chicken stock and cook covered on **P5** for a further 30 minutes or until the rice is tender. Stir in yoghurt, season with pepper and serve.

**GINGERED PORK STIR FRY**

Serves: 4

**Ingredients:**

500 g	sliced lean pork
¼ cup	teriyaki sauce
1 tablespoon	honey
2 teaspoons	minced ginger
2 teaspoons	cornflour
1	onion, sliced
300 g	sugar snap peas, trimmed
1	zucchini, sliced
½	red capsicum, sliced
2	green onions, sliced
½ cup	bean sprouts
1 tablespoon	toasted sesame seeds

**Method:**

Place pork, teriyaki sauce, honey, ginger and cornflour in a 2-litre dish. Cover and marinate in the refrigerator for 2 hours. Place onion in a 3 litre dish. Cook on **P10** for 1 to 2 minutes. Add marinated pork and sauces and cook on **P7** for 3 to 4 minutes. Add peas, zucchini, capsicum, green onions and bean sprouts. Cook on **P10** for 3 to 4 minutes. Sprinkle with sesame seeds and serve with noodles.

**HINT:**

It is better to cook meat for a lesser time in a recipe and add extra time if needed. This will prevent over cooking.

### Cooking Fresh Vegetables By Micro Power

Place vegetables in a casserole dish. Add 2 to 3 tablespoons of water per 500 g of vegetables. Add salt to water or add after cooking. Do not place salt directly on vegetables. Cover dish with glass lid or plastic wrap. Cook on **P10** according to time recommended in charts. Halfway through cooking, stir, turn vegetables over or rearrange.

Vegetables that are to be cooked whole and unpeeled, need to be pierced to allow steam to escape. Place vegetables on a paper towel lined dinner plate. Allow to stand, covered, according to the time indicated in the charts.

### Cooking Fresh Vegetables by Micro Power

Vegetables should be covered and cooked on **P10** power for best results. Weights given are trimmed weights.

VEGETABLE	QUANTITY	COOKING PROCEDURE	APPROX. COOKING TIME (in minutes) on P10
Asparagus	250 g	Covered dish with 60 ml water	1 to 3
Beans (finely sliced)	250 g	Covered dish with 60 ml water	3 to 5
Beetroot	4 whole (1 kg)	Covered with 250 ml water in 4-litre dish. Stand after cooking - 5 mins.	14 to 18
Broccoli	250 g	Covered dish with 60 ml water.	4 to 6
Brussels Sprouts	250 g	Covered dish with 60 ml water.	4 to 6
Cabbage	500 g	Shredded, with 60 ml water in covered dish.	5 to 7
Carrots	4 (sliced finely) 250 g	With 60 ml water in covered dish.	5 to 6
Cauliflower	500 g	With 60 ml water in covered dish.	6 to 8
Celery	6 stalks (400 g) cut in 1 cm pieces	With 60 ml water in covered dish.	4 to 6
Corn	2 cobs (500 g) 4 cobs (1 kg)	Brush with melted butter and cook in covered dish.	4 to 6 10 to 12
Eggplant	1 (500 g)	Dice with 60 ml water in covered dish.	4 to 6
Mushrooms	250 g (sliced)	Cook with 40 ml butter in covered dish.	2 to 4
Onions	3 (200 g)	Cut in quarters with 60 ml water in covered dish.	5 to 7
Peas	250 g	Shell peas and place with 60 ml water in covered dish.	3 to 5
Potatoes-Mashed -Jacket	500 g 3 Med	Peeled and quartered with 60 ml water. Covered. Cook uncovered on paper towel lined plate.	8 to 10 7 to 9
Pumpkin	500 g	Peeled and cut into uniform pieces with 60 ml water in covered dish.	7 to 9
Spinach/Silver Beef	250 g	Remove stem, cut leaves into small pieces. Cook with 60 ml water in covered dish.	4 to 6
Sweet Potato	500 g	In serving size pieces with 40 ml water in covered dish.	7 to 9
Turnips	500 g	Peeled and sliced finely with 60 ml water in covered dish.	6 to 8
Tomatoes	2 (300 g)	Sliced and cooked covered.	2 to 4
Zucchini	500 g	Cut in 2 cm pieces in covered dish.	5 to 7

### Cooking Frozen Vegetables By Micro Power

Remove vegetables from package and place in an appropriate sized container. Vegetables frozen in a pouch should be placed on a dish and the top pierced. Cook on **P10** according to directions given in chart. Vegetables should be cooked covered with a lid or plastic wrap.

Halfway through cooking, stir, turn vegetables over or rearrange. Stir after cooking. Allow to stand for 2 to 3 minutes before serving.

#### Cooking Frozen Vegetables by Micro Power

VEGETABLE	QUANTITY	COOKING PROCEDURE	APPROX. COOKING TIME (in minutes) on P10
Beans	250 g	Cook in covered 2-litre dish.	4 to 6
Broad Beans	250 g	Cook in covered 2-litre dish.	5 to 7
Broccoli (spears)	350 g	Cook in covered 2-litre dish.	5 to 7
Brussels Sprouts	250 g	Cook in covered 2-litre dish.	5 to 7
Carrots (baby)	250 g	Cook in covered 2-litre dish.	6 to 8
Cauliflower	500 g	Cook in covered 2-litre dish.	5 to 7
Corn (½ cob)	125 g	Cook in covered 2-litre dish.	3 to 4
Corn (cobs)	250 g	Cook in covered 2-litre dish.	5 to 7
Mixed Vegetables	250 g	Cook in covered 2-litre dish.	5 to 7
Peas	250 g	Cook in covered 2-litre dish.	4 to 6
Spinach	250 g	Cook in covered 2-litre dish.	4 to 6

### Cooking Dried Beans and Peas by Micro Power

Place hot tap water in 4-litre dish. Bring hot water to the boil on High for 10 to 12 minutes. Add beans and 2 tablespoons oil to water. Cook according to directions in chart. Stir. Allow to stand, covered, for 15 to 20 minutes.

**Note:** Beans such as red kidney beans and lima beans should be soaked overnight before cooking. 250 g of dried beans equals about 3 cups cooked beans. Use in place of canned beans.

#### Cooking Dried Beans and Peas by Micro Power

ITEM	CONTAINER	AMOUNT OF HOT WATER	APPROX. TIME TO BOIL HOT WATER on P10 (in minutes) COVERED	TO COOK BEANS on P3 (in minutes) COVERED
Lentils (250 g)	4-litre dish	2 litres	10 to 12	15 to 20
Soup Mix (250 g)	4-litre dish	2 litres	10 to 12	20 to 25
Split Peas or Lentils (250 g)	4-litre dish	2 litres	10 to 12	25 to 30
Beans (250 g) Soaked overnight	4-litre dish	2 litres	10 to 12	25 to 30

**POTATO BAKE**

Serves: 4 to 6

**Ingredients:**

750 g	peeled and sliced potatoes
300 ml	cream
¼ cup	milk
3	green onions, sliced
2	bacon rashers, chopped
½ cup	grated cheese

**Method:**

Combine potatoes, cream and milk in 2-litre casserole dish. Cook on **P10** for 15 to 18 minutes. Top with green onions, bacon and cheese. Cook on **P10** for 5 minutes.

**VEGETABLE FRITTATA**

Serves: 4 to 6

**Ingredients:**

400 g	potatoes, thinly sliced
½	red capsicum, sliced into strips
½	green capsicum, sliced into strips
1	tomato, diced
2 tablespoons	fresh basil, chopped
4	eggs
⅓ cup	sour cream
½ teaspoon	cracked black pepper
½ cup	grated tasty cheese

**Method:**

Place potatoes in a 2-litre shallow dish. Cook on **P10** for 5 to 7 minutes. Arrange capsicum in a circular pattern on top of potato sprinkle with tomato and basil. Beat together eggs and sour cream in a jug. Pour over vegetables. Cook on **P6** for 3 to 5 minutes. Sprinkle with pepper and cheese and cook on **P6** for 7 to 9 minutes.

**ARDENNIS STYLE POTATOES**

Serves: 4

**Ingredients:**

4	medium sized potatoes
100 g	ham, finely diced
3 tablespoons	snipped chives
50 g	butter
½ cup	grated Cheddar cheese
	ground black pepper

**Method:**

Scrub potatoes, wash and pat dry with paper towel. Prick skins and place on a dinner plate. Cook on **P10** for 6 to 8 minutes. Allow to cool slightly. Cut tops off potatoes and scoop out pulp from centre, leaving 1 to 2 cm in shell. Mash pulp and combine with remaining ingredients. Spoon filling back into potato shells. Place potatoes in 2-litre casserole dish. Cook on **P10** for 2 to 3 minutes.

**CREAMED SPINACH**

Serves: 4

**Ingredients:**

1	bunch spinach, roughly chopped
4	green onions, finely chopped
1	clove garlic, crushed
2 tablespoons	sour cream
	salt and pepper

**Method:**

Cook washed spinach leaves, green onions and garlic in a covered 3-litre casserole dish on **P10** for 5 to 7 minutes. Drain well by squeezing between two dinner plates. Stir through sour cream. Season to taste. Cook on **P10** for 1 to 2 minutes. Serve.

## CAULIFLOWER AU GRATIN

Serves: 4

### Ingredients:

500 g	trimmed cauliflower and cut into pieces
2 tablespoons	water
2 tablespoons	butter
2 tablespoons	flour
1 cup	milk
¼ cup	grated tasty cheese

### Method:

Place cauliflower and water in a shallow casserole dish. Cover and cook on **P10** for 6 to 8 minutes. Stand, covered, while making sauce. Place butter in a 4-cup glass jug. Cook on **P10** for 1 to 2 minutes. Stir in flour and cook on **P10** for 1 minute. Add milk gradually. Stir well. Cook on **P10** for 2 to 3 minutes, stirring halfway through cooking. Drain cauliflower and pour over sauce. Sprinkle with cheese. Cook on **P7** for 1 to 2 minutes.

**Note:** Depending on size and arrangement of cauliflower pieces, timing will vary.

## THAI VEGETABLE CURRY

Serves: 4

### Ingredients:

1	onion, sliced
2 tablespoons	green curry paste
3 cups	sliced vegetables
440 g	chick peas, drained
1 cup	coconut milk
1 tablespoon	lemon juice
1 tablespoon	soy sauce
½ cup	chopped nuts

### Method:

Place onion and curry paste in a 3-litre casserole dish. Cook on **P10** for 2 minutes. Add vegetables, chick peas, coconut milk, lemon juice and soy sauce. Cook on **P10** for 6 to 8 minutes. Sprinkle with chopped nuts. Serve with jasmine rice.

## HERBED VEGETABLES

Serves: 4 to 6

### Ingredients:

200 g	sliced snow peas
200 g	sliced carrots
200 g	sliced zucchini
2 tablespoons	chopped fresh parsley

### Method:

Place snow peas, carrots and zucchini in a 2-litre casserole dish. Cover. Cook on **P10** for 4 to 6 minutes, stirring once during cooking. Sprinkle with parsley. Serve.

## TOMATO VEGETABLE CASSEROLE

Serves: 4 to 6

### Ingredients:

200 g	mushrooms, sliced
1	eggplant, chopped
200 g	zucchini, sliced
1	capsicum, sliced
1	onion, sliced
400 g	can tomatoes
½ cup	tomato paste
1 tablespoon	chopped basil
1 clove	garlic, minced

### Method:

Place mushrooms, eggplant, zucchini, capsicum and onion in a 3-litre casserole dish. Cover. Cook on **P7** for 10 minutes. Add tomatoes, tomato purée, herbs and garlic. Re-cover and cook on **P10** for 8 to 10 minutes.

Add remaining ingredients. Cover with plastic wrap. Cook on **P10** for 8 to 10 minutes.

### HINT:

It is better to slightly undercook vegetables as they will soften on standing. Allow to stand, covered, with plastic wrap or a lid.

### HINT:

Wrap jacket potatoes in foil after cooking. They will retain their heat for about 15 to 20 minutes.

### HINT:

**TO SKIN TOMATOES:** Cut a cross into the tomato skin. Place 1 cup of hot tap water in a 2 cup jug or bowl and heat on **P10** for 1½ minutes or until boiling. Add 1 tomato and heat for a further 20 to 30 seconds. Remove and repeat procedure with remaining tomatoes. The skin will loosen and can be easily removed.



**SAVOURY BRUSSELS SPROUTS**

Serves: 4

**Ingredients:**

250 g	brussels sprouts
1 tablespoon	butter
150 g	bacon, finely chopped
1	onion, finely chopped
1 teaspoon	dill or basil
1 teaspoon	sugar

**Method:**

Wash and drain brussels sprouts. Cook in a covered 2-litre casserole dish on **P10** for 4 to 5 minutes. Drain and set aside. Place remaining ingredients in separate 1-litre casserole dish. Cook on **P10** for 3 to 5 minutes. Add brussels sprouts and cook on **P10** for 1 to 2 minutes. Serve.

**HONEY GLAZED CARROTS AND SUGAR SNAP PEAS**

Serves: 4 to 6

**Ingredients:**

350 g	carrots
150 g	sugar snap peas, trimmed
2 tablespoons	brown sugar
2 teaspoons	butter
2 tablespoons	honey
1 tablespoon	toasted sesame seeds

**Method:**

Peel and thinly slice carrots. Combine all ingredients in a 2-litre casserole dish. Cover and cook on **P10** for 5 to 7 minutes, stirring halfway through cooking. Serve.

**PARMESAN ASPARAGUS**

Serves: 2 to 4

**Ingredients:**

1	bunch of asparagus spears
2 tablespoons	water
1 tablespoon	butter
1	clove garlic, crushed
1 tablespoon	grated Parmesan cheese

**Method:**

Place asparagus and water in a 2-litre casserole dish. Cover and cook on **P10** for 1 to 2 minutes. Drain. Place butter and garlic in a small dish and cook on **P10** for 1 minute. Add drained asparagus and mix lightly. Cook on **P10** for a further 1 minute. Sprinkle Parmesan cheese over asparagus. Serve.

**Tip:**

When placing asparagus in dish, place half the tips one way and half the tips in the opposite direction for more even cooking.

**RED COCONUT DHAL**

Serves: 4 to 6

**Ingredients:**

1 cup	red lentils
1 teaspoon	turmeric
400 ml	coconut milk
250 ml	water
1 teaspoon	crushed red chilli
1 teaspoon	crushed garlic
	lemon juice to taste

**Method:**

Place all ingredients in a 2 litre casserole dish. Stir and cook on **P6** for 18 to 20 minutes, stirring twice during cooking.

## HUMMUS

### Ingredients:

1 cup	chick peas, water for soaking
750 ml	boiling water
2 tablespoons	lemon juice
2 teaspoons	turmeric
¼ cup	tahini ( sesame paste )
4 cloves	garlic, minced
2 tablespoons	olive oil

### Method:

Place chickpeas and water into a 4-litre casserole dish and soak overnight. Drain.

Place chickpeas and boiling water into a 3-litre casserole dish and cook on **P6** for 25 to 30 minutes. Drain, process with remaining ingredients.

## CHICKPEA SALAD WITH CORIANDER

### DRESSING

Serves: 4 to 6

### Ingredients:

1 cup	dried chickpeas, water for soaking
3 cups	boiling water
1	red capsicum, diced
1	lebanese cucumber, diced
250 g	cherry tomatoes, quartered
1	spanish onion, diced

### Coriander Dressing:

½ cup	lemon juice
2 teaspoons	sugar
½ cup	chopped fresh coriander
1 teaspoon	chopped red chilli

### Method:

Cover chickpeas with water and soak overnight. Drain. Place chickpeas and boiling water into a 3-litre dish and cook on **P7** for 25 to 30 minutes. Drain and allow to cool.

Combine remaining salad ingredients in a large bowl and mix well.

### Dressing:

Combine all ingredients in a screw top jar, shake well. Pour over salad and toss well.

## LENTIL HOT POT

Serves: 4 to 6

### Ingredients:

900 g	new potatoes
2	onions, diced
2	carrots, diced
2	stalks celery, sliced
3	cloves garlic, crushed
1 teaspoon	curry powder
400 g	can diced tomatoes
1 cup	vegetable stock
2 tablespoons	tomato paste
¾ cup	red lentils, washed
½ cup	grated cheese
	paprika
1 tablespoon	chopped parsley

### Method:

Wash potatoes and place onto a paper towel lined plate. Cook on **P7** for 8 to 10 minutes.

Set aside. Place onion, carrot, celery and garlic into a 3 litre dish. Cook on **P7** for 7 to 8 minutes. Add curry powder and cook on **P7** for a further 1 minute. Add tomatoes, stock, tomato paste and lentils. Cook on **P7** for 20 to 24 minutes, stirring halfway through cooking. Slice potatoes thickly and layer over the top of lentil mixture. Sprinkle with grated cheese, paprika and parsley. Cook on **P10** for 4 to 6 minutes.

### Cooking Rice by Micro power

Follow directions in chart for recommended dish size, amounts of water and cooking time. Add rice to water. Add salt and butter according to package directions. Cook on **P10** for time recommended in chart. Allow to stand, covered, before serving. For special rice, substitute beef or chicken stock for water. Add cooked onion, mushrooms or crumbled bacon before serving.

ITEM	CONTAINER	AMOUNT OF WATER	APPROX. TIME TO COOK GRAIN on P10 UNCOVERED (in minutes)	STANDING TIME (in minutes)
RICE Quick Cook Brown (1 cup)	2-litre dish	1½ cups	10	5
Brown (1 cup)	3-litre dish	3 cups	25 to 30	10
Long Grain (1 cup)	2-litre dish	2 cups	12 to 14	5
Short Grain (1 cup)	2-litre dish	2 cups	12 to 14	5
Jasmine (1 cup)	3-litre dish	2 cups	12 to 14	5

### Cooking Pasta by Micro Power

Follow directions in chart for recommended dish size, amount of water and cooking time. Boil water, with 1 teaspoon salt and 1 tablespoon oil. Add pasta and cook for time recommended in chart. Cook on **P10**. Test pasta for desired cooking before adding more time. Slightly undercook pasta that will be heated again in casserole. Stir and let stand, uncovered, 5 minutes.

ITEM	CONTAINER	AMOUNT OF BOILING WATER	APPROX. TIME TO COOK GRAIN on P10 UNCOVERED (in minutes)	STANDING TIME (in minutes)
Dried Fettuccine (250 g)	4-litre dish	6 cups	10 to 12	5
Elbow Macaroni, shells, etc. (250 g)	3-litre dish	4 cups	12 to 14	5
Fresh Spaghetti, Fettuccine (375 g)	4-litre dish	6 cups	6 to 8	5
Dried Spaghetti (250 g)	4-litre dish	4 cups	12 to 14	5
Fresh Tortellini, Ravioli (250 g)	4-litre dish	4 cups	7 to 9	5
Fresh Gnocchi (375 g)	4-litre dish	6 cups	6 to 8	5

### Cooking Dried Noodles by Micro Power

Follow directions in chart recommended dish size, amount of water and cooking time. Add 1 tablespoon of oil to water to prevent noodles from sticking together. Add noodles and cook for time recommended in chart. Cook noodles on **P10**. Test noodles for desired cooking before adding extra time. Slightly undercook noodles that will be cooked again in a stir-fry or recipe. Always drain noodles immediately after cooking or they may overcook on standing.

ITEM	CONTAINER	AMOUNT OF BOILING WATER	APPROX. TIME TO COOK GRAIN on P10 UNCOVERED (in minutes)	INSTRUCTION
2 minutes noodles (85 g)	1-litre	500 ml	2 to 3	drain immediately
Long Life Asian Noodles (250 g)	3-litre	1 litre	5 to 6	drain immediately
Rice Vermicelli (125 g)	2-litre	1 litre	3 to 4	drain immediately

## PAELLA

Serves: 6 to 8

### Ingredients:

500 g	mussels
60 ml	water
1	green capsicum, sliced
1	red capsicum, sliced
1	onion, sliced
1 clove	garlic, crushed
2 tablespoons	butter
2 cups	long grain rice
400 g	can peeled tomatoes, chopped
500 ml	hot chicken stock
	pinch saffron powder
1½ cups	cooked diced chicken
200 g	peeled green prawns

### Method:

Place mussels and water in a 3-litre dish. Cover and cook on **P7** for 3 to 5 minutes. Set aside. Place capsicum, onion, garlic and butter into 4-litre dish and cook on **P10** for 4 to 5 minutes. Add rice and stir well. Cook on **P10** for 2 to 4 minutes. Stir in tomatoes, hot chicken stock and saffron. Cook on **P10** for 16 to 18 minutes. Stir in chicken, prawns and mussels. Cook on **P7** for 4 to 6 minutes. Stand for 10 minutes before serving.

## FRAGRANT COCONUT RICE

Serves: 4 to 6

### Ingredients:

1	onion, chopped
2 cups	long grain rice
500 ml	chicken stock
400 ml	coconut milk
1 teaspoon	turmeric

### Method:

Place all ingredients in a 3-litre casserole dish. Stir. Cook on **P10** for 15 to 18 minutes. Cover and let stand 10 minutes before serving.

## SEASONED RICE

Serves: 4 to 6

### Ingredients:

1	onion, chopped
1 cup	long grain rice
1 teaspoon	thyme
375 ml	chicken stock
¼ cup	toasted slivered almonds

### Method:

Place onion, rice, thyme and chicken stock in a 3-litre casserole dish. Cook on **P10** for 14 to 16 minutes. Stir, cover, and let stand for 10 minutes. Stir through slivered almonds and serve hot.

## FRIED RICE

Serves: 4

### Ingredients:

1 tablespoon	sesame oil
1	clove garlic, crushed
1 cm	piece of green ginger, finely chopped
1	small carrot, finely chopped
1	stick celery, sliced
½	green or red capsicum, cut in strips
2	eggs
4	green onions, chopped
	black pepper
1	small can prawns
1 tablespoon	soy sauce
6 cups	cooked rice

### Method:

Place oil, garlic and ginger in a large shallow dish and cook on **P10** for 30 to 40 seconds. Add carrot, celery and capsicum. Cook a further 2 minutes on **P10**. Break eggs into a small dish, add pepper to taste, mix well and cook on **P7** for 1 to 1½ minutes. Slice into thin strips. Add eggs plus all remaining ingredients to vegetable mixture. Stir well and cook on **P10** for 3 to 5 minutes to heat thoroughly. Serve.

### Notes:

- 1 cup uncooked rice will yield 2 cups cooked rice.
- Cooked rice can be cooked using Sensor Cook functions.

### HINT:

**TO REHEAT 2 CUPS OF COOKED RICE:**  
Add 1 to 2 tablespoons of water or a knob of butter and cook on **P10** for 2 to 3 minutes.

**CHICKEN RISOTTO**

Serves: 4

**Ingredients:**

1	onion, sliced
2 cups	short grain rice
1 teaspoon	dried oregano
1 teaspoon	cracked black pepper
1 L	chicken stock
¼	green capsicum, sliced
¼	red capsicum, sliced
200 g	mushrooms, sliced
½ cup	frozen peas
2	cooked chicken breast fillets, sliced
¼ cup	grated parmesan cheese

**Method:**

Place onion, rice, oregano, pepper and chicken stock into a 4-litre dish. Cook on **P10** for 17 to 19 minutes. Add remaining ingredients, stir well and cook on **P10** for 4 minutes. Serve.

**PENNE PUTTANESCA**

Serves: 4

**Ingredients:**

500 g	Penne Pasta
2 L	boiling water
1 tablespoon	olive oil
3	cloves garlic, crushed
1 teaspoon	dried chilli flakes
1 kg (approx 5)	tomatoes, roughly chopped
200 g	kalamata olives, pitted
8	anchovy fillets, drained and chopped
⅓ cup	capers, drained and rinsed
⅓ cup	flat leaf parsley, chopped
2 tablespoons	finely shredded basil leaves

**Method:**

Place pasta and boiling water into a 4-litre dish. Stir and cook on **P10** for 12 to 14 minutes or until tender. Drain and set aside. Place oil and garlic into a 2 litre dish and cook on **P10** for 1 minutes. Stir in chilli and tomatoes. Cover and cook on **P10** for 5 minutes, stir halfway through cooking. Add remaining ingredients and cook on **P10** for a further 10 minutes or until tomatoes break down and sauce has thickened. Stir sauce into pasta. Cover and cook on **P10** for 2 to 3 minutes to heat through. Season and serve topped with extra basil leaves or parsley.

**CREAMY SUN-DRIED TOMATO PENNE**

Serves: 4

**Ingredients:**

250 g	penne
1½ L	boiling water
½ cup	sun-dried tomatoes in oil, drained
1 cup	basil leaves
¼ cup	toasted pinenuts
⅓ cup	grated parmesan cheese
300 ml	cream
½ cup	sliced ham
¼ cup	grated parmesan cheese, extra

**Method:**

Place pasta and water in a 4-litre casserole dish. Cook on **P10** for 14 to 16 minutes.

While pasta is cooking, prepare sauce. Place all ingredients except ham and extra parmesan cheese into a food processor. Process until smooth. Drain pasta and add sauce. Serve topped with ham and extra parmesan cheese.

**Tip:**

To toast ¼ cup pinenuts place into a small bowl. Cook on **P10** for 3 to 4 minutes, stirring every minute.

**SPAGHETTI WITH CHILLI TOMATO SAUCE**

Serves: 4

**Ingredients:**

250 g	spaghetti
4 cups	boiling water
1 tablespoon	olive oil
1	onion, finely chopped
2	cloves garlic, crushed
425 g	can crushed tomatoes
2 teaspoons	crushed chillies
2 tablespoons	fresh chopped basil
1 teaspoon	pepper

**Method:**

Place spaghetti and water in a 3-litre casserole dish. Cook on **P10** for 12 to 14 minutes.

Stand, covered, for 2 minutes. Drain. Place oil, onion and garlic in a 4-cup jug. Cook on **P10** for 1 to 2 minutes. Add tomatoes, chillies, basil and pepper. Stir until combined. Cover and cook on **P7** for 10 to 15 minutes, stirring halfway through cooking. Serve with spaghetti.

## CREAMY BACON SAUCE

Makes: Approximately 300 ml

### Ingredients:

1	onion, chopped
3	bacon rashers, chopped
1 teaspoon	minced garlic
300 ml	cream
¼ cup	Parmesan cheese
	pepper
2 tablespoons	chopped fresh parsley

### Method:

Place onion, bacon and garlic in a 2-litre casserole dish. Cook on **P10** for 4 to 5 minutes. Add cream, Parmesan cheese, pepper, parsley. Mix well. Cook on **P10** for 3 to 4 minutes. Serve with cooked Fettuccine.

## MACARONI AND CHEESE

Serves: 4 to 6

### Ingredients:

40 g	butter
1	onion, finely chopped
2 tablespoons	flour
2 cups	milk
1 cup	grated tasty cheese
6 cups	cooked macaroni, drained well
½ cup	extra grated tasty cheese
	paprika

### Method:

Place butter and onion in a 2-litre casserole dish and cook on **P10** for 3 to 5 minutes. Add flour, mix well and cook on **P10** for 1 minute. Blend in milk and cook on **P10** for 4 to 5 minutes, stirring halfway through cooking. Add cheese to sauce and season. Place macaroni and sauce in a 3-litre casserole dish. Mix well. Top with extra cheese and sprinkle with paprika. Cook on **P10** for 6 to 8 minutes.

## SZECHUAN SALAD NOODLES

### Ingredients:

350 g	fresh Hokkien noodles
125 ml	boiling water
250 g	cooked chicken, shredded
½ cup	roasted cashew nuts

### Dressing:

4	green onions, finely sliced
2 tablespoons	chopped coriander
2	cloves garlic, minced
2 tablespoons	smooth peanut butter
2 tablespoons	sweet chilli sauce
1 tablespoon	soy sauce
1 tablespoon	sweet sherry
2 teaspoons	sesame oil
2 tablespoons	olive oil
2 tablespoons	chicken stock
10	toasted szechuan peppercorns, ground

### Method:

Place noodles in a bowl with the boiling water. Cook on **P7** for 1 to 2 minutes. Drain and rinse under cold water. Drain well. Combine all dressing ingredients and whisk well. Combine noodles, chicken and cashew nuts and pour over dressing. Toss well to combine. Serve immediately.

## TERIYAKI TOFU VEGETABLE NOODLES

Serves: 4

### Ingredients:

1 tablespoon	sesame oil
350 g	firm tofu, diced
1	onion, cut into petals
300 g	stir fry vegetables
1 tablespoon	hoisin sauce
1 tablespoon	teriyaki sauce
85 g	2 minute noodles
2 cups	boiling water

### Method:

Place oil, tofu and onion in a 3-litre dish and cook on **P10** for 2 to 3 minutes. Add vegetables and sauces and cook on **P10** for 3 to 4 minutes, stirring once during cooking. Place noodles and water in a 2-litre bowl and cook on **P10** for 2 minutes. Stir and drain. Toss noodles through tofu and vegetables and serve.

Cakes, Desserts and slices can successfully be cooked in the microwave oven if a few simple rules are followed see individual recipes for instructions.

### COOKING CAKES BY MICRO POWER

- The texture of cakes cooked in the microwave oven is not the same as cakes cooked in a conventional oven, but it is a convenient way of cooking cakes.
- Do not use metal cake tins, plastic dishes and pyrex, give the best results when cooking cakes. Grease the dish and line with paper towel or bake paper to absorb excess moisture.
- Round or oval shaped dishes produce the most even cooking results. Square cakes may need the corners shielded with foil to prevent overcooking.
- Choose light coloured cakes that can be iced or substitute brown sugar for white sugar and sprinkle the top of cake with spices to give a darker appearance.
- Do not fill cake pans more than half full. Microwaved cakes rise substantially more than conventionally cooked cakes.
- Cakes need to be well mixed but do not over beat. Creaming with an electric mixer or food processor is not necessary. Use a fork to mix as the microwave aerates the mixture as it cooks.
- Do not cover cakes as the top will steam.
- Cakes should be removed from the oven just before they look cooked as the cooking process will finish during standing time.
- Chocolate cakes cook slightly faster than plain cakes.
- Cakes containing a large amount of whisked egg white will not cook successfully in the microwave oven.

### COOKING FRUIT BY MICRO POWER

FRUIT - Peel, slice, chop into even sized pieces. Place in shallow heatproof dish on turntable.				
Apples - poached	500 g	P10	8	Add 300 ml of water. Only half fill dish. Cover.
Apples - stewed	500 g	P10	6	Only half fill dish. Cover.
Peaches - poached	500 g	P10	4 - 5	Add 300 ml of water. Only half fill dish. Cover.
Pears - poached	500 g	P10	6 - 7	Add 300 ml of water. Only half fill dish. Cover.
Plums - poached	500 g	P10	8	Add 300 ml of water. Only half fill dish. Cover.
Plums - stewed	500 g	P10	8 - 10	Add 30 ml (2 tablespoons) of water. Only half fill dish. Cover.
Rhubarb - stewed	500 g	P10	5	Only half fill dish. Cover.

#### SULTANA CAKE

Serves: 4 to 6

##### Ingredients:

100 g	butter
1 cup	sultanas
1 cup	brown sugar
1 cup	milk
1	egg, beaten
2 cups	self-raising flour

##### Method:

Place butter, sultanas, brown sugar and milk in heat resistant mixing bowl. Cook on **P10** for 3 to 4 minutes. Stir halfway through cooking. Allow to cool. Add egg and flour. Pour batter into base of lined 20 cm round dish. Cook on **P6** for 9 to 11 minutes. Let cool, loosely covered, with plastic wrap on wire rack.

#### QUICK MIX CHOCOLATE CAKE

Serves: 4 to 6

##### Ingredients:

1 cup	self-raising flour
1 cup	caster sugar
2 tablespoons	cocoa
3 tablespoons	butter, softened
2	eggs
1/3 cup	milk

##### Method

Sift all dry ingredients into a bowl. Add butter, eggs and milk. Beat with wire whisk for 1 to 2 minutes. Grease 2-litre plastic ring mould and line with paper towel. Pour mixture into mould and cook on **P7** for 5 to 7 minutes. Stand, covered, for 5 minutes before turning out. Cool on wire rack.

**Tip:** To soften butter cook on **P5** for 10 to 20 seconds.

**PACKET CAKE****Ingredients:**

1 packet cake mix (340 g)  
 Ingredients as recommended by manufacturer.

**Method:**

Mix cake and other ingredients with a metal spoon. **DO NOT OVERBEAT.** Pour into 20 cm round dish that has been lightly greased and lined with paper. Cook on **P8** for 5 to 7 minutes. Stand and allow to cool before removing.

**Variations:**

- 1 tablespoon jam added to batter before cooking.
- Add 1 cup sour cream to batter and halve water suggested by manufacturer.
- Half a cup chopped nuts, ¼ cup brown sugar and 1 teaspoon cinnamon. Mix and place on base of cake dish before cooking cake.
- Melt two tablespoons honey and 30 g butter in glass jug on **P10** for 30 to 60 seconds. Pour over just baked buttercake. Sprinkle with cinnamon.
- Serve warm with cream or custard as a dessert or serve cold with cream as tea cake.
- A quarter cup of toasted muesli mixed with 1 tablespoon marmalade and placed in the base of the dish.

**Tip:** Packet cakes are best mixed by hand as the microwave will do the aerating.

**CHOCOLATE SELF SAUCING PUDDING**

Serves: 4

**Ingredients:**

1 cup	self raising flour
1 tablespoon	cocoa powder
½ cup	caster sugar
½ cup	milk
1 teaspoon	vanilla essence
100 g	chocolate
30 g	butter
¾ cup	brown sugar
2 tablespoons	cocoa, extra
¾ cup	water

**Method:**

Sift flour and cocoa into a 2-litre bowl. Add sugar, milk and vanilla essence. Mix well. Place chocolate and butter in a 2-cup pyrex jug and cook on **P7** for 1 to 1½ minutes. Stir and add to mixture. Mix well. Spread mixture into base of a 2-litre casserole dish. Combine brown sugar, cocoa and water in 2-cup jug. Pour evenly over pudding. Cook on **P10** for 4 to 6 minutes.

**HINT:****TO MELT CHOCOLATE:**

Place 100 g broken chocolate in a 4-cup glass jug and heat on **P5** for 1 to 2 minutes. As chocolate holds its shape after heating, stir and stand before adding extra cooking time.

**APPLE CRUMBLE**

Serves: 4

**Ingredients:**

1 (780 g)	can pie apples
½ cup	rolled oats
¼ cup	plain flour
½ cup	desiccated coconut
½ cup	brown sugar
1 teaspoon	cinnamon
60 g	butter

**Method:**

Place apples in the base of a 1-litre casserole dish. Place remaining ingredients (except butter) in mixing bowl. Melt butter in 2-cup jug on **P10** for 40 to 60 seconds. Combine melted butter with dry ingredients and mix well. Spread evenly over apples. Cook on **P10** for 5 to 8 minutes.

**PEACH AND MUESLI CRUMBLE**

Serves: 6 to 8

**Ingredients:**

80 g	butter
½ cup	flour
¼ cup	caster sugar
1½ cups	toasted muesli
½ cup	shredded coconut
½ teaspoon	cinnamon
810 g	peach slices, drained

**Method:**

Place butter in a 2-litre jug. Cook on **P7** for 1 minute. Add flour, sugar, muesli, coconut and cinnamon, stir until combined. Place peaches into a 1-litre casserole dish. Place crumble mixture on top of peaches and cook on **P10** for 10 to 12 minutes. Serve with cream or ice cream.



### APRICOT COBBLER

Serves: 4 to 6

**Ingredients:**

1 (810 g)	can apricot halves, drained
1 (340 g)	packet butter cake mix
½ cup	toasted coconut
70 g	butter, melted

**Method:**

Arrange apricot halves on the base of 20 cm casserole dish. Combine cake mix, toasted coconut and butter. Sprinkle cake mixture over peaches. Cook on **P10** for 6 to 8 minutes.

### SWEET BERRY SAUCE

Makes: Approximately 2 cups

**Ingredients:**

½ cup	caster sugar
125 ml	water
500 g	berries, halved if large
2 tablespoons	water
1 tablespoon	cornflour

**Method:**

Combine sugar and water in a 3-litre bowl. Cook on **P10** for 2 to 3 minutes. Add berries. Cook on **P10** for 3 to 4 minutes. Blend water and cornflour. Mix into berry sauce. Cook on **P10** for 2 minutes. Serve hot or cold with ice cream.

### CINNAMON POACHED PEARS

Serves: 4

**Ingredients:**

125 ml	water
½ cup	caster sugar
½ teaspoon	cinnamon
4	pears, peeled and sliced

**Method:**

Combine water, caster sugar and cinnamon in a 1-litre jug. Cook on **P10** for 2 minutes. Place the pears in a 2-litre dish. Pour over syrup and cover. Cook on **P10** for 6 to 8 minutes.

**Tip:**

To soften butter cook on **P5** for 10 to 20 seconds.

### FIGS IN RIESLING AND HONEY

Serves 4

**Ingredients:**

8	firm figs
1½ cups	Riesling wine
80 ml	honey
1 teaspoon	lemon juice
1 teaspoon	grated lemon rind
2 tablespoons	chopped pistachio nuts

**Method:**

Wash and stem the figs place into a 2 litre dish. Combine Riesling, and honey and pour over figs. Cook on **P7** for 6 to 8 minutes. Remove figs from syrup, set aside. Add lemon juice and rind to syrup and cook on **P10** for 3 to 4 minutes or until slightly reduced. Pour syrup over figs and allow to cool. Serve with ice cream or cream and sprinkle with pistachio nuts.

### FRUIT MINCE

Serves: 4

**Ingredients:**

250 g	mixed dried fruit
400 g	can crushed pineapple and juice
1	cooking apple peeled, cored and grated
1 cup	brown sugar
1 tablespoon	brandy
1 teaspoon	nutmeg
1 teaspoon	cinnamon
1 tablespoon	cornflour
60 ml	water

**Method:**

Combine all ingredients (except cornflour and water) in a 2-litre casserole dish. Cook on **P7** for 3 to 5 minutes. Blend cornflour with water and stir into fruit mixture. Cook on **P10** for 3 to 5 minutes. Stir. Cool. Bottle and seal or use immediately.

## INDIVIDUAL CHRISTMAS PUDDING

Makes: 8

### Ingredients:

100 g	sultanas
150 g	raisins
50 g	craisins
100 g	dates, chopped
100 g	dried figs, chopped
50 g	glace ginger, chopped
½ cup	brandy
125 g	butter
¾ cup	firmly packed brown sugar
2	eggs
½ teaspoon	cinnamon
½ teaspoon	mixed spice
½ teaspoon	nutmeg
½ cup	plain flour
½ cup	pie apple
¾ cup	fresh breadcrumbs
1 tablespoon	golden syrup
1 tablespoon	parisienne essence

### Method:

Place all dried fruits and brandy into a 2-litre bowl. Mix and cook uncovered on **P3** for 10 minutes. Stir halfway through cooking. Cool. Beat butter and sugar in a large bowl with an electric mixer until light and fluffy. Add eggs, one at a time, beating between each addition. Stir in cooled fruits, then remaining ingredients. Grease 4 x 200 ml microwave safe cups. Place half a cup of mixture into each cup, pushing mixture in firmly. Smooth over the top of puddings with the back of a spoon. Place cups evenly around the edge of the microwave turntable and cook uncovered on **P3** for 20 minutes. Stand for 5 minutes before turning out. Repeat with remaining mixture. Serve with cream or custard.

### MINCE PIES • CAUTION

Take care not to overheat mince pies, otherwise burning can occur due to the high fat and sugar content of the filling. Check the temperature of the filling before consuming to avoid burning your mouth. **REMEMBER** even if the pastry is cold to the touch, the filling will be piping hot and will warm the pastry through.

## CHOCOLATE PÂTÉ

Makes 24 x 8 cm loaf tin

### Ingredients:

300 g	dark chocolate
400 g	can condensed milk
1 cup	brazil nuts
½ cup	hazelnuts
⅓ cup	glace cherries
½ cup	sultanas

### Method:

Break chocolate into pieces and place with condensed milk in a 2-litre dish. Cook on **P7** for 3 to 5 minutes, stirring twice during cooking. Fold through nuts and fruits. Line a 24 x 8 cm loaf tin with foil and pour in the mixture. Chill for several hours or until set. Turn out and serve thinly sliced.

## STIRRED CUSTARD

Makes: Approximately 400 ml

### Ingredients:

3 tablespoons	sugar
2 tablespoons	custard powder
1½ cups	milk
2	egg yolks, lightly beaten
1 teaspoon	vanilla essence

### Method:

Combine sugar and custard powder in 4-cup jug. Gradually stir in milk until smooth. Cook on **P6** for 4 to 5 minutes, stirring halfway through cooking. Add egg yolks and mix well. Cook on **P6** for further 30 to 60 seconds. Add vanilla, stir well and serve.

## BRANDY SAUCE

Makes: 1½ cups

### Ingredients:

2 tablespoons	butter
2 tablespoons	cornflour
3 tablespoons	sugar
2 tablespoons	golden syrup
1 cup	milk
¼ cup	brandy

### Method:

In a 1-litre pyrex jug melt butter on **P10** for 20 to 30 seconds. Blend in cornflour, sugar and golden syrup and cook on **P10** for 50 to 60 seconds. Add milk gradually and cook on **P6** for 3 to 4 minutes. Stirring halfway through cooking. Stir in brandy. Serve hot with fruit or Christmas pudding.

### CHOCOLATE BROWNIES

Makes: 1 x 20 cm square slice pan

#### Ingredients:

125 g	butter
200 g	chocolate
1 cup	caster sugar
1 teaspoon	vanilla essence
3	eggs
1 cup	plain flour

#### Method:

Grease and line 20 cm square pyrex dish. Melt butter and chocolate in 2-litre dish on **P7** for 2 minutes. Stir in sugar, vanilla essence, eggs and flour. Spread into prepared dish. Cook on **P7** for 5 to 6 minutes. Refrigerate until cold. Cut into squares.

### RHUBARB, APPLE & GINGER COMPOTE

Serves: 4

#### Ingredients:

300 g	rhubarb, trimmed cut to 3 cm lengths
2	apples, peeled, cored and diced
30 g	crystallised ginger, thinly sliced
½ cup	caster sugar
1	orange, grated rind and juice

#### Method:

Place all ingredients into a 2-litre microwave safe dish. Stir to dissolve sugar. Cook on **P10** for 8 to 10 minutes or until fruit is softened.

### MOCHA FUDGE

Makes: 64 x 2.5 cm square pieces

#### Ingredients:

395 g	can sweetened condensed milk
300 g	dark chocolate melts
1 teaspoon	vanilla extract
1 teaspoon	instant coffee powder
64	chocolate coated coffee beans

#### Method:

Grease a square (20 cm) cake pan, set aside. Place condensed milk and chocolate in a 1.5-litre microwave safe and heatproof bowl. Cook on **P7** for 2 minutes. Stir in vanilla and coffee. Mix until well combined. Cook on **P5** for 2 minutes. Stir and pour into prepared pan. Arrange coffee beans evenly over the fudge. Chill for 2 hours or until set. Cut into 2.5 cm squares to serve.

#### Tip:

Chocolate coated coffee beans are available from speciality coffee shops.

### PRESERVING PRECAUTIONS

Do not use your oven for home canning or the heating of any closed jar. Pressure will build up and the jar may explode. In addition, the microwave oven cannot maintain the food at the correct canning temperature. Improperly canned food may spoil and be dangerous to consume.

#### Jars and Bottles

Jars and bottles can be used to warm food to serving temperature. If the lid is removed first. Cooking should not be done in these containers since most are not heat resistant and during extended heating times, heat from food would cause cracking or breaking.

**Thermometers** are available for use in microwave ovens. DO NOT USE CONVENTIONAL MERCURY TYPE CANDY OR MEAT THERMOMETERS in food while cooking in the microwave oven.

Alternatively, a conventional meat thermometer may be used after the food is removed from the oven.

#### Sterilizing Jars

Jam jars can be sterilized by microwave ready for your jams. Half fill with water and heat them on **P10** power until water boils (approx.3 mins, for 2 jars). Empty and drain upside down on kitchen paper. The jars should be warm when filled with jam.

### TOMATO CHUTNEY

Makes: 3 cups (750 ml)

#### Ingredients:

250 g	onion, finely chopped
1.5 kg	ripe tomato, skins removed and chopped
1 teaspoon	salt
1 teaspoon	paprika
	pinch cayenne pepper
150 ml	malt vinegar
175 g	sugar

#### Method:

Place onions in a 3-litre dish. Cover. Cook on **P10** for 4 to 5 minutes. Add tomatoes. Cover. Cook on **P10** for 5 to 6 minutes. Add salt, spices and vinegar. Stir well. Cook on **P10** for 10 minutes, stirring halfway through. Add sugar, stir well and cook on **P7** for 35 to 40 minutes. Stirring occasionally. Pour into sterilised jars and seal.

### LEMON BUTTER

Makes: 1 cup (250 ml)

#### Ingredients:

½ cup	lemon juice
1 tablespoon	lemon rind
⅓ cup	sugar
3	egg yolks
1 tablespoon	butter
1 tablespoon	cornflour

#### Method:

Blend all ingredients in a 4-cup glass jug. Cook on **P6** for 4 to 5 minutes, stirring every minute. Pour into hot sterilised jars and seal immediately.

### BASIC WHITE SAUCE

Makes: 1 cup

**Ingredients:**

2 tablespoons butter  
 2 tablespoons flour  
                   salt and white pepper  
 1¼ cups milk

**Method:**

Place butter in a 4-cup jug. Cook on **P10** for 30 to 40 seconds. Stir in flour, salt and pepper. Gradually add milk, stirring until smooth. Cook on **P10** for 2 minutes, stirring every minute.

**Tip:** For cheese sauce, stir in ½ cup grated cheese once sauce has thickened.

### GRAVY

Makes: 2 cups

**Ingredients:**

2 tablespoons dripping or pan juice  
 1 small onion, finely chopped  
 2 tablespoons flour  
 1 tablespoon tomato paste  
 375 ml beef stock  
                   salt and pepper

**Method:**

Place dripping or pan juices and onion in a 2-cup jug. Cook on **P10** for 2 minutes. Add flour, tomato paste and half of the beef stock. Stir well. Cook on **P10** for 2 minutes. Add remaining stock. Stir well and cook on **P10** for a further 2 minutes. Season with salt and pepper. Serve with the meat of your choice.

### CHEESE SAUCE

Makes: 1½ cups

**Ingredients:**

40 g butter  
 2 tablespoons flour  
 1½ cups milk  
 ½ cup grated cheese

**Method:**

Melt butter in 1-litre jug on **P10** for 30 seconds. Add flour and mix well. Gradually stir in milk. Cook on **P10** for 3 to 4 minutes. Stirring halfway through cooking. Add cheese and cook on **P10** for a further 1 to 1½ minute. Stir and serve with vegetables of your choice.

**HINT:**

**COOKING SAUCES:**

When making some sauces in the microwave oven, less liquid may be needed as less evaporation occurs with a shorter cooking time.

### LEMON LIME CORDIAL

Makes: approximately 1.5 litres of undiluted cordial

**Ingredients:**

10 large lemons  
 6 limes  
 4 cups sugar  
 500 ml water  
 2 teaspoons citric acid

**Method:**

Squeeze juice from lemons and limes. Place in a 3 to 4-litre dish with the remaining ingredients. Cook on **P10** for 8 to 10 minutes. Stir 2 to 3 minutes during this cooking time to dissolve sugar. Cook on **P10** for 25 to 30 minutes, or until the mixture has become a syrupy consistency. Set aside to cool. Pour into bottles and seal. Store in the refrigerator and serve with cold water, soda or mineral water and fresh mint leaves if desired.

### RICH CHOCOLATE SAUCE

Makes: ¼ cups

**Ingredients:**

200 g chocolate pieces  
 300 ml cream

**Method:**

Combine chocolate and cream in a 1-litre jug. Cook on **P10** for 2 minutes. Mix well. Serve over ice cream.

### STRAWBERRY LIQUEUR

Makes: 750 ml

**Ingredients:**

500 g sugar  
 500 g washed and hulled strawberries  
 600 g brandy or whisky

**Method:**

Place sugar and strawberries in a 4-litre dish. Stir well. Cook on **P10** for 15 minutes. Stir in brandy or whisky. Pour into an airtight container. Store refrigerated for 2 to 3 months. Serve in liqueur glasses or as a tall drink with ice cubes and soda water.

### MINT SAUCE

Makes: Approximately ¼ cup

**Ingredients:**

60 ml water  
 1 tablespoon sugar  
 2 tablespoons brown vinegar  
 2 tablespoons mint, finely chopped

**Method:**

Combine all ingredients in 1-cup jug. Cook on **P10** for 30 to 60 seconds. Stir well and serve with Roast Lamb.



© Panasonic Appliances Microwave Oven (Shanghai) Co., Ltd. 2020

F0003CK20QP  
PA0720-0  
Printed in China