

# Panasonic®

## Operating Instructions Home Theater Audio System

---

Model No. **SC-HTB490**



Thank you for purchasing this product.  
For optimum performance and safety, please read these instructions carefully.  
Please keep this manual for future reference.

Your system and the illustrations can look differently.

### **Included Installation Instructions**

**The installation work should be done by a qualified installation specialist. (⇒ 9 to 13)**

Before commencing work, carefully read these installation instructions and the operating instructions to ensure that installation is performed correctly.

(Please keep these instructions. You may need them when maintaining or moving this system.)

# Safety precautions

## WARNING

### Unit

- To reduce the risk of fire, electric shock or product damage,
  - Do not expose this unit to rain, moisture, dripping or splashing.
  - Do not place objects filled with liquids, such as vases, on this unit.
  - Use the recommended accessories.
  - Do not remove covers.
  - Do not repair this unit by yourself. Refer servicing to qualified service personnel.
- To prevent injury, this unit must be securely attached to the wall in accordance with the installation instructions.

### AC mains lead

- To reduce the risk of fire, electric shock or product damage,
  - Ensure that the power supply voltage corresponds to the voltage printed on this unit.
  - Insert the mains plug fully into the socket outlet.
  - Do not pull, bend, or place heavy items on the lead.
  - Do not handle the plug with wet hands.
  - Hold onto the mains plug body when disconnecting the plug.
  - Do not use a damaged mains plug or socket outlet.

### Small objects

- Keep the screws and insulation sheet (battery) out of reach of children to prevent swallowing.

### Button-type battery (Lithium battery)

- Risk of fire, explosion and burns. Do not recharge, disassemble, heat above 60°C or incinerate.



**WARNING**  
DO NOT INGEST BATTERY,  
CHEMICAL BURN HAZARD

This remote control contains a coin/button cell battery. If the coin/button cell battery is swallowed, it can cause severe internal burns in just 2 hours and can lead to death. Keep new and used batteries away from children. If the battery compartment does not close securely, stop using the remote control and keep it away from children. If you think batteries might have been swallowed or placed inside any part of the body, seek immediate medical attention.

## CAUTION

### Unit

- To reduce the risk of fire, electric shock or product damage,
  - Do not install or place this unit in a bookcase, built-in cabinet or in another confined space. Ensure this unit is well ventilated.
  - Do not obstruct this unit's ventilation openings with newspapers, tablecloths, curtains, and similar items.
  - Do not place sources of naked flames, such as lighted candles, on this unit.
- This unit is intended for use in moderate climates.
- This unit may receive radio interference caused by mobile telephones during use. If such interference occurs, please increase separation between this unit and the mobile telephone.
- Set the unit up on an even surface away from direct sunlight, high temperatures, high humidity, and excessive vibration.
- This system might get warm after prolonged usage. This is normal. Do not be alarmed.



### AC mains lead

- The mains plug is the disconnecting device. Install this unit so that the mains plug can be unplugged from the socket outlet immediately.

### Button-type battery (Lithium battery)

- Danger of explosion if battery is incorrectly replaced. Replace only with the type recommended by the manufacturer.
- When disposing of the batteries, please contact your local authorities or dealer and ask for the correct method of disposal.
- Do not heat or expose to flame.
- Do not leave the battery(ies) in a car exposed to direct sunlight for a long period of time with doors and windows closed.
- Insert with poles aligned.
- Remove the battery if you do not use the remote control for a long period of time. Keep in a cool, dark area.

The symbols on this product (including the accessories) represent the following:

- ~ AC
-  Class II equipment (The construction of the product is double-insulated.)
- | ON
-  Standby

# Table of contents

Safety precautions . . . . .	2	Setup . . . . .	17
Supplied items . . . . .	3	Firmware updates . . . . .	18
Overview of controls . . . . .	4	HDMI CEC . . . . .	18
Making the connections . . . . .	7	Troubleshooting . . . . .	19
Placement . . . . .	9	Unit care . . . . .	21
Wireless Connections . . . . .	14	Specifications . . . . .	22
Connecting a USB device . . . . .	15	References . . . . .	23
Basic control . . . . .	15		
Sound . . . . .	16		



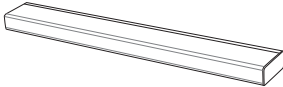
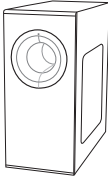

## Supplied items

### This system

<input type="checkbox"/> <b>1 Main unit (speaker)</b> (SU-HTB490)  	<input type="checkbox"/> <b>1 Active subwoofer</b> (SB-HWA490)  
--	--

### Accessories

Check and identify the supplied accessories.

<input type="checkbox"/> <b>1 Remote control (with a battery)</b> (N2QAYC000134)  	<input type="checkbox"/> <b>1 Wall mount bracket (left)</b>  	<input type="checkbox"/> <b>1 Wall mount bracket (right)</b>  
<input type="checkbox"/> <b>2 Screws (for wall mount bracket)</b>  	<input type="checkbox"/> <b>2 AC mains lead</b> <div style="display: flex; flex-direction: column; gap: 5px;"> <div><span style="background-color: black; color: white; padding: 2px;">1.5 m</span> For main unit</div> <div><span style="background-color: black; color: white; padding: 2px;">1.2 m</span> For active subwoofer</div> </div>	

# Overview of controls

Do the procedure with the remote control. You can also use the buttons on the main unit if they are the same.

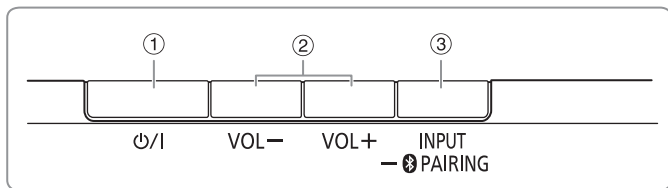

Main Unit (Front)

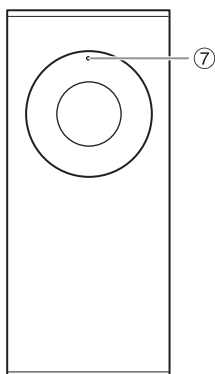
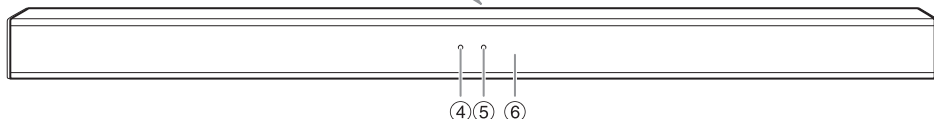

Active subwoofer (Front)

## Indicator legends

Indicator	Status	Indicator	Status
○ W	Lights up in white	⚡ W	Blinks in white
● B	Lights up in blue	⚡ B	Blinks in blue
● G	Lights up in green	⚡ G	Blinks in green
● Y	Lights up in yellow	⚡ Y	Blinks in yellow
● R	Lights up in red	⚡ R	Blinks in red
● X	Switches off		

### ① Standby/on switch [⏻/⏻]

Press to switch the unit from on to standby mode or vice versa. In standby mode, the unit is still consuming a small amount of power.

### ② Adjust the volume level (⇒ 16)

### ③ Select the input source



To start Bluetooth® pairing, press and hold [− PAIRING].

### ④ Indicator A

The indicator lights up or blinks in various colours depending on the operations performed. (⇒ above)

### ⑤ Indicator B

The indicator lights up or blinks in various colours depending on the operations performed. (⇒ above)

### ⑥ Remote control sensor

Point the remote control at the remote control sensor, away from obstacles and within the operation range.

Distance: Within approximately 7 m

Angle: Approximately 20° up and down, 30° left and right

### ⑦ WIRELESS LINK indicator (⇒ 14)

#### Note:

- Do not place objects in front of this system.
- Do not place objects on top of the main unit. Do not block the top surface of the main unit for proper ventilation.
- Remove dust and dirt from this system regularly. (⇒ 21)

## Main unit (Bottom)

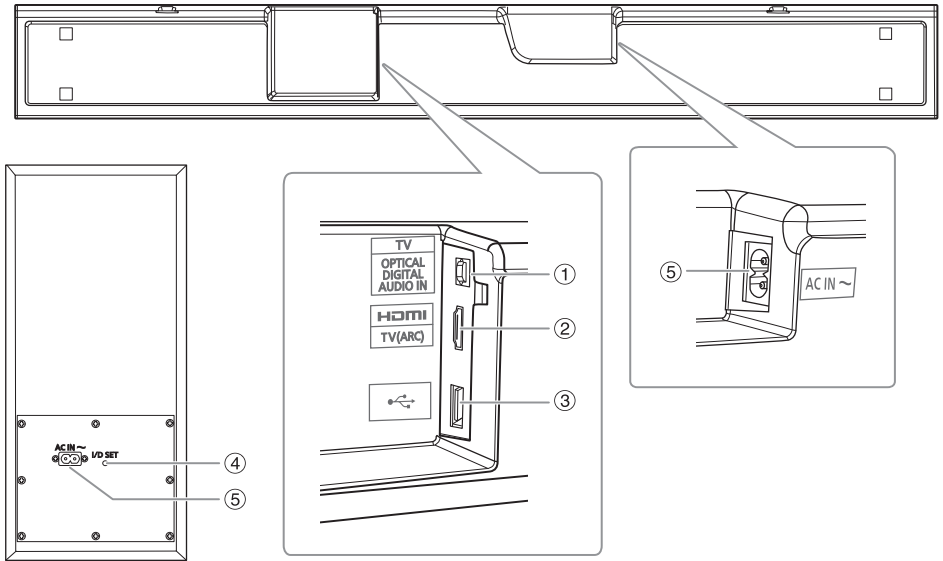

## Active subwoofer (Rear)

- ① TV OPTICAL DIGITAL AUDIO IN terminal (⇒ 7)
- ② HDMI TV (ARC) terminal (⇒ 7)
- ③ USB port (⇒ 15, 18)
- ④ I/D SET button

The main unit is by default already paired with the active subwoofer. Hence this button is used only when the main unit and the active subwoofer need to be paired again. (⇒ 20)

- ⑤ AC IN terminal (⇒ 8)

## Remote control

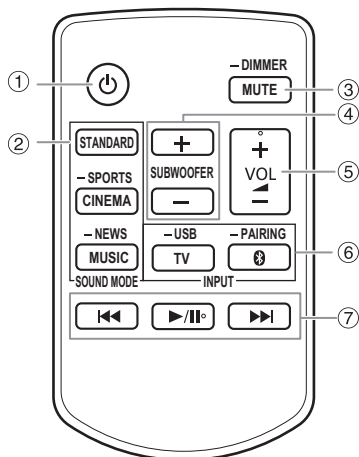

- 1 Switch the main unit on or off
- 2 Select the sound mode (⇒ 16)
- 3 Mute the sound (⇒ 16)  
Dim the indicators (⇒ 27)
- 4 Select the subwoofer setting (⇒ 16)
- 5 Adjust the volume level (⇒ 16)
- 6 Input selectors (⇒ 25)  
To start Bluetooth® pairing, press and hold [ -PAIRING ].
- 7 USB and Bluetooth® playback control (⇒ 15)

## Preparing the remote control

### Before using for the first time

Remove the insulation sheet.

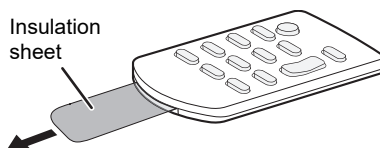

### Replacing the battery

Replace with a new battery (CR2025 lithium battery).

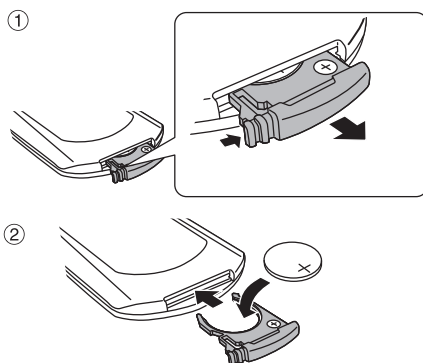

Insert a new battery with the (+) side facing up.

### Caution

#### Avoid the use in the following conditions

- High or low extreme temperatures during use, storage or transportation.
- Replacement of a battery with an incorrect type.
- Disposal of a battery into fire or a hot oven, or mechanically crushing or cutting of a battery, that can result in an explosion.
- Extremely high temperature and/or extremely low air pressure that can result in an explosion or the leakage of flammable liquid or gas.

# Making the connections

Switch off all equipment before connection.

Components and cables are sold separately.

**Connect the AC mains lead only after all the other connections have been made.**

When connecting to 4K compatible equipment and 4K Ultra HD TV, use High Speed HDMI cables which support 18 Gbps bandwidth.

## Connecting the TV

### ■ Connect an ARC compatible TV

Connect to the ARC compatible terminal of the TV with an ARC compatible high speed HDMI cable.

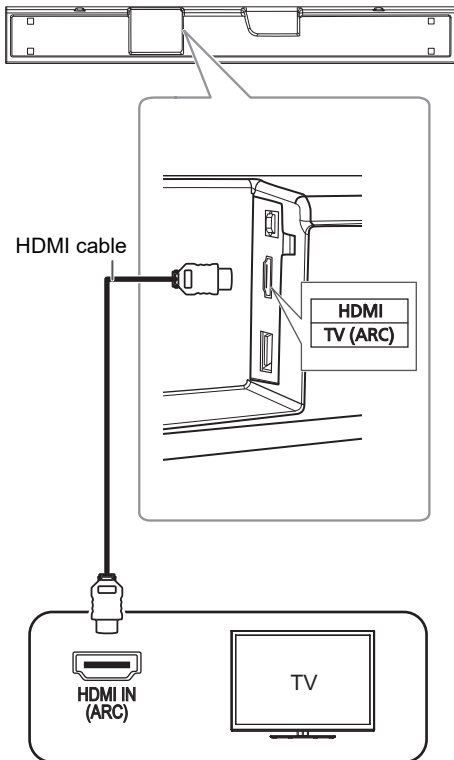

### ARC (Audio Return Channel)

ARC is an HDMI function that lets you enjoy both sound and TV pictures with one HDMI cable, the optical digital audio cable that is usually required in order to listen to sound from a TV is no longer required.

### ■ Connect a non-ARC compatible TV

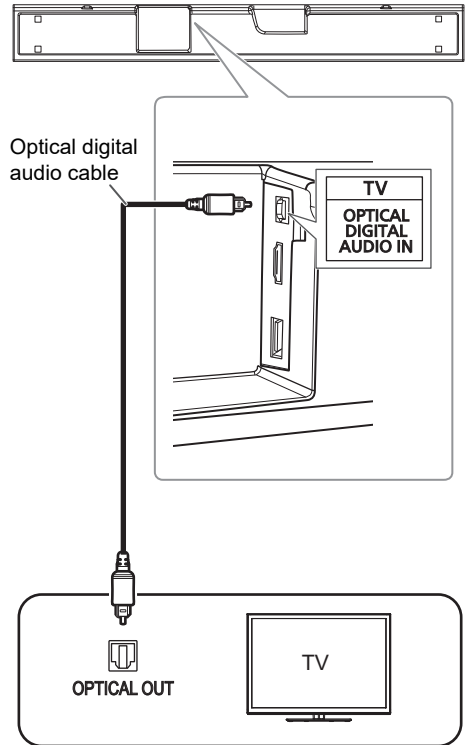

When connecting the optical digital audio cable, observe the orientation and insert the tip correctly into the terminal.

## Connecting the AC mains lead

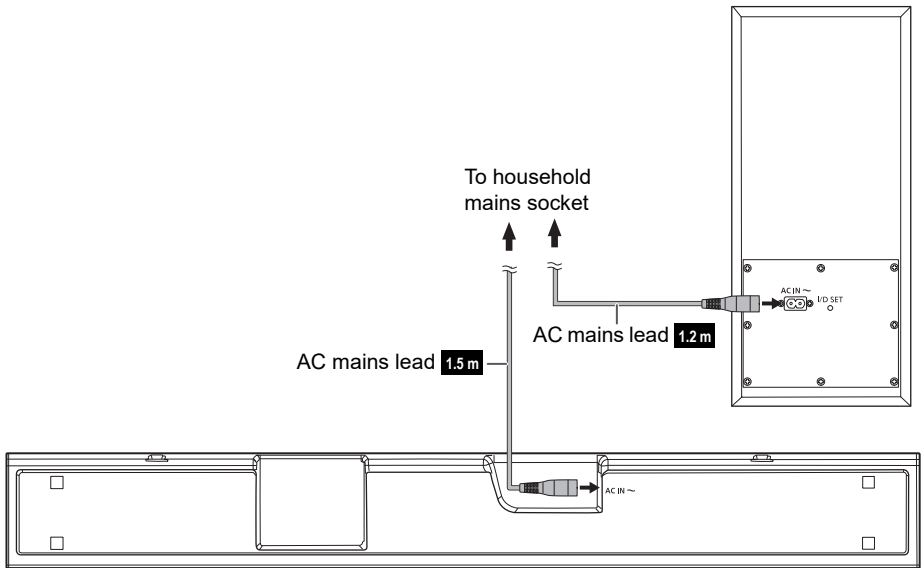

### Conserving power

The system consumes a small amount of power when it is in standby mode. Disconnect the power supply if you do not use the system.

The main unit will automatically switch to standby mode when no signal is input and no operation is performed for approx. 20 minutes. Refer to page 17 "Auto off" to switch this function off.

#### Note:

The active subwoofer is in the standby condition when the AC mains lead is connected. The primary circuit is always "live" as long as the AC mains lead is connected to an electrical outlet.



---

# Placement

---

## Safety Precautions

**Professional installation is required.**

**The installation should never be done by any other than a qualified installation specialist. PANASONIC DISCLAIMS ANY PROPERTY DAMAGE AND/OR SERIOUS INJURY, INCLUDING DEATH RESULTING FROM IMPROPER INSTALLATION OR INCORRECT HANDLING.**

- Be sure to install the main unit as indicated within this operating instructions.
- Attach using techniques suited to the structure and materials of the installation location.

### Caution

- This system is to be used only as indicated in these instructions. Failure to do so may lead to damage to the amplifier and/or the speaker, and may result in the risk of fire. Consult a qualified service person if damage has occurred or if you experience a sudden change in performance.
- Do not attempt to attach the main unit to a wall using methods other than those described in this manual.

### Note:

- Do not hold the main unit in one hand to avoid injury, you may drop the main unit when carrying it.
- To prevent damage or scratches, lay down a soft cloth and perform the assembly on it.
- Do not put the system in a metal cabinet.
- Keep magnetised items away. Magnetised cards, watches, etc., can be damaged if put too near to the system.
- Place the active subwoofer within a few meters from the main unit and in a horizontal position with the top panel facing upward.
- Depending on the position of the active subwoofer, the effect may vary.

Placing the active subwoofer too close to the walls and corners can result in excessive bass. Cover walls and windows with thick curtains.

You may change the position of the active subwoofer, or adjust the subwoofer level (⇒ 16) to achieve optimum effect.

### When carrying the active subwoofer

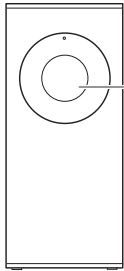

**Do not hold the active subwoofer from this opening.**  
The parts inside may get damaged.

Always hold the bottom of the active subwoofer when moving it.

---

## Wireless interference

Interference may occur if you are using other devices (wireless LAN/microwave ovens/cordless phones, etc.) that use the 2.4 GHz frequency band, causing some communication problems (sound is interrupted, sound skips, there is a lot of noise, etc.).

If this happens, separate the other electronic equipment from the main unit and active subwoofer so that interference does not occur.

## Placing the main unit in a rack or on a table

### Additionally required accessories (commercially available)

- Fall prevention cord (x2)
- Screw eyes (to attach the fall prevention cord) (x2)

#### Note:

- Use commercially available screws that are capable of supporting over 30 kg.
- Use a cord that is capable of supporting over 30 kg (with a diameter of about 1.5 mm).

## 1 Attach the cord to the main unit.

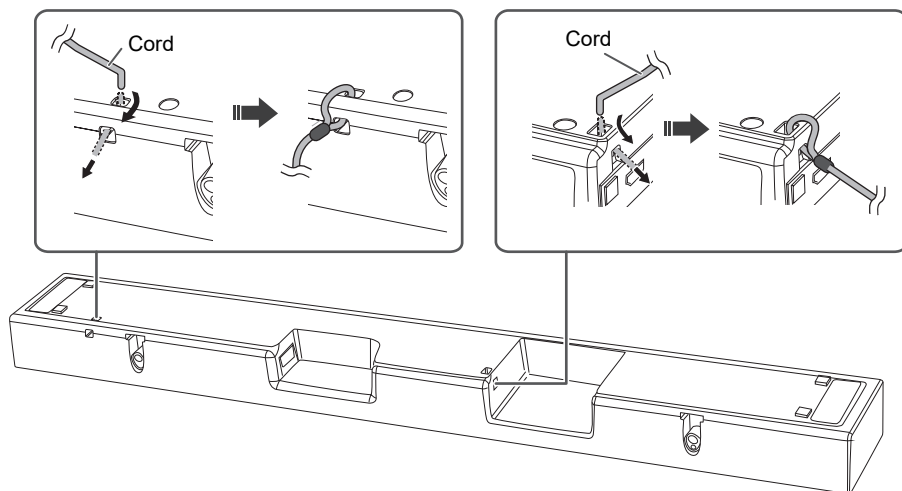

If the cord cannot be threaded through the holes, try bending the cord, about 5 mm apart from the tip, at an angle of 45° (as illustrated above).

## 2 Place the main unit in the desired position and attach each cord onto the rack or table.

Make sure that the slack of the cord is minimal.  
Do not lean the main unit against the TV or wall.

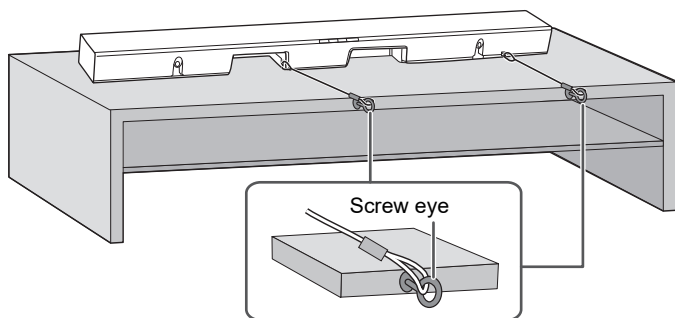

Attach the screw eye at a position capable of supporting over 30 kg.  
Depending on the placement of the main unit, the screwing position of the screw eye may differ.

## Attaching the main unit to a wall

### WARNING

To prevent injury, this unit must be securely attached to the wall in accordance with the installation instructions.

The main unit can be wall mounted using the supplied wall mount brackets, etc. Make sure that the screw used and the wall are strong enough to support the weight of at least 30 kg.

The screws and other items are not supplied as the type and size will vary with each installation.

- Refer to step 3 for details about the required screws.
- Be sure to attach the fall prevention cord as a secondary safety measure.

### Additionally required accessories (commercially available)

- Screws for wall mounting (x2)
- Fall prevention cord (x2)
- Screw eyes (to attach the fall prevention cord) (x2)

#### Note:

Use a cord that is capable of supporting over 30 kg (with a diameter of about 1.5 mm).

## 1 Attach the cord to the main unit.

Perform step 1 in "Placing the main unit in a rack or on a table". (⇒ 10)

## 2 Attach the wall mount brackets to the main unit.

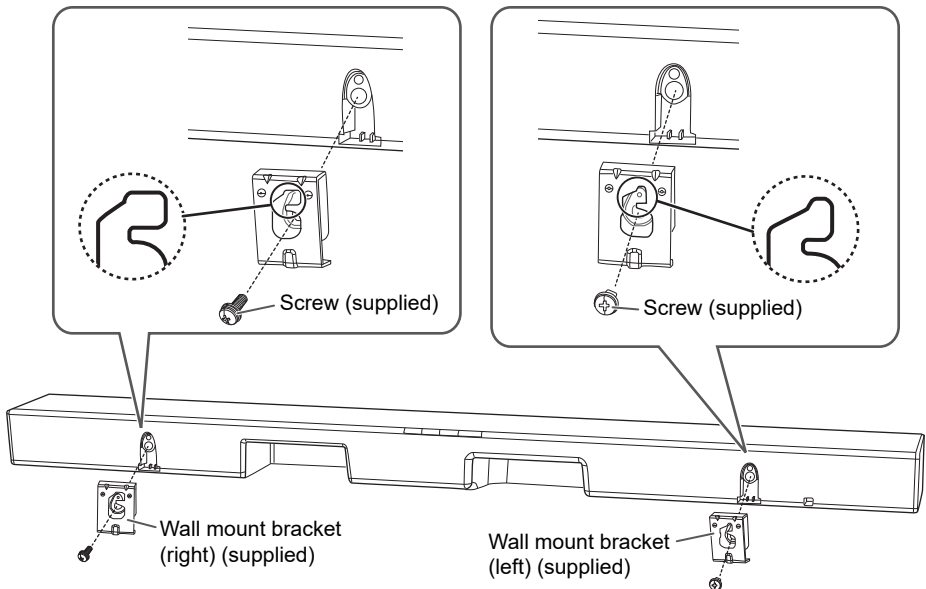

#### Note:

Handle the main unit with care after you have attached the wall mount brackets. To prevent damage or scratches, remove the wall mount brackets if you want to put the main unit in a rack or on a table.

### 3 Drive the screws into the wall.

- Use the measurements indicated below to identify the screwing positions on the wall.
- Leave at least 100 mm of space above of the main unit to allow enough space for fitting the main unit.
- Be sure to use a level to ensure that both mounting holes are level to each other.

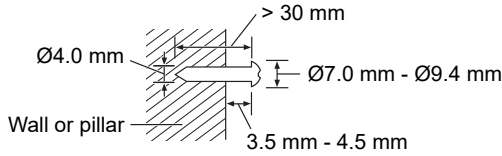

#### Front view (semi-transparent image)

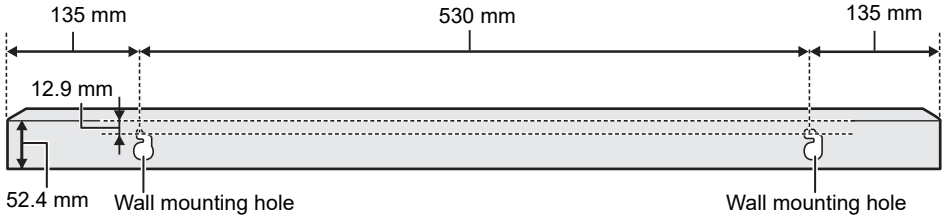

### 4 Fit the main unit securely onto the screws.

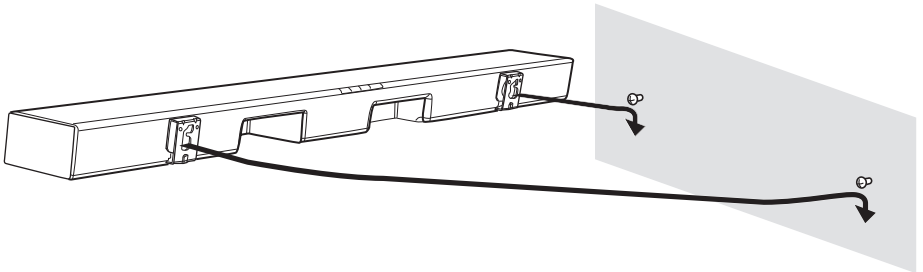

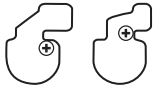
DO	DO NOT
 <p>Move the speaker so that the screw is in this position.</p>	 <p>In this position, the speaker will likely fall if moved to the left or right.</p>

## 5 Secure the cord to the wall.

Make sure that the slack of the cord is minimal.

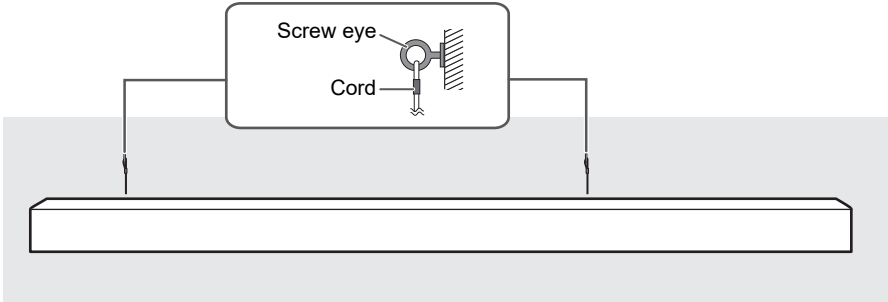

# Wireless Connections

## Active subwoofer wireless connection

### Preparation

Switch on the main unit.

Check that the wireless link is activated.

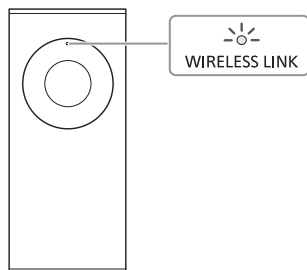

### WIRELESS LINK indicator

On: The wireless link is activated.

Off: The wireless link is not activated.

Blinks: The active subwoofer is trying to activate the wireless link with the main unit.

#### Note:

- The wireless link will be activated when the main unit and the active subwoofer are both switched on.
- The I/D SET button is only used when the main unit is not paired with the active subwoofer. (⇒ 20)

## Bluetooth® connection

You can connect and play an audio device wirelessly through Bluetooth®.

### Preparation

- Switch on the main unit.
- Switch on the Bluetooth® feature of the device and put the device near the system.
- Read the operating instructions of the device for details.

### Pairing a device

#### Preparation

If this system is connected to a Bluetooth® device, disconnect it (⇒ below).

#### 1 Press [ –PAIRING].

If the Indicator A blinks fast in blue, continue with step 3.

#### 2 Press and hold [ –PAIRING] until Indicator A blinks fast in blue.

#### 3 Select “SC-HTB490” from the Bluetooth® menu of the device.

The MAC address (e.g., 6C:5A:B5:B3:1D:0F) may be shown before “SC-HTB490” is shown. If prompted for a passkey, input “0000” or “1234”.

The Indicator A stops blinking and lights up.

#### Note:

You can pair up to 8 devices with this system. If a 9th device is paired, the device that has not been used for the longest time will be replaced.

### Connecting a paired device

#### Preparation

If this system is connected to a Bluetooth® device, disconnect it (⇒ below).

#### 1 Press [ –PAIRING].

#### 2 Select “SC-HTB490” from the Bluetooth® menu of the device.

#### Note:

When sound interruption occurs during use with a wireless TV:  
– Change the TV to use the 5 GHz wireless range, or  
– Adjust the main unit to a position with the least interference, such as put it in front of the TV instead of below the TV.

### Disconnecting a device

Press and hold [  –PAIRING].

#### Note:

- This system can only connect to one device at a time.
- When “Bluetooth®” is selected as the source, this system will automatically try to connect to the last connected device.
- The Bluetooth® device will be disconnected when you select another source.

## Connecting a USB device

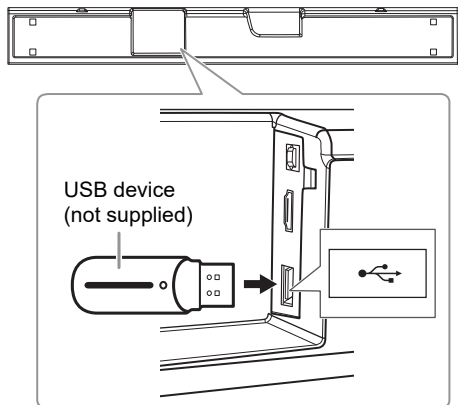

### Decrease the volume and connect the USB device to the USB port.

Hold the main unit when connecting or disconnecting the USB device.

#### Note:

Do not use a USB extension cable. The system cannot recognise USB device connected through a cable.

## Basic control

### Preparation

Switch on the TV and/or connected device.

**1 Press [⏻] to switch on the system.**

**2 Select the input source.**

TV: Press [TV].

Bluetooth®: Press [Ⓜ -PAIRING].

USB: Press and hold [-USB].

Alternatively, press [INPUT] on the main unit to select the source.

→ TV → Bluetooth® → USB →

Indicator A	Status
TV	○ W
Bluetooth®	● B
USB	● G

### When “Bluetooth®” is selected as the source

Select this system as the output speaker from the menu of the connected device.

Play	Press [▶/⏪].
Pause	Press [▶/⏪]. Press again to continue playback.
Skip	Press [◀◀] or [▶▶] to skip track.

### When “USB” is selected as the source

You can enjoy the MP3 store in the USB device using the following controls.

Play	Press [▶/⏪].
Pause	Press [▶/⏪]. Press again to continue playback.
Skip	Press [◀◀] or [▶▶] to skip track.

#### Note:

- This system does not guarantee connection with all USB devices.
- This system supports USB 2.0 full speed.
- This system can support USB devices of up to 32 GB.
- Only FAT16/32 file system is supported.
- Files are defined as tracks and folders are defined as albums.
- Tracks must have the extension “.mp3” or “.MP3”.
- Tracks will not necessarily be played in the order you recorded them.
- Some files can fail to work because of the sector size.
- Number of MP3 files on a USB device that this system can access:
  - 500 albums (including root folder)
  - 999 tracks

## To adjust the volume of this system

Press [+ VOL -].

Volume range: 0 to 100

The indicator B blinks in yellow when you increase the level. When you decrease the level, the indicator A blinks in yellow.

## To mute the sound

Press [MUTE].



Indicator B blinks in yellow.

To cancel, press [MUTE] again or adjust the volume.

# Sound

## Sound Mode

Select the sound mode to suit the TV programme or connected equipment.

Press ([STANDARD], [CINEMA] or [MUSIC]) or press and hold ([-SPORTS] or [-NEWS]) to select the desired sound mode.

The indicator B lights up according to the sound mode selected.

Sound mode	
<b>STANDARD</b> <input type="radio"/> X	Best suited for dramas and comedy shows.
<b>MUSIC</b> <input checked="" type="radio"/> G	Enhance the sound of musical instruments and songs.
<b>CINEMA</b> (default) <input type="radio"/> W	Produces three-dimensional sound unique to movies.
<b>NEWS</b> <input checked="" type="radio"/> B	Enhance the voice of news and sports commentaries.
<b>SPORTS</b> <input checked="" type="radio"/> Y	Produces a realistic sound for live sports broadcasts.

## Subwoofer Level

Adjust the subwoofer level.

Press [+ SUBWOOFER -].

SW 1, SW 2, SW 3 (default), SW 4, SW 5

The indicator B blinks in yellow when you increase the level. When you decrease the level, the indicator A blinks in yellow.

## Dual Audio

Sets the preferred audio channel mode when there are two audio modes received by this system.

Press and hold [▶/III] to change the setting.

Dual Audio	
<b>Main</b> (default)	<input checked="" type="radio"/> Y <input type="radio"/> W
<b>Secondary</b>	<input checked="" type="radio"/> Y <input checked="" type="radio"/> G
<b>Main + Secondary</b>	<input checked="" type="radio"/> Y <input checked="" type="radio"/> B

Note:

- This effect only works if the audio output of the TV or player is set to "Bitstream" and "Dual Mono" is available in the sound source.
- The indicators for the selected setting maintain for 5 seconds and then exits the setting mode.



## Audio format

You can view the current audio format.

**Press and hold [STANDARD].**

Audio format	
Dolby Digital	Y  W
DTS®	Y  G
PCM	Y  B

### Note:

- The indicators light up for about 5 seconds for the corresponding supported audio format.
- No audio format is shown if "Bluetooth®" or "USB" is the source.
- If the current audio format is unsupported, the indicators light up as below.



Change to another supported audio source.

## Setup

### Dimmer

You can dim the indicators on the main unit.

**Press and hold [-DIMMER] to change the brightness of the indicators.**

### Auto off

The main unit is automatically switched off if there is no audio input and when you do not use it for approximately 20 minutes.

**Press and hold [+ SUBWOOFER].**

Auto Off	
On (default)	Y  B
Off	Y  W Indicator B blink 2 times then lights up.

### Note:

The indicators for the selected setting maintain for 5 seconds and then exits the setting mode.

### Volume limitation

The volume is set to 50 when you switch on the system although the volume is set to above 50 before it is switched off.

**Press [MUTE], [STANDARD], [MUTE] and [STANDARD] consecutively.**

Press within 3 seconds between each button.

Volume Limitation	
On	Y  B
Off (default)	Y  W Indicator B blink 2 times then lights up.

### Bluetooth® Standby

This function automatically switches on the system when you establish a Bluetooth® connection from a paired device.

**Press and hold [SUBWOOFER -].**

On	Y  B
Off (default)	Y  W Indicator B blink 2 times then lights up.

### Note:

If this function is set to "On", the standby power consumption will increase.

### Software version

You can check the version of the software.

**Press and hold [VOL+] and [INPUT] on the main unit.**

Software version	
Software version	W  W
Wireless version	Y  Y

Count the numbers of blinks for the version number, e.g. Indicator A blink 2 times followed by Indicator B blink 5 times indicate software version 25.

---

## Firmware updates

Occasionally, Panasonic may release updated firmware for this system that may add or improve the way a feature operates. These updates are available free of charge.



**DO NOT DISCONNECT the AC mains lead while updating the firmware.**

During the update process, no other operations can be performed.

### Preparation

Download the latest firmware from the following website and store it to a USB device to update the firmware.

<https://panasonic.jp/support/global/cs/audio/>

(This site is in English only.)

- 1 Press [⏻] to switch on the system**
- 2 Press and hold [–USB] to select USB as the input source.**
- 3 Connect the USB device containing the latest firmware to the main unit.**

The system switches off automatically when the update completes and then switch on again.

#### Note:

- You cannot output sound from this unit while updating the firmware.
- To view the TV during update, change the settings on the TV to have the sound output from the TV's speakers. Refer to the operating instructions of the TV for details.

---

## HDMI CEC

**This unit supports “HDMI CEC” (Consumer Electronics Control) function.**

See the operating instructions for connected equipment for operational details.

### Preparation

Confirm that the HDMI connection has been made. (⇒ 7)

---

### Power on link

When the TV is switched on, the main unit also switches on automatically.

---

### Power off link

When the TV is switched off, the main unit also switches off automatically. (This function does not work when Bluetooth® or USB is the source.)

---

### Volume adjustment

You can control the volume setting of this system using the volume or mute button on the TV remote control.

If the TV's speaker selection is changed to the TV speakers, the main unit's speakers are muted. Muting will be cancelled by selecting the main unit's speakers again.

---

### Changing speakers

When the main unit switches on, this system will be selected as the TV's speakers automatically. When you switch off the main unit, TV speakers will be automatically activated.

#### Note:

The operation cannot be guaranteed on all HDMI CEC equipment.

# Troubleshooting

Before requesting service, make the following checks. If you are in doubt about some of the check points, or if the solutions indicated do not solve the problem, consult your dealer for instructions.

## Common problems

### No power

- After connecting the AC mains lead, wait about 10 seconds before switching on the main unit.
- Disconnect the AC mains lead for 10 seconds before connect again.
- After switching on the main unit, if the main unit immediately switches off, disconnect the AC mains lead and consult your dealer.
- If the main unit does not switch on when switching on TV (HDMI CEC), switch on the main unit manually.

### No operations can be done with the remote control.

- Remove the insulation sheet before you use the remote control for the first time. (⇒ 6)
- Examine that the battery is installed correctly. (⇒ 6)
- The battery is weak. Replace it with a new one. (⇒ 6)
- Set the remote control code again after replacing the battery. (⇒ 21)
- Use the remote control within the correct operation range. (⇒ 4)

### The system automatically switched to standby mode

- “Auto off” function is on.  
The system automatically switches to standby mode if there is no signal input and no operation is being performed for approximately 20 minutes. Refer to page 17 for switch off this function.

## Bluetooth®

### Pairing cannot be done.

- Check the Bluetooth® device condition.
- The device is out of the 10 m communication range. Move the device nearer to the system.

### The device cannot be connected.

- The pairing of the device was unsuccessful. Do pairing again.
- The pairing of the device has been replaced. Do pairing again.
- This system might be connected to a different device. Disconnect the other device and try connecting the device again.
- The system may have a problem. Switch off the system and then switch on again.

### The device is connected but audio cannot be heard through the system.

- For some built-in Bluetooth® devices, you have to set the audio output to “SC-HTB490” manually. Read the operating instructions of the device for details.

### Sound from the device is interrupted.

- The device is out of the 10 m communication range. Move the device nearer to the system.
- Remove any obstacle between the system and the device.
- Other devices that use the 2.4 GHz frequency band (wireless router, microwaves, cordless phones, etc.) are interfering. Move the device nearer to the system and distance it from the other devices.

## HDMI

### HDMI CEC related operations no longer function properly.

- Check the setting on the connected devices.
  - Switch on HDMI CEC function on the connected devices.
  - Select this system as the speaker in the TV’s HDMI CEC menu.
- When the HDMI connections are changed, after a power failure or after the AC mains lead has been removed, HDMI CEC operations may not function properly.
  - Switch on all the devices that are connected to the TV with an HDMI cable and then switch on the TV.
  - Switch off the HDMI CEC settings of the TV and switch it on again. For details refer to the operating instructions for the TV.
  - While the system and the TV are connected with an HDMI cable, switch on the TV, disconnect the AC mains lead of this system and then connect it again.

## Sound

### No sound

- Cancel muting. (⇒ 16)
- Check the connections to the other devices. (⇒ 7)
- Make sure that the received audio signal is compatible with this system.
- If the system is connected to the TV with an HDMI cable only, make sure that the HDMI terminal of the TV is labelled “HDMI (ARC)”. If not, connect an optical digital audio cable. (⇒ 7)
- Check the connections. Change the cables if the connections are correct.
- Check the audio output settings on the connected device.
- The situation may improve by changing the digital audio output setting on the connected device from “Bitstream” to “PCM”.

### The dual audio cannot be changed from main to secondary.

- If the audio received from the connected device is not "Dual Mono" or the output setting is not "Bitstream", the setting cannot be changed from this system. Change the setting on the connected device.

### The sound lags behind the image.

- Depending on the TV, when this system is connected to it via Bluetooth®, the sound output from this system may lag behind the TV image. Connect this system and the TV with an HDMI cable/optical digital audio cable. (⇒ 7)

### The audio format shown on the display does not correspond to the playback source.

- If the playback source is Dolby Digital or DTS®, set the audio output setting of the connected equipment (e.g., TV, player) to bitstream. For details, refer to the operating instructions for the connected equipment.

### There is no audio.

#### The power of the main unit switches off automatically.

(When the main unit detects a problem, a safety measure is activated and the main unit automatically switches to standby mode.)

- There is a problem with the amplifier.
- Is the volume extremely high?  
If so, lower the volume.
- Is this system placed in an extremely hot place?  
If so, move this system to a cooler place and wait a few moments and then try to switch it on again.

If the problem persists, confirm the indicators status, switch off this system, disconnect the AC mains lead and consult your dealer. Please be sure to remember the indicators status and inform the dealer.

### Active subwoofer

#### No power.

- Make sure the AC mains lead of the active subwoofer is connected.

#### After switching on the subwoofer, it immediately switches off.

- Disconnect the AC mains lead and consult your dealer.

#### No sound from the subwoofer.

- Check that the active subwoofer is switched on.
- Check that the WIRELESS LINK indicator switched on. (⇒ 14)

### The WIRELESS LINK indicator does not switched on.

- There is no link between the main unit and the active subwoofer.  
Check that the main unit is switched on.
- The active subwoofer and the main unit may not be paired correctly. Try the following operation.  
(Wireless pairing)

- ① Switch on the main unit.
- ② Press and hold [I/D SET] on the rear of active subwoofer for a minimum of 3 seconds.  
The wireless link indicator will blink.
- ③ Press [MUTE], [CINEMA], [MUTE] and [  ] consecutively within 3 seconds.

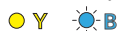

When the wireless link pairing is successful, the indicator B stop blinking and lights up blue.  
Consult your dealer if the problem persists.

### Error indications



- There is a problem with the amplifier of the system.
- Disconnect the AC mains lead and consult the dealer.



- Check HDMI connection.
- Switch off the main unit and then switch it on again.
- Disconnect the HDMI cable.



- Switch off the main unit and then switch it on again.
- Consult your dealer if the problem persists.

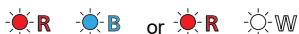

- The remote control and the main unit are using different codes. Change the code of the remote control. (⇒ 21)



- The USB device is drawing too much power.  
Disconnect the USB device, switch off the system and then switch on again.
- Check the connection, it may be caused by a faulty USB cable.

---

## Remote control code

When other Panasonic equipment responds to the remote control of this system, change the remote control code for this system.

### Preparation

- Switch off all other Panasonic products.
- Switch on this system.
- Aim the remote control at the remote control sensor of this system.

### To set the code to code 2

Press and hold [▶▶] and [+ SUBWOOFER] on the remote control for a minimum of 4 seconds.



### To set the code to code 1

Press and hold [▶▶] and [SUBWOOFER -] on the remote control for a minimum of 4 seconds.



---

## System reset

Reset the system when the following situations occur:

- There is no response when buttons are pressed.
- You want to clear and reset the memory contents.

Press and hold [⏻/⏪] on the main unit for a minimum of 10 seconds.

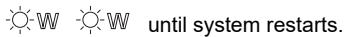

until system restarts.

### Note:

The remote control code will set back to code 1 after system reset, refer to "Remote control code" on how to change to code 2.

---

## Unit care

**Disconnect the AC mains lead before maintenance. Clean this system with a soft, dry cloth.**

- When dirt is heavy, wring a cloth moistened in water tightly to wipe the dirt, and then wipe it with a dry cloth.
- When cleaning the speakers, use a fine cloth. Do not use tissues or other materials (towels, etc.) that can fall apart. Small grains may get stuck inside the speaker cover.
- Never use alcohol, paint thinner or benzine to clean this system.
- Before using chemically treated cloth, read the instructions that came with the cloth carefully.

### To dispose or transfer this system

This system may keep the user settings information in the main unit. If you discard the main unit either by disposal or transfer, then follow the procedure to return all the settings to the factory presets to delete the user settings. (⇒ left)

- The operation history may be recorded in the memory of the main unit.

# Specifications

## General

<b>Power supply</b>	AC 220 V to 240 V, 50 Hz
<b>Power consumption</b>	
Main unit	24 W
Active subwoofer	22 W
<b>Power consumption in standby mode (approximate)</b>	
Main unit	
When “Bluetooth® Standby” is off	0.5 W
When “Bluetooth® Standby” is on	2.0 W
Active subwoofer	0.5 W

## Dimensions (W x H x D)

Main unit	
For table top layout	800 mm x 56 mm x 101 mm
For wall mounting layout	800 mm x 64 mm x 108 mm
Active subwoofer	171 mm x 382 mm x 363 mm

## Mass

Main unit	
For table top layout	1.9 kg
For wall mounting layout	2.0 kg
Active subwoofer	5.7 kg

**Operating temperature range** 0°C to +40°C

**Operating humidity range** 20% to 80% RH (no condensation)

## Amplifier section

### RMS output power: Dolby Digital Mode

Front ch	60 W per channel (4 Ω, 1 kHz, 10% THD)
Subwoofer ch	120 W per channel (3 Ω, 100 Hz, 10% THD)
Total RMS Dolby Digital mode power	240 W (Non-simultaneous Drive)

## Terminals section

### HDMI output (ARC)

Terminal Type A (19 pin) connector x 1

### Digital audio input

Optical digital input Optical terminal x 1  
Sampling frequency 32/44.1/48 kHz

### USB Port

USB standard USB 2.0 full speed  
Media file format support MP3 (\*.mp3)  
Sampling frequency 32/44.1/48 kHz  
Audio word size 16 bits  
Channel count 2 channels  
USB device file system FAT16, FAT32  
For Software update

## Audio format section

### TV ARC input

LPCM (Max 2 ch)  
Dolby Digital  
DTS® Digital Surround

### Optical digital input

LPCM (Max 2 ch)  
Dolby Digital  
DTS® Digital Surround

## Speaker section

### Front speakers (Built-in)

Full range 4.5 x 12 cm cone type x 2

### Active subwoofer

Woofer 16 cm cone type x 1

## Bluetooth® section

### Version

Bluetooth® Ver. 4.2

### Class

Class 1

### Supported profiles

AVRCP, A2DP

### Frequency band

2.4 GHz band FH-SS

### Operation distance

10 m line of sight

### Supported codec

SBC

## Wireless section

### Wireless module

Frequency range 2404 MHz to 2476 MHz  
RF output power 10 dBm (max)

### Note:

- Specifications are subject to change without notice.
- Mass and dimensions are approximate.
- Total harmonic distortion is measured by the digital spectrum analyser.

# References

## About Bluetooth®

Panasonic bears no responsibility for data and/or information that is compromised during a wireless transmission.

### Frequency band

- This system uses the 2.4 GHz frequency band.

### Certification

- This system conforms to the frequency restrictions and has received certification based on frequency laws. Thus, a wireless permit is not necessary.
- The actions below are punishable by law in some countries:
  - Taking apart or modifying the unit.
  - Removing specification indications.

### Restrictions of use

- Wireless transmission and/or usage with all Bluetooth® equipped devices is not guaranteed.
- All devices must conform to standards set by the Bluetooth SIG, Inc.
- Depending on the specifications and settings of a device, it can fail to connect or some operations can be different.
- This system supports Bluetooth® security features. But depending on the operating environment and/or settings, this security is possibly not sufficient. Transmit data wirelessly to this system with caution.
- This system cannot transmit data to a Bluetooth® device.

### Range of use

- Use this device at a maximum range of 10 m.
- The range can decrease depending on the environment, obstacles or interference.

### Interference from other devices

- This system may not function properly and troubles such as noise and sound jumps may arise due to radio wave interference if this unit is located too close to other Bluetooth® devices or the devices that use the 2.4 GHz band.
- This system may not function properly if radio waves from a nearby broadcasting station, etc. is too strong.

### Intended usage

- This system is for normal, general use only.
- Do not use this system near an equipment or in an environment that is sensitive to radio frequency interference (example: airports, hospitals, laboratories, etc.).

# Licenses

The terms HDMI and HDMI High-Definition Multimedia Interface, and the HDMI Logo are trademarks or registered trademarks of HDMI Licensing Administrator, Inc. in the United States and other countries.

The Bluetooth® word mark and logos are registered trademarks owned by Bluetooth SIG, Inc. and any use of such marks by Panasonic Corporation is under license. Other trademarks and trade names are those of their respective owners.

Manufactured under license from Dolby Laboratories.

Dolby, Dolby Audio, and the double-D symbol are trademarks of Dolby Laboratories Licensing Corporation.

For DTS patents, see <http://patents.dts.com>.  
Manufactured under license from DTS, Inc. DTS, Digital Surround, and the DTS logo are registered trademarks or trademarks of DTS, Inc. in the United States and other countries.  
© 2020 DTS, Inc. ALL RIGHTS RESERVED.



### Disposal of Old Equipment and Batteries Only for European Union and countries with recycling systems

These symbols are only valid in the European Union and countries with recycling systems.



If you wish to discard this product, please contact your local authorities or dealer and ask for the correct method of disposal.

# Panasonic Warranty

1. Subject to the conditions of this warranty Panasonic or its Authorised Service Centre will perform necessary service on the product, without charge for parts or labour, if in the opinion of Panasonic the product is found to have a manufacturing defect within one (1) year or (12 months) (the "warranty period") from the date of purchase appearing on your purchase receipt.
2. This warranty only applies to Panasonic products purchased in Australia and sold by Panasonic Australia, it's Authorised Distributors, or Dealers, and only where the products are used and serviced within Australia or its territories. Warranty cover only applies to the services that are carried out by a Panasonic Authorised Service Centre and only if valid proof of purchase is presented when the warranty service is requested.
3. This warranty only applies if the product has been installed and/or used in accordance with the manufacturer's recommendations (as noted in the operating instructions) under normal use and reasonable care (in the opinion of Panasonic). The warranty does not cover damage, malfunction or failure resulting from use of incorrect voltages, incorrect installation, accident, misuse, neglect, build-up of dirt or dust, abuse, maladjustment of customer controls, mains supply problems, thunderstorm activity, infestation by insects or vermin, tampering or repair by unauthorised persons (including unauthorised alterations), exposure to abnormally corrosive conditions, or any foreign object or matter having entered the product.
4. This warranty does not cover the following items unless the fault or defect existed at the time of purchase:
  - (a) Consumable parts
  - (b) Cosmetic parts
  - (c) Worn or damaged parts
  - (d) Information stored on Hard Disk Drives, Optical Discs, USB Devices, SD Cards, Tapes
  - (e) DTV reception issues caused by TV Aerial / Cabling / Wall socket(s)
5. Some products may be supplied with Ethernet connection hardware. The warranty is limited on such products and will not cover:
  - (a) Internet and or DLNA connection / setup related problems
  - (b) Access fees and or charges incurred for internet connection
  - (c) Incompatible software or software not specifically stipulated in the product operations manual; and
  - (d) Any indirect or consequential costs associated with the incorrect use or misuse of the hardware, its connection to the internet or any other device.
6. To claim warranty service, when required, you should:
  - Contact Panasonic's Customer Care Centre on 132 600 for Service Centre information.
  - Confirm the opening and acceptance times with the Authorised Service Centre that you choose.
  - Then send or take the product to a Panasonic Authorised Service Centre together with your proof of purchase receipt.
  - Any freight and insurance costs associated with the transport of the product to and/or from your nearest Authorised Service Centre must be arranged and paid for by you.
7. The warranties hereby conferred do not extend to, and exclude, any costs associated with the installation, de-installation or re-installation of a product, including costs related to the mounting, de-mounting or remounting of any screen, (and any other ancillary activities), delivery, handling, freighting, transportation or insurance of the product or any part thereof or replacement of and do not extend to, and exclude, any damage or loss occurring by reason of, during, associated with, or related to such installation, de-installation, re-installation or transit.

Panasonic Authorised Service Centres are located in major metropolitan areas and most regional centres of Australia, however, coverage will vary dependant on product. For advice on exact Authorised Service Centre locations for your product, please telephone our Customer Care Centre on 132 600 or visit our website and use the Service Centre Locator.

In addition to your rights under this warranty, Panasonic products come with consumer guarantees that cannot be excluded under the Australian Consumer Law. If there is a major failure with the product, you can reject the product and elect to have a refund or to have the product replaced or if you wish you may elect to keep the goods and be compensated for the drop in value of the goods. You are also entitled to have the product repaired or replaced if the product fails to be of acceptable quality and the failure does not amount to a major failure.

If there is a major failure in regard to the product which cannot be remedied then you must notify us within a reasonable period by contacting the Panasonic Customer Care Centre. If the failure in the product is not a major failure then Panasonic may choose to repair or replace the product and will do so in a reasonable period of time from receiving notice from you.

**THIS WARRANTY CARD AND THE PURCHASE DOCKET (OR SIMILAR PROOF OF PURCHASE)  
SHOULD BE RETAINED BY THE CUSTOMER AT ALL TIMES**

If you require assistance regarding warranty conditions or any other enquiries, please visit the  
**Panasonic Australia** website [www.panasonic.com.au](http://www.panasonic.com.au) or contact by phone on **132 600**  
*If phoning in, please ensure you have your operating instructions available.*

**Panasonic Australia Pty. Limited**

ACN 001 592 187 ABN 83 001 592 187  
1 Innovation Road, Macquarie Park NSW 2113  
[www.panasonic.com.au](http://www.panasonic.com.au)



