

Panasonic®

Operating Instructions Home Theater Audio System

Model No. SC-HTB688
SC-HTB498
SC-HTB488



Thank you for purchasing this product.

Please read these instructions carefully before using this product,
and save this manual for future use.

Included Installation Instructions

The installation work should be done by a qualified installation specialist. (⇒ 12 to 17)

Before commencing work, carefully read these installation instructions and the operating instructions to ensure that installation is performed correctly.

(Please keep these instructions. You may need them when maintaining or moving this system.)

Model number suffix “EB” denotes UK model.

EG EB GN

TQBJ2019-2

Safety precautions

WARNING

Unit

- To reduce the risk of fire, electric shock or product damage,
 - Do not expose this unit to rain, moisture, dripping or splashing.
 - Do not place objects filled with liquids, such as vases, on this unit.
 - Use only the recommended accessories.
 - Do not remove covers.
 - Do not repair this unit by yourself. Refer servicing to qualified service personnel.
- To prevent injury, this apparatus must be securely attached to the wall in accordance with the installation instructions.

AC mains lead

- To reduce the risk of fire, electric shock or product damage,
 - Ensure that the power supply voltage corresponds to the voltage printed on this unit.
 - Insert the mains plug fully into the socket outlet.
 - Do not pull, bend, or place heavy items on the lead.
 - Do not handle the plug with wet hands.
 - Hold onto the mains plug body when disconnecting the plug.
 - Do not use a damaged mains plug or socket outlet.
- The mains plug is the disconnecting device. Install this unit so that the mains plug can be unplugged from the socket outlet immediately.

Button-type battery (Lithium battery)

- Risk of fire, explosion and burns. Do not recharge, disassemble, heat above 60 °C or incinerate.
- If the button-type battery is swallowed, it can cause severe internal burns in just 2 hours and can lead to death.
- If the battery compartment does not close securely, stop using the remote control and keep it away from children.
- If you think batteries might have been swallowed or placed inside any part of the body, seek immediate medical attention.

Small object

- Keep the screws out of reach of children to prevent swallowing.
- Keep the button-type battery out of reach of children to prevent swallowing.
- Keep the screw eyes out of reach of children to prevent swallowing.

CAUTION

Unit

- Do not place sources of naked flames, such as lighted candles, on this unit.
- This unit may receive radio interference caused by mobile telephones during use. If such interference occurs, please increase separation between this unit and the mobile telephone.
- This unit is intended for use in moderate climates.
- Product Identification Marking is located on the bottom of the unit.

Placement

- Place this unit on an even surface.
- To reduce the risk of fire, electric shock or product damage,
 - Do not install or place this unit in a bookcase, built-in cabinet or in another confined space. Ensure this unit is well ventilated.
 - Do not obstruct this unit's ventilation openings with newspapers, tablecloths, curtains, and similar items.
 - Do not expose this unit to direct sunlight, high temperatures, high humidity, and excessive vibration.

Button-type battery (Lithium battery)

- Danger of explosion if battery is incorrectly replaced. Replace only with the type recommended by the manufacturer.
- Insert with poles aligned.
- Mishandling of batteries can cause electrolyte leakage and may cause a fire.
 - Remove the battery if you do not intend to use the remote control for a long period of time. Store in a cool, dark place.
 - Do not heat or expose to flame.
 - Do not leave the battery(ies) in a car exposed to direct sunlight for a long period of time with doors and windows closed.
- When disposing of the batteries, please contact your local authorities or dealer and ask for the correct method of disposal.

Caution for AC Mains Lead

(For the AC mains plug of three pins)

For your safety, please read the following text carefully.

This appliance is supplied with a moulded three pin mains plug for your safety and convenience.

A 5-ampere fuse is fitted in this plug.

Should the fuse need to be replaced please ensure that the replacement fuse has a rating of 5-ampere and that it is approved by ASTA or BSI to BS1362.

Check for the ASTA mark  or the BSI mark  on the body of the fuse.

If the plug contains a removable fuse cover you must ensure that it is refitted when the fuse is replaced.

If you lose the fuse cover the plug must not be used until a replacement cover is obtained.

A replacement fuse cover can be purchased from your local dealer.

Before use

Remove the connector cover.

How to replace the fuse

The location of the fuse differ according to the type of AC mains plug (figures A and B). Confirm the AC mains plug fitted and follow the instructions below. Illustrations may differ from actual AC mains plug.

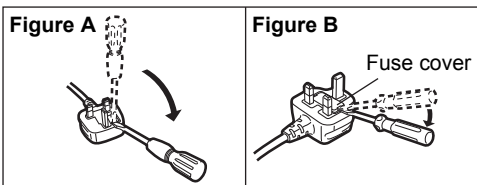

1. Open the fuse cover with a screwdriver.

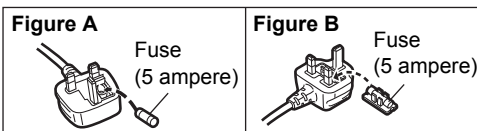

2. Replace the fuse and close or attach the fuse cover.



The symbols on this product (including the accessories) represent the following:

~	AC
	Class II equipment (The construction of the product is double-insulated.)
I	On
	Standby

Safety information for customers in Norway

NORSK

ADVARSEL

Produkt

- For å redusere faren for brann, elektrisk støt eller skade på apparatet:
 - Utsett ikke produktet for regn, fukt, drypping eller sprut.
 - Ikke plasser objekter som er fylt med væske, som vaser, på apparatet.
 - Bruk kun anbefalt tilbehør.
 - Fjern ikke deksler.
 - Reparer ikke denne enheten selv, overlatt service til kvalifisert servicepersonell.

Vekselstrømnett

- Nettstøpselet er trukket ut fra denne enheten. Installer denne enheten slik at nettstøpselet umiddelbart kan trekkes fra stikkontakten.

FORSIKTIG

Produkt

- Plasser ikke åpen ild, slik som levende lys, oppå apparatet.
- Dette apparatet er beregnet for bruk under moderate klimaforhold.

Plassering

- For å redusere faren for brann, elektrisk støt eller skade på apparatet:
 - Ikke plasser apparatet i en bokhylle, et innebygget kabinett eller et annet lukket sted. Pass på at produktet er godt ventilert.
 - Apparatets ventilasjonsåpninger må ikke dekkes til med aviser, duker, gardiner eller lignende.

- Operations in this operating instructions are described mainly with the remote control, but you can perform the operations on the main unit if the controls are the same.
- **HTB688**: indicates features applicable to SC-HTB688 only.
- **HTB498**: indicates features applicable to SC-HTB498 only.
- **HTB488**: indicates features applicable to SC-HTB488 only.

Table of contents

Safety precautions.....	2
Caution for AC Mains Lead	3

Before use

Supplied items	5
This system	5
Accessories	5
Control reference guide	6
This system (Front)	6
This system (Rear)	7
Remote control	8

Getting started

Step 1 Connections	9
Connection with the TV	9
Connection to a 4K Ultra HD TV	10
AC mains lead connection	11
Step 2 Placement	12
Safety Precautions	12
The active subwoofer	12
Wireless interference	12
Selecting the placement method	13
When placing the main unit in a rack or on a table	14
When attaching the main unit to a wall	15
Step 3 Wireless connections	18
Active subwoofer wireless connection	18
Bluetooth® connection	18

Operations

Using this system	19
Advanced operations	20
“HDMI CEC”	22

Reference

Troubleshooting	23
Indicator illumination	25
Unit care	25
About Bluetooth®	26
Licenses	26
Specifications	27
Limited Warranty (ONLY FOR AUSTRALIA).....	31

Supplied items

This system

1 Main unit (speaker)

- (HTB688): SU-HTB688)
- (HTB498): SU-HTB498)
- (HTB488): SU-HTB488)

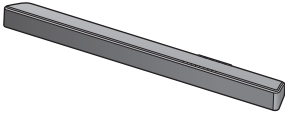

1 Active subwoofer

- (HTB688): SB-HWA688)
- (HTB498): SB-HWA488)
- (HTB488): SB-HWA488)

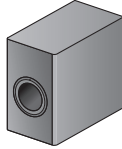

Accessories

Check the supplied accessories before using this system.

1 Remote control (with a battery) (N2QAYC000115)



2 Wall mount brackets (TEKL014, TEKL015)

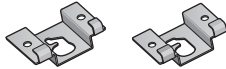

4 Screws (XYN5+J14FJK)

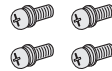

- Product numbers are correct as of December 2016. These may be subject to change.

Disposal of Old Equipment and Batteries

Only for European Union and countries with recycling systems



These symbols on the products, packaging, and/or accompanying documents mean that used electrical and electronic products and batteries must not be mixed with general household waste.

For proper treatment, recovery and recycling of old products and used batteries, please take them to applicable collection points in accordance with your national legislation.

By disposing of them correctly, you will help to save valuable resources and prevent any potential negative effects on human health and the environment.

For more information about collection and recycling, please contact your local municipality.

Penalties may be applicable for incorrect disposal of this waste, in accordance with national legislation.



Note for the battery symbol (bottom symbol):

This symbol might be used in combination with a chemical symbol. In this case it complies with the requirement set by the Directive for the chemical involved.

Control reference guide

This system (Front)

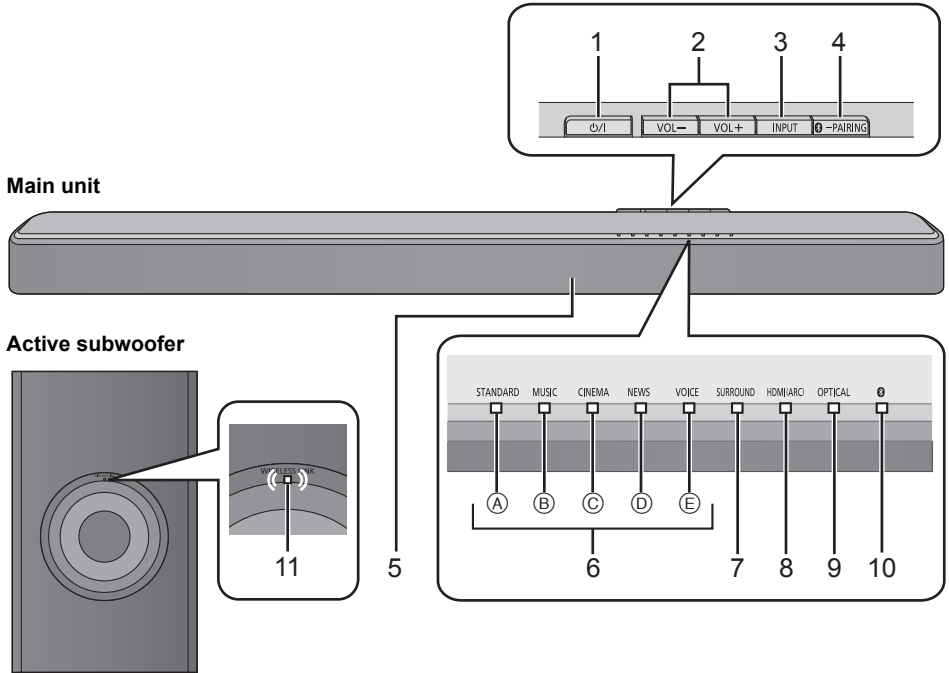

1 Standby/on switch (⏻/⏻)

Press to switch the unit from on to standby mode or vice versa. In standby mode, the unit is still consuming a small amount of power.

2 Adjust the volume of this system (⇒ 19)

3 Select the input source (⇒ 19)

"HDMI (ARC)" → "OPTICAL" → "Bluetooth" (Bluetooth®)

4 Select the Bluetooth® device as the source (⇒ 19)

Bluetooth® pairing (⇒ 18)

Disconnecting a Bluetooth® device (⇒ 18)

5 Remote control signal sensor

6 Sound mode indicators

Lights when the corresponding sound mode is selected

- (A) STANDARD indicator
- (B) MUSIC indicator
- (C) CINEMA indicator
- (D) NEWS indicator
- (E) VOICE indicator

7 SURROUND indicator

Lights when the surround effect is activated

8 HDMI (ARC) indicator

Lights when the device connected to the HDMI (ARC) terminal is the audio source

9 OPTICAL indicator

Lights when the device connected to the OPTICAL DIGITAL AUDIO IN terminal is the audio source

10 Bluetooth® indicator

Lights when the Bluetooth® device is the audio source

11 WIRELESS LINK indicator (⇒ 18)

This system (Rear)

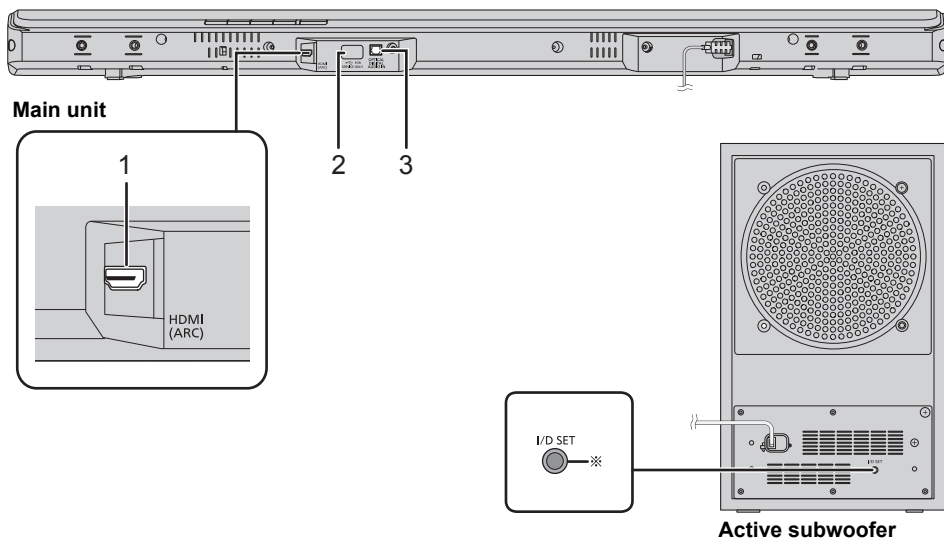

1 HDMI (ARC) terminal (ARC compatible)
(⇒ 9, 10)

2 USB port (for service use only)
3 OPTICAL DIGITAL AUDIO IN terminal (⇒ 10)

※ The I/D SET button is only used when the main unit is not paired with the active subwoofer. (⇒ 24)

Remote control

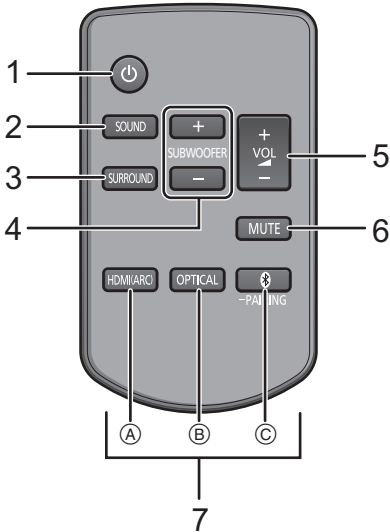

- 1 Turn the main unit on or off (⇒ 19)
- 2 Select the sound mode (⇒ 20)
- 3 Set the surround mode (⇒ 20)
- 4 Adjust the subwoofer level (⇒ 19)
- 5 Adjust the volume of this system (⇒ 19)
- 6 Mute the sound (⇒ 20)
- 7 Select the input source
 - Ⓐ Select the HDMI (ARC) device as the source (⇒ 19)
 - Ⓑ Select the Optical device as the source (⇒ 19)
 - Ⓒ Select the Bluetooth® device as the source (⇒ 19)
Bluetooth® pairing (⇒ 18)
Disconnecting a Bluetooth® device (⇒ 18)

■ Before using for the first time

Remove the insulation sheet **A**.

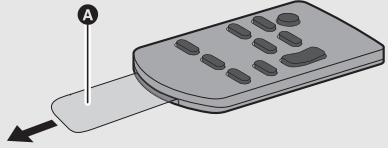

■ To replace a button-type battery

Battery type: CR2025 (Lithium battery)

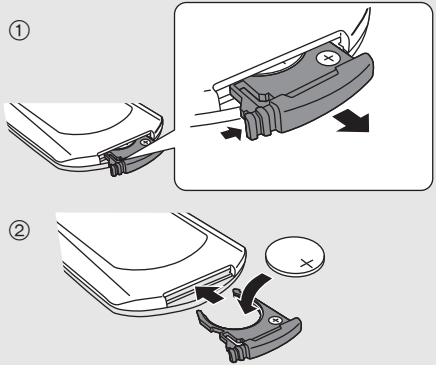

- Set the button-type battery with its (+) mark facing upward.

■ About remote control signal sensor

The remote control signal sensor is located on the main unit.

- Use the remote control within the correct operation range.
Distance: Within approx. 7 m directly in front
Angle: Approx. 30° left and right

Step 1 Connections

- Turn off all equipment before connection and read the appropriate operating instructions.
- Do not connect the AC mains lead until all other connections are completed.

■ HDMI (High-Definition Multimedia Interface)

- Use the ARC compatible High Speed HDMI Cables. Non-HDMI-compliant cables cannot be utilised.
- It is recommended that you use Panasonic's HDMI cable.

Connection with the TV

1 Verify if the TV's HDMI terminal is labelled "HDMI (ARC)".

Connection differs depending on the label printed next to the HDMI terminal.

Labelled "HDMI (ARC)": Connection **A**

Not Labelled "HDMI (ARC)": Connection **B**

■ What is ARC?

ARC is an abbreviation of Audio Return Channel, also known as HDMI ARC. It refers to one of the HDMI functions. When you connect the main unit to the terminal labelled "HDMI (ARC)" on the TV, the optical digital audio cable that is usually required in order to listen to sound from a TV is no longer required, and TV pictures and sound can be enjoyed with a single HDMI cable.

2 Make the connection.

A Labelled "HDMI (ARC)"

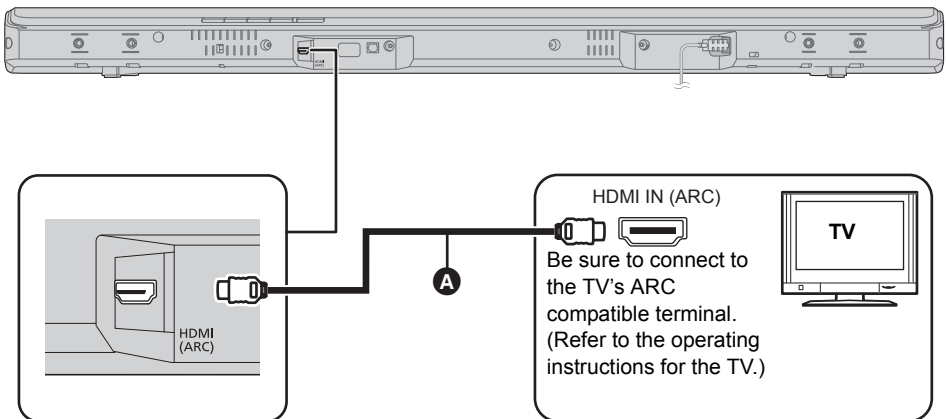

A HDMI cable

B Not labelled “HDMI (ARC)”

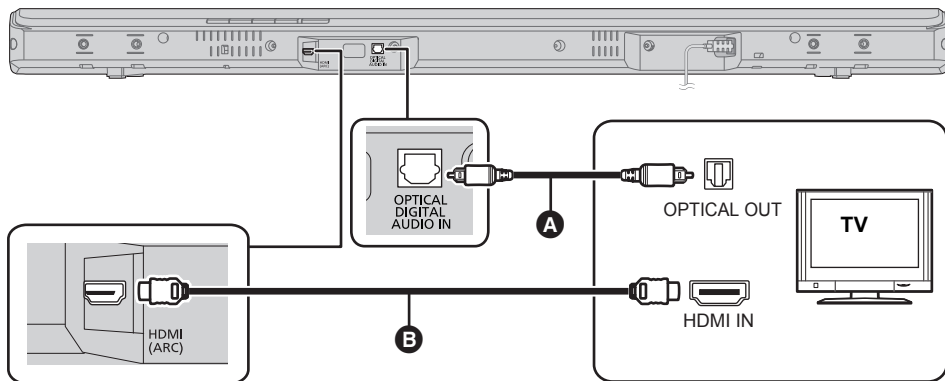

A Optical digital audio cable

- When you use the optical digital audio cable, insert the tip correctly into the terminal.

B HDMI cable

Connection to a 4K Ultra HD TV

This system cannot pass-through the 4K content of a 4K compatible equipment to a 4K Ultra HD TV. However, you can connect the system to a 4K Ultra HD TV to enjoy the 4K content.

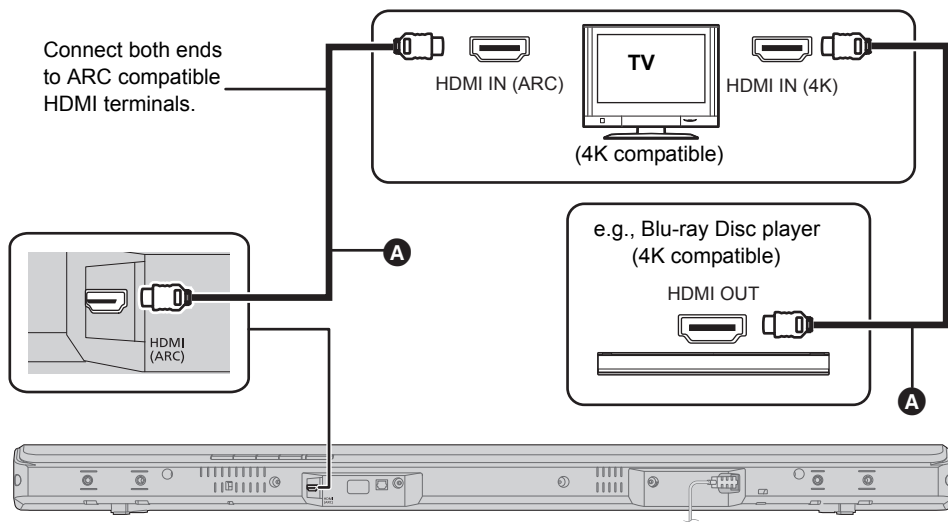

A HDMI cable



- Refer to the operating instructions of the 4K Ultra HD TV (VIERA) and the 4K/60p compatible equipment for setup and for playing the 4K content.
- To enjoy multi-channel output from this system, set the audio output of other equipment to Bitstream.
- The audio signal input to this system is up to 5.1 channels.

AC mains lead connection

- Connect only after all other connections are completed.

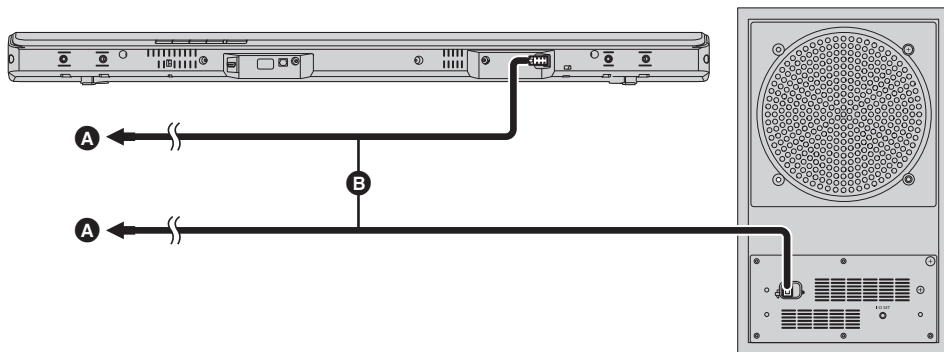

A To a household mains socket

B AC mains lead

- This system consumes a small amount of AC power (⇒ 27) even when it is turned off. In the interest of power conservation, if you will not be using this system for a long time, unplug it from the household mains socket.

Saving energy

The main unit is designed to conserve its power consumption and save energy.

- The main unit will automatically switch to standby mode when no signal is input and no operation is performed for approx. 20 minutes. Refer to page 21, "Auto power down" to turn this function off.

Step 2 Placement

Safety Precautions

Professional installation is required.

The installation should never be done by any other than a qualified installation specialist. PANASONIC DISCLAIMS ANY PROPERTY DAMAGE AND/OR SERIOUS INJURY, INCLUDING DEATH RESULTING FROM IMPROPER INSTALLATION OR INCORRECT HANDLING.

- Be sure to install the main unit as indicated within this operating instructions.
- Attach using techniques suited to the structure and materials of the installation location.

Caution

- This system is to be used only as indicated in these instructions. Failure to do so may lead to damage to the amplifier and/or the speaker, and may result in the risk of fire. Consult a qualified service person if damage has occurred or if you experience a sudden change in performance.
- Do not attempt to attach the main unit to a wall using methods other than those described in this manual.



- Do not hold the main unit in one hand to avoid injury, you may drop the main unit when carrying it.
- To prevent damage or scratches, lay down a soft cloth and perform the assembly on it.

The active subwoofer

When carrying the active subwoofer

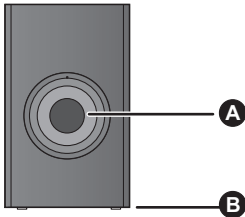

- A Do not hold the active subwoofer from this opening.**
The parts inside may get damaged.
- B Always hold the bottom of the active subwoofer when moving it.**

Wireless interference

To avoid interference, maintain the following distances between the main unit/active subwoofer and other electronic devices that use the same radio frequency (2.4 GHz band).

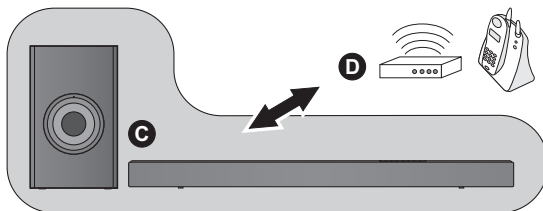

- C Main unit/active subwoofer**
- D Wireless router, cordless phone and other electronic devices: approx. 2 m**

Selecting the placement method

Choose a placement method that suits you best.

When placing the main unit in a rack or on a table

- Place the main unit on a flat and horizontal surface.

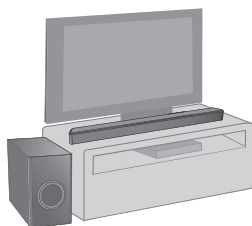

Page 14

When attaching the main unit to a wall

- Place the main unit on a flat and vertical surface.



Page 15

■ When placing the main unit in front of the TV

The main unit may block or interfere with the TV's various sensors (C.A.T.S. (Contrast Automatic Tracking System) sensor, remote control sensor, etc.) and the 3D Eyewear transmitters on a 3D compatible TV.

- If interference occurs, move the main unit further away from the TV. If the TV still does not function correctly, try using it in a rack or in the wall mount position.

■ If the TV's remote control sensor is blocked by the main unit

Try using the TV's remote control from a different angle.



- Place the active subwoofer within a few meters of the main unit and in a horizontal position with the top panel facing upward.
- Do not use the main unit or the active subwoofer in a metal cabinet.
- Depending on the position of the active subwoofer, the effect may vary. Placing the active subwoofer too close to the walls and corners can result in excessive bass. Cover walls and windows with thick curtains.

You may change the position of the active subwoofer, or adjust the subwoofer level (⇒ 19) to achieve optimum effect.

- If irregular colouring occurs on your TV, turn the TV off for about 30 minutes. If it persists, move the main unit and active subwoofer further away from the TV.
- Keep magnetised items away. Magnetised cards, watches, etc., can be damaged if placed too close to the main unit and active subwoofer.

When placing the main unit in a rack or on a table

Additionally required accessories (commercially available)

- Fall prevention cord × 2
- Screw eyes (to attach the fall prevention cord)..... × 2



- Use commercially available screws that are capable of supporting over 24 kg.
- Use a cord that is capable of supporting over 24 kg (with a diameter of about 1.5 mm).

1 Attach the cord to the main unit.

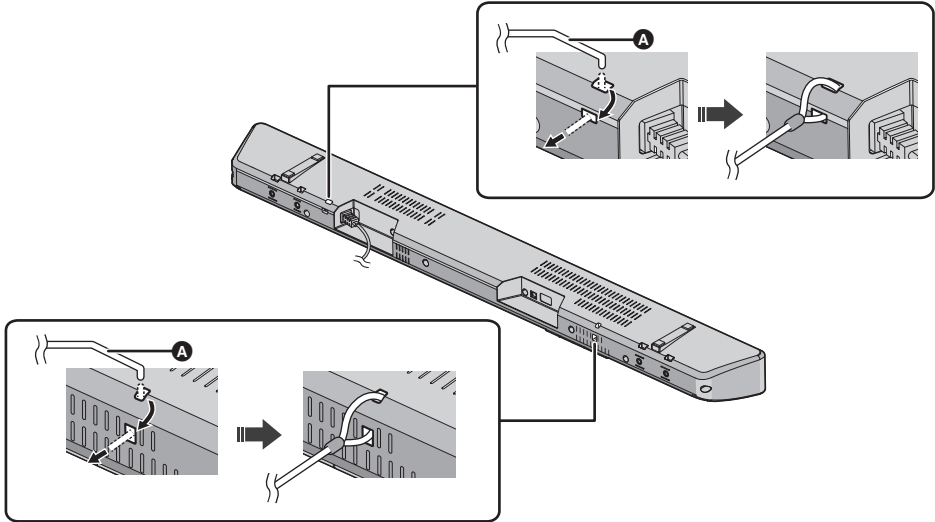

A Cord*

- ※ If the cord cannot be threaded through the holes, try bending the cord, about 5 mm apart from the tip, at an angle of 45° (as illustrated above).

2 Place the main unit in the desired position and attach each cord onto the rack or table.

- Make sure that the slack of the cord is minimal.
- Do not lean the main unit against the TV or wall.

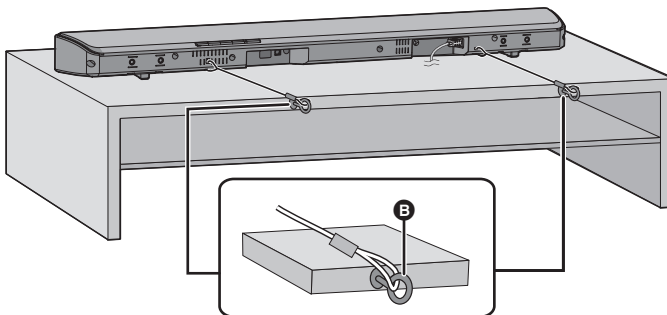

B Screw eye

- Attach at a position capable of supporting over 24 kg.
- Depending on the placement of the main unit, the screwing position of the screw eye may differ.

When attaching the main unit to a wall

The main unit can be wall mounted using the supplied wall mount brackets, etc. Make sure that the screw used and the wall are strong enough to support the weight of at least 24 kg.

The screws and other items are not supplied as the type and size will vary with each installation.

- Refer to step 3 for details about the required screws.
- Be sure to attach the fall prevention cord as a secondary safety measure.

Supplied accessories

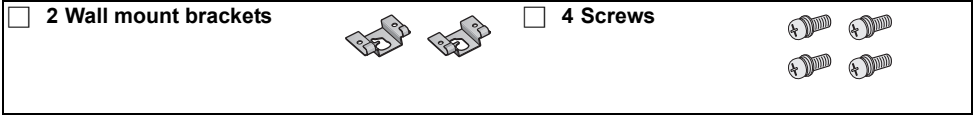

Additionally required accessories (commercially available)

- Screws for wall mounting × 2
- Fall prevention cord × 2
- Screw eyes (to attach the fall prevention cord) × 2



- Use a cord that is capable of supporting over 24 kg (with a diameter of about 1.5 mm).

1 Attach the cord to the main unit.

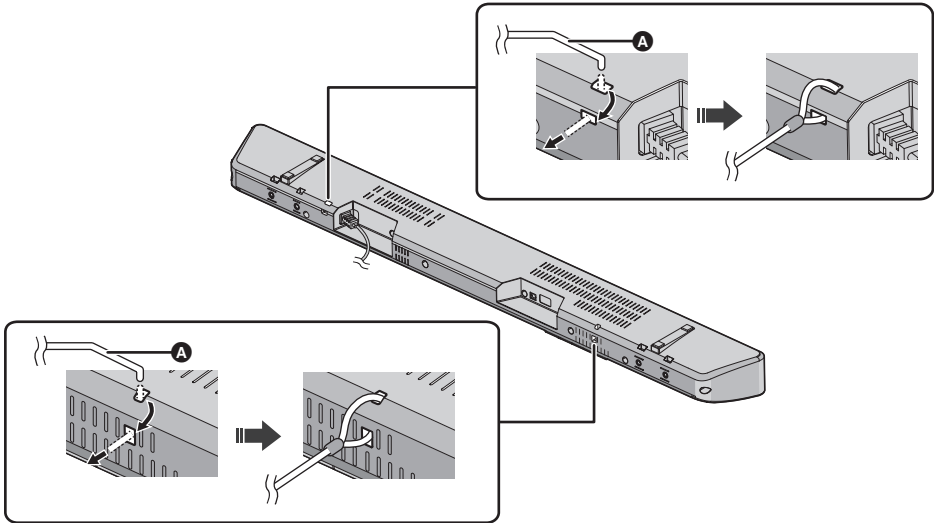

A Cord*

- ※ If the cord cannot be threaded through the holes, try bending the cord, about 5 mm apart from the tip, at an angle of 45° (as illustrated above).

2 Attach the wall mount brackets to the main unit.

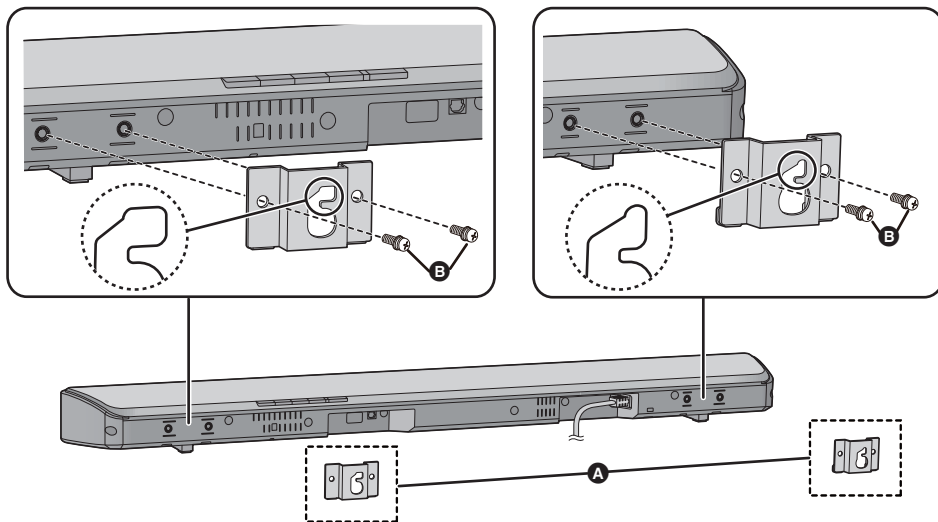

- A** Wall mount bracket (supplied)
- B** Screw (supplied)

3 Drive a screw into the wall.

- Use the measurements indicated below to identify the screwing positions on the wall.
- Leave at least 100 mm of space above of the main unit to allow enough space for fitting the main unit.
- Be sure to use a level to ensure that both mounting holes are level to each other.

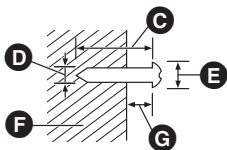

- C** At least 30 mm
- D** $\varnothing 4.0$ mm
- E** $\varnothing 7.0$ mm to $\varnothing 9.4$ mm
- F** Wall or pillar
- G** 2.5 mm to 3.5 mm

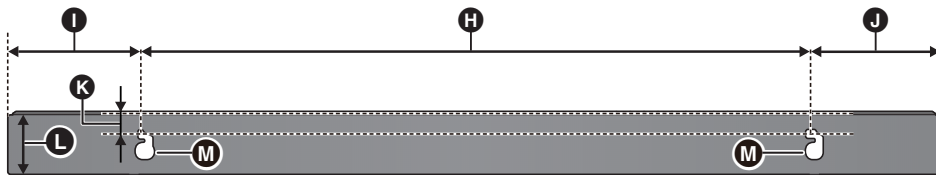

Front view (semi-transparent image)

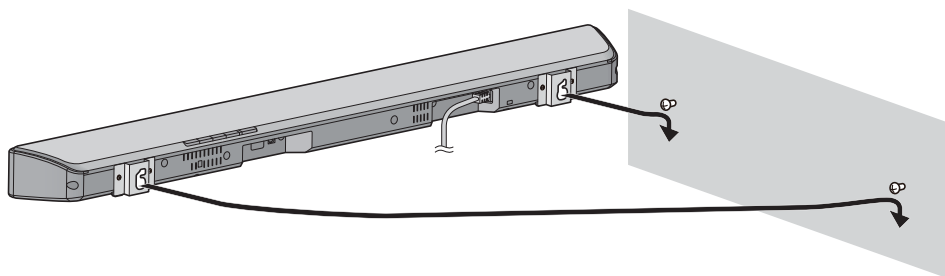

- H** 616 mm
- I** 118 mm
- J** 118 mm
- K** 28 mm
- L** 60.5 mm
- M** Wall mounting hole

4 Fit the main unit securely onto the screw(s).



DO	DO NOT
 <ul style="list-style-type: none">• Move the speaker so that the screw is in this position.	 <ul style="list-style-type: none">• In this position, the speaker will likely fall if moved to the left or right.

5 Secure the cord to the wall.

- Make sure that the slack of the cord is minimal.

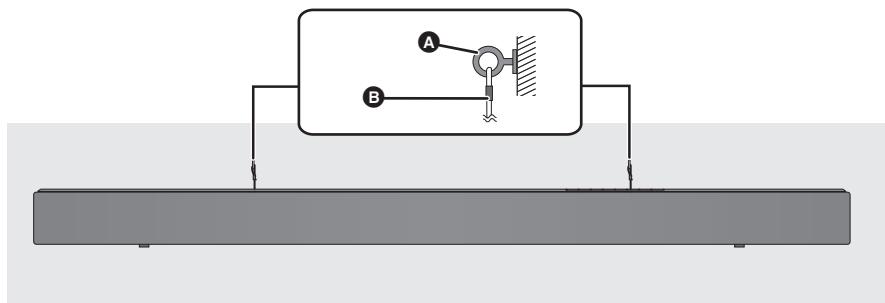

- A** Screw eye
- B** Cord

Step 3 Wireless connections

Active subwoofer wireless connection

Preparation

- Turn on the main unit.

Check that the wireless link is activated.

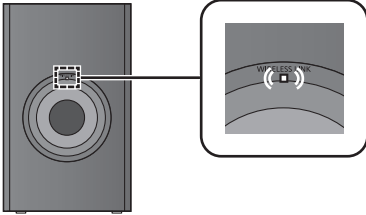

WIRELESS LINK indicator

Lights:

The wireless link is activated.

Lights off:

The wireless link is not activated.

Blinks:

The active subwoofer is trying to activate the wireless link with the main unit.



- The wireless link will be activated when the main unit and the active subwoofer are both turned on.
- The I/D SET button is only used when the main unit is not paired with the active subwoofer. (⇒ 24)

Bluetooth® connection

By using the Bluetooth® connection, you can listen to the sound from the Bluetooth® audio device from this system wirelessly.

- Refer to the operating instructions of the Bluetooth® device for further instruction on how to connect a Bluetooth® device.

Preparation

- Turn on the Bluetooth® feature of the device and place the device near the main unit.

Bluetooth® pairing

1 Press [-PAIRING] to select “ ”.

- If the “  ” indicator starts blinking quickly, go to step 3.

2 Press and hold [-PAIRING] until the “ ” indicator blinks quickly.

- If the “  ” indicator blinks slowly, repeat step 2.

3 Select “SC-HTB688”, “SC-HTB498” or “SC-HTB488” from the Bluetooth® device’s Bluetooth® menu.

- The MAC address (e.g., 6C:5A:B5:B3:1D:0F) may be displayed before “SC-HTB688”, “SC-HTB498” or “SC-HTB488” is displayed.
- If prompted for the passkey on the Bluetooth® device, enter “0000” or “1234”.
- Once the Bluetooth® device is connected, the “  ” indicator stops blinking and lights up.



- You can register up to 8 devices with this system. If a 9th device is paired, the device that has not been used for the longest time will be replaced.

Connecting a paired Bluetooth® device

1 Press [-PAIRING] to select “ ”.

- If the “  ” indicator lights, a Bluetooth® device is already connected with this system. Disconnect it. (⇒ below)

2 Select “SC-HTB688”, “SC-HTB498” or “SC-HTB488” from the Bluetooth® device’s Bluetooth® menu.

■ **Disconnecting a Bluetooth® device**
Press and hold [ -PAIRING] until the “  ” indicator blinks slowly.



- When “  ” is selected as the source, this system will automatically try and connect to the last connected Bluetooth® device. If the connection attempt fails, try to establish a connection again.
- The Bluetooth® device will be disconnected if a different audio source (e.g. “HDMI (ARC)”) is selected.
- This system can only be connected to one device at a time.

Using this system

- The default setting is underlined. Changed settings will be kept until it is changed again, unless otherwise indicated.

Preparation

- Turn on the TV and/or connected device.

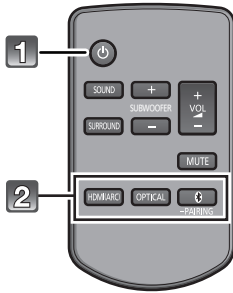

1 Press [⏻] to turn on the main unit.

2 Select the source.

Main unit

Press	To select
[INPUT]	"HDMI (ARC)" → "OPTICAL" ↑ "Bluetooth" (Bluetooth®) ↓
[Bluetooth -PAIRING]	"Bluetooth" (Bluetooth®)

Remote control

Press	To select
[HDMI (ARC)]	"HDMI (ARC)"
[OPTICAL]	"OPTICAL"
[Bluetooth -PAIRING]	"Bluetooth" (Bluetooth®)

- This remote control cannot be used to control the operations of the connected devices.

■ When "Bluetooth" is selected as the source

On the Bluetooth® device:

Select this system as the output source of the connected Bluetooth® device and start the playback.

■ When "OPTICAL" is selected as the source

On the TV and the connected device:

Select the TV's input for this system and start the playback on the connected device.

■ To adjust the volume of this system

Press [+ VOL -].

- Volume range: 0 to 100

The indicators will scroll every time the volume is adjusted.

- The indicators will not blink when it has reached the maximum or minimum.



■ To adjust the subwoofer level

1 Press [+ SUBWOOFER] or [SUBWOOFER -] to display the current level.

2 While the level is displayed:

Press [+ SUBWOOFER] or [SUBWOOFER -] to adjust the level.

Indication	Effect level	
STANDARD MUSIC CINEMA NEWS VOICE [Indicators: 5 bars lit]	5	Highest
STANDARD MUSIC CINEMA NEWS VOICE [Indicators: 4 bars lit]	4	
STANDARD MUSIC CINEMA NEWS VOICE [Indicators: 3 bars lit]	<u>3</u>	
STANDARD MUSIC CINEMA NEWS VOICE [Indicators: 2 bars lit]	2	
STANDARD MUSIC CINEMA NEWS VOICE [Indicators: 1 bar lit]	1	Lowest

■ To select the sound mode

Press [SOUND].

Sound mode	
<u>STANDARD</u>	Best suited for dramas and comedy shows.
MUSIC	Enhance the sound of musical instruments and songs.
CINEMA	Produces three-dimensional sound unique to movies.
NEWS	Enhance the voice of news and sports commentaries.
VOICE	Enhance the clearness when listening to human voice.

■ To set the surround mode

You can enable/disable the surround effect.

Press [SURROUND].

- To cancel, press the button again.

■ To mute the sound

Press [MUTE].

- While muting, the sound mode indicators blink simultaneously.
- To cancel, press the button again or adjust the volume.
- Muting is cancelled if the main unit is turned off.



If this system does not operate as expected or sound is unusual, returning the settings to the factory preset may solve the problem. (⇒ 23)

- If there is sound coming out of the TV's speakers, reduce the volume of the TV to its minimum.

Advanced operations

- The default setting is underlined. Changed settings will be kept until it is changed again, unless otherwise indicated.

Dual audio

Sets the preferred audio channel mode when there are two audio modes received by this system.

Press and hold [MUTE] for more than 4 sec.

Depending on the audio mode, the indicator will blink as below.

Audio mode	Indicator
<u>Main</u>	
Secondary	
Main +Secondary	

- This effect only works if the audio output of the TV or player is set to "Bitstream" and "Dolby Dual Mono" is available in the sound source.
- The indicator for the selected setting blinks for 5 sec. and then exits the setting mode.

Audio format

You can view the current audio format.

Press and hold [SOUND] for more than 4 sec.

Depending on the audio format, the indicator will blink as below.

Audio format	Indicator
Dolby Digital	
DTS®	
PCM	

- The indicator for the selected setting blinks for 5 sec. and then exits the setting mode.
- The indicators may work differently if the main unit detects an unsupported audio format from the connected TV.



- Audio format is not indicated when " " is selected as the source.

Auto power down

The main unit is automatically turned off if there is no audio input and when you do not use it for approx. 20 minutes.

Press and hold [HDMI (ARC)] for more than 4 sec. to select the mode.

Depending on the mode, the indicator will blink as below.

Mode	Indicator
<u>On</u>	
<u>Off</u>	

- The indicator for the selected setting blinks for 5 sec. and then exits the setting mode.
- The setting is maintained until it is changed again.

Bluetooth® standby

This function allows you to connect a paired Bluetooth® device when the main unit is in standby mode.

Press and hold [OPTICAL] for more than 4 sec. to select the mode.

Depending on the mode, the indicator will blink as below.

Mode	Indicator
<u>On</u>	
<u>Off</u>	

- The indicator for the selected setting blinks for 5 sec. and then exits the setting mode.
- The setting is maintained until it is changed again.
- If the AC mains lead is unplugged, the Bluetooth® standby function may not work. Make the setting again.

Dimmer mode

You can turn off dimmer mode and keep the LED indicators bright.

Press and hold [SURROUND] for more than 4 sec. to turn off the mode.

- The indicator for the current condition will turn brighter.
- The setting is maintained until it is changed again.
- Default setting of this function is on.



- To turn on dimmer mode, repeat the operation above. After performing the operation, the indicator for the current condition will be dim.

Volume limitation

If a state of the lowered volume disturbs you every time the main unit turns on, for example, it is possible to turn off this function as follows:

Press [SURROUND], [SOUND]*, [SURROUND]*, [SOUND]* consecutively.

* Within 3 sec.

Depending on the mode, the indicator will blink as below.

Mode	Indicator
<u>On</u>	
<u>Off</u>	

- To turn on Volume limitation, repeat the operation above.

Remote control code

When other Panasonic devices respond to this system's remote control, change the remote control code on this system and the remote control.

Preparation

- Turn off all other Panasonic products.
- Turn on the main unit.

■ To set the code to code 2

- 1 Aim the remote control at the main unit's remote control signal sensor.
- 2 Press and hold [SOUND] and [Bluetooth]-PAIRING on the remote control for more than 4 sec.

Depending on the mode, the indicator will blink as below.

Code	Indicator
<u>Code 1</u>	
<u>Code 2</u>	

- To select the code 1, press and hold [SOUND] and [OPTICAL] for more than 4 sec.

“HDMI CEC”

This unit supports “HDMI CEC” (Consumer Electronics Control) function.

See the operating instructions for connected equipment for operational details.

Preparation

Confirm that the HDMI connection has been made. (⇒ 9, 10)

Power on link

When the TV is turned on, the main unit also turns on automatically. (This function does not work when OPTICAL or Bluetooth® is the source.)

Power off link

When the TV is turned off, the main unit also turns off automatically. (This function does not work when OPTICAL or Bluetooth® is the source.)

Volume adjustment

You can control the volume setting of this system using the volume or mute button on the TV remote control.

If the main unit's speakers are changed to the TV speakers, the main unit's speakers are muted. Muting will be cancelled by selecting the main unit's speakers again.

Changing speakers

When the main unit turns on, the TV speakers will be automatically changed to the main unit's speakers.

When the main unit turns off, the main unit's speakers will be automatically changed to the TV speakers.





- The operation cannot be guaranteed on all HDMI CEC equipment.

Troubleshooting

Before requesting service, make the following checks. If you are in doubt about some of the check points, or if the solutions indicated in the following guide do not solve the problem, consult your dealer for instructions.

To return to the factory preset.

- ① Turn on the main unit.
- ② Press [ -PAIRING] to select “  ”.
- ③ Press and hold [ / I] on the main unit for more than 4 sec.

(All the indicators will blink until the system restarts)

If this system does not operate as expected, returning the settings to the factory preset may solve the problem.

- The remote control code will return to the code 1 when this system is returned to the factory preset. To change the remote control code, refer to page 21.

General operation

No power.

- After connecting the AC mains lead, wait about 10 sec. before turning on the unit.
- Unplug the AC mains lead for 10 sec. before plug in again.
- After turning the main unit on, if the main unit immediately turns off, unplug the AC mains lead and consult your dealer.
- If the main unit does not turn on by turning on TV (HDMI CEC), turn on the main unit manually.

The remote control does not work properly.

- The battery is depleted. Replace it with a new one. (⇒ 8)
- It is possible that the insulation sheet has not been removed. Remove the insulation sheet. (⇒ 8)
- It may be necessary to set the code of the remote control again after changing the battery of the remote control. (⇒ 21)
- Use the remote control within the correct operation range. (⇒ 8)

The main unit is automatically switched to standby mode.

“Auto power down” function is on.

The main unit will automatically switch to standby mode when no signal is input and no operation is performed for approx. 20 minutes. Refer to page 21 to turn this function off.

HDMI

HDMI CEC related operations no longer function properly.

- Check the setting on the connected devices.
 - Turn on HDMI CEC function on the connected devices.
 - Select this system as the speaker in the TV’s HDMI CEC menu.
- When the HDMI connections are changed, after a power failure or after the AC mains lead has been unplugged, HDMI CEC operations may not function properly.
 - Turn on all the devices that are connected to the TV with an HDMI cable and then turn the TV on.
 - Turn off the HDMI CEC settings of the TV and turn it on again. For details refer to the operating instructions for the TV.
 - While the main unit and the TV are connected with the HDMI cable, turn on the TV and then unplug the main unit’s AC mains lead and plug it again.

Bluetooth®

Pairing cannot be done.

Check the Bluetooth® device condition.

The device cannot be connected.

- The pairing of the device was unsuccessful or the registration has been replaced. Try pairing the device again. (⇒ 18)
- This system might be connected to a different device. Disconnect the other device and try pairing the device again.

The device is connected but audio cannot be heard through this system.

For some built-in Bluetooth® devices, you have to set the audio output to “SC-HTB688”, “SC-HTB498” or “SC-HTB488” manually. Read the operating instructions for the device for details.

The sound is interrupted.

- The device is out of the 10 m communication range. Bring the Bluetooth® device closer to the main unit.
- Remove any obstacle between the main unit and the device.
- Other devices that use the 2.4 GHz frequency band (wireless router, microwaves, cordless phones, etc.) are interfering. Bring the Bluetooth® device closer to the main unit and distance it from the other devices.

If the above does not fix the problem, you may be able to fix the problem by reconnecting the main unit and the Bluetooth® device. (⇒ 18)

Sound

No sound (or image).

- Turn muting off. (⇒ 20)
- Check the connections to the other devices. (⇒ 9, 10)
- Make sure that the received audio signal is compatible with this system. (⇒ 27)
- Turn this system off and then on again.
- If the main unit is connected to the TV with only an HDMI cable, make sure that the TV's HDMI terminal is labelled "HDMI (ARC)". If not, connect using the optical digital audio cable. (⇒ 9, 10)
- If the connections are correct, there might be a problem with the cables. Redo the connections with different cables.
- Check the audio output settings on the connected device.

The dual audio cannot be changed from main to secondary.

If the audio received from the connected device is not "Dolby Dual Mono" or the output setting is not "Bitstream", the setting cannot be changed from this system. Change the setting on the connected device.

The volume is lowered when the main unit is turned on.

"Volume limitation" is on.

If the main unit is turned off with the volume setting in the greater half (above 50), the main unit will automatically lower the volume to the middle (50) when the main unit is turned on. (⇒ 21)

The sound lags behind the image.

Depending on the TV, when this unit is connected to it via Bluetooth®, the sound output from this unit may lag behind the TV image. Connect this unit and the TV with an HDMI cable/optical digital audio cable. (⇒ 9, 10)

The audio format indicator does not correspond to the playback source.

If the playback source is Dolby Digital or DTS®, set the audio output setting of the connected equipment (e.g., TV, player) to bitstream. For details, refer to the operating instructions for the connected equipment.

There is no audio.

The power of the main unit turns off automatically.

(When the main unit detects a problem, a safety measure is activated and the main unit automatically switches to standby mode.)

- There is a problem with the amplifier.
- Is the volume extremely high?
If so, lower the volume.
- Is this system placed in an extremely hot place?
If so, move this system to a cooler place and wait a few moments and then try to turn it on again.
- Does the "SURROUND" indicator keep blinking?
If so, temperature of this unit is hot. Wait until its temperature becomes low and the blinking stops.

If the problem persists, confirm the indicator status, turn this system off, unplug the AC mains lead and consult your dealer. Please be sure to remember the indicator status and inform the dealer.

Active Subwoofer

No power.

Ensure the AC mains lead of the active subwoofer is connected properly.

After turning the subwoofer on, it immediately turns off.

Unplug the AC mains lead and consult your dealer.

No sound from the subwoofer.

- Check that the active subwoofer is turned on.
- Check that the WIRELESS LINK indicator lights. (⇒ 18)

The WIRELESS LINK indicator does not light.

- There is no link between the main unit and the active subwoofer.
Check that the main unit is turned on.
- The active subwoofer and the main unit may not be paired correctly. Try the following operation. (Wireless pairing)
 - ① Turn on the main unit.
 - ② Press and hold [I/D SET] on the rear of the active subwoofer for more than 3 sec. (The wireless link indicator will blink.)
 - ③ Press [MUTE], [SOUND]*, [MUTE]*, [HDMI (ARC)]* consecutively.
* Within 3 sec.
("⊗" , "OPTICAL" and "HDMI (ARC)" indicators will blink in rotation on the main unit.)

When the wireless pairing is successful, "⊗", "OPTICAL" and "HDMI (ARC)" indicators will turn off. Consult your dealer if the problem persists.

Indicator illumination

The indicators display the condition of this system by blinking. The indicator patterns illustrated below are displayed during normal operational conditions. They do not refer to the indications of a problem.

Indicator	Description
	<p>The indicator blinks for 5 sec.</p> <ul style="list-style-type: none"> When the setting is on (“Auto power down”, “Bluetooth® standby” and “Volume limitation”) (⇒ 21) When the audio format is Dolby Digital (⇒ 20)
	<p>The indicator blinks for 5 sec.</p> <ul style="list-style-type: none"> When the setting is off (“Auto power down”, “Bluetooth® standby” and “Volume limitation”) (⇒ 21) When the audio format is PCM (⇒ 20)
	<p>The indicator blinks for 5 sec.</p> <ul style="list-style-type: none"> When the audio format is DTS® (⇒ 20)
	<p>The indicator blinks for 10 sec.</p> <ul style="list-style-type: none"> When the remote control is code 1 (⇒ 21) <p>The indicator blinks for 5 sec.</p> <ul style="list-style-type: none"> When the dual audio is main (⇒ 20)
	<p>The indicator blinks for 5 sec.</p> <ul style="list-style-type: none"> When the dual audio is secondary (⇒ 20)
	<p>The indicators blink for 5 sec.</p> <ul style="list-style-type: none"> When the dual audio is main+secondary (⇒ 20)
	<p>The indicators blink for 10 sec.</p> <ul style="list-style-type: none"> When the remote control is code 2 (⇒ 21)
	<p>The indicators blink until the system restarts.</p> <ul style="list-style-type: none"> When the main unit is reset (⇒ 23) <p>The indicators blink continuously.</p> <ul style="list-style-type: none"> When the sound is muted (⇒ 20) <p>The indicators blink 10 times.</p> <ul style="list-style-type: none"> When active subwoofer is failed to connect (⇒ 24)
	<p>Bluetooth® indicator blinks quickly.</p> <ul style="list-style-type: none"> When the main unit is ready for pairing (⇒ 18) <p>Bluetooth® indicator blinks slowly.</p> <ul style="list-style-type: none"> When the main unit is waiting to connect (⇒ 18) <p>Bluetooth® indicator turns on.</p> <ul style="list-style-type: none"> When the main unit is connected with a Bluetooth® device (⇒ 18)

Unit care

■ Clean this system with a soft, dry cloth

- When dirt is heavy, wring a cloth moistened in water tightly to wipe the dirt, and then wipe it with a dry cloth.
- When cleaning the speakers, use a fine cloth. Do not use tissues or other materials (towels, etc.) that can fall apart. Small grains may get stuck inside the speaker cover.
- Never use alcohol, paint thinner or benzine to clean this system.
- Before using chemically-treated cloth, carefully read the instructions that came with the cloth.

■ To dispose or transfer this system

- This system may keep the user settings information in the main unit. If you discard the main unit either by disposal or transfer, then follow the procedure to return all the settings to the factory presets to delete the user settings. (⇒ 23, “To return to the factory preset.”)
- The operation history may be recorded in the memory of the main unit.

About Bluetooth®

Panasonic bears no responsibility for data and/or information that is compromised during a wireless transmission.

■ Frequency band used

This system uses the 2.4 GHz frequency band.

■ Certification of this device

- This system conforms to frequency restrictions and has received certification based on frequency laws. Thus, a wireless permit is not necessary.
- The actions below are punishable by law in some countries:
 - Taking apart or modifying the unit.
 - Removing specification indications.

■ Restrictions of use

- Wireless transmission and/or usage with all Bluetooth® equipped devices is not guaranteed.
- All devices must conform to standards set by Bluetooth SIG, Inc.
- Depending on the specifications and settings of a device, it can fail to connect or some operations can be different.
- This system supports Bluetooth® security features. But depending on the operating environment and/or settings, this security is possibly not sufficient. Transmit data wirelessly to this system with caution.
- This system cannot transmit data to a Bluetooth® device.

■ Range of use

Use this device at a maximum range of 10 m. The range can decrease depending on the environment, obstacles or interference.

■ Interference from other devices

- This system may not function properly and troubles such as noise and sound jumps may arise due to radio wave interference if the main unit is located too close to other Bluetooth® devices or the devices that use the 2.4 GHz band.
- This system may not function properly if radio waves from a nearby broadcasting station, etc. are too strong.

■ Intended usage

- This system is for normal, general use only.
- Do not use this system near equipment or in an environment that is sensitive to radio frequency interference (example: airports, hospitals, laboratories, etc.).

Licenses

Dolby, Dolby Audio, and the double-D symbol are trademarks of Dolby Laboratories.

For DTS patents, see <http://patents.dts.com>. Manufactured under license from DTS Licensing Limited. DTS, the Symbol, & DTS and the Symbol together are registered trademarks, and DTS Digital Surround is a trademark of DTS, Inc. © DTS, Inc. All Rights Reserved.

The terms HDMI and HDMI High-Definition Multimedia Interface, and the HDMI Logo are trademarks or registered trademarks of HDMI Licensing, LLC in the United States and other countries.

The Bluetooth® word mark and logos are registered trademarks owned by Bluetooth SIG, Inc. and any use of such marks by Panasonic Corporation is under license. Other trademarks and trade names are those of their respective owners.

Specifications

AMPLIFIER SECTION

RMS output power: Dolby Digital Mode

HTB688

Front ch (L, R ch)

60 W per channel (6 Ω), 1 kHz, 10% THD

Centre ch (C ch)

60 W per channel (6 Ω), 1 kHz, 10% THD

Subwoofer ch

120 W per channel (3 Ω), 100 Hz, 10% THD

Total RMS Dolby Digital mode power

300 W

HTB498

Front ch (L, R ch)

45 W per channel (6 Ω), 1 kHz, 10% THD

Subwoofer ch

90 W per channel (3 Ω), 100 Hz, 10% THD

Total RMS Dolby Digital mode power

180 W

HTB488

Front ch (L, R ch)

50 W per channel (6 Ω), 1 kHz, 10% THD

Subwoofer ch

100 W per channel (3 Ω), 100 Hz, 10% THD

Total RMS Dolby Digital mode power

200 W

TERMINAL SECTION

HDMI output (ARC)

Output connector

Type A (19 pin)

Digital audio input

1

Optical digital input

Optical terminal

Sampling frequency

32 kHz, 44.1 kHz, 48 kHz

Audio format

LPCM, Dolby Digital, DTS Digital Surround™

USB Port

For service use only.

GENERAL

Power consumption

HTB688

Main unit

30 W

Active subwoofer

20 W

HTB498 **HTB488**

Main unit

19 W

Active subwoofer

18 W

In standby condition

Main unit

When Bluetooth® standby is off

Approx. 0.5 W

When Bluetooth® standby is on

Approx. 2 W

When all wired network ports are connected and all wireless networks are activated in network standby:

HTB688

Approx. 6.2 W

HTB498 **HTB488**

Approx. 5.1 W

Active subwoofer

Approx. 0.5 W

HTB688

When wireless activated in network standby

Approx. 3 W

HTB498 **HTB488**

When wireless activated in network standby

Approx. 2.3 W

Power supply

AC 220 V to 240 V, 50 Hz

Dimensions (W×H×D)

Main unit

For table top layout

853 mm×60.5 mm×90 mm

For wall mounting layout

853 mm×60.5 mm×111 mm

Active subwoofer

185 mm×303 mm×337 mm

Mass

Main unit

HTB688

For table top layout

Approx. 2.3 kg

For wall mounting layout

Approx. 2.4 kg

HTB498 **HTB488**

For table top layout

Approx. 1.9 kg

For wall mounting layout

Approx. 2.0 kg

Active subwoofer

Approx. 4.8 kg

Operating temperature range

0 °C to +40 °C

Operating humidity range

20% to 80% RH (no condensation)

SPEAKER SECTION

Front speakers (Built-in)	
Full range	4.5 × 12 cm (Cone type) × 1/ch
Centre speaker (Built-in)	HTB688
Full range	4.5 × 12 cm (Cone type) × 1
Active subwoofer	
Woofer	16 cm cone type × 1

WIRELESS SECTION

Wireless module	
Frequency Range	2404 MHz to 2478 MHz
Maximum RF Power	-0.09 dBm
No. of channels	38

Bluetooth® SECTION

Version	Bluetooth® Ver.4.0
Class	Class 2
Supported profiles	A2DP
Operating frequency	2402 MHz to 2480 MHz
Maximum RF Power	7.1 dBm
Operating distance	10 m Line of Sight



- Specifications are subject to change without notice.
- Mass and dimensions are approximate.
- Total harmonic distortion is measured by a digital spectrum analyzer.



English

Declaration of Conformity (DoC)

Hereby, "Panasonic Corporation" declares that this product is in compliance with the essential requirements and other relevant provisions of Directive 2014/53/EU.

Customers can download a copy of the original DoC to our RE products from our DoC server:

<http://www.doc.panasonic.de>

Contact to Authorised Representative: Panasonic Marketing Europe GmbH,

Panasonic Testing Centre, Winsbergring 15, 22525 Hamburg, Germany

Ελληνικά

Δήλωση συμμόρφωσης (DoC)

Με την παρούσα, η "Panasonic Corporation" δηλώνει ότι το προϊόν αυτό είναι σύμφωνο με τις βασικές απαιτήσεις και άλλες σχετικές διατάξεις της οδηγίας 2014/53/ΕΕ.

Οι πελάτες μπορούν να κατεβάσουν ένα αντίγραφο του πρωτοτύπου DoC για τα RE προϊόντα μας από τον DoC server μας:

<http://www.doc.panasonic.de>

Στοιχεία επικοινωνίας Εξουσιοδοτημένου Αντιπροσώπου:

Panasonic Marketing Europe GmbH,
Panasonic Testing Centre, Winsbergring 15, 22525 Hamburg, Γερμανία

Português

Declaração de Conformidade (DoC)

Com o presente documento, a "Panasonic Corporation" declara que este produto é conforme os requisitos específicos e demais especificações referentes à Directriz 2014/53/UE.

Os clientes podem baixar uma cópia da declaração de conformidade (DoC) para nossos produtos RE do Server DoC:

<http://www.doc.panasonic.de>

Contacte o representante autorizado: Panasonic Marketing Europe GmbH,

Panasonic Testing Centre, Winsbergring 15, 22525 Hamburg, Alemanha

Česky

Prohlášení o shodě

Společnost "Panasonic Corporation" tímto prohlašuje, že tento výrobek je ve shodě se základními požadavky a dalšími příslušnými ustanoveními směrnice 2014/53/EU.

Zákazníci si mohou stáhnout kopii originálu prohlášení o shodě pro naše produkty RE z našeho serveru:

<http://www.doc.panasonic.de>

Oprávněný zástupce:

Panasonic Marketing Europe GmbH, Panasonic Testing Centre, Winsbergring 15, 22525 Hamburg, Německo

Hrvatski

Deklaracija o podobnosti (DoC)

Ovime, "Panasonic Corporation" izjavljuje da ovaj proizvod udovoljava osnovnim zahtjevima i ostalim relevantnim uvjetima Smjernice 2014/53/EU.

Kupci mogu preuzeti kopiju originalne DoC za naše RE proizvode s našeg DoC poslužitelja:

<http://www.doc.panasonic.de>

Adresa ovlaštenog predstavništva: Panasonic Marketing Europe GmbH,

Panasonic Testing Centre, Winsbergring 15, 22525 Hamburg, Njemačka

Lietuviškai

Atitikties deklaracija (AD)

Bendrovė "Panasonic Corporation" patvirtina, kad šis gaminys tenkina direktyvos 2014/53/ES esminius reikalavimus ir kitas taikytinas nuostatas.

Mūsų RE gaminių originalios atitikties deklaracijos kopiją klientai gali atsisiųsti iš mūsų AD servero:

<http://www.doc.panasonic.de>

Igaliojoto atstovo adresas: "Panasonic Marketing Europe GmbH",
Panasonic Testing Centre, Winsbergring 15, 22525 Hamburg, Vokietija.

Slovensko

Izjava o skladnosti (DoC)

S pričujočo izjavo podjetje "Panasonic Corporation" izjavlja, da so svoji izdelki skladni s poglavitnimi zahtevami in drugimi odgovarjajočimi predpisi direktive 2014/53/EU.

Stranka lahko naloži izvod izvirnega DoC o naših izdelkih RE s strežnika DoC:

<http://www.doc.panasonic.de>

Pooblaščen zastopnik: Panasonic Marketing Europe GmbH,
Panasonic Testing Centre, Winsbergring 15, 22525 Hamburg, Nemčija

Slovensky

Vyhlasenie o zhode (DoC)

"Panasonic Corporation" týmto prehlasuje, že tento výrobok je v zhode so základnými požiadavkami a ďalšími príslušnými ustanoveniami smernice 2014/53/EU.

Zákazníci si môžu stiahnuť kópiu pôvodného DoC na naše RE výrobky z nášho servera DoC:

<http://www.doc.panasonic.de>

Kontakt na splnomocneného zástupcu: Panasonic Marketing Europe GmbH,

Panasonic Testing Centre, Winsbergring 15, 22525 Hamburg, Nemecko

Norsk

Samsvarserklæring (DoC)

"Panasonic Corporation" erklærer at utstyret er i samsvar med de grunnleggende krav og øvrige relevante krav i direktiv 2014/53/EU. Kundene kan laste ned en kopi av den originale samsvarserklæringen (DoC) for vårt RE utstyr fra vår DoC server:

<http://www.doc.panasonic.de>

Kontakt vår autoriserte representant: Panasonic Marketing Europe GmbH,

Panasonic Testing Centre, Winsbergring 15, 22525 Hamburg, Tyskland

Polski

Deklaracja zgodności (DoC)

Niniejszym "Panasonic Corporation" deklaruje, że ten produkt jest zgodny z zasadniczymi wymaganiami oraz innymi właściwymi przepisami Dyrektywy 2014/53/UE.

Klienci mogą pobrać kopię oryginalną Deklaracji zgodności (DoC) naszych produktów RE z naszego serwera DoC:

<http://www.doc.panasonic.de>

Kontakt z autoryzowanym przedstawicielstwem: Panasonic Marketing Europe GmbH,

Panasonic Testing Centre, Winsbergring 15, 22525 Hamburg, Niemcy

Eesti keel

Vastavusdeklaratsioon (DoC)

"Panasonic Corporation" kinnitab käesolevaga, et see toode on vastavuses põhiliste nõuete ja muude direktiivi 2014/53/EL asjakohaste sätetega.

Klientid saavad koopia meie RE toodetele kehtiva originaalvastavusdeklaratsiooni koopia alla laadida meie DoC-serverist:

<http://www.doc.panasonic.de>

Võtte ühendust volitatud esindajaga: Panasonic Marketing Europe GmbH,

Panasonic Testing Centre, Winsbergring 15, 22525 Hamburg, Saksamaa

Latviski

Atbilstības deklarācija (DoC)

Kompānija "Panasonic Corporation" ar šo paziņo, ka šis izstrādājums atbilst būtiskām prasībām un citām saistošām Direktīvas 2014/53/ES prasībām.

Pircēji var lejupielādēt oriģinālo DoC kopiju mūsu RE izstrādājumos no mūsu DoC servera:

<http://www.doc.panasonic.de>

Lūdzam sazināties ar pilnvaroto parstāvi Panasonic Marketing Europe GmbH,

Panasonic Testing Centre, Winsbergring 15, 22525 Hamburg, Vācijā

Български

Декларация за съответствие (DoC)

"Panasonic Corporation" декларира, че този продукт съответства на съществените изисквания и другите приложими разпоредби на Директива 2014/53/ЕС. Потребителите могат да свалят копия от оригиналните DoC към нашите продукти от типа RE от сървъра, на който се съхраняват DoC:

<http://www.doc.panasonic.de>

За контакт с оторизиран представител: Panasonic Marketing Europe GmbH,

Panasonic Testing Centre, Winsbergring 15, 22525 Hamburg, Германия

Român

Declarație de Conformitate (DoC)

Prin prezenta, societatea "Panasonic Corporation" declară că produsul este conform cu cerințele esențiale și cu alte norme corespunzătoare Directivei 2014/53/UE.

Clienții pot descărca o copie a DoC-ului original al produselor noastre RE de la adresa noastră DoC din Internet:

<http://www.doc.panasonic.de>

Contact la Reprezentanța autorizată: Panasonic Marketing Europe GmbH,
Panasonic Testing Centre, Winsbergring 15, 22525 Hamburg, Germania

Magyar

Megfelelőségi Nyilatkozat (DoC)

Ezennel a "Panasonic Corporation" kijelenti, hogy a jelen termék kielégíti a 2014/53/EU irányelv létfontosságú követelményeit és más vonatkozó rendelkezéseit.

A vásárlók letölthetik az RE termékek eredeti DoC másolatát a DoC szerverünkről:

<http://www.doc.panasonic.de>

Forduljon a hivatalos márkaképviselethez: Panasonic Marketing Europe GmbH,

Panasonic Testing Centre, Winsbergring 15, 22525 Hamburg, Németország

Türkçe

Uygunluk Beyanı (DoC)

"Panasonic Corporation" işbu belge ile bu ürünün 2014/53/EU sayılı Direktif'in temel gereklerine ve diğer ilgili hükümlerine uygun olduğunu beyan etmektedir.

Müşterilerimiz RE ürünlerimizle ilgili orijinal DoC belgesinin bir kopyasını DoC sunucumuzdan indirebilir:

<http://www.doc.panasonic.de>

Yetkili Temsilci ile temasa geçin:

Panasonic Marketing Europe GmbH, Panasonic Testing Centre, Winsbergring 15, 22525 Hamburg, Almanya

Limited Warranty (ONLY FOR AUSTRALIA)

Panasonic Warranty

1. The product is warranted for 12 months from the date of purchase. Subject to the conditions of this warranty Panasonic or its Authorised Service Centre will perform necessary service on the product without charge for parts or labour, if in the opinion of Panasonic, the product is found to be faulty within the warranty period.
2. This warranty only applies to Panasonic products purchased in Australia and sold by Panasonic Australia or its Authorised Distributors or Dealers and only where the products are used and serviced within Australia or its territories. Warranty cover only applies to service carried out by a Panasonic Authorised Service Centre and only if valid proof of purchase is presented when warranty service is requested.
3. This warranty only applies if the product has been installed and used in accordance with the manufacturer's recommendations (as noted in the operating instructions) under normal use and reasonable care (in the opinion of Panasonic). The warranty covers normal domestic use only and does not cover damage, malfunction or failure resulting from use of incorrect voltages, incorrect installation, accident, misuse, neglect, build-up of dirt or dust, abuse, maladjustment of customer controls, mains supply problems, thunderstorm activity, infestation by insects or vermin, tampering or repair by unauthorised persons (including unauthorised alterations), introduction of sand, humidity or liquids, commercial use such as hotel, office, restaurant, or other business or rental use of the product, exposure to abnormally corrosive conditions or any foreign object or matter having entered the product.
4. This warranty does not cover the following items unless the fault or defect existed at the time of purchase:
 - (a) Cabinet Part(s)
 - (b) Video or Audio Tapes
 - (c) SD cards or USB devices
 - (d) User replaceable Batteries
etc
 - (e) DVD, Blu-ray or Recordable Discs
 - (f) Video / Audio Heads from wear and tear in normal use
 - (g) Information stored on Hard Disk Drive, USB stick or SD card
 - (h) DTV reception issues caused by TV Aerial / Cabling / Wall socket(s)
5. Some products may be supplied with Ethernet connection hardware. The warranty is limited on such products and will not cover
 - (a) Internet and or DLNA connection / setup related problems
 - (b) Access fees and or charges incurred for internet connection
 - (c) The use of incompatible software or software not specifically stipulated in the product operations manual;
and
 - (d) Any indirect or consequential costs associated with the incorrect use or misuse of the hardware, its connection to the internet or any other device.
6. To claim warranty service, when required, you should:
 - Telephone Panasonic's Customer Care Centre on 132600 or visit our website referred to below and use the Service Centre Locator for the name/address of the nearest Authorised Service Centre.
 - Send or take the product to a Panasonic Authorised Service Centre together with your proof of purchase receipt as a proof of purchase date. Please note that freight and insurance to and / or from your nearest Authorised Service Centre must be arranged by you.
 - Note that home or pick-up/delivery service is available for the following products in the major metropolitan areas of Australia or the normal operating areas of the nearest Authorised Service Centres:
 - Plasma/LCD televisions / displays (screen size greater than 103 cm)
7. The warranties hereby conferred do not extend to, and exclude, any costs associated with the installation, de-installation or re-installation of a product, including costs related to the mounting, de-mounting or remounting of any screen, (and any other ancillary activities), delivery, handling, freighting, transportation or insurance of the product or any part thereof or replacement of and do not extend to, and exclude, any damage or loss occurring by reason of, during, associated with, or related to such installation, de-installation, re-installation or transit.

Panasonic Authorised Service Centres are located in major metropolitan areas and most regional centres of Australia, however, coverage will vary dependant on product. For advice on exact Authorised Service Centre locations for your product, please telephone our Customer Care Centre on 132600 or visit our website and use the Service Centre Locator.

In addition to your rights under this warranty, Panasonic products come with consumer guarantees that cannot be excluded under the Australian Consumer Law. If there is a major failure with the product, you can reject the product and elect to have a refund or to have the product replaced or if you wish you may elect to keep the goods and be compensated for the drop in value of the goods. You are also entitled to have the product repaired or replaced if the product fails to be of acceptable quality and the failure does not amount to a major failure.

If there is a major failure in regard to the product which cannot be remedied then you must notify us within a reasonable period by contacting the Panasonic Customer Care Centre. If the failure in the product is not a major failure then Panasonic may choose to repair or replace the product and will do so in a reasonable period of time from receiving notice from you.

**THIS WARRANTY CARD AND THE PURCHASE DOCKET (OR SIMILAR PROOF OF PURCHASE)
SHOULD BE RETAINED BY THE CUSTOMER AT ALL TIMES**

If you require assistance regarding warranty conditions or any other enquiries, please visit the **Panasonic Australia** website **www.panasonic.com.au** or contact by phone on **132 600**
If phoning in, please ensure you have your operating instructions available.

Panasonic Australia Pty. Limited

ACN 001 592 187 ABN 83 001 592 187

1 Innovation Road, Macquarie Park NSW 2113

PRO-031-F11 Issue: 4.0

01-01-2011

For the United Kingdom and Ireland customers

Sales and Support Information

Customer Communications Centre

- For customers within the UK: 0344 844 3899
- For customers within Ireland: 01 289 8333
- Monday–Friday 9:00 am – 5:00 pm (Excluding public holidays).
- For further support on your product, please visit our website:
www.panasonic.co.uk

Direct Sales at Panasonic UK

- Order accessory and consumable items for your product with ease and confidence by phoning our Customer Communications Centre Monday–Friday 9:00 am – 5:00 pm (Excluding public holidays).
- Or go on line through our Internet Accessory ordering application at www.pas-europe.com.
- Most major credit and debit cards accepted.
- All enquiries transactions and distribution facilities are provided directly by Panasonic UK.
- It couldn't be simpler!
- Also available through our Internet is direct shopping for a wide range of finished products. Take a browse on our website for further details.



Manufactured by: Panasonic Corporation
Kadoma, Osaka, Japan
Importer for Europe: Panasonic Marketing Europe GmbH
Panasonic Testing Centre
Winsbergring 15, 22525 Hamburg, Germany



Panasonic Corporation
Web Site: <http://www.panasonic.com>



72-H488EG-120B4

En