

Operating Instructions

Household Use Electronic Rice Cooker

Model No. 1.0 L SR-DL104
1.8 L SR-DL184



The pictures in these instructions use SR-DL104 as an example.

Thank you for purchasing this Panasonic product.

- This appliance is intended to be used in household and similar applications.
- Please read these Operating Instructions carefully for safe and proper use of this product.
- **Be sure to read the "Safety Precautions" (page 2 ~ 3) before use.**
- Make sure that information such as date of purchase and dealer's name are stated on the warranty card.

Keep for future use



Contents

Safety Precautions	2-3	Before Use
Instructions for Use	4	
Parts Identification		
● Main body	5	Usage
● Control panel	5	
Preparation		
● Wash rice and add water	6	Usage
● Function selecting/Setting cooking time/ Tips to cook delicious rice	7	
Menu Functions		
● Cooking rice or grains/Keep warm/Reheat	8	Usage
● Porridge and other cuisines/Timer	9	
Cleaning and Maintenance	10	
Recipes	11	Troubleshooting
Troubleshooting	12-13	
Error Codes Indication	14	
Specifications	15	
Notes	16-17	
Warranty	Back cover	Troubleshooting

Safety Precautions

Be sure to observe the following precautions

To prevent personal injury, injury to others and property damage, the following instructions must be followed.

■ The following symbols show the damage or harm level caused by incorrect operation.

 **WARNING:** Indicates a potential hazard which could result in death or serious injury.

 **CAUTION:** Indicates a potential hazard which could result in injury or damage to property.



■ Classification and description of symbols are as follows.

 This symbol indicates an action that is prohibited.

 This symbol indicates an action that must be followed.

WARNING



■ Power supply · Power cord · Power plug

-  ● **Do not use the appliance if the power cord or power plug is damaged or the power plug is loosely connected to the power outlet.**
(To avoid causing an electric shock, or a fire due to a short circuit.)
→ If the power cord is damaged, it must be replaced by a special cord or assembly available from the manufacturer or its service agent.
- **Do not damage the power cord or power plug.**
· The following actions are strictly prohibited:
Damaging, processing, making contact with or near high temperature surfaces or heating elements, forcibly bending, twisting, pulling, hanging/pulling over sharp corners, placing heavy objects on it, tying into bundles, sandwiching, pulling the power cord to move. (So as to avoid electric shock due to damaged power cord and power plug or avoid fire due to short circuit.)
- **Do not connect or disconnect the power plug with wet hands.**
· Make sure your hands are dry before touching the power plug or the product.
(To avoid causing an electric shock or injury.)
- **Do not spill water or other liquids on the instrument plug.**
(To avoid causing an electric shock, or fire due to a short circuit.)
-  ● **Be sure to use a separate AC power outlet with the rated values as listed in the specification table (P15).**
(Using the unit together with other equipment on the same outlet can cause overheating and fire.)
· Only use a power strip rated at least 10 amperes.
- **Make sure that the power plug and the instrument plug are fully inserted in place.**
(To avoid causing smoke, fire or electric shock.)
- **Single-phase bipolar grounded power outlets should be used for this appliance to ensure reliable grounding. If a grounding device is not installed, electrostatic induction of other metal parts such as housing may occur.**
(To avoid causing the risk of electric shock due to failure or electric leakage.)

● Clean the power plug regularly.

(To avoid causing a fire due to poor insulation of the power plug due to accumulation of moisture and foreign matter.)
→ Disconnect the power plug and wipe it with a dry cloth.

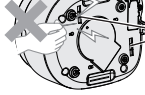
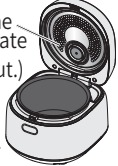
■ Main body

- **Do not insert anything into the vent or gaps, especially pins or other metal objects.**
(To avoid causing an electric shock or abnormal operation.)
 Vent
- **Do not place items which may clog the hole on the heating plate into the pan.**
(So as to avoid burns or injuries resulting from steam or cooked food blowing out.)
Cooking methods which involve ingredients and seasonings that are placed into a plastic bag to heat cannot be done with this appliance.
 Hole on the heating plate
- **Do not modify, disassemble, or repair this appliance.**
(To avoid causing a fire, electric shock or injury.)
→ For repair, please contact a Panasonic authorized service center.
- **Do not use this appliance for any purpose other than those described in the Operating Instructions.**
(To avoid causing a fire, burn, injury or electric shock.)
· Panasonic shall not assume any responsibility for improper use or failure to follow the operating instructions.
- **Do not immerse the appliance in water or splash it with water.**
(To avoid causing an electric shock, or a fire due to a short circuit.)
→ Please contact a Panasonic authorized service center if water gets inside the appliance.

! WARNING

■ Use



- **When in use or after cooking, do not put your face or hands near the steam vent. Special attention must be paid to children and infants.**
(To avoid causing a burn.)



- **Do not open the lid or move the main body during cooking.**
(So as to avoid burns or injuries resulting from steam or cooked food blowing out.)



- **This appliance is not intended for use by persons (including children) with reduced physical, sensory or mental capabilities, or lack of experience and knowledge, unless they have been given supervision or instruction concerning use of the appliance by a person responsible for their safety. Children should be supervised to ensure that they do not play with the appliance.**
(To avoid causing burns, injury or electric shock.)

- **Keep the appliance out of reach of small children.**
(To avoid causing burns, injury or electric shock.)

- **If an abnormality or malfunction occurs, stop using the appliance immediately and unplug the power plug.**
(To avoid causing smoke, fire or electric shock.)

Abnormalities · Malfunction Cases:

- The power plug and cord become abnormally hot.
 - The power cord is damaged or there are intermittent power outages when being touched.
 - The main body is deformed or abnormally hot.
 - The main body emits smoke or a burning smell.
 - The main body is broken, loose or makes abnormal noise.
 - The heating plate is warped or the pan is deformed.
- Please contact a Panasonic authorized service center for inspection and repair immediately.

! CAUTION



- **Do not use a non-dedicated pan or a deformed pan.**
(To avoid causing burns or injury due to overheating or malfunction.)

- **Do not use the appliance in the following places:**

- Near heat or in high humidity environments.
(To avoid causing electric shock, electric leakage or fire.)
- On uneven surfaces or a mat which is not heat-resistant.
(To avoid causing injury, burns or fire.)
- In places close to walls or furniture, etc.
(To avoid bumping into them when opening the outer lid, or causing discoloration, deformation and breakage of the furniture.)



- **Do not move the main body while in use.**
(So as to avoid burns caused by the opening of the outer lid due to touching the hook button.)

- **Do not touch the hot surfaces while the appliance is in use or after cooking.**

- The main body has a high temperature.
In particular, the metal parts such as the heating plate, the pan and cast heater.

(To avoid causing a burn.)



- **Do not expose the power plug to the steam.**

- (To avoid causing an electric shock, or fire due to a short circuit.)

→ When using a cabinet with sliding table, use the appliance where the power plug cannot be exposed to steam.



- **Do not let the appliance operate in an empty state.**
(To avoid causing burns.)

- **Do not connect the appliance to an external timing device or operate the appliance using a separate remote control system.**
(To avoid fire.)

- **When you unplug the power plug, be sure to hold the plug itself, and never pull the power cord.**
(To avoid causing an electric shock, or a fire due to a short circuit.)

- **When taking out the pan or when the pan is not in use, remember to turn off the power and unplug the power plug.**
(To avoid causing burns, injury, or an electric shock, leakage, fire due to insulation aging.)

- **Wait for the main body to cool down sufficiently before cleaning.**
(To avoid causing burns.)

- **When used within a cupboard or other enclosed spaces, make sure that the steam can emit outward.**
(To avoid causing discoloration or deformation of the cupboard.)

- **This appliance is intended to be used in household and similar applications such as:**

- staff kitchen areas in shops, offices and other working environments;
- farm houses;
- by clients in hotels, motels and other residential type environments;
- bed and breakfast type environments.

If a power outage occurs during use

This includes unplugging of the power plug, trip, etc.

- Return to standby mode.

Instructions for Use

About the Main Body

- If the product is on a cabinet with sliding table, make sure that the load capacity of the table is greater than

1.0 L: 10 kg
1.8 L: 12 kg

(To avoid dropping the product.)



- Do not cover the outer lid with a cloth or other objects when the product is in use.

(To avoid causing the steam from being blocked, resulting in deformation, discoloration of the outer lid and malfunction of the product.)



- Do not tilt or rotate the product.

- Please clean rice and other foreign objects that become stuck on the main body (bottom sensor, cast heater, and the bottom of the pan). In order to avoid error displays, scorched rice, half-cooked rice, etc.

Edge or bottom



(Pan)

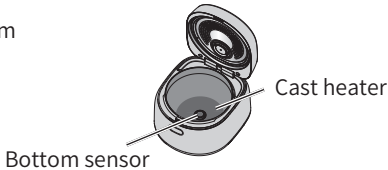

Bottom sensor

Cast heater

- Be sure to remove the pan protection bag before use. (So as to avoid poor cooking or fire.)

- Do not pour food that needs to be cooked directly into the protective frame where no pan has been placed. (So as to avoid failure caused by impurities.)

- When there is any overflow of rice water from the steam vent, pull out the power plug immediately to disconnect the power supply. Do not resume use until the rice water on the power plug and the instrument plug is cleaned with a dry cloth.

- Do not use the product outdoors. (Unstable power supply may result in product failure.)

- Avoid using the product under direct sunlight. (So as to avoid color change/discoloration.)

- Do not use this product on items that are not resistant to high temperatures, such as carpets, electric heating carpets, and tablecloths (made of ethylene plastic). (So as to avoid poor cooking or fire.)

About the Pan

- Do not use the pan in places other than the rice cooker.



- Do not use it on a gas stove or induction cooker or in a microwave.

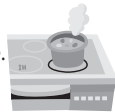

- Avoid hitting the pan against hard objects.



Doing so may cause scratches or dents on the outer surface.



- Pay attention to the following in order to avoid damaging the coating of the pan.

Before cooking



- Do not let objects like metal sieves make contact with the coating of the pan.



After cooking



- Do not put vinegar into the rice in the pan. (While cooking Sushi and other food)
- Do not use a metal spoon. (While cooking congee and other food)
- Do not touch or strike the pan. (While filling a bowl with rice)

During cleaning and maintenance(P10)



- Do not use the pan as a washing container.
- Do not place spoons or other utensils into the pan.
- After cooking with seasoning, do not leave food inside the pan. →Please clean out the food in the pan as soon as possible and then clean the pan.
- Do not use a bowl dryer or dish washer/dryer for cleaning.
- Do not put the pan onto other utensils to dry after washing.
- Do not use abrasive materials such as powders, metal brushes, nylon brushes or scouring pads to clean or scrub the pan. →To clean the pan, wash it with a soft sponge.



Notes

The following will not affect product performance or personal health.

[Outer surface] superficial scratches, small dents or collisions.

[Inner surface] flaking of the coating of the pan.

→If the pan is deformed or if you are worried about its condition, please purchase a new pan.

Parts Identification

Before using this product for the first time, clean the pan, moisturizing cap, and accessories. (P10)
The control panel is covered with protective film. Please remove it before use.

Main body



Control panel

Pan seal ring

Heating plate

Outer lid

Moisturizing cap

Pan

Cast heater

Bottom sensor

Power plug

Hook button

Body

Power cord

instrument plug

Accessories



Rice scoop(1)



Porridge [Soup] scoop(1)



Measuring cup(1)
(Approx.180 mL)



Steaming basket(1)

Before Use

Control panel

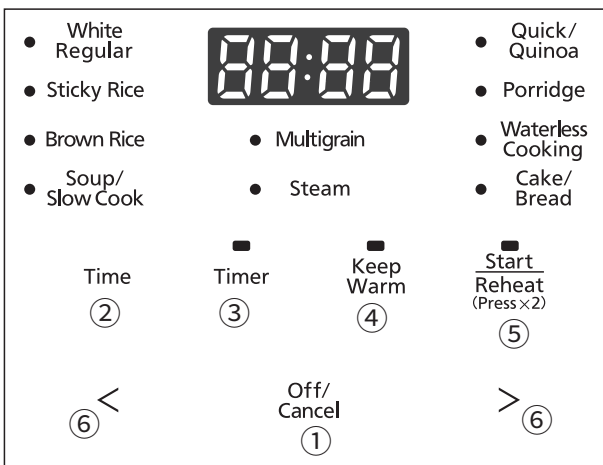

- 「Off/Cancel」 :
 - Cancel incorrect operation, or turn off keep warm.
- 「Time」:
 - To set the cooking time, you must first press this key.
- 「Timer」:
 - Press this key to use the timer..
- 「Keep Warm」:
 - Press this key to keep food warm.
- 「Start」:
 - Press this key to start cooking or end the setting of the preset time.
- 「<」or「>」:
 - It is used to select the function.
 - It is used to set preset time and cooking time.
 - When setting time, press and hold the key to quickly add or subtract time.

Notes

When the product is in use, it is normal for the [Off/Cancel] key to take longer to respond. If there is no operation for 30 seconds, the product will enter sleep mode. To exit sleep mode, press any key. Keys may take longer to respond when exiting sleep mode.

Preparation

Wash rice and add water

Before using for the first time

Boil a pan of water, then drained it.

- ① Add water to the waterline 4 of "White Rice", and close the outer lid.
- ② Select the "Steam" function, and set the cooking time to 15 minutes.
- ③ When you hear the buzzer, remove the pan, and pour away the water inside it.

1

Measure rice with the measuring cup provided

- Check the maximum quantity of rice that can be cooked at once
 "Specifications" on P15.

○ Correct



About 180 mL
(about 150 g)

× Incorrect

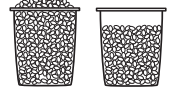

2

Wash the rice until the water turns relatively clear

- ① Wash the rice quickly with plenty of water, changing the water as you go.
 - ② Stir the rice gently, and repeat washing several times → rinse with water until the water turns relatively clear.
- In order to avoid scratching the non-stick coating on the pan surface, do not wash rice in the pan.
 - Wash the rice thoroughly. Otherwise, rice crust may appear and the residual rice bran may affect the taste of the rice.

①

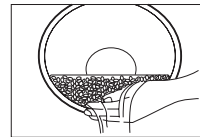

②



3

Place the washed rice into the pan

Add water up to the corresponding waterline ( P7) and dry the outside of the pan.

- When adding water, place the pan on a flat surface and flatten the surface of the rice. (Confirm that the right amount of water is added based on the correct scale.)
- When too much water is added, it may overflow when cooking.
- Quinoa can only be cooked one cup at a time, and requires 1.5 cups of water (Approx 270 mL).

Example: when cooking 3 cups of rice, add water to the "3" waterline of "White Rice".

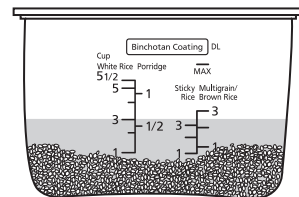

4

Put the pan into the body and close the outer lid

- So that the pan bottom can be closely attached to the cast heater, please rotate the pan along the direction indicated by the arrow for 2 or 3 times.
- Check if the moisturizing cap is correctly positioned. (Cleaning and maintenance  P10)
- When closing the outer lid, confirm that there is a "click" sound.

①



②

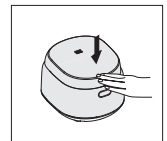

5

Connect the plugs

- Plug in the instrument plug, then the power plug, and make sure both are connected securely.

①

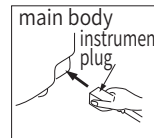

②

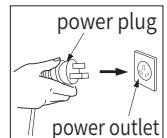

Please Note

When cooking with the steaming basket, the maximum cooking capacity is: 1.0 L Model: 3 cups; 1.8 L Model: 6 cups.

Preparation Function selecting/Setting cooking time/Tips to cook delicious rice

■ Function selecting

Table 1

Categories of food to cook	Menu select	Waterline	¹ Cooking time (Approx. minutes)	² Keep warm (auto)	³ Preset timer options
White Rice	White Regular	White Rice	43	✓	60 minutes or more
	Quick/Quinoa		30	✓	60 minutes or more
Quinoa		*4		✗	
Sticky Rice	Sticky Rice	Sticky Rice	37	✗	60 minutes or more
Brown Rice	Brown Rice	Brown Rice	110	✗	2 hours 10 minutes or more
Multigrain	Multigrain	Multigrain/Brown Rice	70	✗	1 hour 20 minutes or more
Porridge	Porridge	Porridge	Table 2	✗	Cooking time + 10 minutes or more
Soup/Slow Cook	Soup/Slow Cook	To the maximum waterline of "Porridge"	Table 2	✗	—
Steam	Steam	Add water to 4 cups when steaming	Table 2	✗	Cooking time + 20 minutes or more
Waterless Cooking	Waterless Cooking	1.0 L:MAX 1.8 L:To the maximum waterline of "Porridge"	Table 2	✗	—
Cake/Bread	Cake/Bread	—	Table 2	✗	—

*1 · These cooking times are based off a room temperature of 20°C and a water temperature of 20°C, and with a medium amount of rice (3 cups for the 1.0 L model, or 5 cups for the 1.8 L model) and at the rated voltage as listed in the specification table.

· The actual cooking time will vary according to the amount of rice, water, voltage, temperature, water temperature and rice quality.

*2 · At the end of cooking, the unit will automatically change to 'Keep Warm'. It is not recommended that foods marked with "x" are kept warm with this function. Please press the [Off/Cancel] key as soon as possible after cooking has ended.

*3 · The Soup/Slow cook, Waterless Cooking, Cake/Bread and Reheat functions do not have a timer option.

· In summer when temperatures are higher, the preset timer for rice menus should not be greater than 8 hours to avoid rice deterioration.

*4 · Quinoa can only be cooked one cup at a time, and requires 1.5 cups of water (Approx 270 mL).

■ Setting cooking time

Table 2

Categories of food to cook	Menu select	Setting cooking time range	Setting increments	Initial value	Time display	Time memory*
Porridge	Porridge	1 hour-4 hours	10 minutes	1 hour	Back to 1 hour after 4 hours	○
Soup/Slow cook	Soup/Slow cook	1 hour-12 hours	30 minutes	1 hour	Back to 1 hour after 12 hours	○
Steam	Steam	1 minute-60 minutes	1 minute	5 minutes	Back to 1 minute after 60 minutes	○
Waterless Cooking	Waterless Cooking	10 minutes-2 hours	10 minutes	30 minutes	Back to 10 minutes after 2 hours	○
Cake/Bread	Cake/Bread	40 minutes-60 minutes	1 minute	60 minutes	Back to 40 minutes after 60 minutes	○

*: After the power is off, the cooking time is reset and the previously set cooking time is no longer memorized.

★ Tips to cook delicious rice

① ● Measure water and rice correctly.



② ● Wash rice gently and quickly.
● Do not place rice in a sieve.
(To avoid rice fragmentation or rice sticking to the pan.)



③ ● Add water to the pan on a flat countertop.
● Do not use hot water or alkaline water with a pH higher than 9.
(So as to avoid rice from sticking to the pan or becoming burned.)



Menu Functions Cooking rice or grains/Keep warm/Reheat

※When cooking rice or quinoa

1 Press < or > key to select desired function.

- The selected function menu flashes.
- The "Start" indicator lights up.

2 Press  to start cooking.

- The "Start" indicator lights up.
- The remaining time decreases in units of 1 minute. When using the "Quick/Quinoa" and "Brown Rice" function, the remaining time will be displayed approximately 7 minutes and 12 minutes before cooking ends.
- After entering the cooking stage, the remaining cooking time displayed will be automatically adjusted depending on the rice volume. For example, it may sometimes drop from "15" to "13", rather than decreasing in units of 1 minute.

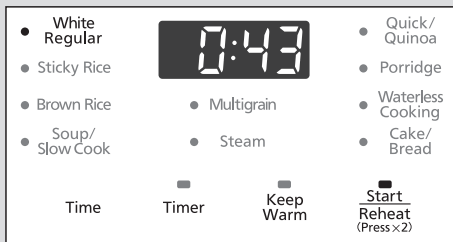

3 When cooking is over, loosen the rice or quinoa.

- After the buzzer rings, cooking has finished. The function will automatically change to keep warm status. To prevent the rice or quinoa from sticking together, please loosen after cooking.
- For Quinoa, Sticky Rice, Brown Rice or Multigrain, when cooking is over, press the Off/Cancel key as soon as possible to cancel "keep Warm" and avoid affecting the taste.

■ Please note

- When cooking with "Quick/Quinoa", as the cooking time is shortened, the rice may be harder or there may be rice crust. →Soak the rice in water in advance, and you can make the cooked rice become soft.
- Do not mix brown rice with white rice, as this may affect the cooking result.

Keep Warm

- Keep warm time displays from 0:00 to 23:59. After 24 hours, it displays "- - - -", but it is still keeps warm.
- If the "Keep Warm" function is used for longer than 96 hours, it will automatically stop, and the display will show "U14." To continue use, press the [Off/Cancel] button first.
- Cooked rice should be consumed within 12 hours of keeping warm to avoid discoloration or becoming stale.
- When using the keep warm function, there may be some droplets at the edge of the pan.
- The rice taste may be affected if the rice scoop is left in the pan when using the keep warm function..

※When reheating cooled rice

Preparation

- Stir the cooled rice in the pan to make it even.
- Please refer to the following table for the amount of water to be added.

Table 3

Cooled rice quantity (Waterline)	Water volume (measuring cup)	
	1.0 L	1.8 L
1	1/4	1/4
2	1/2	1/2
3	1/2	1/2
4	—	1/2
5	—	1

- The maximum amount of cooled rice that can be reheated is:
1.0 L: White Rice 3 cups 1.8 L: White Rice 5 cups

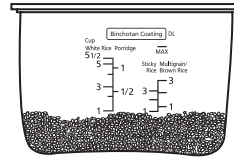

1 Press < or > to select a rice cooking function, like "White Regular".

2 Press  twice to start reheating.

- No matter how much cooled rice to reheat, the heating time is about 15 minutes.

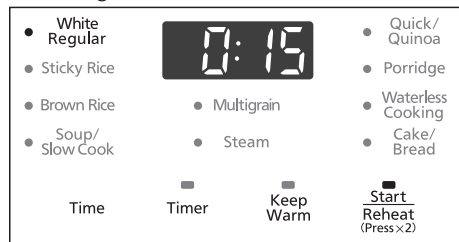

3 After the buzzer rings, reheating has finished. The function will automatically change to keep warm status.

- Please loosen the rice as soon as possible, as it will be more delicious.

■ Please note

- When adding cooled rice, do not exceed the maximum amount (as shown in Table 3).
- It is recommended to reheat cooled rice only once to avoid affecting the taste of the rice.
- Do not reheat sticky rice, brown rice, quinoa or multigrain rice to avoid affecting the taste.

Menu Functions Porridge and other cuisines/Timer

※When cooking porridge for 1.5 hours

1 Press < or > key to select "Porridge".

- The selected function menu flashes.
- The [Start] indicator lights up.

2 Press  and then press < or > key to set the cooking time.

- Press and hold the [<] or [>] key to quickly add or subtract time.

※For details about what cooking time can be set,  P7 Table 2.

3 Press  to start cooking.

- The "Start" indicator lights up.
- The remaining time decreases in unit of 1 minute.

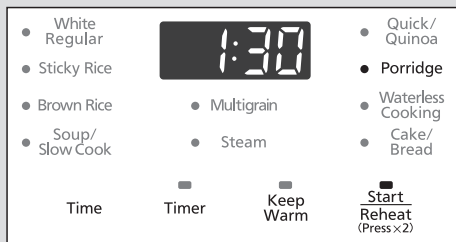

4 After the buzzer rings, cooking has finished. The function will automatically change to keep warm status.

- Keep warm function will affect taste, press 「Off/Cancel」 key as soon as possible.

■ Please note

- Opening the lid during cooking will increase the amount of condensation.
- Incorrect water quantity or rice quantity may lead to overflow of rice water from the steam vent.
- When the porridge is kept in keep warm function for an excessively long time, it will get thicker.
- Soup may overflow if exceeding the "Porridge" max water level. ( "Specifications" on P15)
- For longer steaming time, add 4 cups of water to avoid dry heating.
- When using the steam function, the time shown on the display is the remaining time after the water in the pan boils.
- The maximum weight of cake batter/bread batter must not exceed: 1.0 L: 500 g, 1.8 L: 700 g (total weight of cake mix/bread flour, milk, eggs, etc.). Otherwise the cake/bread may be under-baked.
- When baking the cake batter with maximum weight, set the cooking time to 60 minutes to avoid the cake/bread being half-cooked.
- For "Waterless cooking" function, it is recommended to use ingredients with high moisture content (e.g. mushrooms, cabbage, etc.) or put ingredients that are prone to becoming juicy at the bottom for cooking.

※Using the "Timer" function

For the following example, the "White Regular" function will be completed after 4 hours.

1 Press < or > key to select "White Regular".

- The selected function menu flashes.
- The [Start] indicator lights up.
- When porridge or steam timer is set, you need to set the cooking time accordingly, and then press the Timer key.

2 Press .

3 Press < or > key to set the preset time.

- Press and hold the [<] or [>] key to quickly add or subtract time.
- For the functions and time range which apply to the timer  P7 Table 1.

4 Press , Timer cooking starts.

- The "Start" indicator turns off, the "Timer" indicator lights up, then the preset is finished.

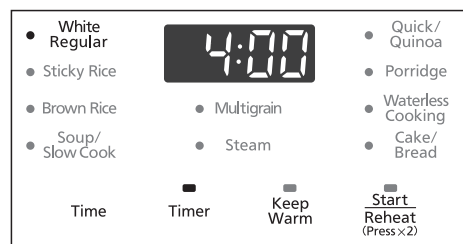

■ Please note

- In summer when temperature is high, the preset time for rice menus should not be greater than 8 hours to avoid rice deterioration.
- In summer when temperature is high, it is not recommended to use the "Timer" function with the "Steam" function.

Cleaning and Maintenance

Attention

- Before cleaning, pull out the power plug first. Do not clean the main body until it cools down.
- When cleaning the main body, do not immerse it in water, or clean it with lacquer thinner, gasoline, alcohol, cleaning powder or abrasive materials, etc.
- Do not use a dishwasher or dish dryer.

Heating plate/Pan seal ring

Wipe with a damp cloth.

- Clean it promptly after cooking with seasonings. (Failure to do so may result in odor, deterioration or rusting.)
- Do not pull the pan seal ring.
- If oil stains are not removed, any oil stains on the heating plate may stick to it and become difficult to remove. Clean the heating plate after each use.
- As the metal parts are heated, there may be color changes or stripes on their surfaces, which will not affect their normal functions.

Moisturizing cap

- After each use, remove the moisturizing cap, then rinse it so that no odor is produced.

How to remove

Pull it out from the heating plate.

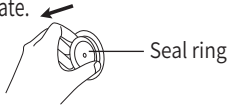

How to Install

Insert it into the hole of the heating plate in the opposite direction of removal.

Be sure to install it to the bottom to prevent it from falling off.

Notes

- Before installation, make sure that the seal ring is attached to the moisturizing cap.

Bottom sensor/Cast heater

Wipe with a damp cloth.

- When adhesion is present, wipe with fine sandpaper (around No.600) or a dry cloth.

Notes

- If you do not clean the bottom sensor, the rice may get burnt or boiled badly.

Pan

- Clean with diluted detergent, a soft sponge and water. Wipe off any water on the outside of the pan.
- Do not use the pan as a container for cleaning.
- Color change or stripes may appear on the fluoridized coating surface, which will not affect human health or normal functions of the main body.

Upper Frame

Wipe with a damp towel.

Notes

- Do not pour water in to wash.

Accessories

Clean with diluted detergent, soft sponge and water.



Rice scoop(1)



Porridge [Soup] scoop(1)



Measuring cup(1)



Steaming basket(1)

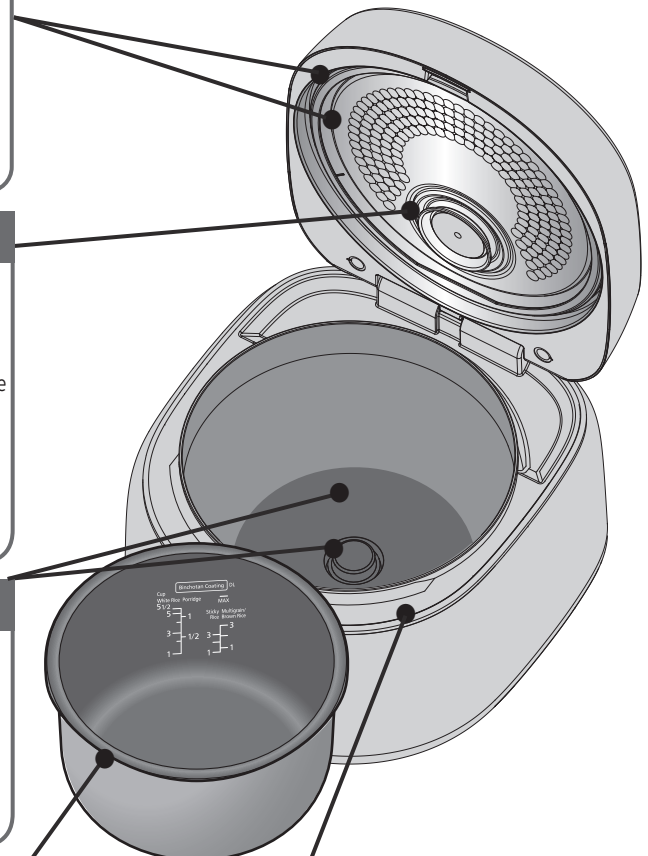

Recipes

Notes: · The rice may get burnt at the bottom depending on the ingredients added.
· To use white fungus soup or other ingredients that will get thicker, use the "Porridge" function and do not exceed the "Porridge" max water level. Otherwise, the soup may overflow.
※ These recipes take the cooking volume of the 1.0 L model as example. Please refer to  P15 for details about the cooking amount of the 1.8 L model.
※ 1 cup (Measuring cup): approx. 150 g

Steamed chicken slices

Ingredients: Skinless chicken thigh 2 (Approx. 150 g) Seasonings: Chili oil 40 mL Light soy sauce 10 mL
Chopped scallion 2 g Vinegar 15 mL Sugar 2.5 g
Chopped ginger 10 g
Chopped garlic 10 g

- Steps: 1) Put the chicken thighs and chopped ginger in the pan, then put the pan into the main body, and close the outer lid.
2) Press the [<] or [>] key to select "Waterless", set the cooking time to 20 minutes, and then press the [Start] key.
3) Mix the chili oil, vinegar, white sugar and light soy sauce in a bowl, then add the chopped scallion and chopped garlic, and mix them well.
4) After the cooking is complete, press the [Off/Cancel] key, open the outer lid, take out the chicken thighs. Discard the original soup; otherwise, it will dilute the original flavor. Then let them cool slightly, cut them into pieces, and drizzle with the juice.

Tomato chicken wings

Ingredients: Chicken wings 8 Seasonings: Tomato ketchup 10 mL Water 50 mL
Shiitake mushrooms 100 g Soy sauce 15 mL Sugar 5 g
Tomato 2 Oyster sauce 10 mL Salt 2.5 g

- Steps: 1) Score both sides of the wings twice with a knife, peel and dice the tomatoes, wash the shiitake mushrooms
2) Put all ingredients and seasoning in the pan then close the outer lid.
3) Press the [<] or [>] key to select "Steam", set the cooking time to 25 minutes, and then press the [Start] key.

Mushroom soup

Ingredients: White beech mushroom 70 g Seasonings: Salt Suitable amount
Crab mushroom 70 g Ground white pepper Small amount
King oyster mushroom 60 g
Chopped scallion Small amount

- Steps: 1) Soak the three species of mushrooms in lightly salted water for 10 minutes. Wash them clean, cut off the roots, and cut the king oyster mushrooms into small pieces.
2) Put all the mushrooms in the pan, add water to the "Porridge" max water level, and close the outer lid.
3) Press the [<] or [>] key to select "Soup/Slow cook", set the cooking time to 1 hour and 30 minutes, and then press the [Start] key.
4) After the cooking is complete, open the outer lid, add a suitable amount of salt, ground white pepper and chopped scallion to taste.

Note: You can choose your favorite species of mushrooms.



Cake (Low-gluten flour)

Ingredients: Low-gluten flour 100 g Butter 30 g
Egg 3 Milk 25 g
White sugar 100 g

- Steps: 1) Separate the egg whites and yolks into two bowls (without water or oil), add 20 g of white sugar to the yolks and stir until smooth and particle-free.
2) Add 80 g of white sugar to the egg whites, beat them with a whisk until the chopsticks can stand upright in the egg whites, add the egg yolks to the egg whites, and stir well left and right.
3) Add the sifted low-gluten flour to the cake batter in batches and stir well until smooth and particle-free.
4) Add melted butter and milk to the cake batter and stir well. Pour the cake batter into the pan and close the outer lid.
5) Press the [<] or [>] key to select "Cake/Bread", and set the cooking time to 50 minutes. Then, press the [Start] key.
6) When the buzzer sounds, it means that the cake is baked. Press the [Off/Cancel] key, take out the pan and let it cool for 2 minutes. Then reverse the pan to pour the cake onto a plate or disk and let it cool.
※ Do not exceed the specified weight of cake batter. Otherwise, the cake may be undercooked.

Troubleshooting

Please check before requesting a repair.

Scenario	Possible Cause
Does not cook during preset time	<ul style="list-style-type: none"> ▶ Check if the [Start] key has been pressed. ( P9)
Cooking time is long or short	<ul style="list-style-type: none"> · If cooking is done continuously, the cooking time will be longer (by up to 30 minutes). ▶ · Due to the different amounts of rice and water, the remaining time displayed may be stopped for adjustment in the middle of cooking. · Is "U12" displayed? ( P14)
The appliance makes a noise	<ul style="list-style-type: none"> · The sound of "click,click" in cooking is the sound of adjusting firepower,which is not a fault. ▶ · The "pa" sound in cooking is the cracking sound generated by the thermal expansion of water droplets at the bottom (outside) of the pan,which is not a fault.
Steam vapor leaks from a place other than the steam vent	<ul style="list-style-type: none"> ▶ · A foreign object may be attached to the pan seal ring or along the pan. · The pan may be deformed.
Key operation can not be performed	<ul style="list-style-type: none"> · Check if the lights above the keys are on. ▶ →Key operation can not be performed during cooking, while using the timer, or when using the "Keep Warm" function. Press the [Off/Cancel] key before operation.
There is a plastic smell	<ul style="list-style-type: none"> ▶ · There may be a plastic smell at the beginning of use. This will be eliminated after several more uses. It is not abnormal.
Rice is glutinous (soft)	<ul style="list-style-type: none"> · Rice quantity and water volume may be incorrect. · There may be broken rice mixed in. · Hot water was used to wash the rice. ▶ · The rice was not loosened immediately after cooking. · Too much water was added into new rice for cooking. · The rice may have been immersed in water for a long time (e.g. preset time is too long, etc.). →When using the timer function to cook, you need to put less water.
Rice is dry (hard) Rice is half-cooked (undercooked)	<ul style="list-style-type: none"> · Rice quantity and water volume may be incorrect. · The outer lid was not closed properly. · The "Quick/Quinoa" function was used for cooking. ▶ · The rice was not loosened immediately after cooking. · The bottom of the pan is uneven. · There is a foreign object attached to the outside of the pan, on the bottom sensor, or on the cast heater. · The wrong function was selected.
Liquid overflows	<ul style="list-style-type: none"> · Rice quantity and water volume may be incorrect. · Rice was not washed prior to cooking. ▶ · The moisturizing cap was not installed correctly. · The outer lid is not was not closed properly. · The wrong function was selected.



Troubleshooting

Please check before requesting a repair.

Scenario	Possible Cause
Rice is scorched	<ul style="list-style-type: none"> · Rice was not washed adequately. · Broken rice has been mixed in. · The bottom of the pan is uneven. ▶ · A foreign object is attached to the bottom of the pan, on the bottom sensor, or on the cast heater. · The cooking timer hasn't been set. · Spices have been added for cooking. · The outer lid was not closed properly.
There is condensation There is odor Rice is yellow	<ul style="list-style-type: none"> · Rice was not washed adequately · Rice has not been loosened immediately after cooking. · The "Keep Warm" function has been used for longer than 12 hours. ▶ · The rice scoop has been left in the pan while using the "Keep Warm" function. · Cooled rice has been added into the pan and the "Keep Warm" function has been used. · Different types of rice or water quality may cause cooked rice to be yellowish in colour. · If seasonings are used during cooking, you may notice a smell. → Carefully clean the pan, heating plate and moisturizing cap after use.
Rice is dry	<ul style="list-style-type: none"> · The "Keep Warm" function is used for longer than 12 hours. ▶ · Rice is reheated several times. · The outer lid was not closed properly.
Rice porridge	<ul style="list-style-type: none"> · The rice was soaked in water for a long time while using the cooking timer function. ▶ · The "Keep Warm" function has been used. · There is too much broken rice.
Rice sticks onto the pan	<ul style="list-style-type: none"> ▶ · Due to the different varieties of rice, soft rice might easily stick to the pan.
A thin film is formed	<ul style="list-style-type: none"> ▶ · A paper-like film is the result of dry starch dissolution, and it is harmless. · If rice is not washed sufficiently prior to cooking, such a film may form.
Timer is not working when using steam function	<ul style="list-style-type: none"> ▶ · There is not enough water in the pan. Add more water, to the pan about half way is best.

Error Codes Indication

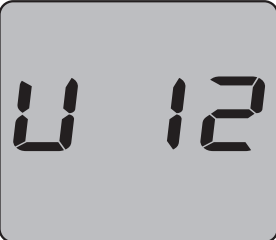
Please check before requesting a repair.

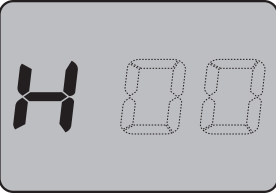
Error display	Please check	Ref. page
	<ul style="list-style-type: none"> ● Is any foreign object attached to the bottom of the pan, the bottom sensor or cast heater? →Press the [Off/Cancel] key, unplug the power cord, and remove foreign objects and stains after the pan has cooled down completely. ● Has too much water been added? →Press the [Off/Cancel] key. (For continuous cooking, you can slightly reduce the amount of water) 	<p style="text-align: center;">4</p> <p style="text-align: center;">6</p>
	<ul style="list-style-type: none"> ● Was the "Keep Warm" duration set to more than 96 hours? →Please press [Off/Cancel] key. 	<p style="text-align: center;">8</p>
<p>If the appliance is still not back to normal after the above is confirmed, contact a Panasonic authorized service center for repair.</p>		
	<ul style="list-style-type: none"> ● Unplug the power plug and plug it in again. If "H※※" still appears, then there is a fault. →Please consult a Panasonic authorized service center, and advise what the error code says (two digits after "H"). 	<p style="text-align: center;">—</p>

Specifications

Model No.		SR-DL104	SR-DL184
Rated voltage		230 V-240 V ~	
Rated frequency		50 Hz	
Rated power input		810 W	
Cooking volume(Approx)		1.0 L	1.8 L
Nominal volume of the pan(Approx)		3.2 L	4.8 L
Cooking quantity (Rice)(Approx) L (cup)	White Regular	0.18-0.99[1-5 1/2]	0.18-1.8[1-10]
	Quick	0.18-0.99[1-5 1/2]	0.18-1.44[1-8]
	Quinoa	0.18[1], add 1.5 cups of water	0.18[1], add 1.5 cups of water
	Sticky Rice	0.18-0.54[1-3]	0.18-1.08[1-6]
	Brown Rice		
	Multigrain		
Porridge cooking volume (Rice) (Approx) L(cup)	Porridge	0.09-0.18[1/2-1]	0.09-0.36[1/2-2]
Maximum cooking volume (ingredients +water) L	The maximum waterline of "Porridge"	1.5	2.5
	MAX	2.1	-
Maximum weight of cake batter/ bread batter (Approx)g		500	700
Power cord length (Approx)m		0.9	
Weight (Approx)kg		2.8	3.2
Size (Approx)mm	Depth	302	
	Width	271	
	Height	194	239

- Please make sure to use this product in areas under 2000 meters above sea level to avoid affecting cooking performance.

Notes

A series of horizontal dashed lines for writing notes. The lines are evenly spaced and extend across the width of the page.

Notes

A series of horizontal dashed lines for writing notes.

Panasonic Warranty

Small Kitchen Appliances 12 Month Warranty from Date of Purchase ("Warranty Period")

Microwave Oven, Rice Cooker, Bread Maker, Benchtop Oven and Stick Blenders

1. This warranty does not exclude, restrict or modify in any way other rights and remedies under the law which relates to the product, including any non-excludable statutory guarantees in Australia.
2. Subject to the conditions of this warranty and during the Warranty Period, Panasonic or its Authorised Service Centre will perform the necessary service on the product without charge for parts or labour, if in the opinion of Panasonic, the product is found to be faulty within the Warranty Period.
3. This warranty only applies to Panasonic products purchased in Australia and sold by Panasonic Australia or its Authorised Distributors or Dealers and only where the products are used and serviced within Australia or its territories. Warranty cover only applies to service carried out by a Panasonic Authorised Service Centre and only if valid proof of purchase is presented when warranty service is requested.
4. This warranty only applies if the product has been used in accordance with the manufacturer's recommendations (as noted in the Operating Instructions) under normal use and reasonable care (in the opinion of Panasonic). The warranty covers normal domestic use only and does not cover damage, malfunction or failure resulting from:
 - (a) misuse, abuse, neglect, accidental damage or modifications;
 - (b) infestation by insects or vermin;
 - (c) incorrect installation, assembly, improper voltage, or mains supply problems;
 - (d) natural disaster or acts of God (e.g. lightening, flood, fire, earthquakes etc);
 - (e) rust or damage caused by exposure to abnormally corrosive conditions;
 - (f) an accessory, component or other equipment not supplied by Panasonic Australia;
 - (g) improper maintenance by the customer (refer to the maintenance section of the Operating Instructions) which includes but is not limited to the failure to undertake the following actions:
 - (i) regular cleaning; and
 - (ii) where filters are included, regular cleaning and replacement of filters where necessary.
 - (h) incorrect operation of the product; and
 - (i) where no actual fault of the product is determined to have occurred, during a customer-initiated service call, and where the perceived problem is explained within the Operating Instructions (including the troubleshooting section) warranty service is not applicable
5. This warranty does not cover the following items unless the fault or defect existed at the time of purchase:
 - (a) Cabinet or Casing Parts
 - (b) Noise or vibration that is considered normal
 - (c) User replaceable Batteries
 - (d) Kneader mounting shaft unit and heads, blades and other accessories
 - (e) Microwave Oven cook plates
6. You will be responsible for costs associated with making the warranty claim where there are costs associated with shipping or handling or travelling outside of the area normally serviced by Panasonic or any repair agent authorised by Panasonic.
7. To the extent permitted by law and subject to your non-excludable statutory rights and guarantees, Panasonic excludes all warranties and liabilities (other than those contained in this warranty) including any liability for loss or damage whether direct or indirect arising from your purchase, use or non-use of the product.
8. In addition to your rights under this warranty, Panasonic products come with consumer guarantees that cannot be excluded under the Australian Consumer Law. You are entitled to a replacement or refund for a major failure and compensation for any reasonably foreseeable loss or damage. You are also entitled to have the product repaired or replaced if the product fails to be of an acceptable quality and the failure does not amount to a major failure.
9. To claim warranty service, when required, you should:
 - Contact Panasonic's Customer Care Centre on 132 600 for Authorised Service Centre information
 - Send or take the product to a Panasonic Authorised Service Centre together with your purchase receipt as a proof of purchase date.

THIS WARRANTY CARD AND THE PURCHASE DOCKET (OR SIMILAR PROOF OF PURCHASE) SHOULD BE RETAINED BY THE CUSTOMER AT ALL TIMES

If you require assistance regarding warranty conditions or any other enquiries, please visit the **Panasonic Australia** website www.panasonic.com.au or contact by phone on **132 600**
If phoning in, please ensure you have your operating instructions available.

Panasonic Australia Pty. Limited

ACN 001 592 187 ABN 83 001 592 187

1 Innovation Road, Macquarie Park NSW 2113
www.panasonic.com.au

Panasonic Warranty

Home Appliance 24 Month Warranty from Date of Purchase

1. Subject to the conditions of this warranty Panasonic or its Authorised Service Centre will perform necessary service on the product without charge for parts or labour, if in the opinion of Panasonic, the product is found to be faulty within the warranty period. For Line Communications products (i.e. Cordless Phones, etc) the genuine battery(s) has a 3 month warranty.
2. This warranty only applies to Panasonic products purchased in New Zealand and sold by Panasonic New Zealand or its Authorised Distributors or Dealers and only where the products are used and serviced within New Zealand or its territories. Warranty cover only applies to service carried out by a Panasonic Authorised Service Centre and only if valid proof of purchase is presented when warranty service is requested.
3. This warranty only applies if the product has been installed and used in accordance with the manufacturer's recommendations (as noted in the operating instructions) under normal use and reasonable care (in the opinion of Panasonic). The warranty covers normal domestic use only (also Clip & Trim Professional use) and does not cover damage, malfunction or failure resulting from use of incorrect voltages, incorrect installation, accident, misuse, neglect, build-up of dirt or dust, abuse, maladjustment of customer controls, mains supply problems, thunderstorm activity, infestation by insects or vermin, tampering or repair by unauthorised persons (including unauthorised alterations), exposure to abnormally corrosive conditions or any foreign object or matter having entered the product.
4. This warranty does not cover the following items unless the fault or defect existed at the time of purchase:
 - (a) Cabinet Parts
 - (b) Microwave Oven cook plates.
 - (c) User replaceable Batteries
 - (d) Kneader mounting shaft unit and Heads, Cutters, Foils, Blades and other accessories.
 - (e) Noise or vibration that is considered normal
 - (f) Wear and tear from normal use
5. To claim warranty service, when required, you should:
 - Telephone Panasonic's Customer Care Centre on 09 2720178 or visit our website referred to below and use the Service Centre Locator for the name/address of the nearest Authorised Service Centre.
 - Send or take the product to a Panasonic Authorised Service Centre together with your proof of purchase receipt as a proof of purchase date. Please note that freight and insurance to and / or from your nearest Authorised Service Centre must be arranged by you.
6. The warranties hereby conferred do not extend to, and exclude, any costs associated with the installation, de-installation or re-installation of a product, including costs related to the mounting, de-mounting or remounting of any screen, (and any other ancillary activities), delivery, handling, freighting, transportation or insurance of the product or any part thereof or replacement of and do not extend to, and exclude, any damage or loss occurring by reason of, during, associated with, or related to such installation, de-installation, re-installation or transit.

Panasonic Authorised Service Centres are located in major metropolitan areas and most regional centres of New Zealand, however, coverage will vary dependant on product. For advice on exact Authorised Service Centre locations for your product, please telephone our Customer Care Centre on 09 2720178 or visit our website and use the Service Centre Locator.

Unless otherwise specified to the consumer the benefits conferred by this express warranty are additional to all other conditions, warranties, guarantees, rights and remedies expressed or implied by the Consumer Guarantees Act of New Zealand and all other obligations and liabilities on the part of the manufacturer or supplier and nothing contained herein shall restrict or modify such rights, remedies, obligations and liabilities.

THIS WARRANTY CARD AND THE PURCHASE DOCKET (OR SIMILAR PROOF OF PURCHASE) SHOULD BE RETAINED BY THE CUSTOMER AT ALL TIMES

If you require assistance regarding warranty conditions or any other enquiries, please visit the **Panasonic New Zealand** website www.panasonic.co.nz or contact by phone on **09 2720178**
If phoning in, please ensure you have your operating instructions available.

Panasonic New Zealand Customer Care Centre

Phone: 09 2720178

Fax: 09 2720129

Email: customerservice@nz.panasonic.com

Website: www.panasonic.co.nz/support