

Operating Instructions

LED TV

32-inch model



43-inch model



English

Thank you for purchasing this Panasonic product.
Please read these instructions carefully before operating
this product and retain them for future reference.

The images shown in this manual are for illustrative
purposes only.
Some illustrations are presented as conceptual images
and may be different from the actual products.
Illustrations shown may be different between models
and countries.

**The illustrations for 43-inch model is used in this
manual unless otherwise mentioned.**

Transport only in upright position

Important Notice

Panasonic does not guarantee operation and performance of peripheral devices made by other manufacturers; and we disclaim any liability or damage arising from operation and/or performance from usage of such other maker's peripheral devices.

Handling of customer information

The recording and playback of content on this or any other device may require permission from the owner of the copyright or other such rights in that content. Panasonic has no authority to and does not grant you that permission and explicitly disclaims any right, ability or intention to obtain such permission on your behalf. It is your responsibility to ensure that your use of this or any other device complies with applicable copyright legislation in your country. Please refer to that legislation for more information on the relevant laws and regulations involved or contact the owner of the rights in the content you wish to record or playback.

This product is licensed under the AVC patent portfolio license for the personal and non-commercial use of a consumer to (i) encode video in compliance with the AVC Standard ("AVC Video") and/or (ii) decode AVC Video that was encoded by a consumer engaged in a personal and non-commercial activity and/or was obtained from a video provider licensed to provide AVC Video. No license is granted or shall be implied for any other use.

Additional information may be obtained from MPEG LA, LLC.

See <http://www.mpegla.com>.

Panasonic and its affiliates make no representations or warranties of any kind with respect to the USB devices and the performance of communication between the USB devices and the USB port of Panasonic products, and expressly disclaims any and all warranties, whether express or implied or otherwise, including without limitation any implied warranty of fitness for a particular purpose, any loss of data, and any implied warranties arising from course of dealing or course of performance of data communication between the USB devices and the USB port of Panasonic products.

Transport only in upright position.



This mark indicates the product operates on AC voltage.



This mark indicates a Class II or double insulated electrical appliance wherein the product does not require a safety connection to electrical earth (ground).

Contents

Safety Precautions	3
Setting Up the TV	4
Connecting the TV	6
Initial Setup	8
Operating the TV	10
Watching External Inputs	11
Using Homepage - Apps	12
Using the Menu Functions	13
Using Media Player	15
Additional Information	16
Troubleshooting	20
Maintenance	21
Specifications	22

Safety Precautions

To help avoid risk of electrical shock, fire, damage or injury, please follow the warnings and cautions below:

Mains plug and lead

Warning

If you detect anything unusual, immediately remove the mains plug.

- Mains plug types vary between countries.

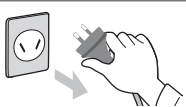

- This TV is designed to operate on AC 100 - 240 V, 50/60 Hz.
- Insert the mains plug fully into the socket outlet.
- Ensure that the mains plug is easily accessible.
- Disconnect the mains plug when cleaning the TV.
- Do not touch the mains plug with wet hands.



- Do not damage the mains lead.
 - Do not place a heavy object on the lead.



- Do not place the lead near a high temperature object.



- Do not pull on the lead. Hold onto the mains plug body when disconnecting the plug.



- Do not move the TV with the lead plugged into a socket outlet.
- Do not twist the lead, bend it excessively or stretch it.
- Do not use a damaged mains plug or socket outlet.
- Ensure the TV does not crush the mains lead.
- Do not use any mains lead other than that provided with this TV.

Take care

Warning

- Do not remove covers and never modify the TV yourself as live parts are accessible when they are removed. There are no user serviceable parts inside.
- Do not expose the TV to rain or excessive moisture. This TV must not be exposed to dripping or splashing water and objects filled with liquid, such as vases, must not be placed on top of or above the TV.



- Do not insert foreign objects into the TV through the air vents.
- Do not use an unapproved pedestal / mounting equipment. Be sure to ask your local Panasonic dealer to perform the setup or installation of approved wall-hanging brackets.
- Do not apply strong force or impact to the display panel.
- Do not place the TV on sloped or unstable surfaces, and ensure that the TV does not hang over the edge of the base.



- This TV is designed for table-top use.
- Do not expose the TV to direct sunlight and other sources of heat.



To prevent the spread of fire, keep candles or other open flames away from this product at all times



Dangerous part / Small object

Warning

- This product contains possibly dangerous parts such as plastic bags, that can be breathed in or swallowed by young children accidentally. Keep these parts out of reach of young children.

Pedestal

Warning

- Do not disassemble or modify the pedestal.

Caution

- Do not use any pedestal other than the one provided with this TV.
- Do not use the pedestal if it becomes warped or physically damaged. If this occurs, contact your nearest Panasonic dealer immediately.
- During setup, make sure that all screws are securely tightened.
- Ensure that the TV does not suffer any impact during installation of the pedestal.
- Ensure that children do not climb onto the pedestal.
- Install or remove the TV from the pedestal with at least two people.
- Install or remove the TV by the specified procedure.

Ventilation

Caution

Allow sufficient space around the TV in order to help prevent excessive heat, which could lead to early failure of some electronic components.

Minimum distance (cm)

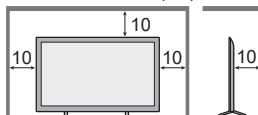

- Ventilation should not be impeded by covering the ventilation openings with items such as newspapers, tablecloths and curtains.



- Whether you are using a pedestal or not, always ensure the vents at the bottom of the TV are not blocked and there is sufficient space to enable adequate ventilation.

■ Moving the TV

Caution

Before moving the TV, disconnect all cables.

- Move the TV with at least two people. Support as shown to avoid injury by the TV tipping or falling.

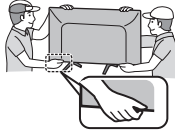

■ When not in use for a long time

Caution

This TV will still consume some power even in the Off mode, as long as the mains plug is still connected to a live socket outlet.

- Remove the mains plug from the wall socket when the TV is not in use for a prolonged period of time.

■ Battery for the Remote Control

Caution

- Incorrect installation may cause battery leakage, corrosion and explosion.
- Replace only with the same or equivalent type.
- Do not mix old and new batteries.
- Do not mix different battery types (such as alkaline and manganese batteries).
- Do not use rechargeable batteries (Ni-Cd, etc.).
- Do not burn or break up batteries.
- Do not expose batteries to excessive heat such as sunshine, fire or the like.
- Make sure you dispose of batteries correctly.

■ Prevention of Dumping

Caution

- Please use the screw in the wall-mount hole of the back cover with the restraining bracket and rope to make sure that it is firmly tied and fixed on the table and other solid position.

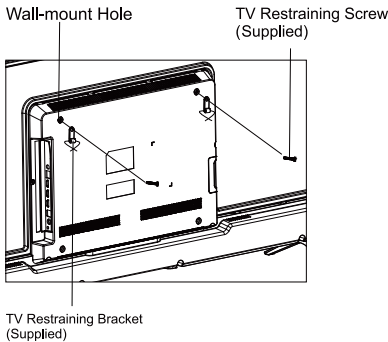

Setting Up the TV

Supplied accessories

Accessories may not be placed all together. Take care not to throw them away unintentionally.

Operating Instructions

Remote Control

- RC870PN



Batteries (AAA) × 2

- ➔ (p.5)



Mini Jack Adapter

- Adapter AV



Pedestal

32-inch model

- Base

- Assembly screws

A  (ST4 x 15) x 4



Pedestal

43-inch model

- Base

- Assembly screws

A  (ST4 x 20) x 4



Anti-falling accessories

Bracket x 2
Rope x 2

Attaching the pedestal

1 Assemble the pedestal

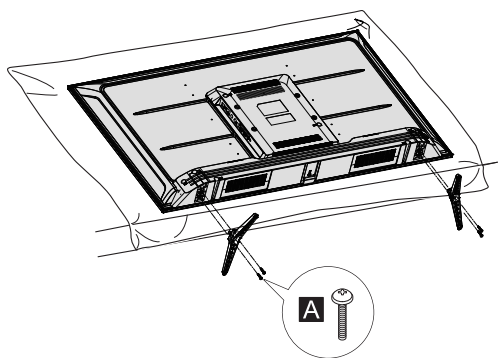

Removing the pedestal from the TV

Be sure to remove the pedestal in the following way when using the wall-hanging bracket or repacking the TV.

1 Lay the TV on a foam mat or thick soft cloth on a table.

2 Remove the assembly screws **A** from the TV.

Inserting remote's batteries

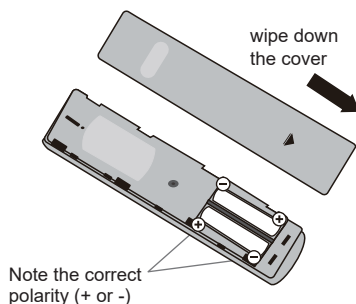

Wall mounting the TV (optional)

Please contact your local Panasonic dealer to purchase the recommended wall-hanging bracket.

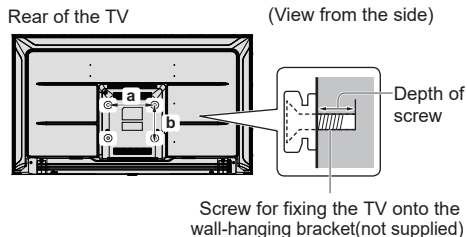

Holes for wall-hanging bracket installation

Model	a	b
32-inch	100 mm	100 mm
43-inch	200 mm	100 mm

Screw specification

Model	Type	Depth of screw	
		Minimum	Maximum
32-inch	M4	6 mm	10 mm
43-inch	M6	11 mm	12 mm

Warning

- When optional accessories such as wall brackets etc. are used, always read and follow the manufacturer installation and usage instructions.
- Do not mount the unit directly below ceiling lights (such as spotlights or halogen lights) which typically give off high heat. Doing so may warp or damage plastic cabinet parts.
- When installing wall brackets you must ensure the wall bracket is not electrically grounded to metal wall studs. Always ensure that there are no electrical cables, pipes etc. in the wall before you begin the wall bracket installation.
- To prevent fall and injury, remove the TV from its fixed wall position when it is no longer in use.

Connecting the TV

- Please ensure the TV is disconnected from the mains socket/ power point before attaching or disconnecting any RF/ AV leads.
- External equipment and cables are for illustrative purposes only and not supplied with this TV.
- Check the type of terminals and cable plugs are correct when connecting.
- When using an HDMI cable, use the fully wired one.
- Keep the TV away from electronic equipment (video equipment, etc.) or equipment with an infrared sensor. Otherwise, distortion of image/ sound may occur or operation of other equipment may be interfered.
- Also read the manual of the equipment being connected.

Terminals

Rear of the TV

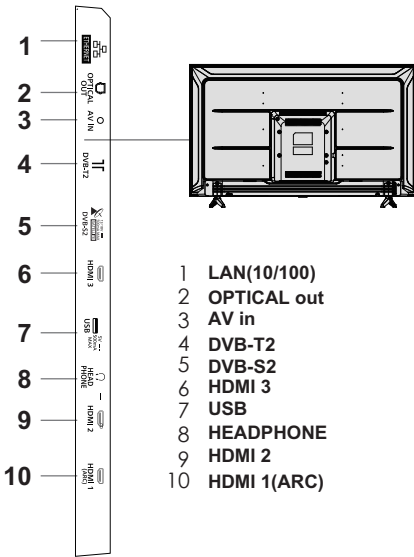

Connections

Aerial

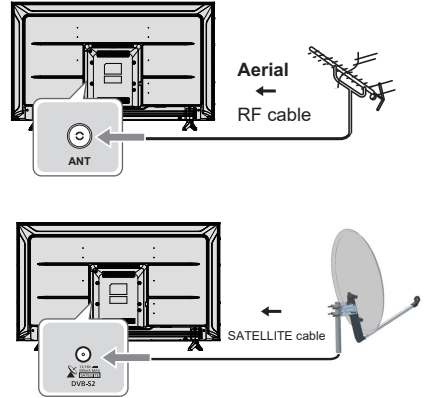

This TV has a satellite tuner, for receiving free satellite channels without the need for an external satellite set-top box or a dedicated remote control for watching by satellite.

- Keep RF (aerial) cable away from the mains lead to avoid and minimise mains interference pickup.
- Do not place the RF cable under the TV.
- An aerial, correct cable (75 Ω coaxial) and correct terminating plug are required to obtain optimum quality picture and sound.
- If a communal aerial system is used, you may require the correct connection cable and plug between the wall aerial socket and the TV.
- Your local Television Service Centre or dealer may be able to assist you in obtaining the correct aerial system for your particular area and the accessories required.
- Any matters regarding aerial installation, upgrading of existing systems or accessories required, and the costs incurred, are the responsibility of you, the customer.
- If the aerial is placed in the wrong location, interference might happen.

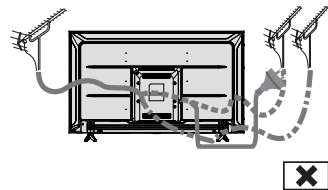
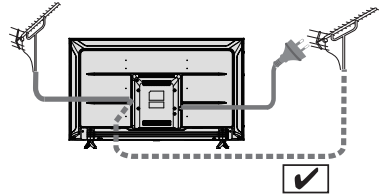

Blu-Ray Player

TV

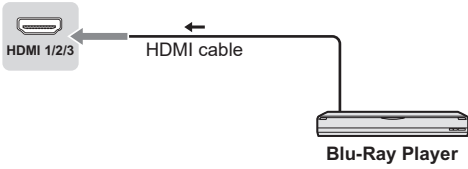

AV / Game equipment

Using HDMI terminal

TV

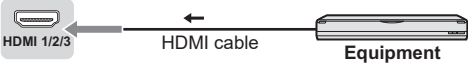

Using AV terminals

TV

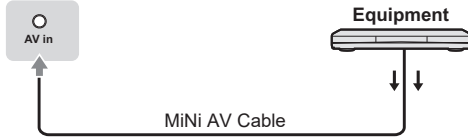

DVD Recorder / VCR

TV

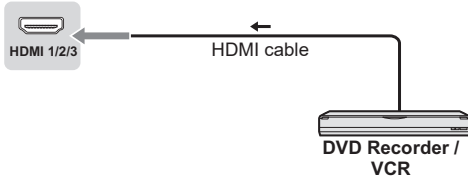

Set top box

TV

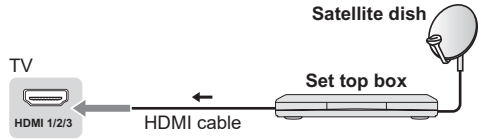

Speaker system

TV

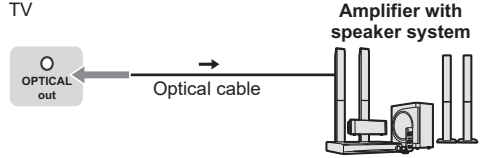

- To enjoy the sound from the external equipment in multi-channel sound (e.g. Dolby Digital 5.1ch), connect the equipment to the amplifier. For the connections, read the manuals of the equipment and amplifier.

Initial Setup

Plug the mains plug into the socket outlet and turn on the TV.

It may take a few seconds before the screen is displayed.

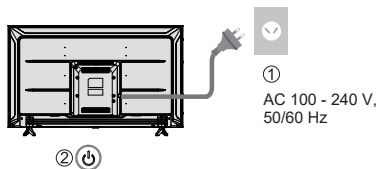

Google - Initial Setup

When you turn on the TV for the first time, there will show a wizard to guide you to finish the following initial settings:

Step 1: Select the menu language as you need.

Note: English(New Zealand) is recommended.

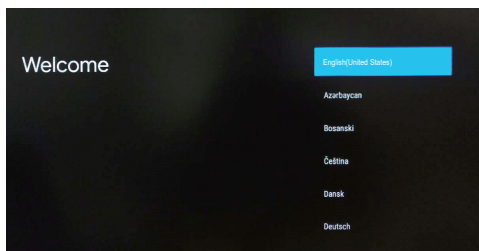

Step 2: (Only for some countries) Select whether or not to use and Android device to setup the TV.

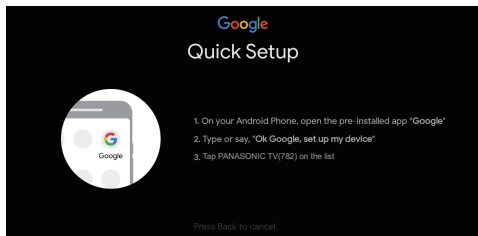
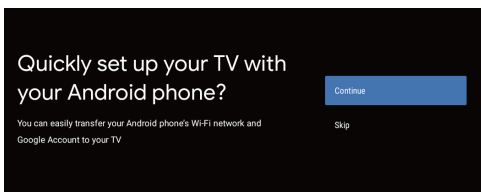

Note: If you don't want to use your Android device to setup the TV, you will skip to Step 3. If you want to use your Android device to setup the TV, please turn on the Bluetooth functions of your Android phone, then find and open "Google" application on your phone. Follow the instruction tips to set device.

Step 3: Select whether or not to connect your TV set to the WLAN network.

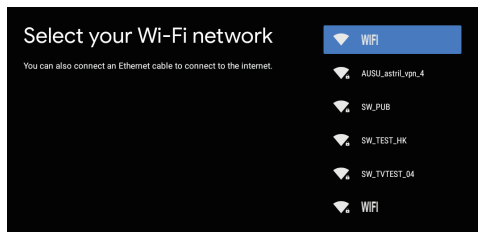

Note: If you have connected the TV to the Wi-Fi network, it will check for updates like Google service updates and so on. Then please select whether or not to sign in to your Google account.

Step 4: Read to accept the Google terms of service and privacy policy.

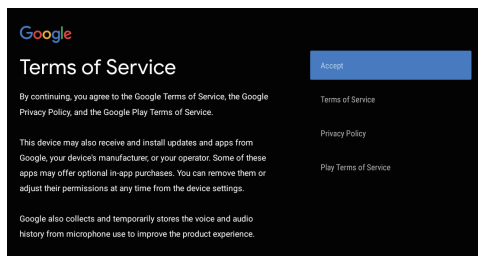

Step 5: Select whether or not to let Google or third party to use your TV location.

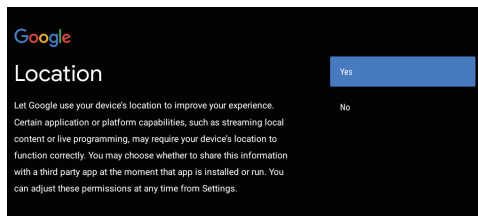

Step 6: Select whether or not to allow Google to help improve your Android TV.

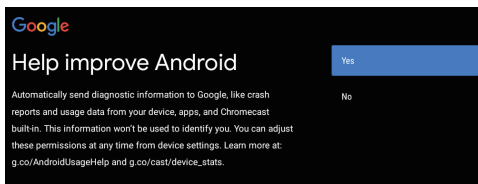

Initial Setting

Initial setup involves selecting all the settings required to be able to search for and store all the analogue channels you can receive.

Make sure that the television is switched on and follow all the steps in turn specified hereafter.

The first time you switch the set on, the Initial Setup wizard opens, which guides you through the initial setup process.

Step 1: Environment

Press ▲/▼ to select your environment. Then press OK to enter next step.

Home Mode: You would be able to view the standard settings for Picture and sound modes.

Shop Mode: You can enjoy enhanced setting for Picture and Sound modes.

Note: Picture mode setting will not be accessible when you select Shop Mode.

Step 2: Where are you?

Press ▲/▼ to select your Country/Region. Press OK to confirm and move to next step.

Step 3: Terms & Conditions

Use ▲/▼ to read Terms & Conditions, then press OK to confirm and move to next step.

Step 4: Channel installation

Use ▲/▼ to select Tuner mode: Antenna, Cable, Satellite. Type: Digital, Analogue and All, then press OK to confirm and move to next step.

Step 5: Please check settings

When all setup is done, the [Please check settings] interface displays on the screen, and press OK to finish the initial setup. You can also go back to former step and make any changes by using ←-button.

Step 1:

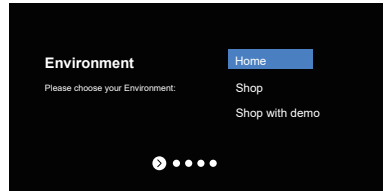

Step 2:

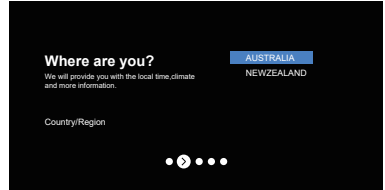

Step 3:

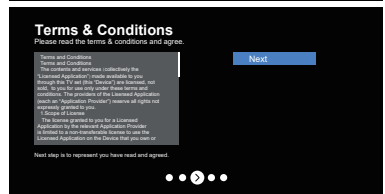

Step 4:

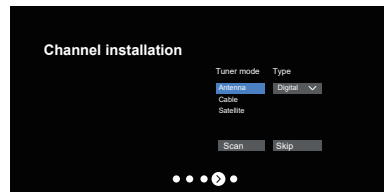

Step 5:

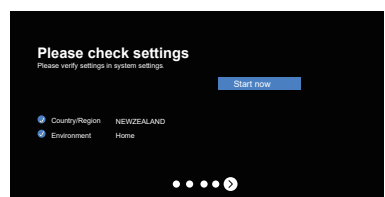

Setup is now complete and your TV is ready for viewing.

Note













- If tuning has failed, check the connection of the RF cable, then follow the on-screen instructions.

Operating the TV

Using the remote control

Remote Control Functions



Most of your television's functions are available via the menus that appear on the screen. The remote control supplied with your set can be used to navigate through the menus and to configure all the general settings.

- POWER**  (On/Off button) Turns the TV on or off.
-  To mute and un-mute the sound.
-  Goes to the smart TV homepage.
-  Enter into Quick Access Menu.
-  (up, down, left and right direction buttons) Highlights different items in the menu system and adjusts the menu controls.
- OK** Confirms your selection.
-  Exit the menu and return to the previous menu.
-  To enter source selection interface.
-  (Mic) Click to interact with Google Assistant of the TV. (Available only when the network connection is normal.)
-  To Enter into virtual keyboard.
-  To enter the two-way Bluetooth interface.
-  Enter into Using TV System menu.
-  Increases or decreases the TV's volume.
- P +/-** Adjusts the TV's channel.
-  Goes to the YouTube homepage.
- NETFLIX** Goes to the NETFLIX homepage.







How to Pair Remote Control with the TV

This is a Bluetooth remote control, and before using it, please pair it with the TV firstly. The following steps are for your reference:

- Step 1:** Press  button to enter the home page.
- Step 2:** Press  button to enter the "RC pairing".
- Step 3:** Follow the "Settings tips page", Press **OK** and  together.
- Step 4:** The screen will display "Pairing...", Pair finished the screen will display "Success!".

NOTE: If you wait more than 2 minutes and it can't pair, please repeat the above steps for pairing again.

If you want to unpair the Bluetooth remote, As follow:

- Step 1:** Press  button to enter the home page.
- Step 2:** Press  to choose , and then press **OK** to enter.
- Step 3:** Press  to select "Remotes & Accessories" and then to choose the Bluetooth remote name to enter next steps.
- Step 4:** Press unpair and then choose **OK** button.

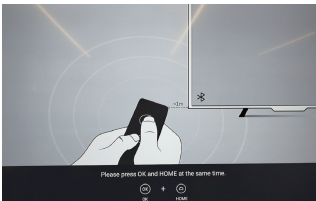

Watching External Inputs

1 Connect the external equipment.
→ (p. 6 - 7)

2 Display the [Input] menu, then select the input of the connected equipment.

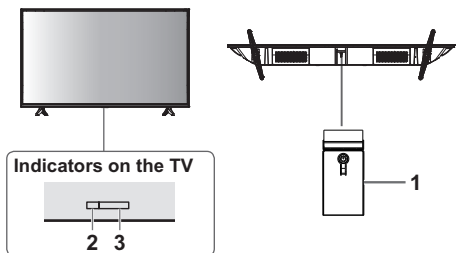

1 Power On /Power Off

2 Power LED

- Red: Standby
- Green: On

3 Remote control signal receiver

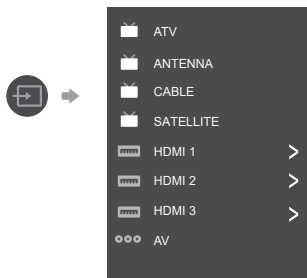

Press OK key only can access.

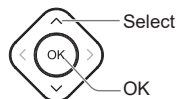

Note





- If the external equipment has an aspect adjustment function, set it to "16:9".

Using Homepage - Apps



Note: This manual is for common use. Figures and illustrations in this User Manual are provided for reference only and may differ from actual product appearance. And for some models, certain options are not available.

You can select all the features from homepage.

Press  to display homepage.

Press /// to select icons from the screen list.

Press **OK** to enter each option.

To exit the APP, press  or .

Google Assistant: Click to interact with Google Assistant of the TV.

Notifications: Remind you of system-critical information, such as low disk space, Google sign in or account errors, network connectivity issues, etc.

Input: Select the input source.

Settings: Access the system setting.

Apps: Show the list of favorite applications, or access the application center.

CUSTOMISE CHANNELS: Add and remove channels from your Home screen.

Note:





- 1) The functions and contents of "Home Page" may vary by different countries or models.
- 2) Before using network functions in home page like network applications and so on, please connect the TV to the network firstly.
- 3) Icon copyrights are owned by the application providers.

Using the Menu Functions

Using Quick Access Menu

Note: Some of the functions might be unavailable in certain sources. And for some models, certain options are not available.

This section explores the menus and settings of your TV. Each menu is outlined and detailed to help you get the most from your TV. To access the menu system:

1. In TV mode, press  on the remote control to display the quick access list.
2. Press  to select the desired item, then press **OK** to open the corresponding submenu.
3. In submenu, use  and **OK** buttons to make the adjustments, or use  to select an item, use **OK** to enter and operate according to the on-screen display or guide.
4. Press  to return to the previous menu.

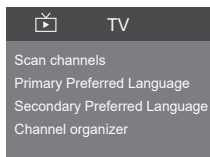
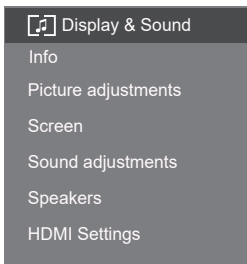

Display & Sound

Info: Select this option to view TV information.

Picture adjustments: Enter to adjust picture mode or Advanced settings.

Screen: Select this option to adjust the picture size.

Sound adjustments: Select this option to set the sound adjustments.

Speakers: To enter TV speaker settings.

HDMI Settings: Enter to set up HDMI devices for streamlined control.

TV

Scan channels: To setup Analogue or Digital channels.

Primary Preferred Language: Press  and **OK** to set Primary Preferred Language. (Only for audio language)

Secondary Preferred Language: Press  and **OK** to set Secondary Preferred Language. (Only for audio language)

Channel organizer: Highlight the channels you want to edit, then use the arrow keys to edit the channel.



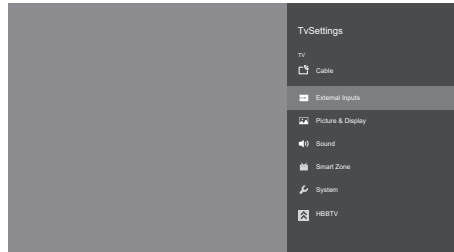

Using TV Settings

The Settings menu allows you to configure the TV with your preferences.

Note: Some of the functions might be unavailable in certain sources. And for some models, certain options are not available.



TV. Each menu is outlined and detailed to help you get the most from your TV. To access the menu system:

1. Press  to select the desired item, then press **OK** to open the corresponding submenu.
2. In submenu, use  and **OK** buttons to make the adjustments, or use  to select an item, use **OK** to enter and operate according to the on-screen display or guide.
3. Press  to return to the previous menu.

Cable/Antenna

Digital Setup

- Digital Antenna Tuning: Select Auto Tune and press **OK** to start the automatic search process. The search may take a few minutes. During the process, you can press  and choose YES to exit.

- Subtitle Setup:

(1) **Subtitle Setting:** Include Off, Basic and Hearing Impaired

(2) **Primary Preferred Language:**

Press  and **OK** to set Primary Preferred Language.

(3) **Secondary Preferred Language:**

Press  and **OK** to set Secondary Preferred Language.

- Teletext Setup

(1) **Preferred teletext:** Press **OK** and then use  to select Preferred teletext.

(2) **Decoding page language:** Press **OK** and then use  to select Decoding page language.

- Audio Setup

(1) **Dialpque Enhancement:** Press **OK** and then use  to select On/Off.

(2) **Dialpque Enhancement Level:** Press  to adjust Dialpque Enhancement Level.

(3) **Audio Description:** Include Off and On.

(4) **Audio Description Mixing Level:**

Press **OK** and then use  to set Audio Description Mixing Level.

(5) **Audio Type:** Include Normal and Hearing Impaired.

(6) **Primary Preferred Language:**

Press  and **OK** to set Primary Preferred Language.

(7) **Secondary Preferred Language:**

Press  and **OK** to set Secondary Preferred Language.

Satellite Setting

1. Selection of Digital Setup.
2. Pushing OK in Digital Setup moves to Digital Satellite Tuning.
3. Pushing OK in Digital Satellite Tuning moves to Satellite Tune.
4. Pushing OK in Satellite Tune moves to UI with Satellite, Transponder and Optus D1 columns (below UI).
5. Satellite 01 Ku-Optus D1 has to be selected by OK for Freeview service tuning.
6. Transponder 001 12483 H 22500 has to be selected by OK to display the popup message.

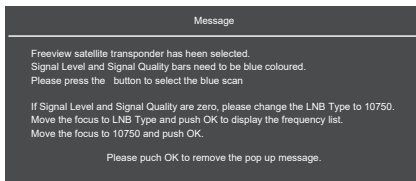
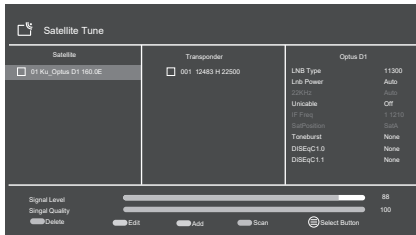

7. Above message is displayed after the Transponder 001 12483 H 22500 is selected the popup message is displayed.
8. Pushing OK removes the popup message.
9. After the message is cancelled, press **Enter** on the remote control to then goes directly to the blue Scan button. (see below UI)

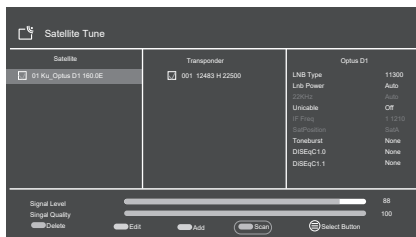

10. Pressing OK when the focus is on Scan results in Freeview tuning channel search to be displayed. (see below UI)

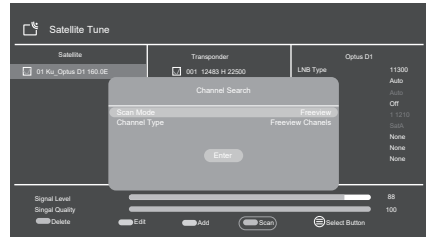

11. The focus is on Freeview. Move the focus down to Enter and push OK.
12. The Select Region is displayed.

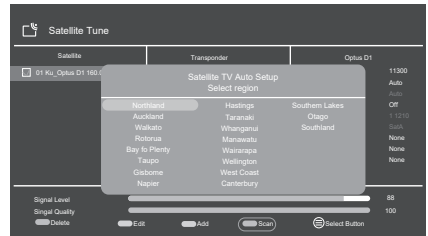

13. Move the focus to the region where you are resident and push OK.
14. After the region selection is done, the satellite tuning scan commences.
15. There is a serious problem if the viewer pushes directly without selecting and getting a tick in the box for Optus D1 and transponder 12483MHz. The tuning jumps directly to below tuning menu that does not allow selection of Freeview.

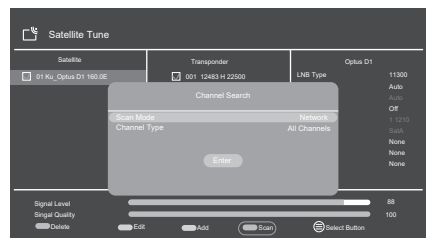

External Input

HDMI CEC Settings:

- CEC Control: Enter to select on or off.
- Device AUTO POWER Off: Power off HDMI devices with the TV.
- TV Auto Power On: Power on the TV with a connected HDMI device.
- CEC Device List: Turn devices on and select [Enable] to enable control of HDMI devices.
- Device Control Keys: Pass through addition remote buttons to cec compatible devices.

Support HDMI Mode

Include 1.4.

Picture & Display

Picture Adjustment:

- Picture Mode: Optimize picture quality for general content. Use ▲/▼ to scroll through the Picture preset settings: Standard, Dynamic, Movie, Sport and Personal.
- HDMI Mode: Adjust the HDMI Mode. Use ▲/▼ to select Video, PC and Auto.
- Advanced Settings: Access advanced picture enhancing options.
- Brightness: Adjusts the brightness of the picture.
- Color: Adjusts the color saturation.
- Clarity: Advanced technique for picture enhancement.
- Reset: To reset picture adjustment.

Display Setting:

- Screen mode: adjust the picture size. Use ▲/▼ to scroll the Screen mode preset settings.
- Auto screen: Automatically adjusts screen mode based on the signal. Include On and Off.
- Overscan: Adjust overscan display, include on/off.

Sound

Sound Adjustment: Adjust sound and speaker-related options.

- Sound Mode: Optimize sound quality for general content. Use ◀/▶ to scroll through the sound preset settings.
- Surround: Reproduces life-like surround sound when playing 5.1-channel audio sources. Include On and Off.
- Advanced Setting: Access advanced sound enhancing options.

Volume Setting:

- 1) *Auto Volume:* Keeps the volume level constant for all programs and inputs. Include Auto and Off.
- 2) *Balance:* Adjust the speaker balance.
- 3) *Digital Audio Out Volume:* Applied for PCM only. The volume levels between PCM and compressed audio will differ.
- 4) *Digital Audio Out Delay:* Set the delay time for Digital Audio.
- 5) *Volume offset:* Adjust the sound level of the current input relative to other inputs.

Sound mode related:

1) *Surround effect:* Use ◀/▶ to set Surround effect.

Reset: To reset all Sound adjustment settings.

Digital Audio Out: Optical out for audio signals from the Digital Audio Out. Include Auto, PCM and DD+.

Smart Zone

Enjoy Music: Select this option to enter into Audio Only mode.

Fast Cast: An app that quickly delivers mobile content to TV, allowing users to quickly deliver multimedia content such as photos, videos, musics and more to TV terminals.

Fast Cast Step:

1. Download Fast Cast mobile App.
2. Mobile and TV are connected the Same Wi-Fi.
3. Search device and connect TV.

Note:

1. *This function may be unavailable for some mobile devices, and it subject to chipset support the files format.*

2. *Recommendations of working environments:*

Local Area Network Speed recommendations on: 1M/S~2M/S.

Sleep Timer: Use ▲/▼ to scroll through the sleep timer settings.

World clock: Enter to add World clock.

Night mode: Turn on to Keep loudness and brightness to prevent disturb others. Clear sound and brightness at a low level.

System

Language: Use ▲/▼ to scroll through Language.

Environment: Enter to set Home or shop mode.

- Home Mode: You Would be able to view the standard settings for Picture and Sound Modes.

- Shop Mode: You can enjoy enhanced setting for Picture and Sound Modes.

Note: Picture mode setting will not be accessible when you select Shop Mode.

Shop Demo: Enter to set E-sticker.

Power: Enter to set Power mode.

- Wake on Wireless LAN: Enable wake on WIFI Settings.

- Network stand by: Enable STR Settings.

Sleep Timer: Set the TV to turn off automatically.

Idle TV standby: Select the inactivity time that TV enter standby.

Available space: Show system and memory free space.

Smart TV Manual: Show the guide to get smart TV manual by smartphone.

Using Media Player

Media Player allows you to enjoy photo, music or video recorded on a USB Flash Memory.

- The picture may not appear correctly on this TV depending on the digital cameras used.
- Display may take some time when there are many files and folders in the USB Flash Memory.
- Partly degraded files might be displayed at a reduced resolution.
- The folder and file names may be different depending on the digital camera used.

Inserting / Removing the USB Flash Memory

TV

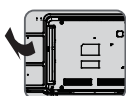
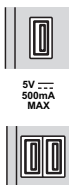

- Insert or remove straight and completely.



Additional Information

Starting Media Player

1 Insert the USB Flash Memory.

2 Select the mode.



[DOCUMENT]: Displays the thumbnail of all files in the USB Flash Memory.

[PHOTO]: Displays the thumbnail of all photos in the USB Flash Memory.

[MUSIC]: Displays the thumbnail of music folders in the USB Flash Memory.

[VIDEO]: Displays the thumbnail of video titles in the USB Flash Memory.

[DISK]: Displays the thumbnail of all document in the USB Flash Memory.

[Contents Display]

Follow the operation guide to perform available operations.

When the cursor stays on the icon, it displays the information of the highlighted content.

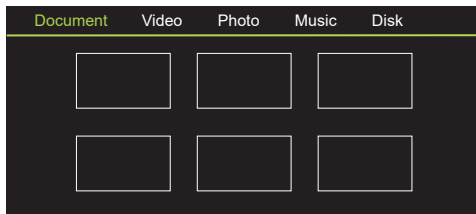

Video:

1. Select Video icon, then press OK button to view movie file.
2. Press Up, Down, Left or Right direction button to select your desired file and press OK to Play.
3. While playing a Video, press OK Menu of remote to display the play console. For the Play console, Press Ok key of remote to Play and Pause the video file. Left key of remote to Fast backward. Right key of remote to Fast forward.
4. Use key to see more option: Photo scale, Looping mode, Subtitle, Subtitle code Audio track, info and Settings.
5. Press Return key of remote to Stop playing and Press Return to Exit.

Photo:

1. Select Picture icon, then press OK button to view the picture.
2. Press Up, Down, Left or Right direction button to select your desired picture file and press OK to show.
3. While showing picture, press OK to display the play console. For Previous and Next use remote left and Right key.
4. Use OK/ key to see more option: Left rotation, Right rotation, ZOOM+, ZOOM-, Manual play/Auto play, Information, Play interval, Play mode, BGM: on or off.

Music:

1. Select Music icon, then press OK button to listen to Music.
2. Press Up, Down, Left or Right direction button to select your desired file and press OK to Play.
3. The Play console includes Previous, Play/Pause, Fast backward/Fast forward, Next, Repeat. Press key to see PlayList.
4. Press Return key of remote to Stop playing.

Disk:

1. Select **Disk** icon, then press OK button to choose folder.
2. Press Up, Down, Left or Right direction button to select your desired file and press OK to Play.
3. Press Return key of remote to Stop playing.

Additional Information

Auto power standby function

The TV will automatically go into Standby mode in the following conditions:

- No signal is received for 15 minutes.
- [Sleep timer] is active in the [System] menu (p. 14).

Input signal that can be displayed

Signal name	HDMI
525 (480) / 60i, 60p	○
625 (576) / 50i, 50p	○
750 (720) / 60p, 50p	○
1,125 (1,080) / 60i, 50i	○
1,125 (1,080) / 60p, 50p, 24p	○

- Mark : Applicable input signal
- Signals other than above may not be displayed properly.
- The above signals are reformatted for optimal viewing on your display.

HDMI connection

This TV incorporates HDMI™ technology. HDMI (high-definition multimedia interface) is the world's first complete digital consumer AV interface complying with a non-compression standard.

HDMI allows you to enjoy high-definition digital images and high-quality sound by connecting the TV and the equipment.

■ Applicable HDMI features

- Input audio signal:
2ch Linear PCM (sampling frequencies - 48 kHz, 44.1 kHz, 32 kHz)
- Input video signal:
➔ **“Input signal that can be displayed” (p. 16)**
Match the output setting of the digital equipment.

USB Flash Memory

For playing back in Media Player

Format: FAT32

Compliance:

- Supports only USB1.1 or USB2.0 standard.
- Maximum USB capacity supported is 1TB.

Note

- Data modified with a PC may not be displayed.
- Do not remove the device while the TV is accessing data. Otherwise this can damage the device or TV.
- Do not touch the pins on the device.
- Insert the device in the correct direction. Otherwise this can damage device or TV.
- Electrical interference, static electricity, or erroneous operation may damage the data or device. Panasonic is not liable for any deterioration or damage of data or device during operations with the TV.
- It is recommended to connect the USB Flash Memory directly to the TV's USB port.
- Some USB devices or USB HUB may not be used with this TV.
- You cannot connect any devices by using USB card reader.
- Additional information for USB devices may be on the following website. (English only)
<http://panasonic.jp/support/global/cs/tv/>

Read Before Playing Photo, Video, or Music Files

Read this information before playing media content.

Limitations on use of photo, video, and music files

- The TV supports MSC(Mass Strong Class) USB devices only. MSC is a class designation for mass storage devices. Types of MSC devices include external hard drives, flash card readers, and digital cameras. (USB hubs are not supported.) These kinds of devices must be connected directly to the USB port. The TV may not be able to recognise a USB device or read the files on the device if it is connected with a USB extension cable. Do not disconnect USB devices while they are transferring files.
- When connecting an external hard drive, use the USB(HDD) port. We recommend that you use an external hard drive with its own power adapter.
- Certain digital cameras and audio devices may not be compatible with the TV.
- The TV supports the FAT file systems.
- After sorting files in the Folder view mode, the TV can display up to 1,000 files per folder. If the USB device contains more than 8,000 files and folders, however, some files and folders might not be accessible.
- Certain files, depending on how they are encoded, may not play on the TV.
- Certain files are not supported on all models.
- DivX and DTS codecs are not supported by the Panasonic.

Supported file format in Media Player

Licenses involved in specifications following are supposed to be obtained by customers.

*Need the specific chip and Hash Key to support.

1.Video

P/N	Video Decoder	Resolution	Max fps	Maxbitrate (Mbps)	Bit depth
MPEG 1/2/4	MPEG1; MPEG2 MP HL; MPEG-4 SP HL 3.0; MPEG-4 ASP HL 4.0	1920x1080	60	50 M	8
XviD	XviD				
H.264	H.264 BP LV 4.0	1920x1080	30	125 M	
	H.264 MP LV 4.0; H.264 HP LV 4.0; H.264 MVC (version 11)	1920x1080	60		
H.265	H.265 MP LV 4.1	1920x1080	60	50 M	8/9/10
	H.265 MP10 LV 4.1				
Generic	Motion JPEG	1920x1080	60	25 M	8
WMV	Window Media Video v9				
VC1	VC-1 (SP/MP/AP)				
VP9	VP9(profile-2 10bit)				50 M
RM	RV 8 (rv30)	1920x1080	30	25 M	8
	RV 9 (rv40)				
	RV 10 (rv40)				
AVS	AVS Jizhun Profile LV 6.0				
	AVS Plus				

2.Audio

PN	Audio Decoder (For MM Video)
PCM	wav: PCM / ADPCM / A-law PCM / u-law PCM ADPCM IMA4
AMR	AMR-NB, AMR-WB/AMR-WB+
LPCM	DVD LPCM
RA	cook: COOK (RealAudio6)
MPEG 1/2/4	MPEG1 Layer1/2
	MPEG1 Layer1/2 (MPEG2)
	MP3 (MPEG1 Layer3)
AAC	MPEG2 AAC (AAC-LC)
	MPEG4 AAC-LC, HE-AAC v1/v2
	raac: MPEG4 AAC-LC (RealAudio9)
	racp: MPEG4 HE-AAC v2 (RealAudio10)
WMA	WMA v7 , v8, v9, Pro
Dolby AC3 (DD)	Dolby Digital EX, Dolby Digital Plus
Dolby EAC3 (DDCO)	Dolby Digital Plus
Dolby TrueHD	Dolby lossless
Dolby MS11	No-HEAAC
FLAC	FLAC
VORBIS	VORBIS

3. Video / Audio Container

Container	File extension
TS	.ts, .tsv, .tsa
M2TS	.m2ts
MP4	.mp4, .m4a, .m4p, .m4b, .m4r
3GP	.3gp
MKV, MKAs	.mkv, .mk3d, .mka, .mks
FLV	.flv, .f4v, .f4p, .f4a, .f4b
ASF, WMV, WMA	.wmv, .wma
RM, RMVB	.rm, .rmvb
AVI	.avi
MPG, MPEG	.dat, .vob, .mpg, .mpeg, .m4a
OGG	.ogg, .ogv, .oga, .ogx, .ogm, .spx, .opus
MP3	.mp3
WAV	.wav, .wave
APE	.ape
AIFF	.aiff, .aif, .aifc

4. Image Decoder

File Extension	Container	Data Type
.jpg	JPEG	baseline
		progressive
.bmp	BMP	
.png	PNG	
.gif	GIF	static
		animation

Troubleshooting

Before requesting service or assistance, please follow these simple guides to resolve the problem.

If an error message appears, follow the message's instructions.

If the problem still persists, please contact your local Panasonic dealer for assistance.

Screen

Red, blue, green or black spots on the screen.

→ This is the characteristic of liquid crystal panels. The liquid crystal panel is built with very high precision technology. Occasionally, a few non-active pixels may appear on the screen as points of red, green, blue or black. This does not affect the performance of your TV and it is not a quality problem.

Chaotic image, noisy.

- Set [Noise reduction] in the [Picture] menu to remove noise (p. 13).
- Check nearby electrical products (car, motorcycle, fluorescent lamp).

No image is displayed.

- Check the settings of [Contrast] or [Brightness] in the [Picture] menu (p. 13).
- Check the TV is in AV mode. If the TV is in AV mode, check the selected input mode match the output of the external equipment (p. 10).

Unusual image is displayed.

- Turn the TV off with Mains power On / Off switch (p. 10), then turn it on again.

Pictures from equipment connected via HDMI are unusual.

- Check the HDMI cable is connected properly.
- Turn the TV and equipment off, then turn them on again.
- Check an input signal from the equipment (p. 18).
- Use equipment compliant with EIA/CEA-861/861D.

Sound

No sound is produced.

- Check the sound mute setting (p. 9) and volume.

Low level or distorted sound.

- Sound signal reception may be deteriorated.

Sound output via HDMI connection is unusual.

- Set the sound setting of the connected equipment to "2ch L.PCM".

General

The TV goes into Standby mode.

- This TV is equipped with auto power standby function (p. 18).

The remote control does not work or is intermittent.

- Replace the batteries (p. 5).
- Point the remote control directly at the remote control signal receiver of the TV (within about 7 m and 30 degree angle).
- Situate the TV away from sunshine or block sources of bright light from shining on the remote control signal receiver of the TV.

Parts of the TV become hot.

- Even if the temperature of parts of the front, top and rear panels has risen, these temperature rises do not cause any problems in terms of performance or quality.

The TV panel moves slightly when it is pushed with a finger.

Clattered sound might be heard.

- There is some flexibility around the panel to prevent damage. This is not a malfunction.

Overcurrent error message appears.

- The connected USB device might cause this error. Remove the device and turn the TV off with Mains power On / Off switch, then turn it on again.
- Check foreign objects are not inside the USB port.

Maintenance

First, remove the mains plug from the socket outlet.

Regular care

- Gently wipe the surface of the display panel, cabinet and pedestal by using a soft cloth.
- Wipe the mains plug with a dry cloth at regular intervals. Moisture and dust may lead to fire or electrical shock.

For stubborn dirt

First clean the dust on the surface. Dampen a soft cloth with clean water or diluted neutral detergent (1 part detergent to 100 parts water). Wring the cloth and wipe the surface. Finally, wipe away all the moisture.

Caution

- Do not use a hard cloth or rub the surface too hard as this could scratch the surface.
- Do not subject the TV's surfaces to water or detergent. Liquid inside the TV could lead to product failure.
- Do not subject the surfaces to insect repellent, solvent, thinner or other volatile substances. This may degrade surface quality or cause peeling of the paint.
- The surface of the display panel is specially treated and may be easily damaged. Take care not to tap or scratch the surface with your fingernail or other hard objects.
- Do not allow the cabinet and pedestal to make contact with a rubber or PVC substance for a long time. This may degrade surface quality.

Specifications

Model no.

32-inch model
TH-32JS610Z

43-inch model
TH-43JS610Z

Power source

AC 100 - 240 V, 50/60 Hz

Power consumption (Rated power / Standby power)

32-inch model
55 W / 0.5W

43-inch model
75 W / 0.5W

Display panel

Panel

LCD panel (LED backlight)

Visible screen size (diagonal)

32-inch model: 80 cm

43-inch model: 108 cm

Display resolution

32-inch model: 1366 (W) × 768 (H)

43-inch model: 1920 (W) × 1080 (H)

Dimensions (W × H × D)

32-inch model
725.9 x 475.6 x 178 mm (With Pedestal)
725.9 x 427.5 x 81.7 mm (TV only)

43-inch model
966.8 x 611.1 x 214.5 mm (With Pedestal)
966.8 x 566.4 x 88.5 mm (TV only)

Mass

32-inch model
3.9 kg (With Pedestal)
3.8 kg (TV only)

43-inch model
6.4 kg (With Pedestal)
6.3 kg (TV only)

Connection terminals

AV in

Mini, 1.0 V[p-p] (75 Ω)

EARPHONE

Mini, 130mV rms~ 150mV rms

HDMI 1 / 2 / 3 input

TYPE A Connectors

USB

USB 2.0 TYPE A Connectors

DC 5 V, Max. 500 mA

Speaker Output

32-inch model

Audio output

10 W (5 W + 5 W)

43-inch model

Audio output

16 W (8 W + 8 W)

Receiving systems / Band name

9 Systems

Systems	Function
1 PAL B, G	
2 PAL I	
3 PAL D, K	Reception of broadcast
4 NTSC 4.43	
5 NTSC 3.58	Playback from Special VCR's or DVD
6 PAL	
7 PAL 60 Hz/5.5 MHz	Playback from Special Disc Players and Special VCR's or DVD
8 PAL 60 Hz/6.0 MHz	
9 PAL 60 Hz/6.5 MHz	

Aerial input

VHF / UHF

Operating conditions

Temperature

0 °C - 40 °C

Humidity

20 % - 80 % RH (non-condensing)

Note

- Design and Specifications are subject to change without notice. Mass and Dimensions shown are approximate.

Receiving channels (Analogue TV)

VHF BAND

2-12 (PAL)

0-12 (PAL B AUST.)

1-9 (PAL B N.Z.)

1-12 (PAL)

UHF BAND

21-69 (PAL G, H, I)

28-69 (PAL B AUST.)

13-57 (PAL D, K)

Digital TV

DVB-T/T2 Standard

DVB-S/S2 Standard

Oss License

This product incorporates the following software:

- (1) The software developed independently by or for Panasonic Corporation,
- (2) The software owned by third party and licensed to Panasonic Corporation,
- (3) The software licensed under the GNU General Public License, Version 2.0 (GPL V2.0),
- (4) The software licensed under the GNU LESSER General Public License, Version 2.1 (LGPL V2.1), and/or
- (5) Open source software other than the software licensed under the GPL V2.0 and/or LGPL V2.1.

The software categorized as (3) - (5) are distributed in the hope that it will be useful, but WITHOUT ANY WARRANTY, without even the implied warranty of MERCHANTABILITY or FITNESS FOR A PARTICULAR PURPOSE. Please refer to the detailed terms and conditions thereof 【 [Settings] > [Device Preferences] > [About] > [Legal information] 】

At least three (3) years from delivery of this product, Panasonic will give to any third party who contacts us at the contact information provided below, for a charge no more than our cost of physically performing source code distribution, a complete machine-readable copy of the corresponding source code covered under GPL V2.0, LGPL V2.1 or the other licenses with the obligation to do so, as well as the respective copyright notice thereof.

Contact Information: osd-cd-request@gg.jp.panasonic.com

WARRANTY - New Zealand only

WE WARRANT that the Panasonic Television that you have purchased is free from defects in material and workmanship under normal home use and service.

Accordingly, we undertake to repair, or at our option, replace without cost to the owner, either for material or labour, any part which within 12 months from the date of delivery is found to be defective, provided that the appliance has been used for domestic purposes only and in accordance with the instructions given in the Instruction Book and not been subjected to misuse, neglect or installed, dismantled, repaired or serviced by any other than an authorised Panasonic New Zealand Dealer or Panasonic New Zealand Authorised Service Centre.

NOTE

- Before reporting a fault, please ensure that you read the item "Troubleshooting" in the information section of your Panasonic Instruction Book.
- It is important to retain your proof of purchase as this will be required by the serviceman or retailer as proof of purchase date, should service be required.
- In the event of service being required, contact your Panasonic New Zealand retailer or Panasonic New Zealand Authorised Service Centre.

IMPORTANT

Any request for warranty service must be through an Authorised Panasonic New Zealand Service Centre who during the period of the warranty, undertakes to make any necessary adjustment and fit any replacement part supplied by the manufacturer, during normal working hours, or alternatively will arrange for such service to be provided by some other Panasonic New Zealand Authorised Service Centre.

NEW ZEALAND

Distributed in New Zealand by Panasonic New Zealand Limited

18 Sir Woolf Fisher Drive, Highbrook, East Tamaki, Private Bag 14911, Panmure, Auckland

Tel. 09 272 0100

Customer Care Center

Email: Customerservice@nz.panasonic.com

www.panasonic.co.nz

Information on Disposal in other Countries outside the European Union



This symbol is only valid in the European Union. If you wish to discard this product, please contact your local authorities or dealer and ask for the correct method of disposal.

Customer's Record

The model number and serial number of this product may be found on its rear panel. You should note this serial number in the space provided below and retain this book, plus your purchase receipt, as a permanent record of your purchase to aid in identification in the event of theft or loss, and for Warranty Service purposes.

Model Number _____

Serial Number _____

Panasonic Corporation

Web Site: <http://www.panasonic.com>