

Operating Instructions LED TV

24-inch model



English

Thank you for purchasing this Panasonic product.
Please read these instructions carefully before operating
this product and retain them for future reference.

The images shown in this manual are for illustrative
purposes only.
Some illustrations are presented as conceptual images
and may be different from the actual products.
Illustrations shown may be different between models
and countries.

**The illustrations for 24-inch model is used in this
manual unless otherwise mentioned.**

Transport only in upright position

Important Notice

Panasonic does not guarantee operation and performance of peripheral devices made by other manufacturers; and we disclaim any liability or damage arising from operation and/or performance from usage of such other maker's peripheral devices.

Handling of customer information

The recording and playback of content on this or any other device may require permission from the owner of the copyright or other such rights in that content. Panasonic has no authority to and does not grant you that permission and explicitly disclaims any right, ability or intention to obtain such permission on your behalf. It is your responsibility to ensure that your use of this or any other device complies with applicable copyright legislation in your country. Please refer to that legislation for more information on the relevant laws and regulations involved or contact the owner of the rights in the content you wish to record or playback.

This product is licensed under the AVC patent portfolio license for the personal and non-commercial use of a consumer to (i) encode video in compliance with the AVC Standard ("AVC Video") and/or (ii) decode AVC Video that was encoded by a consumer engaged in a personal and non-commercial activity and/or was obtained from a video provider licensed to provide AVC Video. No license is granted or shall be implied for any other use.

Additional information may be obtained from MPEG LA, LLC.

See <http://www.mpegla.com>.

Panasonic and its affiliates make no representations or warranties of any kind with respect to the USB devices and the performance of communication between the USB devices and the USB port of Panasonic products, and expressly disclaims any and all warranties, whether express or implied or otherwise, including without limitation any implied warranty of fitness for a particular purpose, any loss of data, and any implied warranties arising from course of dealing or course of performance of data communication between the USB devices and the USB port of Panasonic products.

Transport only in upright position.



This mark indicates the product operates on AC voltage.



This mark indicates a Class II or double insulated electrical appliance wherein the product does not require a safety connection to electrical earth (ground).

Contents

Safety Precautions	3
Setting Up the TV	4
Connecting the TV	6
Initial Setup	8
Operating the TV	9
Watching External Inputs	10
Using Media Player	11
Using the Menu Functions	13
Additional Information	18
Troubleshooting	22
Maintenance	23
Specifications	24

Safety Precautions

To help avoid risk of electrical shock, fire, damage or injury, please follow the warnings and cautions below:

Mains plug and lead

Warning

If you detect anything unusual, immediately remove the mains plug.

- Mains plug types vary between countries.

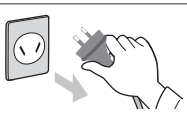

- This TV is designed to operate on AC 100 - 240 V, 50/60 Hz.
- Insert the mains plug fully into the socket outlet.
- Ensure that the mains plug is easily accessible.
- Disconnect the mains plug when cleaning the TV.
- Do not touch the mains plug with wet hands.



- Do not damage the mains lead.
 - Do not place a heavy object on the lead.



- Do not place the lead near a high temperature object.



- Do not pull on the lead. Hold onto the mains plug body when disconnecting the plug.



- Do not move the TV with the lead plugged into a socket outlet.
- Do not twist the lead, bend it excessively or stretch it.
- Do not use a damaged mains plug or socket outlet.
- Ensure the TV does not crush the mains lead.
- Do not use any mains lead other than that provided with this TV.

Take care

Warning

- Do not remove covers and never modify the TV yourself as live parts are accessible when they are removed. There are no user serviceable parts inside.
- Do not expose the TV to rain or excessive moisture. This TV must not be exposed to dripping or splashing water and objects filled with liquid, such as vases, must not be placed on top of or above the TV.



- Do not insert foreign objects into the TV through the air vents.
- Do not use an unapproved pedestal / mounting equipment. Be sure to ask your local Panasonic dealer to perform the setup or installation of approved wall-hanging brackets.
- Do not apply strong force or impact to the display panel.
- Do not place the TV on sloped or unstable surfaces, and ensure that the TV does not hang over the edge of the base.



- This TV is designed for table-top use.
- Do not expose the TV to direct sunlight and other sources of heat.



To prevent the spread of fire, keep candles or other open flames away from this product at all times



Dangerous part / Small object

Warning

- This product contains possibly dangerous parts such as plastic bags, that can be breathed in or swallowed by young children accidentally. Keep these parts out of reach of young children.

Pedestal

Warning

- Do not disassemble or modify the pedestal.

Caution

- Do not use any pedestal other than the one provided with this TV.
- Do not use the pedestal if it becomes warped or physically damaged. If this occurs, contact your nearest Panasonic dealer immediately.
- During setup, make sure that all screws are securely tightened.
- Ensure that the TV does not suffer any impact during installation of the pedestal.
- Ensure that children do not climb onto the pedestal.
- Install or remove the TV from the pedestal with at least two people.
- Install or remove the TV by the specified procedure.

Ventilation

Caution

Allow sufficient space around the TV in order to help prevent excessive heat, which could lead to early failure of some electronic components.

Minimum distance (cm)

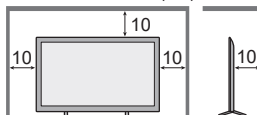

- Ventilation should not be impeded by covering the ventilation openings with items such as newspapers, tablecloths and curtains.



- Whether you are using a pedestal or not, always ensure the vents at the bottom of the TV are not blocked and there is sufficient space to enable adequate ventilation.

■ Moving the TV

Caution

Before moving the TV, disconnect all cables.

- Move the TV with at least two people. Support as shown to avoid injury by the TV tipping or falling.

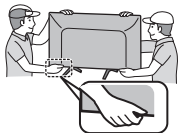

■ When not in use for a long time

Caution

This TV will still consume some power even in the Off mode, as long as the mains plug is still connected to a live socket outlet.

- Remove the mains plug from the wall socket when the TV is not in use for a prolonged period of time.

■ Use conditions

Caution

- This appliance is intended for use in tropical climates.

■ Battery for the Remote Control

Caution

- Incorrect installation may cause battery leakage, corrosion and explosion.
- Replace only with the same or equivalent type.
- Do not mix old and new batteries.
- Do not mix different battery types (such as alkaline and manganese batteries).
- Do not use rechargeable batteries (Ni-Cd, etc.).
- Do not burn or break up batteries.
- Do not expose batteries to excessive heat such as sunshine, fire or the like.
- Make sure you dispose of batteries correctly.

■ Prevention of Dumping

Caution

- Please use the screw in the wall-mount hole of the back cover with the restraining bracket and rope to make sure that it is firmly tied and fixed on the table and other solid position .

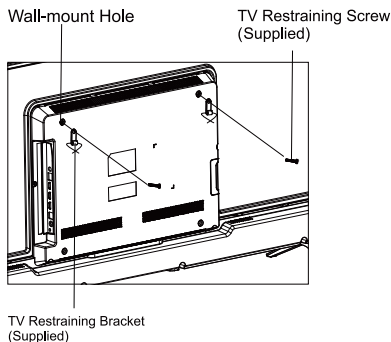

Setting Up the TV

Supplied accessories

Accessories may not be placed all together. Take care not to throw them away unintentionally.

Operating Instructions

Remote Control

- RC818PT



Batteries (AA) × 2

- ➔ (p.5)



Pedestal

24-inch model

- Base

- Assembly screws

A  (ST3 × 12) × 4



Attaching the pedestal

1 Assemble the pedestal

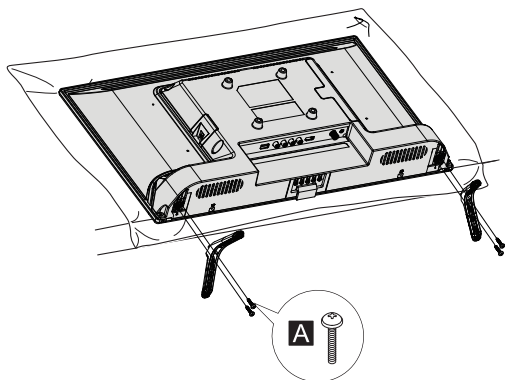

Removing the pedestal from the TV

Be sure to remove the pedestal in the following way when using the wall-hanging bracket or repacking the TV.

1 Lay the TV on a foam mat or thick soft cloth on a table.

2 Remove the assembly screws **A** from the TV.

Inserting remote's batteries

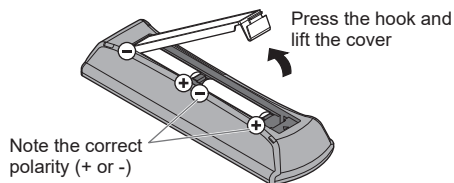

Wall mounting the TV (optional)

Please contact your local Panasonic dealer to purchase the recommended wall-hanging bracket.

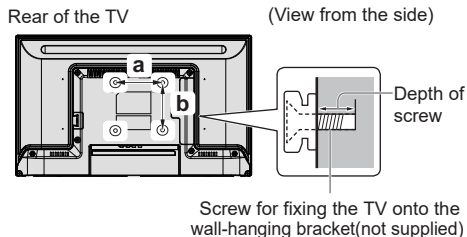

Screw for fixing the TV onto the wall-hanging bracket(not supplied)

Holes for wall-hanging bracket installation

Model	a	b
24-inch	100 mm	100 mm

Screw specification

Model	Type	Depth of screw	
		Minimum	Maximum
24-inch	M4	8 mm	8 mm

Warning

- When optional accessories such as wall brackets etc. are used, always read and follow the manufacturer installation and usage instructions.
- Do not mount the unit directly below ceiling lights (such as spotlights or halogen lights) which typically give off high heat. Doing so may warp or damage plastic cabinet parts.
- When installing wall brackets you must ensure the wall bracket is not electrically grounded to metal wall studs. Always ensure that there are no electrical cables, pipes etc. in the wall before you begin the wall bracket installation.
- To prevent fall and injury, remove the TV from its fixed wall position when it is no longer in use.

Connecting the TV

- Please ensure the TV is disconnected from the mains socket/ power point before attaching or disconnecting any RF/ AV leads.
- External equipment and cables are for illustrative purposes only and not supplied with this TV.
- Check the type of terminals and cable plugs are correct when connecting.
- When using an HDMI cable, use the fully wired one.
- Keep the TV away from electronic equipment (video equipment, etc.) or equipment with an infrared sensor. Otherwise, distortion of image/ sound may occur or operation of other equipment may be interfered.
- Also read the manual of the equipment being connected.

Connecting the TV

Terminals

Rear of the TV

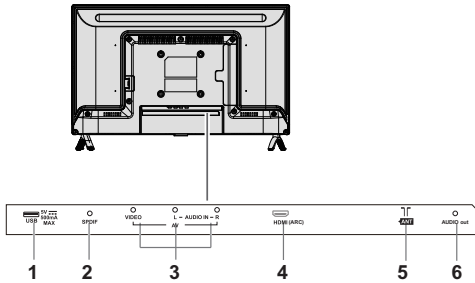

- 1 **USB**
- 2 **SPDIF**
- 3 **AV**
- 4 **HDMI(ARC)**
- 5 **ANTENNA in**
- 6 **AUDIO out**

Connections

Aerial

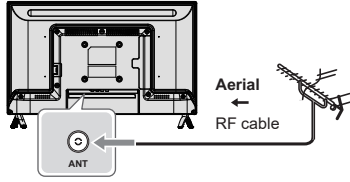

- Keep RF (aerial) cable away from the mains lead to avoid and minimise mains interference pickup.
- Do not place the RF cable under the TV.
- An aerial, correct cable (75 Ω coaxial) and correct terminating plug are required to obtain optimum quality picture and sound.
- If a communal aerial system is used, you may require the correct connection cable and plug between the wall aerial socket and the TV.
- Your local Television Service Centre or dealer may be able to assist you in obtaining the correct aerial system for your particular area and the accessories required.
- Any matters regarding aerial installation, upgrading of existing systems or accessories required, and the costs incurred, are the responsibility of you, the customer.
- If the aerial is placed in the wrong location, interference might happen.

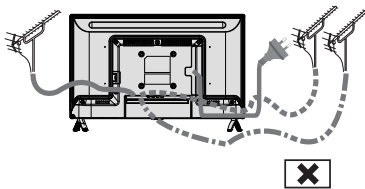
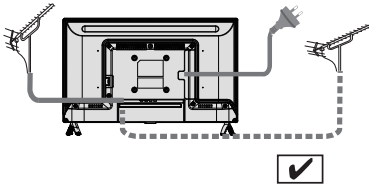

AV / Game equipment

Using HDMI terminal

TV

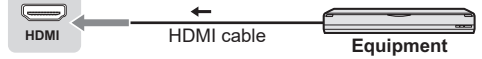

Using AV terminals

TV

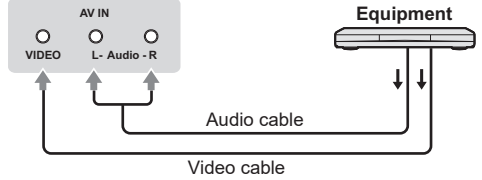

Speaker system

TV

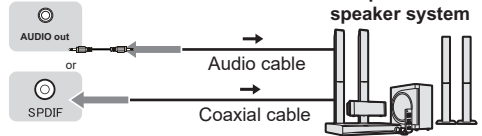

- To enjoy the sound from the external equipment in multi-channel sound (e.g. Dolby Digital 5.1ch), connect the equipment to the amplifier. For the connections, read the manuals of the equipment and amplifier.

Initial Setup

When you first turn on the TV, a series of steps will pop-up to guide you to setup your TV.

- These steps are not necessary if the setup has been completed by your local dealer.

1 Plug the mains plug into the socket outlet and turn on the TV.

It may take a few seconds before the screen is displayed.

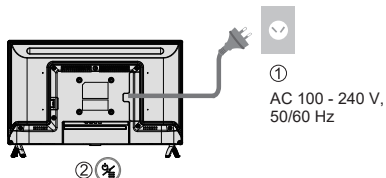

2 Select your language.



3 Select [Home].



- [Shop] is for shop display.

Setup is now complete and your TV is ready for viewing.

4 Select your country.



5 Select channel type.



6 Scanning starts.

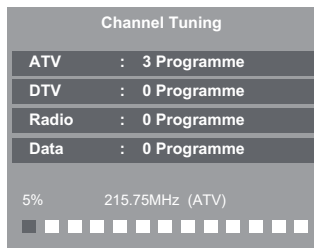

- This function searches and stores TV channels.
- The stored channels and sorted channel order vary depending on the area, broadcasting system and conditions of signal reception.

Note

- If tuning has failed, check the connection of the RF cable, then follow the on-screen instructions.

Operating the TV

Using the remote control

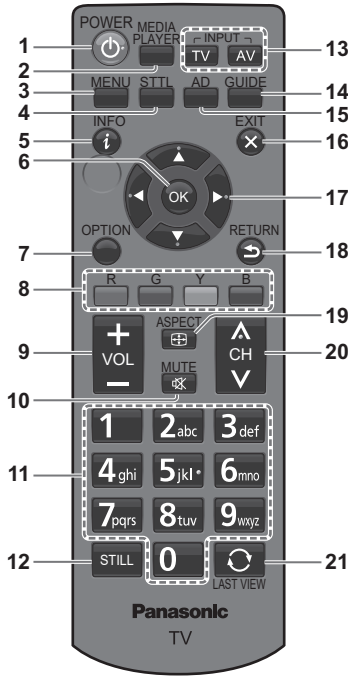

- 1** Switches the TV On / Standby
- 2** MEDIA PLAYER ➔ (p. 11)
- 3** Displays [Main Menu] ➔ (p. 13)
- 4** Displays subtitles
- 5** Displays Information banner
- 6** OK
 - Confirms selections.
 - Press after selecting channel positions to quickly change channel.
 - Displays the [Channel List].
- 7** Displays [Option Menu]
 - Quick to access Picture preset and Sound preset.
 - Follow the operation guide to select / change the settings.
- 8** Colored buttons
 - Performs multiple operations which correspond to the operation guide displayed on the menu screen.
- 9** Volume Up / Down
- 10** Sound Mute On / Off
- 11** Numeric buttons
 - Changes channel.
 - Sets characters.
- 12** Freezes / unfreezes picture

13 Input mode selection

- TV - switches to TV input mode.
- AV - displays [Input Selection] screen (p. 11).

14 TV Guide ➔ (p. 10)

15 AD switch

16 Exits to the TV viewing screen

17 Cursor buttons

- Makes selections or adjustments.

18 Returns to the previous menu / page

19 ASPECT

- Displays the [Aspect Selection] screen. Follow the operation guide to select the mode. [4:3] / [16:9] / [Zoom1] / [Zoom2] / [Auto]. ➔ (p. 18)

20 Channel Up / Down

21 Returns to the last viewed channel

[Color Buttons]

Lists out channels based on Analogue / Digital

R
In Programme Edit, delete channels. Or delete file in Media Player.

G
In Programme Edit, rename channels. (only appear in ATV source)

Y
In Programme Edit, move channels. (only appear in DTV source)

B
In Programme Edit, skip channels. Displays the Audio Language menu for selection of audio tracks. (appear in DTV source)

In Programme Edit, skip channels.

Change audio type between stereo and mono while watching program (appear in ATV source)

When using the TV Guide, color buttons can also work as the menu displayed.

About operation guide

When operating the TV with the remote control, follow the operation guide available at the bottom of the screen to perform the operation you want.

Referring to the operation guide:

- To select the mode
- To change to the selected mode



- To return to the previous menu



- To exit from the menu



Using the TV controls

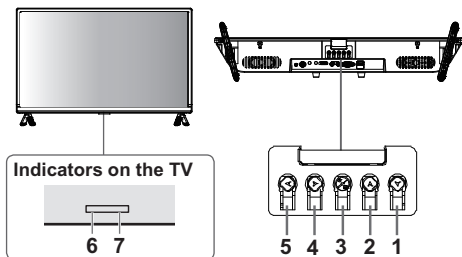

1 Channel Up Cursor Up

- Makes selections in the menu system.

2 Channel Down Cursor Down

- Makes selections in the menu system.

3 Displays [Menu] / Source Select / Mains power On / Off switch

- Turns the TV on or standby.
- The TV is on, press it, bring up the main menu or confirm selections in submenu.
- Before enter menu, long press it for 3 seconds to display Source Select. Long press it for 5 seconds to go to Standby.

4 Volume Up Cursor Right

- Makes selections and / or adjustments when in the menu system.

5 Volume Down Cursor Left

- Makes selections and / or adjustments when in the menu.

6 Power LED

- Red: Standby
- Green: On

7 Remote control signal receiver

Using TV Guide

The TV Guide - Electronic Programme Guide (EPG), shows a list of broadcasts for several days (depending on the broadcasters).

- When this TV is turned on for the first time, or switched off for more than a week, it may take some time before the TV Guide is completely shown.
- This function varies depending on the country.
- Channels are displayed on the same TV Guide screen. There will be no programme listings for Analogue channels.
- DTV mode only.

Display the TV Guide.

GUIDE



Example:

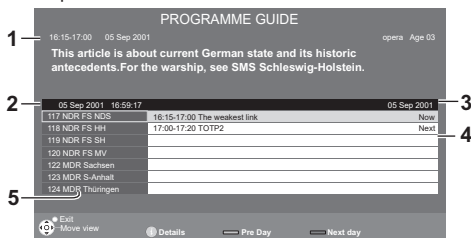

1 TV Guide date and time

2 Current date and time

3 TV Guide time

4 Programme

5 Channel position and name

Follow the operation guide to operate the TV Guide.

Note

- It may be slow to response when pressing the **UP / DOWN / LEFT / RIGHT** cursor button for TV program guide. This is due to program data downloading.

Watching External Inputs

1 Connect the external equipment.

➔ (p. 6 - 7)

2 Display the [Input Source] menu, then select the input of the connected equipment.

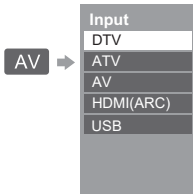

Press OK to access.



Note

If the external equipment has an aspect adjustment function, set it to "16:9".

Using Media Player

Media Player allows you to enjoy photo, music or video recorded on a USB Flash Memory.

- The picture may not appear correctly on this TV depending on the digital cameras used.
- Display may take some time when there are many files and folders in the USB Flash Memory.
- Partly degraded files might be displayed at a reduced resolution.
- The folder and file names may be different depending on the digital camera used.

Inserting / Removing the USB Flash Memory

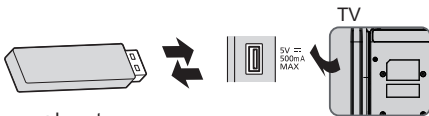

- Insert or remove straight and completely.

Starting Media Player

1 Insert the USB Flash Memory.

2 Select the mode.



[PHOTO]: Displays the thumbnail of all photos in the USB Flash Memory.

[MOVIE]: Displays the thumbnail of video titles in the USB Flash Memory.

[MUSIC]: Displays the thumbnail of music folders in the USB Flash Memory.

[Contents Display]

Follow the operation guide to perform available operations.

When the cursor stays on the icon, it displays the information of the highlighted content.

Photo mode



Operation guide

[Play Folder]

To play the selected file

Plays all photo in the selected folder.

Select the folder.



Select the file.



[Menu]

[Photo show Settings]

- ▶/|| Play or pause the showing.
- ◀ Play previous photo.
- ▶ Play Next photo.
- Stop photo show.
- ↺ Slideshow repeat. [Repeat 1] / [Repeat All] / [Repeat None].
- 🎵 Background music during photo viewing.
- ☰ Show all the photo list.
- ⓘ Show the details of the chosen photo.
- ↻/↺ Rotate the direction of photo in the direction of arrow.
- 🔍 Zoom in the photo.
- 🔍 Zoom out the photo.
- ↻ Adjust the position when zoom in.

Note

- Picture quality may become lower depending on the slideshow settings.

MOVIE mode

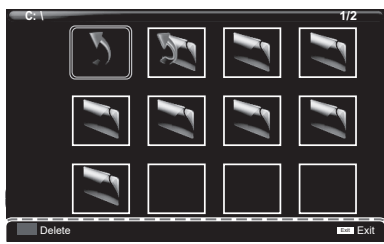

Operation guide

MUSIC mode

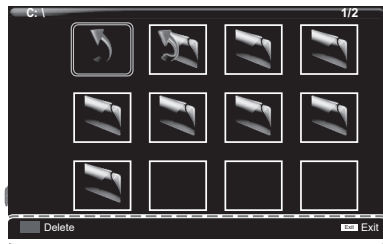

Operation guide

[Play Folder]

Plays all movies in the selected folder.

■ To playback the selected file only

Select the folder.



Select the file.



[Option Menu]

■ [Movie Setup Menu]

- ▶/|| Play or pause the playing.
- ◀ Fast backward.
- ▶ Fast forward.
- ◀ Play previous video.
- ▶ Play Next video.
- Stop video show.
- Aa Choose Charset .
- ↺ Repeat mode.
[Repeat 1] / [Repeat All] / [Repeat None].
- ⌚ Set the repeat time from A to B.
- ☰ Show all the video list.
- i Show the details of the choosen file.
- ▶ Play the video in slow speed.
- ▢ Play the video by frames.
- ⌚ Set the time point to play.
- 🔍 Zoom in the viewing.
- 🔍 Zoom out the viewing.
- ⚙ Adjust the ratio.
- 📍 Adjust the positon when zoom in.

[Play Folder]

Plays all music in the selected folder.

■ To playback the selected file only

Select the folder.



Select the file.



[Option Menu]

■ [Music Setup Menu]

- ▶/|| Play or pause the playing.
- ◀ Fast backward.
- ▶ Fast forward.
- ◀ Play previous music.
- ▶ Play Next music.
- Stop music playing.
- ↺ Repeat mode.
[Repeat 1] / [Repeat All] / [Repeat None].
- 🔇 Mute.
- ☰ Show all the music list.
- i Show the details of the choosen file.
- ⌚ Set the time point to play.

Using the Menu Functions

1 Display the menu.



Example:

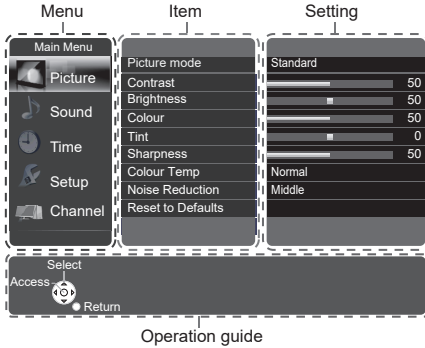

2 Select the menu.



3 Select the item.

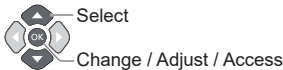

4 Change the setting.

Example:

- Adjust the intensity bar



- Change the setting option

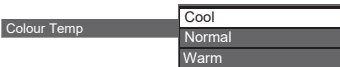

Note

- Only available items can be selected.

Picture

[Picture Mode]

Sets the picture mode for each input. **[Dynamic]** / **[Standard]** / **[Mild]** / **[Personal]**

[Dynamic]: Improves contrast and sharpness for viewing in a bright room.

[Standard]: For viewing in a normal lighting condition.

[Mild]: For viewing in a soft way for eyes.

[Personal]: adjust the picture according to your preference.

Setting for picture mode **[Contrast]**, **[Brightness]**, **[Colour]**, **[Sharpness]** only can adjust in Personalmode. Setting for tint cannot be adjusted in any picture mode.

[Contrast], [Brightness], [Colour], [Tint], [Sharpness]

Increases or decreases the levels of these options according to your personal preference.

These options only available in Personal mode.

Tint only available in NTSC signal.

[Colour Temp]

Selects the colour temperature of the picture.

[Cool] / **[Normal]** / **[Warm]**

[Noise reduction]

Reduces picture "static" or any type of interference.

This feature is especially useful for providing a clearer picture in weak analog signal conditions. **[Off]** / **[Low]** / **[Middle]** / **[High]**

[Reset to Defaults]

Resets the current picture settings to defaults.

Sound

[Sound Mode]

Select a sound type from the list. **[Standard]** / **[Music]** / **[Movie]** / **[Sports]** / **[Personal]**.

[Treble]

Adjusts level to enhance or minimise sharper, higher sound output. (Only available in Personal mode.)

[Bass]

Adjusts level to enhance or minimise lower, deeper sound output. (Only available in Personal mode.)

[Balance]

Adjusts volume level of right and left speakers.

[Auto Volume]

Select **[On]** mode to reduce the annoying blasts in volume during commercial breaks and also amplifies softer sounds in program material. Eliminates the need to constantly adjust the volume.

The options offered depend on the programme you are watching.

[AD Switch]

Audio Description Function. Choose on for visually impaired person.

[SPDIF mode]

Connect to an audio device through the SPDIF output. Select a proper sound type from the list for digital programmes. **[Off]** / **[Auto]** / **[PCM]**

[MPX]

Changes multiplex sound mode (if available).

[Reset to Defaults]

Resets the current sound settings to defaults.

Time

[Clock]

Auto synchronization the time, TV will get the time automatically from TV signals.

[Summer Time]

Camp time is set forward one hour.

[Auto] / **[On]** / **[Off]**

[Sleep Timer]

Sets the duration until the TV automatically goes to Standby mode.

[Off] / **[15 / 30 / 45 / 60 / 120 / 180 min]**

[Auto Standby]

Enables the TV to turn into Standby mode automatically if no operation is performed after the 4 hours.

- Automatic input switching with the connected equipment affects this function and time-count will be reset.

[Time Zone]

Adjusts the time data based on GMT.

[OSD Timer]

Sets the duration when main menu disappear if there is no operation.

[5 S] / **[15 S]** / **[30 S]**

Setup

[OSD Language]

Changes language for on-screen displays.

[English]]

[Audio Languages]

Set the primary language of audio language of current TV. [**Primary**] / [**Secondary**]

Default setting is English.

[Subtitle Language]

Set the primary language of subtitle language appear on the screen. [**Primary**] / [**Secondary**]

Default setting is English.

[Hearing Impaired]

Provides aids in understanding and enjoyment with Digital TV subtitles (depending on the broadcaster).

[Aspect Ratio]

Displays the [Aspect Ratio] screen. Follow the operation guide to select the mode. [**4:3**] / [**16:9**] / [**Zoom 1**] / [**Zoom 2**] / [**Auto**]

[Blue Screen]

If [on] selected, when there is no input, the background will be blue screen. (only available on some source)

[Lock]

You can lock specific channels. When the locked channel is selected, a message appears. Enter the Password to watch.

If Lock System is on, password will be needed when tuning.

Enter the number (4 digits).



- Make a note of the Password in case you forget it. (The initial password is 0000)

Set Password (4 digits).

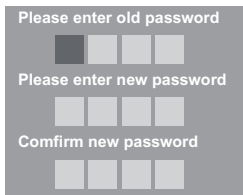

Block Program

1	BBC ONE	DTV
2	BBC TWO	DTV
3	BBC CHOICE	DTV
4	BBC NEWS	DTV

Choose channels you want to lock.

[Parental Rating]

This option allows you to set a rating to a programme.

[Reset]

Choose it to enter Initial Setup.

[HDMI CEC]

When set to [On], the TV will automatically switch to the appropriate HDMI input whenever an HDMI connected equipment is initially turned on and play mode is selected. [**Off**] / [**On**]

Note: When set to [On], the ARC can be used.

[Input]

Select input source of connected equipment.

Channel

Use the [Channel Menu] to retune the TV automatically or manually.

[Auto Tuning]

Automatically searches and adds available channels to the memory.

Example: DVB-T

Choose tune type.

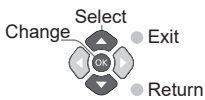
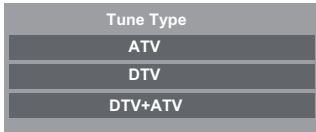

Choose your country.



Start tuning.

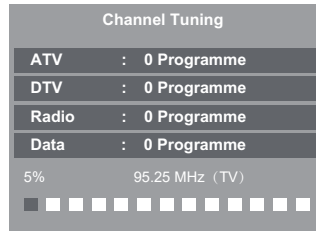

[DTV Manual Tuning]

Choose frequency to install channels. Press OK to search.

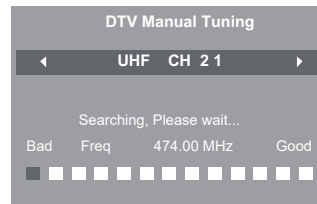

[ATV Manual Tuning]

Set correct options to install channels.

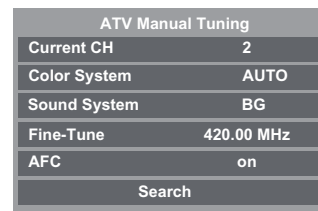

[Programme Edit]

Edits channel settings.

Use colour key to delete, rename, remove and skip programme.

R



In Programme Edit, delete channels.

G



In Programme Edit, rename channels.
(only appear in ATV source)

Y



In Programme Edit, move channels.
(only appear in DTV source)

B



In Programme Edit, skip channels.
Change audio type between stereo and mono while watching program

[Signal information]

Show signal information of the current channel.

(Only available in DTV source.)

Signal Information	
Channel:24 (562.00 MHz)	
Quality 100	(Good)
Strength 42	(Average)
Network	
Modulation	

Additional Information

Auto power standby function

The TV will automatically go into Standby mode in the following conditions:

- No signal is received and no operation is performed for 15 minutes in all signal source(except USB media).
- [Sleep timer] is active in the [Time] menu (p. 14).
- No operation is performed for the period selected in [Auto Standby] (p. 14).

Information banner

To display information banner (Digital TV)

INFO



(Press again to hide the banner.)

Example : Digital TV

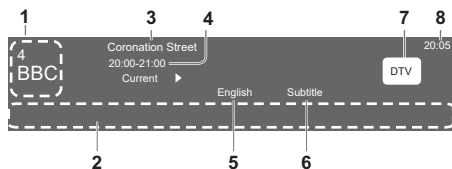

- 1 Channel number and name
- 2 Programme details
- 3 Programme name
- 4 Programme Start / Finish time (Digital TV)
- 5 Audio language (Choose Primary in [Setup])
- 6 Subtitle (If available)
- 7 Input signal
- 8 Current time

Aspect

■ [4:3]

Displays the image at the standard 4:3 without distortion.

■ [16:9]

Directly displays the image at 16:9 without distortion (anamorphic).

■ [Zoom1]

Displays the image with amplification that greater than original ratio.

■ [Zoom2]

Displays the image with amplification that greater than zoom1 ratio.

■ [Auto]

Displays the image based on the TS stream.

Input signal that can be displayed

Signal name	COMPONENT	HDMI
525 (480) / 60i, 60p		<input type="radio"/>
625 (576) / 50i, 50p		<input type="radio"/>
750 (720) / 60p, 50p		<input type="radio"/>
1,125 (1,080) / 60i, 50i		<input type="radio"/>
1,125 (1,080) / 60p, 50p		<input type="radio"/>

○ Mark : Applicable input signal

- Signals other than above may not be displayed properly.
- The above signals are reformatted for optimal viewing on your display.

Read Before Playing Photo, Video, or Music Files

Read this information before playing media content.

Limitations on use of photo, video, and music files

- The TV supports MSC(Mass Strong Class) USB devices only. MSC is a class designation for mass storage devices. Types of MSC devices include external hard drives, flash card readers, and digital cameras. (USB hubs are not supported.) These kinds of devices must be connected directly to the USB port. The TV may not be able to recognise a USB device or read the files on the device if it is connected with a USB extension cable. Do not disconnect USB devices while they are transferring files.
- When connecting an external hard drive, use the USB(HDD) port. We recommend that you use an external hard drive with its own power adapter.
- Certain digital cameras and audio devices may not be compatible with the TV.
- The TV supports the FAT and NTFS file systems.
- After sorting files in the Folder view mode, the TV can display up to 1,000 files per folder. If the USB device contains more than 8,000 files and folders, however, some files and folders might not be accessible.
- Certain files, depending on how they are encoded, may not play on the TV.
- Certain files are not supported on all models.
- DivX and DTS codecs are not supported by the Panasonic.

Supported file format in Media Player

Licenses involved in specifications following are supposed to be obtained by customers.

*Need the specific chip and Hash Key to support.

1.Video

P/N	Video Decoder	Resolution	Max fps	Maxbitrate (Mbps)	Bit depth
MPEG 1/2/4	MPEG1	1920x1080	30	40M	8
	MPEG2 MP@HL	1920x1080	30	40M	8
	MPEG-4 SP@HL 3.0	1920x1080	30	40M	8
	MPEG-4 ASP@HL 4.0	1920x1080	30	40M	8
Xvid*	XviD	1920x1080	30	40M	8
H.264	H.264 BP LV 4.0	1920x1080	60	50M	8
	H.264 MP LV 4.0	1920x1080	60	50M	8
	H.264 HP LV 4.0	1920x1080	60	50M	8
	H.264 MVC (version 11)	1920x1080	60	50M	8
H.265	H.265 Main profile @ Level 4.1	1920x1080	60	50M	8
	H.265 Main10 profile @ Level 4.1	1920x1080	60	50M	8/9/10
Generic*	Motion JPEG	640x480	30	10M	8
WMV	Window Media Video v9	1920x1080	30	40M	8
VC1	VC-1 (SP/MP/AP)	1920x1080	30	40M	8
RM*	RV 8 (rv30)	1920x1080	30	40M	8
	RV 9 (rv40)	1920x1080	30	40M	8
	RV 10 (rv40)	1920x1080	30	40M	8
AVS*	AVS Jizhun Profile LV 6.0	1920x1080	30	40M	8
	AVS Plus	1920x1080	30	40M	8
Sorenson*	Sorenson H.263	1920x1080	30	40M	8
Motion JPEG*	M-JPEG	1920x1080	30	40M	8
H.263*	H.263	1920x1080	30	40M	8

2. Audio

PN	Audio Decoder (For MM Video)
PCM	wav: PCM / ADPCM / A-law PCM / u-law PCM
	ADPCM IMA4
AMR	AMR-NB, AMR-WB/AMR-WB+
LPCM	DVD LPCM
RA	cook: COOK (RealAudio6)
MPEG 1/2/4	MPEG1 Layer1/2
	MPEG1 Layer1/2 (MPEG2)
	MP3 (MPEG1 Layer3)
AAC	MPEG2 AAC (AAC-LC)
	MPEG4 AAC-LC
	MPEG4 HE-AAC v1/v2
	raac: MPEG4 AAC-LC
	racp: MPEG4 HE-AAC v2 (RealAudio10)
WMA*	WMA v7
	WMA v8
	WMA v9
	WMA Pro
Dolby AC3 (DD)*	AC3
	Dolby Digital EX, Dolby Digital Plus
	dnet: AC3 (RealAudio3)
Dolby EAC3* (DDCO)	Dolby Digital Plus
	Dolby Digital Plus
Dolby TrueHD*	Dolby lossless
Dolby MS11	No-HEAAC
Dolby MS12 v1.3*	Config-D
FLAC	FLAC
	FLAC (96hz)
VORBIS	VORBIS

3. Video / Audio Container

Container	File extension
TS	.ts, .tsv, .tsa
MP4	.mp4, .m4a, .m4p, .m4b, .m4r
3GP	.3gp
MKV, MKA	.mkv, .mk3d, .mka, .mks
FLV*	.flv, .f4v, .f4p, .f4a, .f4b
ASF, WMV, WMA	.wmv, .wma
RM*, RMVB*	.rm, .rmvb
AVI	.avi
MPG, MPEG	.dat, .vob, .mpg, .mpeg, .m4a
OGG	.ogg, .ogv, .oga, .ogx, .ogm, .spx, .opus
MP3	.mp3
WAV	.wav, .wave

4. Image Decoder

File Extension	Container	Data Type
.jpg	JPEG	baseline
		progressive
.bmp	BMP	
.png	PNG	
.gif*	GIF	static
		animation

Troubleshooting

Before requesting service or assistance, please follow these simple guides to resolve the problem.

If an error message appears, follow the message's instructions.

If the problem still persists, please contact your local Panasonic dealer for assistance.

Screen

Red, blue, green or black spots on the screen.

→ This is the characteristic of liquid crystal panels. The liquid crystal panel is built with very high precision technology. Occasionally, a few non-active pixels may appear on the screen as points of red, green, blue or black. This does not affect the performance of your TV and it is not a quality problem.

Chaotic image, noisy.

- Set [Noise reduction] in the [Picture] menu to remove noise (p. 13).
- Check nearby electrical products (car, motorcycle, fluorescent lamp).

No image is displayed.

- Check the settings of [Contrast] or [Brightness] in the [Picture] menu (p. 13).
- Check the TV is in AV mode. If the TV is in AV mode, check the selected input mode match the output of the external equipment (p. 10).

Unusual image is displayed.

- Turn the TV off with Mains power On / Off switch (p. 10), then turn it on again.

Pictures from equipment connected via HDMI are unusual.

- Check the HDMI cable is connected properly.
- Turn the TV and equipment off, then turn them on again.
- Check an input signal from the equipment (p. 18).
- Use equipment compliant with EIA/CEA-861/861D.

Sound

No sound is produced.

- Check the sound mute setting (p. 9) and volume.

Low level or distorted sound.

- Sound signal reception may be deteriorated.

Sound output via HDMI connection is unusual.

- Set the sound setting of the connected equipment to "2ch L.PCM".

General

The TV goes into Standby mode.

- This TV is equipped with auto power standby function (p. 18).

The remote control does not work or is intermittent.

- Replace the batteries (p. 5).
- Point the remote control directly at the remote control signal receiver of the TV (within about 7 m and 30 degree angle).
- Situate the TV away from sunshine or block sources of bright light from shining on the remote control signal receiver of the TV.

Parts of the TV become hot.

- Even if the temperature of parts of the front, top and rear panels has risen, these temperature rises do not cause any problems in terms of performance or quality.

The TV panel moves slightly when it is pushed with a finger.

Clattered sound might be heard.

- There is some flexibility around the panel to prevent damage. This is not a malfunction.

Overcurrent error message appears.

- The connected USB device might cause this error. Remove the device and turn the TV off with Mains power On / Off switch, then turn it on again.
- Check foreign objects are not inside the USB port.

Maintenance

First, remove the mains plug from the socket outlet.

Regular care

- Gently wipe the surface of the display panel, cabinet and pedestal by using a soft cloth.
- Wipe the mains plug with a dry cloth at regular intervals. Moisture and dust may lead to fire or electrical shock.

For stubborn dirt

First clean the dust on the surface. Dampen a soft cloth with clean water or diluted neutral detergent (1 part detergent to 100 parts water). Wring the cloth and wipe the surface. Finally, wipe away all the moisture.

Caution

- Do not use a hard cloth or rub the surface too hard as this could scratch the surface.
- Do not subject the TV's surfaces to water or detergent. Liquid inside the TV could lead to product failure.
- Do not subject the surfaces to insect repellent, solvent, thinner or other volatile substances. This may degrade surface quality or cause peeling of the paint.
- The surface of the display panel is specially treated and may be easily damaged. Take care not to tap or scratch the surface with your fingernail or other hard objects.
- Do not allow the cabinet and pedestal to make contact with a rubber or PVC substance for a long time. This may degrade surface quality.

Specifications

Model no.

24-inch model
TH-24J400Z

Power source

AC 100 - 240 V, 50/60 Hz

Power consumption (Rated power / Standby power)

24-inch model
40 W / 0.5W

Display panel

Panel

LCD panel (LED backlight)

Visible screen size (diagonal)

24-inch model: 60 cm

Display resolution

24-inch model: 1,366 (W) × 768 (H)

Dimensions (W × H × D)

24-inch model

549.1 x 366.8 x 131.1 mm (With Pedestal)

549.1 x 327.6 x 87.1 mm (TV only)

Mass

24-inch model

2.6 kg (With Pedestal)

2.55 kg (TV only)

Connection terminals

AV IN (VIDEO)

VIDEO

1.0 V_[p-p] (75 Ω)

AUDIO L - R

0.5 V_[rms]

HDMI

TYPE A Connectors

USB

USB 2.0 TYPE A Connectors

DC 5 V, Max. 500 mA

AUDIO out

0.2~0.8V RMS (10K)

Speaker Output

Audio output

24-inch model

6 W (3 W + 3 W)

Receiving systems / Band name

9 Systems

Systems	Function
1 PAL B, G	
2 PAL I	
3 PAL D, K	Reception of broadcast
4 SECAM B, G	
5 SECAM D, K	
6 PAL	Playback from Special VCR's or DVD
7 PAL 60 Hz/5.5 MHz	Playback from Special
8 PAL 60 Hz/6.0 MHz	Disc Players and Special
9 PAL 60 Hz/6.5 MHz	VCR's or DVD

Aerial input

VHF / UHF

Operating conditions

Temperature

0 °C - 45 °C

Humidity

20 % - 80 % RH (non-condensing)

Note

- Design and Specifications are subject to change without notice. Mass and Dimensions shown are approximate.

Receiving channels (Analogue TV)

VHF BAND

2-12 (PAL/SECAM B, K1)

0-12 (PAL B AUST.)

1-9 (PAL B N.Z.)

1-12 (PAL/SECAM D)

UHF BAND

21-69 (PAL G, H, I/SECAM G, K, K1)

28-69 (PAL B AUST.)

13-57 (PAL D, K)

WARRANTY - New Zealand only

WE WARRANT that the Panasonic Television that you have purchased is free from defects in material and workmanship under normal home use and service.

Accordingly, we undertake to repair, or at our option, replace without cost to the owner, either for material or labour, any part which within 12 months from the date of delivery is found to be defective, provided that the appliance has been used for domestic purposes only and in accordance with the instructions given in the Instruction Book and not been subjected to misuse, neglect or installed, dismantled, repaired or serviced by any other than an authorised Panasonic New Zealand Dealer or Panasonic New Zealand Authorised Service Centre.

NOTE

- Before reporting a fault, please ensure that you read the item "Troubleshooting" in the information section of your Panasonic Instruction Book.
- It is important to retain your proof of purchase as this will be required by the serviceman or retailer as proof of purchase date, should service be required.
- In the event of service being required, contact your Panasonic New Zealand retailer or Panasonic New Zealand Authorised Service Centre.

IMPORTANT

Any request for warranty service must be through an Authorised Panasonic New Zealand Service Centre who during the period of the warranty, undertakes to make any necessary adjustment and fit any replacement part supplied by the manufacturer, during normal working hours, or alternatively will arrange for such service to be provided by some other Panasonic New Zealand Authorised Service Centre.

NEW ZEALAND

Distributed in New Zealand by Panasonic New Zealand Limited

18 Sir Woolf Fisher Drive, Highbrook, East Tamaki, Private Bag 14911, Panmure, Auckland

Tel. 09 272 0100

Customer Care Center

Email: Customerservice@nz.panasonic.com

www.panasonic.co.nz

Information on Disposal in other Countries outside the European Union



This symbol is only valid in the European Union. If you wish to discard this product, please contact your local authorities or dealer and ask for the correct method of disposal.

Customer's Record

The model number and serial number of this product may be found on its rear panel. You should note this serial number in the space provided below and retain this book, plus your purchase receipt, as a permanent record of your purchase to aid in identification in the event of theft or loss, and for Warranty Service purposes.

Model Number _____

Serial Number _____

Panasonic Corporation

Web Site: <http://www.panasonic.com>