

# Operating Instructions Refrigerator

For Household Use

Model No.: NR-BX471C, NR-BX421B



NR-BX471C



NR-BX421B

## Contents

• Safety precautions.....	2
• Usage precautions .....	4
• Installation .....	6
• Parts identification .....	7
• Temperature control .....	8
• ECONAVI operation .....	10
• Quick Freezing .....	11
• Prime Fresh+.....	12
• Prime Fresh room.....	12
• Fridge room.....	13
• Freezer room.....	13
• Usage tips .....	14
• How to clean the refrigerator.....	15
• Troubleshooting.....	18
• Specifications .....	20

### ■ NON-CFC

This unit uses totally NON-CFC MATERIALS both for refrigerant (R600a) and for insulation (Cyclo-Pentane). So, this refrigerator does not damage the Earth's ozone layer.

Thank you for purchasing the Panasonic product.

- Please read these instructions carefully and follow safety precautions on page 2-4 before using this product.
- Please make sure the date and name of store of purchase are stamped in warranty card and keep it with these operating instructions.

## Safety precautions

Please be sure to follow these instructions.



### WARNING

This sign means: It may lead to a serious injury or death.



These signs mean prohibited action.



This sign means required action.



This sign means the appliance must be earthed to prevent electric shock.



### CAUTION

This sign means: It may result in injury or property damage.



iso-butane

Risk of fire / flammable materials



### WARNING

Otherwise it may cause a fire, injury, electrical shock.

#### For power plug and cord:



- **Do not** plug or unplug with wet hands.
- **Do not** let the cord or plug be damaged.



- Disconnect power plug when cleaning.
- Plug into a wall outlet of the rated voltage on its own with the rated current and insert plug fully.
- Reserve one socket for the refrigerator only. Avoid connecting many appliances to the same socket and unroll through the length of cord.
- Remove dust periodically from the power plug.
- If the supply cord is damaged, it must be replaced by the manufacturer, its service agent or similarly qualified persons in order to avoid a hazard.
- If you detect burning smell, disconnect the power plug and ventilate the kitchen.
- **Stop** using the refrigerator and unplug the unit immediately if there is an abnormality or failure. Abnormality and failure examples:
  - Power cord or plug is abnormally hot.
  - Power cord is deeply cut or deformed.
  - There is burning smell.
  - You can feel tingling electricity.

#### When recycling the product:



- Before taking the refrigerator to be recycled, please remove all the door opening seal to prevent locking a child in it.
- The warning labels mentioned above should be kept throughout the life of the refrigerator.
- The operating instructions should be handed over to any person who would use or handle the refrigerator whenever the refrigerator would be transferred to another location and delivered to a recycling plant.
- Regarding to local laws, Cyclo-Pentane is used for insulation of this refrigerator. When you throw away this unit, please discard it by proper method and do not dispose it by burning.

Otherwise it may cause a fire, injury, electrical shock.



# WARNING

## When using:



- **Do not** damage the cooling circuit (piping on the back).
- **Do not** touch the compressor and pipes, because of high temperature, that there is a risk of burn injury.
- **Do not** let any children hang onto the refrigerator's door, it may overturn to the kid.
- **Do not** place any water container on the top of the refrigerator in case the spilling water causes electrical shock or combustion.
- **Do not** locate multiple portable socket-outlets or portable supplies at the rear of the appliance.
- Keep ventilation openings, in the appliance enclosure or in the built-in structure, clear of obstruction.



- This appliance is not intended for use by persons (including children) with reduced physical, sensory or mental capabilities, or lack of experience and knowledge, unless they have been given supervision or instruction concerning use of the appliance by a person responsible for their safety.
- Children should be supervised to ensure that they do not play with the appliance.

## In case of emergency:



R600a  
iso-butane



- Maintenance work only be carried out at workshop by well-trained maintenance worker.
- **Do not** store explosive substances such as aerosol cans with a flammable propellant and chemicals or scientific specimens in the appliance.
- **Do not** use electrical appliances such as a deodorizer in the refrigerator. Leaked refrigerant may catch fire from a spark of the electrical contacts and may cause an explosion.
- **Do not** use electrical appliances inside the food storage compartments of the appliance, unless they are of the type recommended by the manufacturer.



- **Do not** disassemble, repair or modify the refrigerator by yourself. If you want to repair the refrigerator, please consult your dealer or authorized service center.
- **Do not** use mechanical device or other means to accelerate the defrosting process, other than those recommended by the manufacturer.

## When installing:



- Fix the refrigerator to avoid danger due to unbalance.
- When positioning the appliance, ensure the supply cord is not trapped or damaged.



- Ensure that the refrigerator is plugged into an earthed mains socket.

Otherwise it may cause injury, accidents.



## CAUTION

### When opening/closing the doors:



- While opening the refrigerator, be careful not to pinch other one's hand holding the door.
- Mind the gap between the doors. They may nip your hand while closing the door.

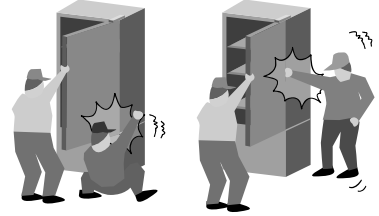

### When storing food:



- **Do not** freeze glass bottles, that there is a risk of injury. (If the liquid in a glass bottle is frozen, then the bottle may break and you may be injured.)
- **Do not** add a high impact on glass trays. (Otherwise those glass trays may break and you may be injured.)

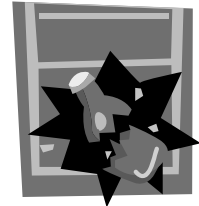

### When moving the refrigerator:



- Hold the refrigerator tightly when transporting.
- Apply protective covering, etc. to floors with a fragile surface.

## Usage precautions

### When opening/closing the doors:

- **Do not** refrigerate items which are bigger than tray or shelf, as the door will not close completely causing leakage of cool air.
- **Do not** open refrigerator frequently or leave it open for long time in order to prevent water dripping inside and waste energy.
- Frequently check the door opening seal, it must be closed to the refrigerator's body completely.

### When cleaning:

- **Do not** clean the refrigerator with chemical substance or liquid. It will cause damage and have corrosion on the surface.
- Clean the pan water evap located over the compressor at the back of the refrigerator every three months to prevent the odour generated from humidity.

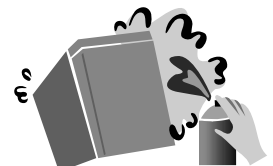

# Usage precautions

## When using:

- When the plug is disconnected, leave it for 5 minutes before plugging again. If not, the compressor may not work.
- Adjust the temperature according to the actual operating condition for energy saving.
- The humidity inside the fresh case may condense so wipe it with a cloth periodically. Clean the fresh case once a month.
- If you will not be at home for several days and there are nothing refrigerated in the refrigerator, the plug should be disconnected for energy saving.
- The outside wall of refrigerator cabinet may sometimes get warm, especially just after installation. This is quite normal, and is due to the built-in Mullion Dryer Pipe which prevents sweating and radiates heat.
- When humidity is high, e.g. during rainy-season, condensation may appear on the surface of cabinet, especially around the door seal gasket. Wipe off the condensed water with a clean cloth.
- **Do not** keep the door open any longer than necessary, particularly in hot, humid weather.



## When storing food:

- **Do not** place warm/hot foodstuff in the refrigerator.
- **Do not** overload the refrigerator. Gap must be provided between foodstuffs to maintain the cooling effect.
- Store fruits and vegetables in vegetable case, where trapped moisture helps preserve food quality for longer time periods.
- Drinking water, beverage bottles should be sealed to prevent odor contamination.
- Foodstuff such as vegetables, fruits and fresh food should be wrapped or packed in box before freezing and refrigerating.
- Put the food such as meat or fish in the freezer if you want to store for an extended period.
- Cover juicy food with tight lids, plastic film or foil.
- Cool hot dishes in room temperature before placing them in your refrigerator.

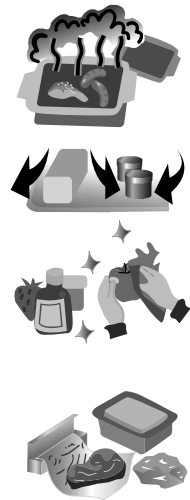

## SPECIAL FEATURE

### 1) ECONAVI

The microchip performing ECONAVI mode is integrated into the main control board. By detecting refrigerator's frequency of use (opening and closing of door), ECONAVI mode automatically operates to save energy.

### 2) INVERTER

In accordance with temperature change inside the compartment, the motor of compressor runs at different speed. When the temperature is stable, the motor runs at a lower speed (energy saving & lower noise). When powerful cooling is required, the motor runs at a higher speed.

# Installation

## The distance requested for installation

- The top of the refrigerator and the ceiling at least 30 cm.
- The back of the refrigerator and the wall at least 10 cm.
- The sides of the refrigerator and the walls at least 5 cm.

## Area around the installed unit

- **Do not** locate the refrigerator in a humid place as rust may form and may cause electric leakage.
- **Do not** locate the refrigerator exposing to direct sunlight as the heat and sunlight will increase the temperature.
- **Do not** locate the refrigerator near heat source such as cooking stove or oven.
- **Do not** block the openings around the refrigerator.
- The refrigerator must be located in the place where there is good air circulation.
- In case of placing the refrigerator on an uneven surface, adjust the adjustable bolt to make the refrigerator stand stably.
- In order to prevent the refrigerator from tipping due to earthquakes, permanently fix it by using belts, etc.

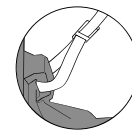
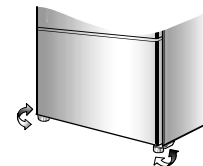
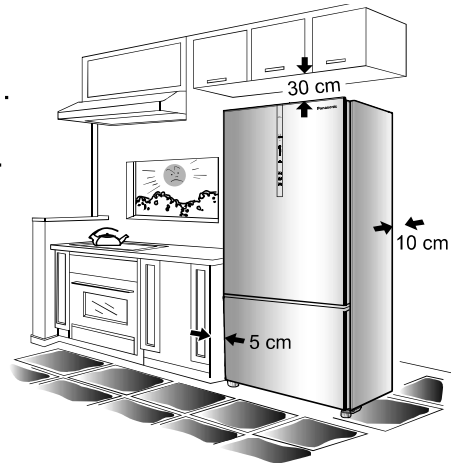

## Moving or shifting

- When moving or shifting the refrigerator, remove ice maker, freezer case, pan water evap, etc. and check to be sure that there is no water in the refrigerator.

## Power cord setting

- To bring power cord for use, pan water evap from left should be lifted up. Then bring the power cord out and then insert pan water evap into the block by pressing at both the sides.

## LED lamp and grounding

- The refrigerator LED lamp, specially designed for this refrigerator, do not replace it by yourself. If you need replacement, please contact Panasonic Service Center.
- If there is no grounding wiring plug in refrigerator, it should be connected with grounding connection to prevent electrical hazard from electric leakage.

## For safety, the ground connection should be done

(For a refrigerator with plug (2-pin plug) without any grounding wire)

The ground connection will allow prevention of danger resulted from electricity leakage.

The ground connection can be performed in 2 ways as follows:

1. In the case that the grounding receptacle having been prepared for the socket (plug socket), connect the ground wire to the screw used for ground connection at the bottom rear of the refrigerator (regarding the screw used for ground connection, please notice the ⚡ symbol) as shown in the illustration ①. And then connect the other end to the grounding receptacle.
2. In the case that the socket (plug socket) having not been provided with any grounding receptacle, connect the ground wire to the screw at the bottom of the refrigerator, (as regards the screw used for ground connection, please notice the ⚡ symbol). And then connect the other end to the ground rod as shown in the illustration ②.

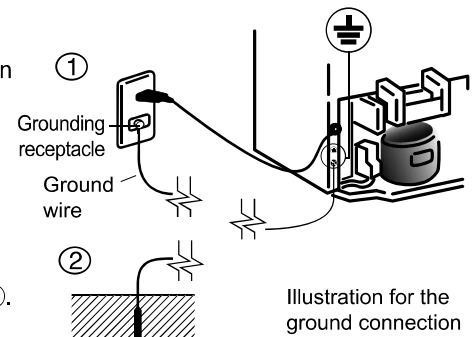

## Prohibited spots for ground connection

- Gas pipes and water supply pipes (dangers from electric shock or explosion).
- The ground wires of telephone cords and lightning rods (dangers from lightning).

# Parts Identification

- Ⓐ FRIDGE ROOM
- Ⓑ PRIME FRESH ROOM
- Ⓒ FREEZER ROOM
- ① LED lamp
- ② PC Glass tray
- ③ Glass tray crisper
- ④ Vegetable case
- ⑤ Prime Fresh case
- ⑥ Egg shelf
- ⑦ Egg tray
- ⑧ Bottle shelf
- ⑨ Gasket PC
- ⑩ Gasket FC
- ⑪ Ice twister
- ⑫ Ice box
- ⑬ Freezer case
- ⑭ Adjustable bolt
- ⑮ Pan water evap
- ⑯ Compressor

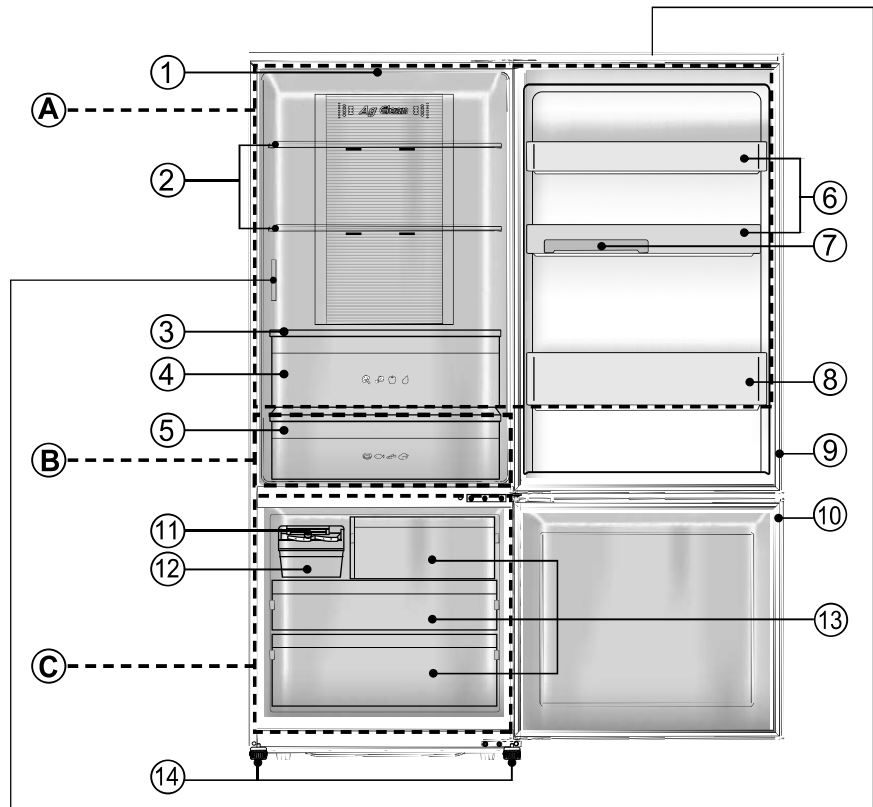

**Inside Control Panel  
NR-BX421B**

**Fridge (P.8)**

**Prime Fresh (P.8)**

**Freezer (P.8)**

**Quick Freezing (P.11)**

**Prime Fresh+ (P.12)**

**Door Control Panel  
NR-BX471C**

**ECONAVI (P.10)**

**LED display**

**Prime Fresh+ (P.12)**

**Quick Freezing (P.11)**

**Fridge (P.8)**

**Prime Fresh (P.8)**

**Freezer (P.8)**

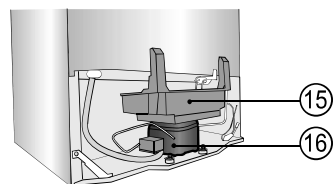

Product view from behind.

# Temperature control

## ■ Temperature setting and a guide of temperature



### 1. Model : NR-BX471C (Door Control Panel)

The temperature can be adjusted for Min-Max levels.

Touch the [Fridge] button to adjust temperature in Fridge room.

Touch the [Prime Fresh] button to adjust temperature in Prime Fresh room.



Touch the [Freezer] button to adjust temperature in Freezer room.

Temperature setting \ Button	[Fridge] (Fridge room)	[Prime Fresh] (Prime Fresh room)	[Freezer] (Freezer room)
<b>Max</b>  "Max"	Lower than "Med" by approx. 2 °C ~ 3 °C	Lower than "Med" by approx. 2 °C ~ 3 °C	Lower than "Med" by approx. 2 °C ~ 3 °C
<b>Med</b>  "Med"	Approximately 1 °C ~ 7 °C	Approximately -5 °C ~ -1 °C	Approximately -23 °C ~ -17 °C
<b>Min</b>  "Min"	Higher than "Med" by approx. 2 °C ~ 3 °C	Higher than "Med" by approx. 2 °C ~ 3 °C	Higher than "Med" by approx. 2 °C ~ 3 °C

### 2. Model : NR-BX421B (Inside Control Panel)

① Press the [Zone Select] button to select Fridge room [A], Prime Fresh room [B], or Freezer room [C\*].

② Press the [Temp. Select] button to select Max, Med, or Min levels.

Temperature setting \ Area	[A] (Fridge room)	[B] (Prime Fresh room)	[C*] (Freezer room)
<b>Max</b> 	Lower than "Med" by approx. 2 °C ~ 3 °C	Lower than "Med" by approx. 2 °C ~ 3 °C	Lower than "Med" by approx. 2 °C ~ 3 °C
<b>Med</b> 	Approximately 1 °C ~ 7 °C	Approximately -5 °C ~ -1 °C	Approximately -23 °C ~ -17 °C
<b>Min</b> 	Higher than "Med" by approx. 2 °C ~ 3 °C	Higher than "Med" by approx. 2 °C ~ 3 °C	Higher than "Med" by approx. 2 °C ~ 3 °C

**Generally, use the refrigerator with the temperature set to "Med".**

(If the temperature control of the freezer room or fridge room is set to other than "Med", ECONAVI does not operate.)



# Temperature control

## ■ How to operate the “9 levels” mode

The refrigerator is specially designed for appropriate use, which can adjust the temperature level to detailed 9 levels with the following details.

### 1. Model : NR-BX471C (Door Control Panel)

#### To adjust the temperature for the Fridge room

- ① Set the LED display to the “Min” position by touching the [Fridge] button.
- ② Touch and hold the [Fridge] button for 10 seconds until the LED display returns to show at the “Min” position.
- ③ Use the [Fridge] button to set the required temperature mode, where level 1 is the minimum cooling mode and level 9 is the maximum cooling mode. (As specified in the LED Display table.)

#### To adjust the temperature for the Freezer room

Follow steps ① ~ ③ above, but select Freezer room [Freezer] instead of Fridge room [Fridge].

### 2. Model : NR-BX421B (Inside Control Panel)

#### To adjust the temperature for the Fridge room

- ① Set the LED display to “Min” position by pressing the [Zone Select] button to select [A] (Fridge Room) then press the [Temp. Select] button to select “Min”.
- ② Press and hold the [Temp. Select] button for approximately 10 seconds until the LED display returns to the “Min” position.
- ③ Use the [Temp. Select] button to set the required temperature mode, where level 1 is the minimum cooling mode and level 9 is the maximum cooling mode. (As specified in the LED Display table.)

#### To adjust the temperature for the Freezer room

Follow steps ① ~ ③ above respectively while pressing the [Zone Select] button and selecting [C\*] (Freezer room) instead of [A] (Fridge room).

#### ●LED Display table (Model : NR-BX471C)

Cooling Level	Minimum  Maximum								
	1	2	3	4	5	6	7	8	9
LED Display									

#### ●LED Display table (Model : NR-BX421B)

Cooling Level	Minimum  Maximum								
	1	2	3	4	5	6	7	8	9
LED Display									

# Temperature control

## ■ To reset the setting “9 levels” mode

Repeat steps ① and ②, then the refrigerator returns to normal operation mode.

### Remark

- Prime Fresh room does not have “9 levels” mode.
- The temperature control can vary depending on the environment and amount of food stored in the refrigerator.

# ECONAVI Operation

## 1. Model : NR-BX471C

The refrigerator detects the opening and closing of the refrigerator door and the brightness around the refrigerator to control operations automatically to ensure maximum energy saving.\*1

### ■ ECONAVI operation

- The refrigerator learns the lifestyle patterns of your family from door opening and time periods of infrequent use to maximise energy efficiency.
- The refrigerator learns your lifestyle patterns from the previous 3 weeks of use and uses that data from the 4th week onwards. Therefore the ECONAVI lamp “ON/OFF” pattern may change from the 4th week onwards.
- The refrigerator performs the ECONAVI energy saving operation when it becomes dark\*2 around the refrigerator such as overnight when you are asleep.
- The brightness of the ECONAVI lamp is lowered approximately 5 minutes after the lamp turns on.

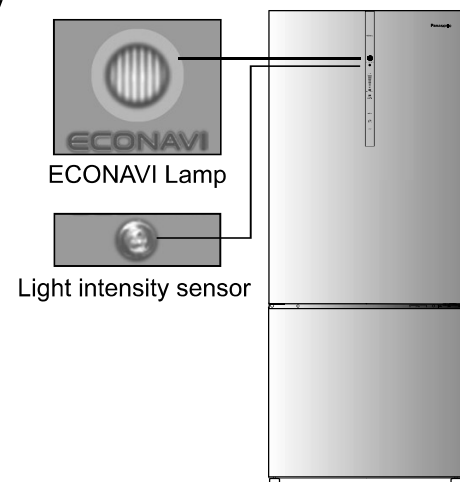

### ■ Settings for enabling ECONAVI operation

- ECONAVI operation is automatically enabled when the temperature control for both the freezer and refrigerator compartment is set to “Med”.
- ECONAVI mode does not operate if the “Quick Freezing” or “Prime Fresh+” mode is in operation.
- It is not possible to force to start of the ECONAVI mode.

### Remark

\*1 The effectiveness of the ECONAVI mode is dependant on the ambient temperature, ambient brightness and the number of times the refrigerator door is opened and closed and the state in which food is stored.

\*2 Darkness is detected by the light intensity sensor at approximately 3 lx to 10 lx or less.

## 2. Model : NR-BX421B

This model also has ECONAVI mode, but it does not feature ECONAVI lamp and light intensity sensor.

# Quick Freezing

When “Quick Freezing” is set, the refrigerator will reduce the temperature quickly for better performance of preserving food.

## ■ How to operate the “Quick Freezing” mode

### 1. Model : NR-BX471C



Lamp is on: Quick freezing is operated  
Lamp is off: Quick freezing is not operated

- Touch the button [Freezer] until the light LED [Quick Freezing] turns on. “Quick Freezing” mode starts after about 10 seconds.

### 2. Model : NR-BX421B



Lamp is on: Quick freezing is operated  
Lamp is off: Quick freezing is not operated

- Press the button [Zone Select] to select [C\*] (Freezer Room), then press [Temp. Select] until the light LED [Quick Freezing] turns on. “Quick Freezing” mode starts after about 10 seconds.

## Remark

- If you want to stop the "Quick Freezing" operation immediately, please repeat step 1 or step 2 until the light LED [Quick Freezing] turns off.
- The “Quick Freezing” operation will automatically stop after 60 mins (as ambient temperature is 18°C or lower) or 150 mins (as ambient temperature is 19°C or higher) and return to normal mode. (The light LED [Quick Freezing] turns off.)
- The light LED [Quick Freezing] flashing means that the defrosting system is now working. The “Quick Freezing” mode will start right after the defrosting operation is finished.
- The Freezer temperature control will not operate during “Quick Freezing” mode as the compressor is already at maximum operating levels for the “Quick Freezing” mode.

# Prime Fresh+

## ■ How to operate the “Prime Fresh+” mode

### 1. Model : NR-BX471C

Touch the button [Prime Fresh] until the light LED [Prime Fresh+] turns on.

### 2. Model : NR-BX421B

Press the button [Zone Select] until the light [Prime Fresh] turns on, then press the button [Temp. Select] until the light LED [Prime Fresh+] turns on.

#### Remark

- If you want to stop the “Prime Fresh+” operation immediately, please repeat step 1 or step 2 until the light LED [Prime Fresh+] turns off.
- The system will stop the “Prime Fresh+” operation automatically when it runs for 105 mins (as ambient temperature is 18°C or lower) or 145~150 mins (as ambient temperature is 19°C or higher) and return to normal mode. (The light LED [Prime Fresh+] turns off.)
- The light LED [Prime Fresh+] flashing means that the defrosting system is now working. The “Prime Fresh+” mode will start right after the defrosting operation is finished.

#### Remark

When “Prime Fresh+” mode is active, if you set the “Quick Freezing” mode, the “Prime Fresh+” mode will stop and fridge activates “Quick Freezing” mode and vice versa.

# Prime Fresh room

- This room is suitable for storing fresh food such as meat or fish.  
Compared to storing in the Fridge room, the storage life of meat or fish becomes longer.
- When food is frozen too much...  
Sliced raw fish or meat may be frozen too much. Set the temperature control to “Min” to prevent food from over frozen.
- When food is not partially-frozen...  
Depending on the type of food such as a block of meat or a large fish, the storage conditions and the ambient temperature, food may not be partially-frozen as it intended. Set the temperature control to “Max” (P.8).



#### Easy to cut.

The partially-frozen food is easy to cut!  
It comes in handy.



# Fridge room

The position of the second tray from the top can be changed

- ① Lift up the back of the tray and pull it forward. Once the protrusions of the tray are unhooked from rails, tilt the tray and remove it.

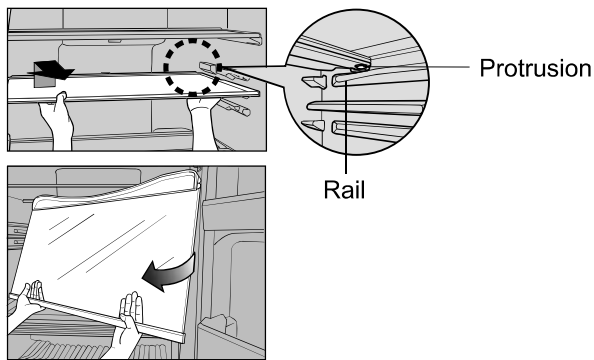

- ② Insert the tray in the desired position by reversing the steps.

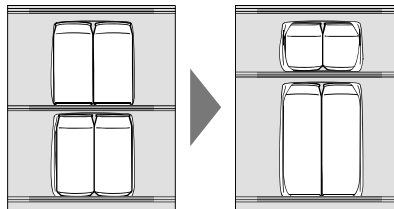

- Glass shelves are heavy. Please handle them with care so that they do not fall and cause any damage or injury.

# Freezer room

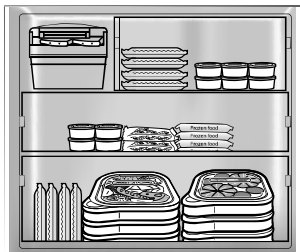

- A lot of frozen food and cooked meal can be stored.

## Three tips for freezing food and locking in the flavour...

1. Freeze thin and small items of food quickly!
2. Fully sealed
3. Do not refreeze

## To make ice

- 1 Take out the ice twister

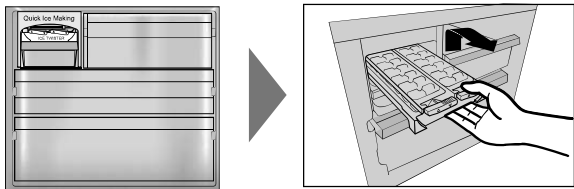

Pull out the ice twister. (P.17)

- 2 Fill with water

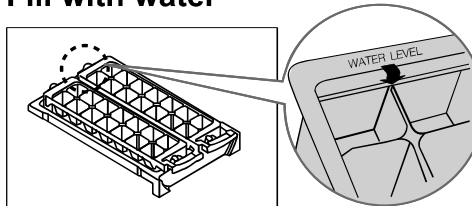

Fill water up to the "WATER LEVEL" line.

- 3 Install the ice twister

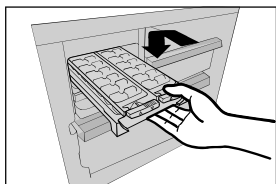

Place tray back into the ice making room.

- 4 To move ice cubes



Twist the ice twister clockwise.  
(The ice cubes will drop into the ice box.)

# Usage tips

## Where to store these different foodstuffs?

Approx.

**1°C~7°C**

**Fridge room**

### “Processed food and drinks...”

For regular storage of food and drinks or temporary storage of those to be served soon.



Approx.

**3°C~8°C**

**Vegetable case**

### “Fruits and vegetables”

A rather high humidity keeps fruits and vegetables fresh and juicy.

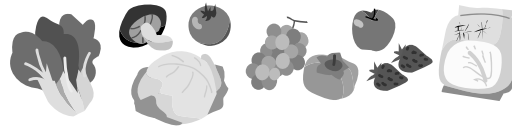

Approx.

**-5°C~-1°C**

**Prime Fresh room**

### “Fresh food...”

For storage of meat, fish, processed foods (such as hams and sausages) for 1 week with soft freezing.



Approx.

**-23°C~-17°C**

**Freezer room**

### “Dried or frozen foods...”

For storage of food for an extended period.

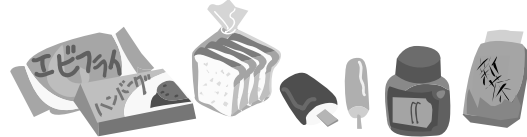

### Storage using hermetically sealed containers is recommended!

To prevent the interior from being discolored!



- Cut citrus fruits  
(→ The plastic will be discolored white.)

To prevent odors from spreading!



- Garlicky or other strong smelling vegetables  
(→ Odors will spread to other nearby food.)

# How to clean the refrigerator

Before cleaning or conducting maintenance, be absolutely sure to disconnect the power plug from the power outlet. Do not connect or disconnect the power plug with wet hands. When the plug is disconnected, leave it for 5 minutes before plugging again. If not, the compressor may not work.

## Clean the refrigerator immediately after it is stained!

Wipe off stains on the interior surfaces quickly before they harden.

In particular, cooking oil or lard may cause plastic to crack and citrus juice may cause the refrigerator to become discolored. When stains cannot be removed easily, wipe them with a cloth lightly soaked in neutral kitchen detergent. Then, wipe with a cloth lightly dipped in water.



Rub the door surface with a soft damp cloth.  
Rub the control panels with a dry cloth.

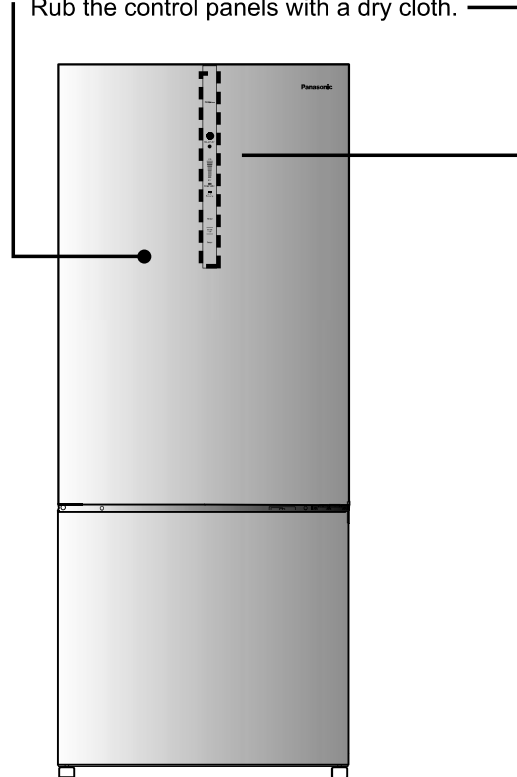

## Clean the detachable items occasionally.

Once a week for the ice twister. As a guide, remove the trays, door shelves, etc. and wash them by immersing them in lukewarm water every three months.



## Clean the door gasket at least once a month.

Clean by wiping with a soft damp cloth. Petroleum gel has been applied to the door gasket on the hinge side of the unit, be careful not to wipe this off.

Point where petroleum gel was applied.

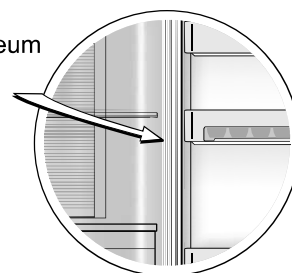

## Notices

The door gasket is replaceable by an authorised service agent. If the door gasket comes off while cleaning, it can be pushed back into the groove.

## Requests

Do not use the following items for cleaning. (Otherwise, the surface will be scratched or corroded.)



Kitchen detergents  
(They crack plastic!)

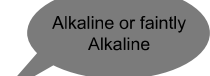

Cleanser or soap powder



Benzine, thinner, alcohol,  
acid, petroleum



Scrubber



Hot Water

# How to clean the refrigerator

## Trays

### ■ Removing

- ① Lift up the back of the tray and pull it forward. Once the protrusions of the tray are unhooked from the rails, tilt the tray and remove it.

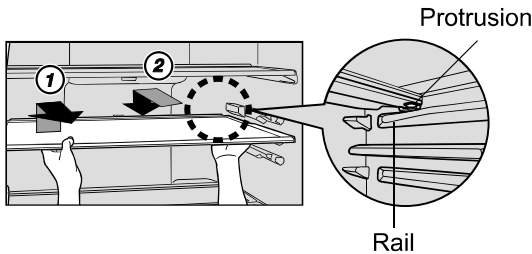

### ■ Attaching

- ② Push the tray until it reached the end lock.

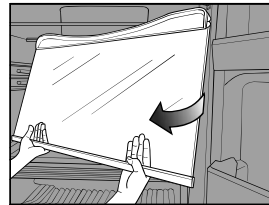

### Remark

- When removing the tray above the vegetable case, please pull out the vegetable case first and then follow to removing the tray as above details.
- In case of attaching the tray and it does not lock, make sure that you did not attach it the wrong tray.
- Trays are made of glass and heavy. Please handle them with care so that they do not fall and cause any damage or injury. For attaching trays, hold them with the protrusion side down and firmly insert.

## Egg shelf/Bottle shelf

### ■ Removing

- ① Lift it upward, alternating between the right and left side.

### ■ Attaching

- ② Placing it on both supporters, and then press until it reaches the end of supporters.

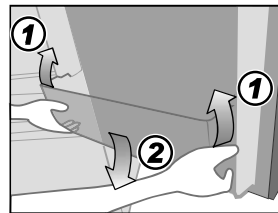

## Vegetable case/Prime Fresh case

### ■ Removing

- ① Pull the case unit forward until it reaches the end of the stopper.
- ② Lift the front of the case unit slightly and remove completely.

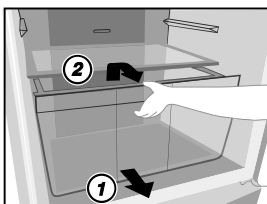

### ■ Attaching

- ① Insert the case unit into the supports.
- ② Raise the case unit up slightly and push forward until the end is reached.

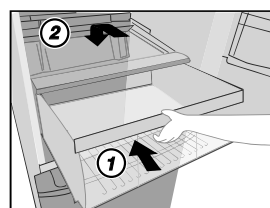



# How to clean the refrigerator

## ICE TWISTER (Quick Ice Making corner)

### ■ Removing

- ① Unhook the protrusion by lifting it upward and pulling the ice twister and ice box forward until completely removed.

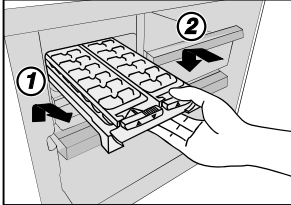

ICE TWISTER

### ■ Attaching

- ② Push the ice twister and ice box until it reaches the end lock.

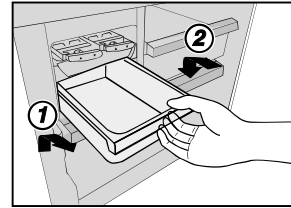

ICE BOX

### Attention

- You can disassemble the ice twister and ice box to increase space in the freezer.

# Troubleshooting

Before you call for service, please check the following items:

**The refrigerator does not operate.**

- Check that the plug and its socket are in good condition.
- Check if there is any problem on main fuse and electrical system of the house.
- Check by unplug and wait for 5 minutes before plugging it back in.

**The refrigerator does not cool enough.**

- Check to be sure that light in control panel is displayed at proper position.
- Check to see if the refrigerator is overloaded with stuff or there is any hot foodstuff refrigerated inside.
- Is the refrigerator exposed directly to sunlight or heat source?
- Is the refrigerator door completely closed?
- Is the refrigerator door opened frequently?

**Outside**

- When the ambient humidity is too high, the door gasket may have dew. This situation will be stopped if the air humidity decreases. Please wipe it up with dry cloth.

**Dew, snow appear.**

**Inside**

- Is the door closed firmly?
- Is the door being opened and closed too frequently?
- When too high weather humidity, long opening time or making too much ice, inside the freezer compartment may appear frozen snow. This is normal. Please wipe with dry and soft cloth.



**The refrigerator generates noise.**

- Check if the refrigerator is located on a stable floor or is installed properly.
- Check if there is any object in contact with the refrigerator.
- Cracking sound within caused by the parts adjusting temperature which is normal.
- After installation, the refrigerator may make loud noise. The noise will be less when the refrigerator has been cooled.
- There may be a whistling sound inside the refrigerator when opening and closing the door. This is caused by the air outside being drawn in through the pipe on the backside of the refrigerator to better balance the air circulation inside the unit.
- Check if evap pipe in contact with pan water evap.

# Troubleshooting

**Food becomes frozen.**

- Do you put the food near cold air holes?
- Do you adjust the temperature control at “Max”? Adjust to “Min”?
- Do you put food in prime fresh room?

**The inside is smelling.**

- Do you store the odour food without wrapping it?

**The surfaces of the refrigerator is hot.**

- Because the refrigerator is equipped with the dew prevention and heat radiation tubes, the surfaces of the refrigerator get warmer when operating.
- The back and side plates may get warmer especially when starting up or if the door is frequently opened and closed.

**The normal sounds of refrigerator.**

- When the refrigerator starts operation, the sound like water flowing and boiling water is created. This is the sound of the cooling liquid.
- The noise is generated when the automatic defrost system is operating.
- The dilatation of the details inside the refrigerator in the cooling process can cause sound “crack-crack”.
- You may feel that the operation sound is larger because the compressor operates at high speed under the following conditions: the refrigerator does not cool fully on the occasion such as using it for the first time, opening/closing the door too frequently, the surrounding temperature is high. The sound becomes more quiet after cooling fully.

**Lamp does not turn on.**

- Please contact Panasonic service center.

**The ECONAVI lamp does not light properly.**  
(Model : NR-BX471C)

**ECONAVI does not operate (the ECONAVI lamp does not light).**

- Has the “Quick Freezing” mode been activated? (P.11)
- Is the temperature setting of the freezer compartment and fridge compartment set to something other than “Med”?
- Has the door been opened frequently or has hot food been placed in the refrigerator?
- The learning function may automatically disable ECONAVI operation during times of frequent use.

**ECONAVI operation is rarely performed.**

- Is there a power failure?  
If a power failure occurs, the learning function data collected up until the point of power failure will be lost. The ECONAVI operation will rarely be performed until the learning function has collected data again.

# Troubleshooting

The ECONAVI lamp does not light properly.  
(Model : NR-BX471C)

ECONAVI operation is stopped part way though.

- If the auto defrost function is turned on during ECONAVI operation, the normal cooling operation will need to be performed after defrost. Therefore the ECONAVI operation may be stopped during this defrost/cooling process.
- The learning function may sometimes restart the normal cooling operation.

ECONAVI operation is performed too often (the ECONAVI lamp rarely turns off).

- Is the light intensity sensor hidden?
- Are there dirt or scratches on the control panel where the light intensity sensor is located?
- ECONAVI operation may be performed while the refrigerator is being used depending on the conditions of use, but the cooling performance is maintained.

# Specifications

Model No.		NR-BX471C	NR-BX421B
Freezer Star Rating		✱ ***	
Capacity (L)	Total	420	380
	Freezer	112	
	Fridge, Prime Fresh	308	268
Outside dimensions Width x Depth x Height (mm)		686 x 695 x 1790	686 x 695 x 1680
Refrigerant Type		R600a	
Net weight (kg)		67	65
Cooling System		Non-frost cooling.	
Rated Voltage (V) Rated Frequency (Hz)		Refer to the rating label attached inside the cabinet.	

Panasonic Corporation  
Website: <http://www.panasonic.com>

© Panasonic Appliances Vietnam Co., Ltd. 2021

*Imported by:*

Panasonic Manufacturing Philippines Corporation  
Ortigas Avenue Extension, Taytay, Rizal

*Contact Center:*

E-mail: [pmpc\\_csdic@ph.panasonic.com](mailto:pmpc_csdic@ph.panasonic.com)

Tel. No.: (02) 8706-7603

Text hotline:

Globe/TM Users: Panasonic<space>message to 21584703

Smart/Sun/Talk'NText Users: Panasonic<space>message to 225654703

Website: [www.panasonic.com/ph](http://www.panasonic.com/ph)