

Panasonic®

Operating and Installation Instructions

Induction Hob

Household Use

Model No.: KY-R72AEL

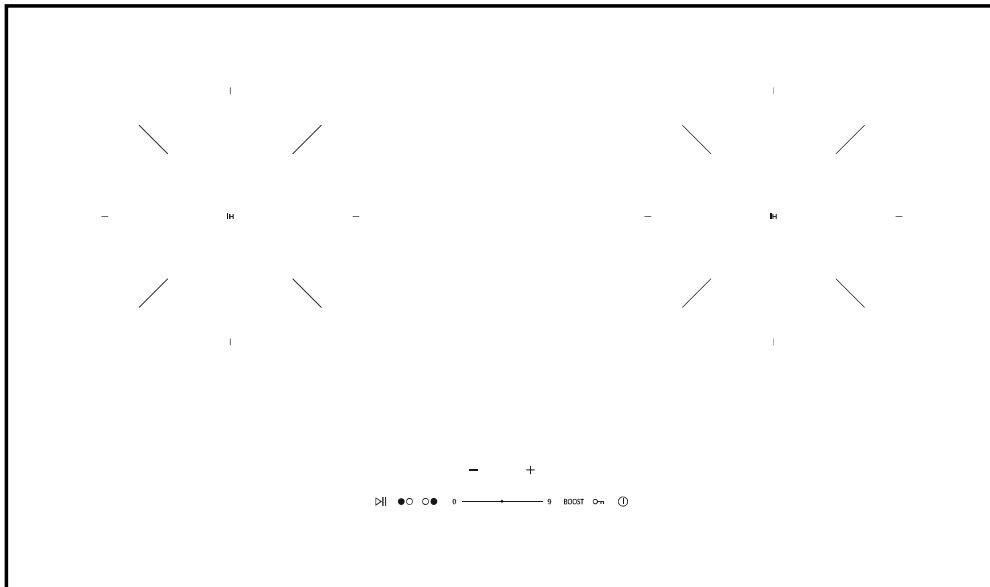

Operating and Installation Instructions 2 - 26

Thank you for purchasing this Panasonic product.

- This appliance is intended for household use only.
- Please read these instructions carefully before attempting to install, operate or service this product.
- For optimum performance and safety, please read these instructions carefully and follow safety precautions when using this product.
- Before using this product **please pay extra attention to “Safety Precautions” (Page 3 - 5).**

Keep these Operating and Installation Instructions for future use.

Table of Contents

Safety Precautions	3 - 5
Parts Identification	6 - 7
• Control Panel	6
• Suitable Cookware	7

Using the Induction Hob	8 - 15
• Operating the Induction Hob	8 - 10
• Timer Function	10 - 11
• Boost Function	11
• Safety Features for Induction Hob	12 - 13
• Cooking Guidelines	14 - 15
Cleaning and Maintenance	16 - 17

Troubleshooting	18
Failure Display and Inspection	19
Specifications	20

For Installer

Installation Instructions	21 - 26
• Safety precautions for installation	21 - 22
• Accessories	22
• Installation Requirements	23 - 25
• Electrical Connection	26

Safety Precautions

Make sure to follow these instructions

In order to prevent accidents or injuries to the users, other people, and damage to property, please follow the instructions below.

- The following charts indicate the degree of damage caused by wrong operation.

 WARNING Indicate serious injury or death.	 CAUTION Indicate risk of injury or property damage.
--	--

- The symbols are classified and explained as follows.

 These symbols indicate prohibition.	 This symbol indicates requirement that must be followed.
---	--

WARNING

 Stop using the product when any abnormality / failure occurs and turn 'OFF' the isolating switch or remove power plug if fitted.

(Risk of smoke/fire/electric shock)

Example of abnormality / failure:

- Abnormal noise or heat.
- Fire or oil ignition.
- Abnormal emission of smoke, fire.
- The product sometimes does not start when turned on.
- The power is sometimes disconnected when the cord is moved.
- Burnt odour or abnormal noise is detected during operation.
- The body is deformed or abnormally hot.
- The Glass Panel is cracked.

Contact a Panasonic Authorised Service Centre immediately for maintenance / repair.

 The Induction Hob must be earthed. Plug the power cord to socket outlet with earthing continuity terminal.

Improper grounding could cause electric shock.

 The means for disconnection must be incorporated in the fixed wiring in accordance with the wiring rules.

 This appliance is necessary to allow disconnection from the supply after installation. The disconnection may be achieved by having the plug accessible or by incorporating a switch in the fixed wiring in accordance with the wiring rules.

 This appliance is not intended to be operated by means of an external timer or a separate remote-control system.









 If the supply cord is damaged, it must be replaced by the manufacturer, its service agent or similarly qualified persons in order to avoid a hazard.

 Be sure to disconnect the Power Plug from the wall outlet or switch OFF the external switch before maintenance, repair or service. Also, do not handle the Power Plug or external switch with wet hand.









 When disconnecting the Power Plug, hold the plug itself. Do not pull the cord in anyway. The cord may be damaged and may cause fire or electric shock.

 Insert the Power Plug firmly, otherwise it may cause fire or electric shock.

WARNING

-  Clean the Power Plug regularly with dry cloth, otherwise, it may cause insufficient insulation due to moisture, and may cause fire.
-  In case of malfunction or breakdown, immediately stop using the appliance. Turn off the main power switch and the circuit breaker, and then contact the service center. Failure to do this may cause smoke, burns, and electric shock.
-  This appliance is not intended for use by persons (including children) with reduced physical, sensory or mental capabilities, or lack of experience and knowledge, unless they have been given supervision or instruction concerning use of the appliance by a person responsible for their safety. Children should be supervised to ensure that they do not play with the appliance.
-  Unattended cooking on a hob with fat or oil can be dangerous and may result in a fire.
-  If the surface is cracked, switch off the appliance to avoid the possibility of electric shock.
-  Do not damage the power cord or Power Plug.
-  Do not connect the power voltage other than 220 - 240 V ~ , may cause fire or electric shock.
-  Avoid using for deep frying. Overheated oil may catch fire when it is used for deep-frying because this Induction Hob does not have the "Oil Temperature Control System".
-  Must not disassemble the Induction Hob for reconstruction.

CAUTION

-  Installation and servicing must be carried out by competent persons in accordance with the regulation in force.
-  Before the appliance is put into operation, all the protective film applied must be removed.
-  Stir liquids (For example: soup, stewed food) before heating. If the liquid is heated without stirring:
 - The cookware may jump and damage the Glass Panel.
 - The liquids splatter and may cause burns or injuries.
-  Keep all combustible material away. It may cause fire.
-  After use, switch off the Induction Hob element by its controls (OFF/ ON switch and main power switch) and do not rely on the pot detector (safety functions).
-  The cooking process has to be supervised. A short term cooking process has to be supervised continuously.
-  Keep pots stable. May cause injuries or burns if the pots fall off.
-  If acidic food (For example: vinegar, jam, food which contains lemon or plum) sticks to the Glass Panel, wipe it off immediately. Otherwise, the Glass Panel may be discoloured.

CAUTION



When stir frying with Induction Hob, observe the following points:

- Do not leave this Induction Hob unattended.
- Do not overheat.
- Use lower power level for preheating. (If a small quantity of oil is used and heated excessively, the oil temperature will rise rapidly and the oil may catch fire. If the bottom of the pot is thin, it may become red due to the heat).



When using the power level “9” of Induction Hob:

- Do not use for stir frying. The bottom of the pot may be deformed.
- Do not use for simmering. The ingredients may boil over.
- When boiling water, turn down the power level as soon as the water has boiled. Water may boil or splatter around.



Please use caution when unpacking, installing or moving this product, as some exposed edges may be sharp to the touch and may cause injury if not handled with care.



To protect the Glass Panel from damage, observe the following instructions:

- Do not place portable gas burner, steel cylinders or canned goods. They would burst if mistakenly heated.
- Do not let metallic objects such as knives, forks, spoons, lids, aluminium foil / tray, retort pouch, magnetic ring, watch or accessories be placed on / near the top or be touched to cookware during Induction Hob is operating as they may get hot and cause burns or injuries.
- Do not apply high pressure on Glass Panel or drop things on it.
- Do not use harsh abrasive cleaners or sharp metal scrapers to clean the Glass Panel, since they can scratch the surface, which may cause shattering of the Glass Panel.



Spray cleaner is not to be used for cleaning.



A steam cleaner is not to be used. It may cause malfunction, if the water enters the electric parts.



Do not insert metallic objects such as pins or wire into the intake / exhaust vent.



Do not disassemble, attempt to repair or modify the Induction Hob.

For repair, contact the dealer or Customer care centre.



Do not replace the parts of the Induction Hob with spare parts other than authorised Panasonic parts.



Do not touch the Glass Panel during or after use. Be extra careful when the high temperature caution signal “H” lights up.

- Clean the Induction Hob after it has cooled down.



For proper use of this appliance, observe the following instructions:

- Do not place paper, or any material that may burn under the pot. The paper may scorch due to the heat of the pot.
- Do not heat empty pots or overheat. The ingredients may burn or the pot may be damaged.
- Danger of fire : Do not store items on the cooking surfaces.
- Do not use the product for purpose other than cooking.
- Do not heat and scorch empty enamelled pots. The Glass Panel may be damaged by melted bottom.
- Do not rub the Glass Panel with the bottom of the pot or place a hot pot on it. The Glass Panel may be damaged or discoloured.

Parts Identification

Parts Identification

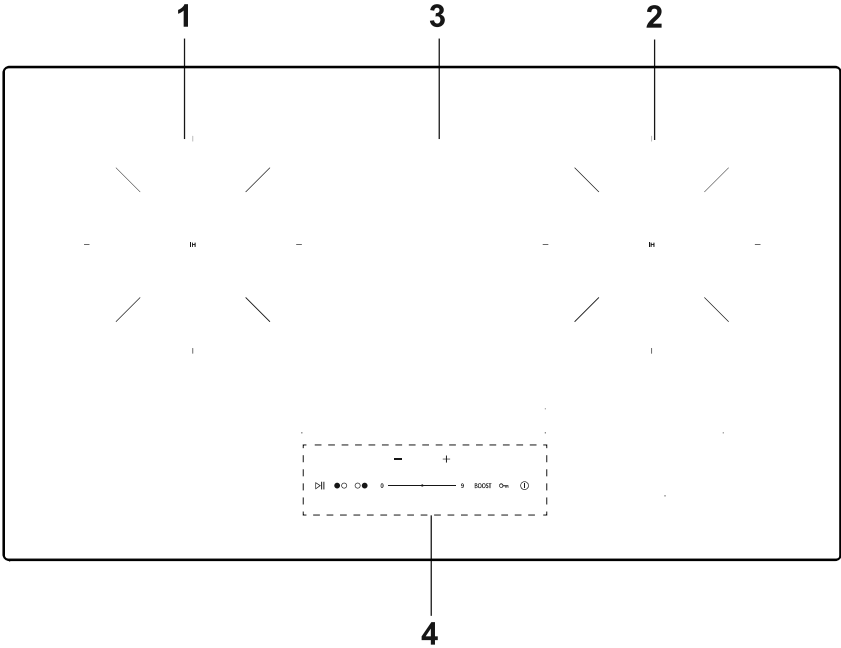

- 1. Cooking Zone 1 (Max.1800/2000 W)
- 2. Cooking Zone 2 (Max.1800/2000 W)
- 3. Glass Panel
- 4. Control Panel

Control Panel

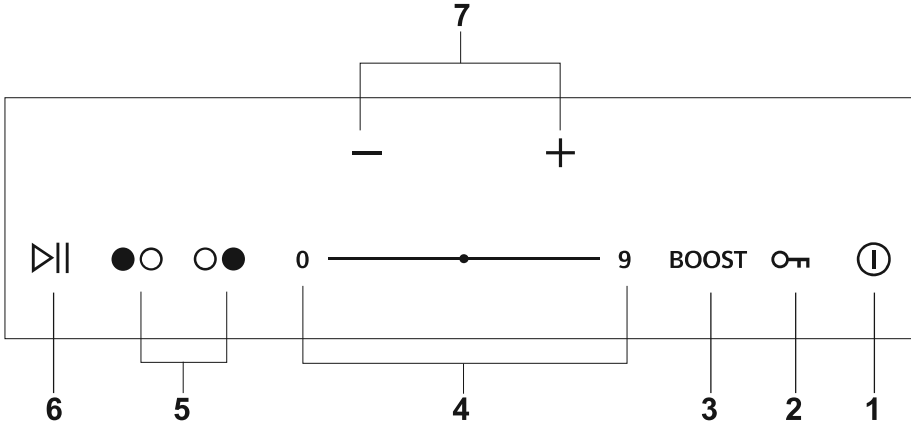

- 1. ON/OFF Control
- 2. Child Lock
- 3. Boost
- 4. Power Level Controls
- 5. Cooking Zone Selection Controls
- 6. Pause Control
- 7. Timer Setting Controls

Parts Identification

Suitable Cookware

Material

Compatible cookware



- Iron / Cast iron
- Enamelled iron
- Magnetic stainless steel

(The heating power may not be as strong for some stainless steel cookware.)

Incompatible cookware

- Aluminium / Copper
- Heat-resistant glass
- Ceramic and earthenware

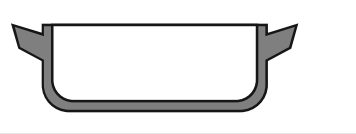
Shape of the bottom

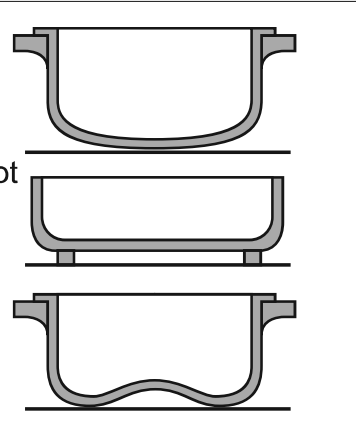
	<ul style="list-style-type: none">• The bottom is flat and has uniform contact with the Glass Panel.	
	<ul style="list-style-type: none">• Do not use if :<ol style="list-style-type: none">a. The cookware has a round-bottom.b. The pot has legs or protrusions.c. The cookware has a curved-bottom (A curve must not be 3 mm or more).<ul style="list-style-type: none">* If round-bottom or curved-bottom cookware is used, it cannot be heated, the safety functions do not activate properly, or power level might be lower.d. The cookware has a very thin bottom. (Might become warped.)	



CAUTION

- **The cooking zone and base of the pan must be kept dry.**
If there is liquid between them, it can cause steam pressure and the pan may move.
- **Do not heat up empty enamel cookware. Do not allow enamel cookware to scorch during cooking.**
Enamel coating may melt and damage the top plate.
- **Do not use ceramic and earthenware cookware even if it is made for induction heating.**
- **If the cookware is incompatible, “E” will appear and flash in the display.**

Using the Induction Hob

Operating the Induction Hob

Before use

- Read this guide, taking special note of the 'Safety Precautions' section.
- Remove any protective film that may still be on the Induction Hob.

Using the Touch Controls

- The controls respond to touch, so it is unnecessary to apply any pressure.
- Use the ball of the finger, not its tip.
- A beep will sound each time a touch is registered.
- Make sure the controls are always clean, dry, and that there is no object (e.g. a utensil or a cloth) covering them. Even a thin film of water could make the controls difficult to operate.

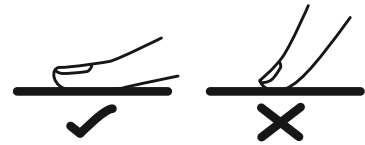

Start cooking

After connecting the induction hob to the power supply, a beep sounds, all displays show **B**, briefly.

Place a suitable cookware on the cooking zone. Make sure the bottom of the cookware and the surface of the cooking zone are clean and dry.

1. Touch and hold ON/OFF ① control to turn on the hob.
A beep sounds, all displays show “-” or “- -”, the induction hob enters the standby mode.
 - If 1 minute has elapsed without any operation, the main power automatically turns off.

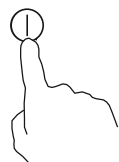

2. Touch the selection control of the heating zone placed on a cookware.
The power level indicator of the selected zone flashes. The power is initially set to level “5”.



Using the Induction Hob

3. Touch the slide control to set the power level while the power level indicator is flashing. The cooking zone starts heating when the power level indicator stops flashing.

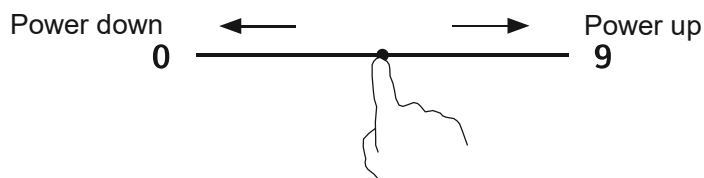

To change the power level during cooking, repeat step 2 to step 3.

Note:

- If the cookware is placed on the wrong cooking zone, or the cookware is not suitable for induction cooking, or the cookware is too small or not placed at center of the cooking zone, the power level indicator will flash $\triangleright \underline{U} \triangleleft$. No heating takes place unless there is a suitable cookware placed on the cooking zone. The display will automatically turn off after 2 minutes if no suitable pan is placed on it.

Pause cooking

You can pause the heating instead of shutting the hob off.

1. Touch $\triangleright \parallel$ to enter the pause mode.
All the indicators show " \parallel ". Both cooking zones enter pause mode.
2. Touch $\triangleright \parallel$ again to cancel the pause mode.

Note:

- Cooking zones cannot be paused separately.
- In the pause mode, all the controls are disabled except the ON/OFF control. You can always turn the induction hob off with the ON/OFF control in an emergency.
- The induction hob will shut down after 10 minutes in the pause mode.

Using the Induction Hob

Finish cooking

There are two ways to switch off the unit as follows:

- Touch the cooking zone selection control to choose the zone to be switched off. While the power level indicator is flashing, slide the power level to “0”.

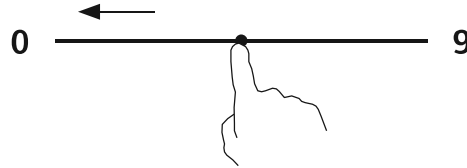
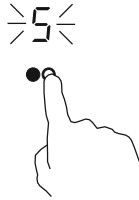

- Touch the ON/OFF control once to switch off.

Note:

- “H” will be shown until the cook zone surface is cooled down to a safe temperature. It can also be used as an energy saving function if you want to heat further pans, using the cook zone that is still hot.
- In the case of forgetting to switch off the unit, the induction hob will shutdown automatically based on default heating time. (Refer to “Auto Shutdown Protection”)

Timer Function

The timer can be used for either operation below:

- a) To set as Reminder. In this case, the timer will not turn any cooking zone off when the set time is up.
 - b) To set time to turn only one cooking zone off when the set time is up.
- To cancel the timer, touch — and + together, “00” will be shown on the display.

a). Using the Timer as a Reminder

Make sure the hob is turned on.

1. Touch the cooking zone selection control.
2. Wait for the power level indicator to stop flashing.
3. Touch — or + control of the timer to set the reminder time.(0-99 minutes)
 - Touch — or + control of the timer to decrease or increase by 1 minute once.
 - Touch and hold — or + control of the timer to decrease or increase by 10 minutes.
4. It begins to count down immediately. The timer indicator flashes for 5 seconds and the display shows the remaining time.

Note:

- A beep will sound for 30 seconds after the timer indicator shows “- -” indicating the setting time is finished. Touch any control to stop the beep.
- The heating will continue until the operation is cancelled, or the induction hob will shutdown automatically based on default heating time. (Refer to “Auto Shutdown Protection”)

Using the Induction Hob

b). Setting the Timer to Turn One Cooking Zone Off

Make sure the hob is turned on.

1. Select the heating zone to be used.
2. While the power level indicator is still flashing, touch — or + control to set the time.(0-99 minutes)
 - Touch — or + control of the timer to decrease or increase by 1 minute once.
 - Touch and hold — or + control of the timer to decrease or increase by 10 minutes.
3. A red dot flashing next to the power level indicator will be visible on the display . The dot indicates the cooking zone has been set the off timer.
4. It begins to count down immediately. The timer indicator flashes for 5 seconds and the display shows the remaining time.

Note:

- When the setting time expires, the corresponding cooking zone will be switched off automatically.
- The other cooking zone will keep operating if it is turned on previously.

Boost Function

1. Select the heating zone to be boosted the power level.

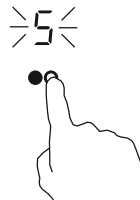

2. Touch Boost control to start boost function while the zone indicator is flashing. The power lever indicator shows "P".

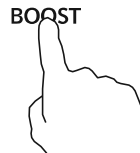

3. Touch the Boost control again to cancel the function.

Note:



- The cooking zone returns to its original power level after 5 minutes of boosting. If the original power level is "0", it will return to "9".
- When one cooking zone is in Boost mode, the highest power level of the other cooking zone can only be set to level 7.

Using the Induction Hob



Safety Features for Induction Hob

Child Lock Protection

To lock:

Touch and hold  for a while until a beep sounds and  keeps flashing on the display. All controls will be disabled, except the ON/OFF control in case of emergency.

To unlock:

Touch and hold  for a while until a beep sounds and  goes off. All controls are ready for use.

Note:

- The induction hob may always be turned off with the ON/OFF control in lock mode, but for any further operation it will first need to be unlocked.

Over-Temperature Protection

A temperature sensor equipped can monitor the temperature inside the induction hob. When an excessive temperature is detected, the hob will stop operating automatically.

Using the Induction Hob

Auto Shutdown Protection

Another safety feature of the hob is automatic shutdown. This occurs whenever you forget to switch off a cooking zone. The default shutdown times are shown in the table below:

Power level	1	2	3	4	5	6	7	8	9
Default working timer (hours)	8	8	8	4	4	4	2	2	2

Residual Heat Warning

When the Induction Hob has been operating for some time, there will be some residual heat. The letter **H** appears to warn the user to keep away from it. The letter **H** will disappear when the particular cooking zone has cooled down.

WARNING



Beware of hot surfaces.

Induction Hob will show which cooking zone is hot to touch with on the display. It will disappear when the surface has cooled down to a safe temperature.



Do not cover the cooking zone with flammable material such as cloth, alcohol contained detergent, etc. when **H** is displayed.

Using the Induction Hob

Cooking Guidelines

WARNING



Take care when frying as the oil and fat will heat up very quickly, particularly if cooking at high power levels. At extremely high temperatures, oil and fat will ignite spontaneously and this presents a serious fire risk.

■ **Cooking Tips:**

- When food comes to the boil, reduce the temperature setting.
- Using a lid will reduce the cooking time and save energy by retaining the heat.
- Minimise the amount of liquid or fat to reduce the cooking time.
- Start cooking on a high setting and reduce the setting when the food has been heated through.

Simmering, cooking rice

- Simmering occurs below boiling point, at around 85 °C, when bubbles are just rising occasionally to the surface of the cooking liquid. It is the key to delicious soups and tender stews because the flavours develop without overcooking the food. Egg-based and flour thickened sauces should be cooked below boiling temperature.
- Some tasks, including cooking rice by the absorption method, may require a setting higher than the recommended setting to ensure the food is cooked properly in the time recommended.

Searing steak

- To cook juicy flavoursome steaks:
 1. Stand the meat at room temperature for about 20 minutes before cooking.
 2. Heat up a heavy-based frying pan.
 3. Brush both sides of the steak with oil. Drizzle a small amount of oil into the hot pan and put the meat in the hot pan.
 4. Turn the steak only once during cooking. The exact cooking time will depend on the thickness of the steak and desired tenderness. The cooking time may vary from about 2 – 8 minutes per side. Press the steak to judge how cooked it is; the firmer it feels the more 'well done' it is.
 5. Leave the steak to rest on a warm plate for a few minutes to allow it to rest and become tender before serving.

Using the Induction Hob

For stir-frying

1. Choose a flat-based wok or a large frying pan.
2. Be ready with all the ingredients and equipment. Stir-frying should be quick. If cooking large quantities, cook the food in several smaller batches.
3. Preheat the pan briefly and add two tablespoons of oil.
4. Cook any meat first, put it aside and keep warm.
5. Stir-fry the vegetables. When they are hot but still crisp, turn the cooking zone to a lower setting, return the meat to pan and add seasoning.
6. Stir the ingredients gently to make sure they are heated through.
7. Serve immediately.

Power level

The settings below are guidelines only. The exact setting will depend on several factors, including type of cookware used and the cooking portion. Experiment with the Induction Hob to find the best setting.

Power level	Suitable cooking mode
1-2	<ul style="list-style-type: none">• Delicate warming for small amounts of food• Melting chocolate, butter, and foods that burn quickly• Gentle simmering• Slow warming
3-4	<ul style="list-style-type: none">• Reheating• Rapid simmering• Cooking rice
5-6	<ul style="list-style-type: none">• Pancakes
7-8	<ul style="list-style-type: none">• Sautéing• Cooking pasta
9	<ul style="list-style-type: none">• Stir-frying• Searing• Bringing soup to the boil• Boiling water

Cleaning and Maintenance

WARNING

Before performing cleaning and maintenance tasks, use isolation switch to disconnect the power supply. Children should not clean the Induction Hob or perform maintenance tasks.

What	How	Important!
<p>■ Everyday dirt on Glass Panel (fingerprints, marks, stains left by food or non-sugary spillovers on the Glass Panel)</p>	<ol style="list-style-type: none"> 1. Switch OFF the power of the induction hob. 2. Apply a neutral detergent when the Glass Panel has cooled down. 3. Rinse and wipe dry with a clean cloth or paper towel. 	<ul style="list-style-type: none"> • After the power has been switched OFF and there are no more hot Cooking Zones,  indication may disappear. However, take extreme caution as the surface of the Cooking Zone may still be hot. • Hard scourers, some nylon scourers and harsh/abrasive cleaning agents may scratch the Glass Panel. Make sure the cleaner or scourer is suitable. • Never leave cleaning residue on the Glass Panel. It may be permanently stained.
<p>■ Boil-overs, melt and hot sugary spills on the Glass Panel.</p>	<p>Remove these immediately with a palette knife or razor blade scraper that suitable for the Glass Panel, but beware of hot cooking zone surface:</p> <ol style="list-style-type: none"> 1. Switch OFF the power of the induction hob. 2. Hold the blade or utensil at a 30° angle and scrape the dirt or spill to a cool area of the Glass Panel. 3. Follow steps 2 to 3 for 'Everyday dirt on Glass Panel'. 	<ul style="list-style-type: none"> • Remove stains left by melts and sugary food or spillovers as soon as possible. If left to cool on the Glass Panel, they may be difficult to remove or even permanently damage the Glass Panel surface. • Cut hazard: when the safety cover is removed, the blade of a scraper is razor-sharp. Handle with extreme care and always store it safely, out of the reach of children. • Take extreme care when handling the blade or utensil, the Glass Panel may scratch.

Cleaning and Maintenance

<p>■ Spillovers on the touch controls.</p>	<ol style="list-style-type: none">1. Switch OFF the power of the induction hob.2. Absorb the spill with paper or dry cloth.3. Wipe the touch control area with a clean damp sponge or cloth.4. Wipe the area until it is completely dry with a paper towel.5. Switch ON the power to resume cooking.	<ul style="list-style-type: none">• The induction hob may beep and turn itself off, and the touch controls may not function when there is liquid on it.• Make sure the touch control area is dried before turning the induction hob back on.
---	--	---

Troubleshooting

Problem	Possible causes	Solution
The induction hob cannot be turned on.	No power.	Make sure the induction hob is connected to the power supply and that it is switched on. Check whether there is a power shortage in home or area. If everything has been checked and the problem still persists, call a Panasonic Authorised Service Centre for assistance.
The touch controls are not responding.	The controls are locked.	Unlock the controls. See section 'Safety Features for Induction Hob'.
The touch controls are difficult to operate.	There may be a slight film of water over the controls or you may be using the tip of your finger when touching the controls.	Make sure the touch control area is dry and use the ball of your finger when touching the controls.
The Glass Panel is scratched.	Rough-edged cookware. Unsuitable, abrasive scourer or cleaning products used.	Use cookware with flat and smooth bottom. See 'Shape of the bottom'. See 'Cleaning and Maintenance'.
Some cookware make crackling or clicking noises.	This may be caused by the construction of your cookware. (Layers of different metals vibrating differently).	This is normal for the cookware and does not indicate a fault.
The induction hob makes a low humming noise when used on a high heat setting.	This is caused by the technology of induction cooking.	This is normal, but the noise should quieten down or disappear completely when you decrease the heat setting.
Fan noise coming from the induction hob.	A cooling fan built into your induction hob has come on to prevent the electronics from overheating. It may continue to run even after you've turned the induction hob off.	This is normal and needs no action.
The induction hob or a cooking zone has turned itself OFF unexpectedly, sound and an error code is displayed (alternating with one or two digits in the cooking timer display).	Technical fault.	Note down the error letters and numbers, switch the power to the induction hob off at the wall, and contact a Panasonic Authorised Service Centre.

Failure Display and Inspection

The hob is equipped with a self diagnostic function. With this test the technician is able to check the function of several components without disassembling or dismantling the hob from the counter top surface.

No Auto-Recovery

Failure code	Problem	Solution
E1	Ceramic plate temperature sensor failure--open circuit.	Check the connection or replace the ceramic plate temperature sensor.
E2	Ceramic plate temperature sensor failure- -short circuit.	
E7	Ceramic plate temperature sensor failure.	
C1	High temperature of ceramic plate sensor.	Wait for the temperature of ceramic plate return to normal. Touch "ON/OFF" button to restart unit.
E3	Temperature sensor of the IGBT failure--open circuit.	Replace the power board.
E4	Temperature sensor of the IGBT failure--short circuit	
C2	High temperature of IGBT.	Wait for the temperature of IGBT return to normal. Touch "ON/OFF" button to restart unit. Check whether the fan runs smoothly; if not , replace the fan.
EL	Supply voltage is below the rated voltage.	Please inspect whether power supply is normal. Power on after the power supply is normal.
EH	Supply voltage is above the rated voltage.	
EU	Communication error.	Reinsert the connection between the display board and the power board. Replace the power board or the display board.

Specifications

Model	KY-R72AEL
Voltage	220 - 240 V~, 50 Hz or 60 Hz
Installed Electric Power	3500 W
Outside Dimensions (L x W x H)	Approx. 730 mm × 430 mm × 46 mm
Building-in Dimensions A×B (mm)	Approx. 680 mm × 380 mm
Net Weight	Approx. 6.4 kg

Note:

- Do not use this appliance above 2000 m, as this may affect the cooking effect.

Safety precautions for installation

Please read these precautions fully



WARNING

Failure to follow these instructions may cause a risk of personal injury or death.



Follow these instructions when installing the Induction Hob.

If it is installed improperly, it may cause electric leakage or overheat.



Install a dedicated circuit of single phase 220 - 240 V / 32 A, with a power switch for power supply.

If dedicated circuit is not connected compatibly, it may cause abnormal heat on electrical wiring.



Electrical work should be done by a qualified electrician.

If the connection or repair is not completed, it may cause electric leakage or overheat.



Install the ground completely with related law.

Installation of ground can avoid electric shock if electric leakage occurs



The ground should be installed by a qualified electrician.

If the installation is not proper, electric leakage may occur.



The means for disconnection must be incorporated in the fixed wiring in accordance with the wiring rules.



This appliance is necessary to allow disconnection from the supply after installation. The disconnection may be achieved by having the plug accessible or by incorporating a switch in the fixed wiring in accordance with the wiring rules.



Never disassemble, repair or modify the Induction Hob.

Any attempt to do so may cause the Induction Hob to operate abnormally and may result in danger.



CAUTION

Failure to follow these instructions may cause a risk of personal injury or death.



Use heat resistant materials for the counter top surface.

The material of the counter top surface should have the heat resistance equal to or exceeding “laminated thermosetting high-pressure decorative sheets”.

If the materials are not heat resistant, it may cause deformation or fire.

* Do not use varnished materials as they may be discoloured.



Do not step on or drop any hard article down on the Glass Panel.

If it is cracked or broken, it may cause overheating, abnormal operation or electric shock.



Do not touch the Glass Panel or other heating parts when the Induction Hob is running.

It may cause burn.

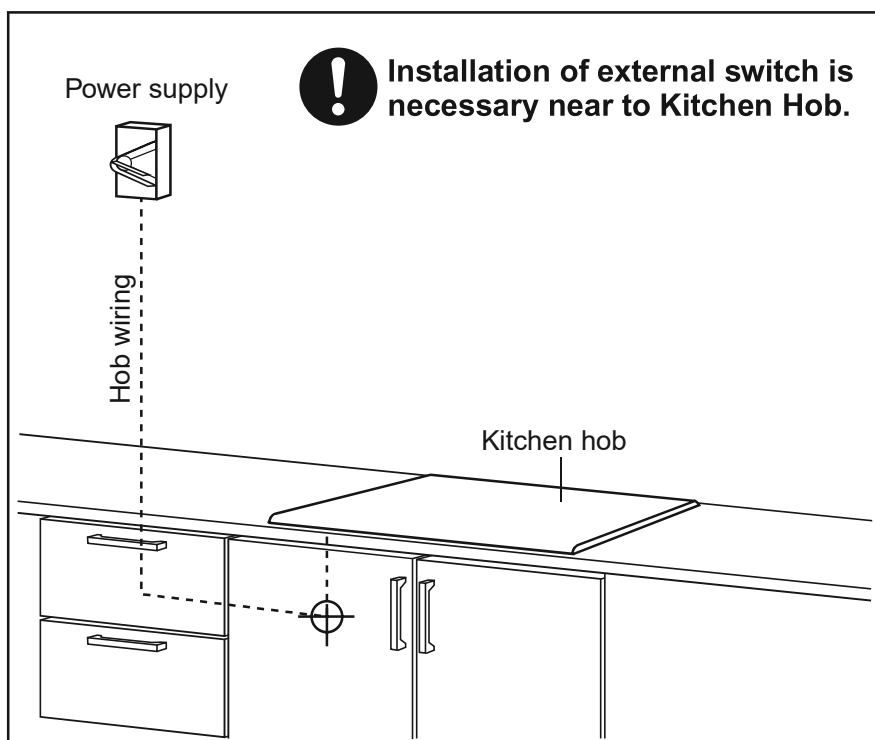

Accessories

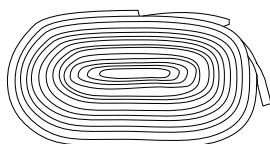

Sponge strips
(see page 23)

Installation Requirements

Cut out the counter top surface according to the sizes shown in the drawing. For the purpose of installation and use, a minimum of 50 mm space shall be preserved around the hole. Be sure the thickness of the counter top surface is at least 30 mm. Please select heat-resistant counter top surface material to avoid larger deformation caused by the heat radiation from the Induction Hob.

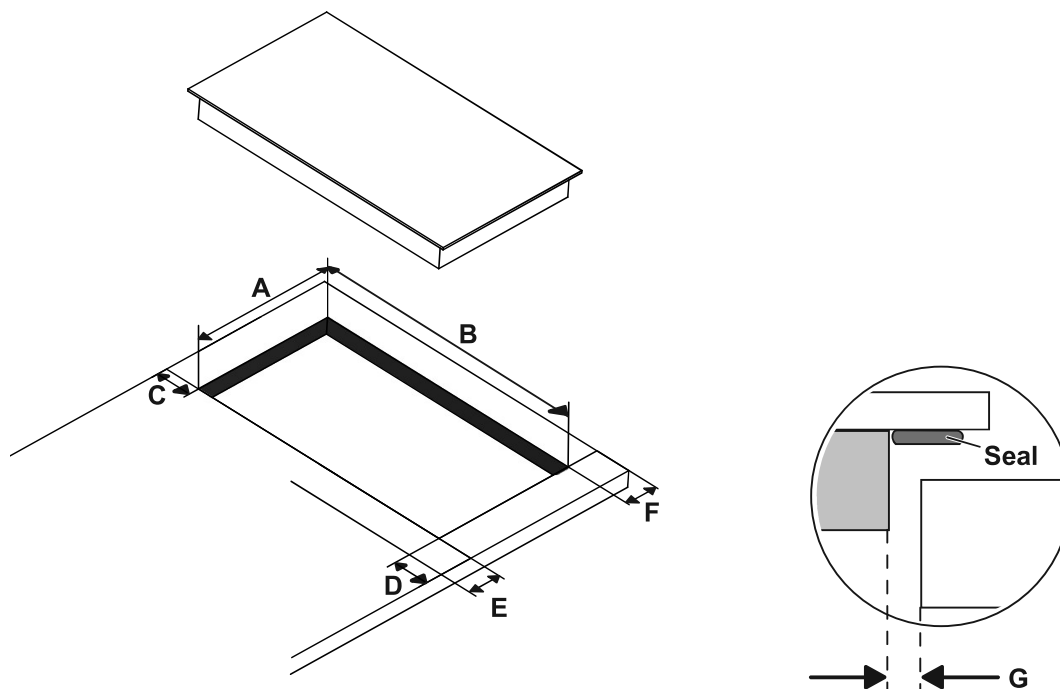

A(mm)	B(mm)	C(mm)	D(mm)	E(mm)	F(mm)	G(mm)
380 ⁺⁴ -0	680 ⁺⁴ -0	50 (Minimum)	50 (Minimum)	50 (Minimum)	50 (Minimum)	3 (Minimum)

Attach the sponge strips to the back of the glass panel, making sure the joints are secure.

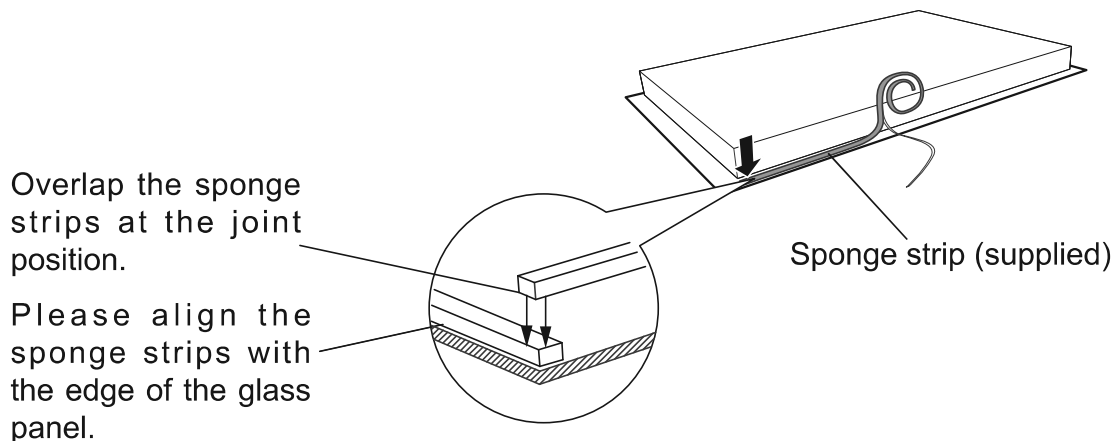

Installation Instructions

For Installer

Under any circumstances, make sure the Induction Hob is well ventilated and the air inlet and outlet are not blocked. Ensure the Induction Hob is in a good working state, as shown below.

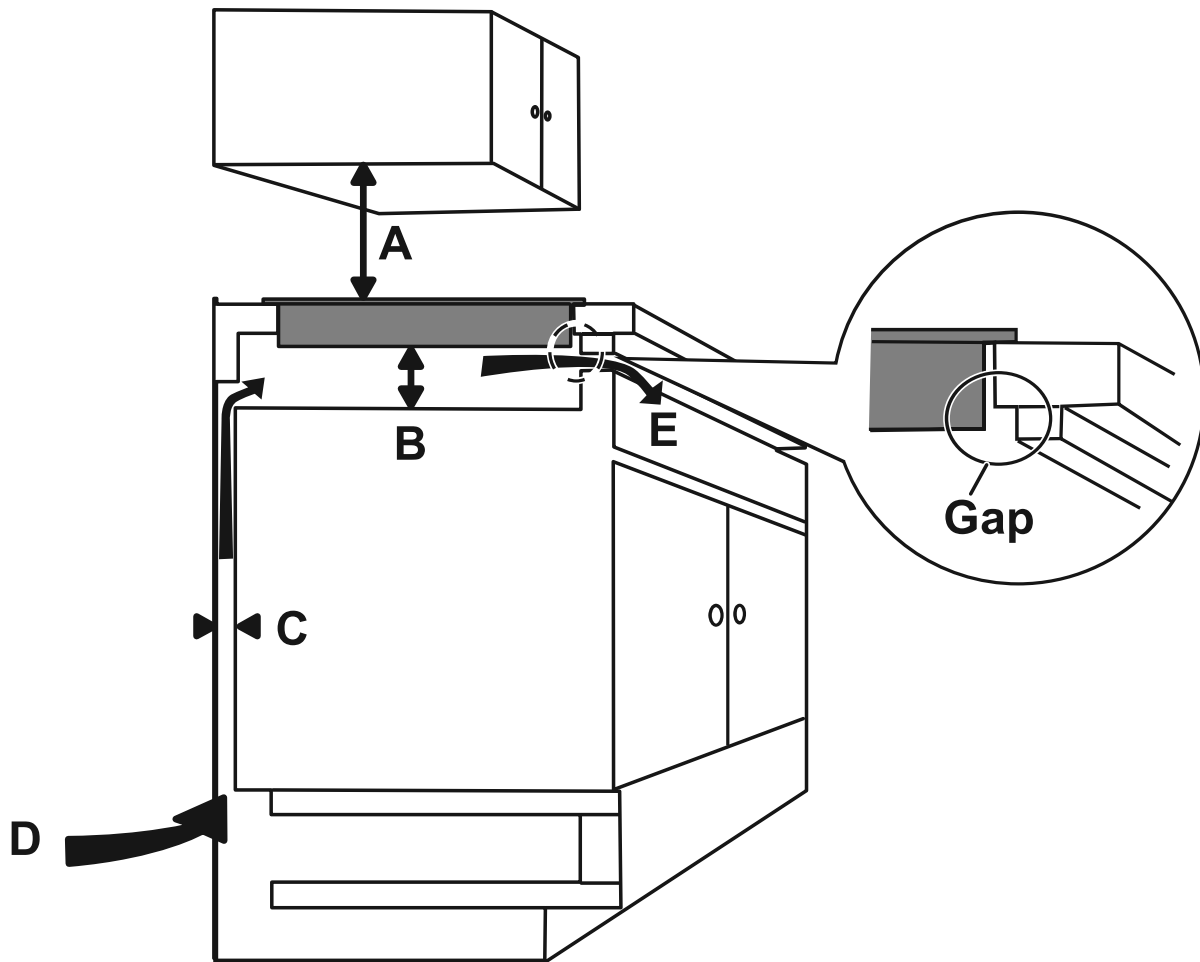

Note:

The safety distance for the Induction Hob installation as follows:

A (mm)	B (mm)	C (mm)	D	E (mm)
760	50 (Minimum)	20 (Minimum)	Air Intake	Air Exit 5

■ Before the Induction Hob is installed, make sure that:

- The counter top surface is square and level, and no structural parts interfere with space requirements.
- The counter top surface is made of a heat-resistant material.
- If the Induction Hob is installed above an oven, the oven has a built-in cooling fan.
- The installation will comply with all clearance requirements and applicable standards and regulations.
- A suitable power switch providing full disconnection from the main power supply is incorporated in the fixed wiring, mounted and positioned to comply with the local wiring rules and regulations.

The power switch must be an approved type and must provide a 3 mm air gap contact separation in all poles (or in all active [phase] conductors if the local wiring rules allow for this variation of the requirements).

- The power switch can be easily accessible before the Induction Hob is installed.
- Consult local building authorities and institutions if there are doubts regarding installation.
- Use heat-resistant and easy-to-clean finishes (such as ceramic tiles) for the wall surfaces surrounding the Induction Hob.

■ When installing the Induction Hob, make sure that:

- The power cord is not accessible through cupboard doors or drawers.
- There is adequate flow of fresh air from outside the cabinet to the base of the Induction Hob.
- If the Induction Hob is installed above a drawer or cupboard space, a thermal protection barrier is installed below the base of the Induction Hob.

IMPORTANT:

Correct installation is the responsibility of the installer. Any malfunction or accident resulting from the failure to follow the Installation Instructions is not covered by the warranty.

CAUTION



The Induction Hob must be installed by qualified personnel or technicians. Never conduct the operation by yourself.



The Induction Hob must not be installed directly above a dishwasher, fridge, freezer, washing machine or clothes dryer, as the humidity may damage the Induction Hob electronics.



The Induction Hob shall be installed such that better heat radiation can be ensured to enhance its reliability.



The wall and cooking zone above the counter top surface should be able to withstand heat.



To avoid any damage, the sandwich layer and adhesive materials must be resistant to heat.

Electrical Connection

CAUTION



Do not repair or replace any part of the appliance unless specifically recommended in the manual.

All other servicing should be done by a qualified technician. This may reduce the risk of personal injury and damage to the hob.

Never modify or alter the construction of the appliance by removing panels, wire covers, screws, or any other part of the appliance.

Wiring Connections

The appliance must be connected to earth in compliance with electrical system safety regulations.

A fixed connection is to be used, fitting the power line with an omnipolar circuit breaker with a contact opening gap equal to or greater than 3 mm, in an easily accessible position close to the appliance.

The wires in the mains lead fitted to this appliance are coloured in accordance with the following code:

Green and Yellow - Earth (E)

Blue - Neutral (N)

Brown - Live (L)

Panasonic Corporation

Website: <http://www.panasonic.com>

Printed in China

© **Panasonic Corporation 2026**

v1.0