

## Operating Instructions

Dishwasher (for household use)

Model No. NP-FVK16XE  
NP-FMK16XE

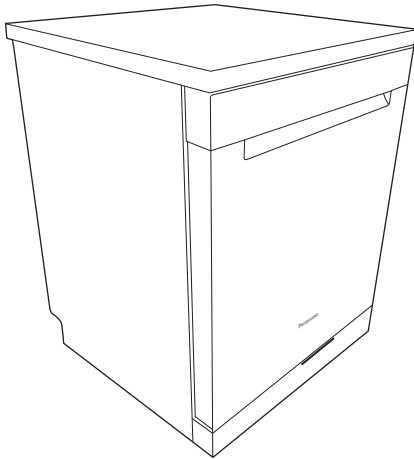

• nanoe™ is a trademark of Panasonic Holdings Corporation.

### Attached Installation Instructions

Thank you for purchasing this Panasonic product.

- This appliance is for indoor household use only, do not use outdoors.
- This appliance is intended to be used in household and similar applications such as:
  - staff kitchen areas in shops, offices and other working environments;
  - farm houses;
  - by clients in hotels, motels and other residential type environments;
  - bed and breakfast type environments.
- Read this Operating Instructions carefully before using this appliance, and save it for future use. Read the "Safety Precautions" (Pages 2 to 3) before use.
- In this Operating Instructions, NP-FVK16XE is abbreviated as FVK16, NP-FMK16XE is abbreviated as FMK16.
- The illustrations in this Operating Instructions are based on FMK16 as an example. The actual appliance may be different from the illustrations and descriptions.

### Contents Page

Safety Precautions .....	2
Notes for Use.....	4
Confirmation and Preparation Before Use.....	5
Part Names.....	6

Before Use

Quick Start Guide .....	8
Loading Tableware .....	10
Detergent .....	14
Programs and functions .....	16

How to Use

Maintenance .....	18
Preventing freezing / When Not in Use for A Long Time .....	20
FAQ.....	21
Troubleshooting .....	22
Error Code .....	23
Specifications.....	Back cover

When Necessary



P9947-25W10  
S0925-1016  
Jan. 2026

# Safety Precautions Must be followed

To prevent any personal hazard or property damage, follow the instructions below.

■ The hazard or damage caused by misuse can be categorized by the following degrees.



## WARNING

This indicates that the failure to follow the instructions may cause serious injury or death.



## CAUTION

This indicates that the failure to follow the instructions may cause minor injury or property damage.



## WARNING

- This appliance is not intended for use by persons (including children) with reduced physical, sensory or mental capabilities, or lack of experience and knowledge, unless they have been given supervision or instruction concerning use of the appliance by a person responsible for their safety.
- Children should be supervised to ensure that they do not play with the appliance.
- If the supply cord is damaged, it must be replaced by the manufacturer, its service agent or similarly qualified persons in order to avoid a hazard.
- This appliance incorporates an earth connection for functional purposes only.
- The door should not be left in the open position since this could present a tripping hazard.
- The ventilation openings must not be obstructed by a carpet.
- Knives and other utensils with sharp points must be loaded in the basket with their points down or placed in a horizontal position.  
(Risk of injury if improperly placed.)  
→ Load tableware according to pages 10 to 13. The maximum number of tableware to be washed is 15 place settings.
- Keep away from open flames and heat sources.  
(Risk of fire.)
  - e.g. mosquito coils, cigarettes, candles, electric heaters, etc.
- Do not allow infants or toddlers to crawl into the dishwasher.  
(The door cannot be opened from the inside, which may lead to accidental entrapment.)  
→ Always close the door after use.
- Do not disassemble, repair, or modify the appliance yourself.  
(Risk of fire or injury from abnormal operation.)  
→ Contact after-sales service for repairs.
- Do not misuse the power cord or plug.
  - Do not damage, modify, place near heat sources, bend forcibly, twist, pull, place heavy objects on, or bundle the power cord or plug.
  - Do not use a damaged plug or a loose outlet.
  - Do not plug or unplug with wet hands.  
(Risk of electric shock or fire.)
- Use the power cord and plug properly.
  - Fully insert the power plug into the outlet.
  - Regularly remove any dust from the power plug.
  - Unplug the power plug when the appliance is not in use for an extended period or during maintenance.
  - When unplugging, always hold the plug itself—do not pull the cord.  
(Risk of electric shock or fire.)

## WARNING

- **Do not spill water or detergent on the appliance or the power plug.**  
(Risk of electric shock or fire.)
- **Do not open the dishwasher during operation. Wait at least 30 minutes after the cycle ends.**  
(Hot interior surfaces, wash water, and steam may cause burns.)  
→Wait at least 30 minutes before opening the door (for removing tableware, cleaning, or maintenance).  
→If you need to open the dishwasher during operation, pause the operation before opening, and open the door slowly and carefully.
- **Do not touch the exterior surfaces of the dishwasher during operation.**  
(They may become hot and cause burns.)
- **Do not apply impact to the appliance during operation.**  
(Risk of electric shock, leakage, or fire.)
- **Do not apply weight to the open door.**  
(The dishwasher and tableware may tip over, causing injury.)
- **Ensure that the appliance is properly earthed.**  
(Risk of electric shock in the event of a malfunction or current leakage.)  
→Earthing work must be performed by a qualified technician.
- **If the appliance operates abnormally or malfunctions, stop using it immediately. Turn off the water supply valve and disconnect the power cord.**  
(Failure to do so may cause smoke, fire, or electric shock.)  
→Contact after-sales service for inspection or repair.

### Examples of abnormal conditions:

- The appliance does not operate even after the power is turned on.
- The door does not open or close properly.
- Unusual noise occurs during operation.
- The appliance body is deformed or becomes abnormally hot.

## CAUTION

- **The new hose-sets supplied with the appliance are to be used, the old hose-sets should not be reused.**
- **Do not touch the drain hose or exhaust outlet.**  
(Risk of burns due to hot air or steam being discharged.)
- **Do not forcibly close the door if tableware is protruding from the appliance.**  
(Risk of door deformation, hot water splashing, or burns.)
- **Be careful not to pinch your fingers when opening or closing the door.**  
(Risk of injury.)
- **Do not place heavy objects on top of the appliance.**  
(Risk of deformation due to excessive load.)

# Notes for Use



## Use The Dishwasher Correctly

- **Keep the appliance away from other electronic devices such as TVs or radios.**  
(Risk of image distortion or noise interference.)
- **Do not forcibly push or pull the door, or hang objects on it.**  
(Risk of damage, deformation, or malfunction.)
- **Do not manually add water for washing.**  
(Risk of water leakage, damage, or abnormal alarms.)
- **Do not use for purposes other than washing and drying tableware.**  
(Risk of malfunction.)
- **Do not use the dishwasher as a countertop or shelf.**  
(Risk of damage or deformation.)

## Suitable Detergent

- **Do not use dishwashing liquid or baking soda.**  
(These may produce excessive foam, resulting in water leakage or malfunction.)  
→ Use only dishwasher detergent.
  - Dishwasher tablet
  - Dishwasher powder
- **When soaking or pre-washing with dishwashing liquid, be sure to rinse off all detergent thoroughly before placing the tableware into the dishwasher.**

### Note

- **Do not install in areas where freezing may occur (below 0 °C).**  
(If left untreated after freezing, the water inlet valve or pipes may be broken.)  
→ If drainage or freeze protection is needed, contact after-sales service.
- **Do not use water with high impurities such as well water, as it may cause issues like poor water supply.**
- **This appliance can be connected to cold or hot water up to max. 60 °C. If the water connection can not be maintained below 60 °C, the appliance must be connected to cold water.**  
→ This appliance is suitable for water temperature of 5 °C ~ 60 °C .
- **At first, the rubber and plastic of the appliance may emit a temporary smell. There is no effect on the human body and will disappear after a period of time.**
- **Remove the cushioning material, tape, and other packaging materials in the dishwasher before use.**
- **This appliance is equipped with a water leakage protection function. If the power supply is cut off, this function will be disabled. In such cases, be sure to turn off the water inlet valve.**

# Confirmation and Preparation Before Use

## Items that cannot be washed

**Do not place tempered glassware.**  
(Risk of shatter and cause injuries.)



**Do not place lightweight items that can be easily blown away.**  
(Risk of breakage or smoke, burning, odours, etc.)

- Plastic spoons, lids

- Styrofoam container

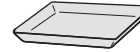

- Sponges, dishcloths, etc.

- Nipple of baby bottle

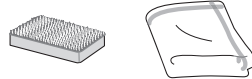

### Do not place the following items into the dishwasher

- ◆ Tableware that is not heat resistant (easily deformed by heat): Plastic tableware with a heat resistance of less than 60 °C, etc. (including tableware without heat-resistant labelling)



- For tableware with a heat resistance of 60 °C to 90 °C, use the "Delicate" program. (FMK16 only)

- ◆ Tableware that rusts easily: Iron pots and pans, kitchen knives, etc.



- ◆ Tableware with small openings that are difficult to clean inside: Bottles, jugs, etc.



- ◆ Fragile tableware: Tableware that is already cracked and broken, crackle-glazed tableware (tableware with cracked patterns), crystal glassware, tempered glassware, etc.



- ◆ Tableware prone to discoloration or peeling coatings: Silverware, aluminware, copperware, ironware, etc. Lacquered tableware, gold-plated tableware, painted tableware, etc.



## Preparation Before Washing

### Paste stains Burnt stains

Utensils after baking foods or steaming eggs, burnt pans, etc.  
→Soak and clean before loading.

### Food waste

Fine residue such as seasonings, spices or sesame seeds may redeposit.  
Toothpicks, fish bones or rubber bands may cause valve failure.  
Fish skin may cause odour.  
→Remove them beforehand.

### Tough soils

May redeposit.  
→Hand wash beforehand.

■ The following stains may not be completely removed.

- Accumulated tea stains
- Lipstick stains (some types)
- Food coloring on plastic tableware

■ If there is a lot of food coloring (ketchup, curry, etc.), it may stain the inside of the dishwasher, so wash it off beforehand.

# Part Names

Dishwasher interior

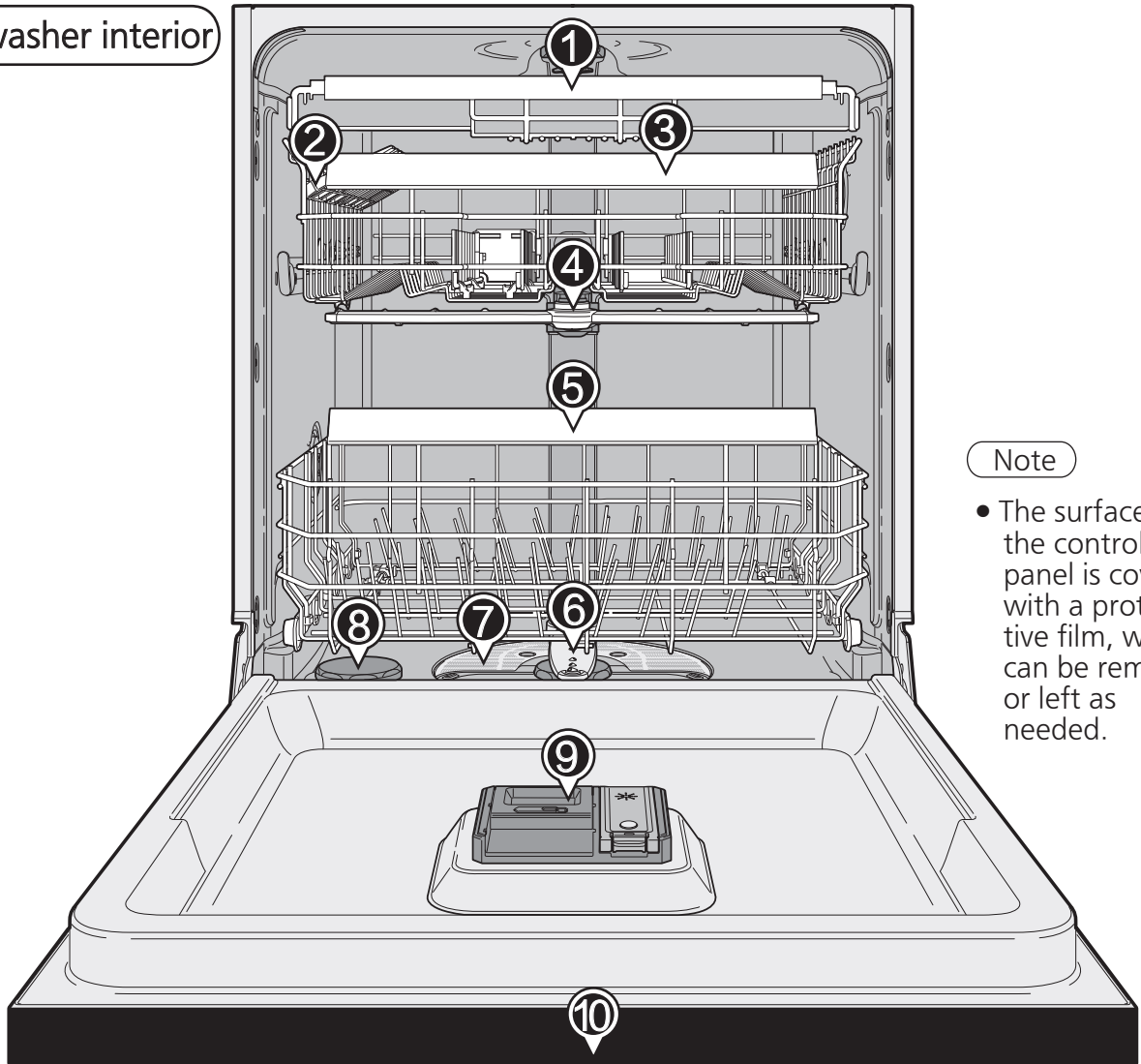

Note

- The surface of the control panel is covered with a protective film, which can be removed or left as needed.

No.	Part name	No.	Part name	No.	Part name
①	Cutlery tray	⑤	Lower basket	⑨	Detergent dispenser and rinse aid dispenser
②	Cup tray	⑥	Lower spray arm	⑩	Control panel (on the front of the door)
③	Upper basket	⑦	Filter		
④	Upper spray arm	⑧	Dishwasher salt container		

## Control panel

<Example of FMK16>

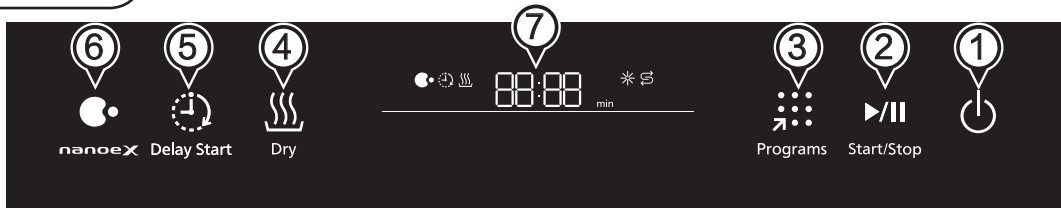

### ON/OFF button

①

- After turning on the power, the last program used is displayed by default (except when the last program was "Dry", "Sanitize", or "Self Clean").
- While the program is running or in the pause state, press and hold this button to turn off the power.

### Start/Stop button

②

- After setting the program, press this button to start running.
- If this button is not pressed after setting, the power will be automatically turned off after 10 minutes.
- If this button is pressed during running, the running program will be paused. Press it again to resume the running.

### Programs button

③

- Press this button, and the display will show the current program and the remaining time.
- Each press switches the program. Available programs vary depending on the model. (Page 16)

### Dry button

④

- Press this button and the display will show the current drying time.
- Each press of the button adjusts the drying time. (Page 16)



### Delay Start button

⑤





- Press this button and  will light up.
- Each press of the button adjusts the delay start time. (Page 17)

### nanoe™ X button (FMK16 only)

⑥

- Press this button to turn "Automatic nanoe™ X" on or off. The indicator light  turns on or off accordingly. When turned on (factory setting is "on"), it will run continuously for 7 days. (The operation duration can be adjusted. → Page 17)
- Press and hold this button to turn "Manual nanoe™ X" on. The indicator light  flashes and it will run for 12 hours.

### Display

Program	The current program is shown on the display. Available programs vary depending on the model. (Page 16)
	When the rinse aid is low,  lights up.
	When the dishwasher salt is low,  lights up.
⑦ 	<ul style="list-style-type: none"> <li>• When a program starts, remaining time until the end of the cycle is displayed. The number decreases over time, in minutes.</li> <li>• When "Delay Start" is set, the remaining time until start is shown. The remaining time decreases over time, in hours.</li> </ul> <p>(Example 1) <b>2:25</b> (Washing and drying will be completed in about 2 hours and 25 minutes.)</p> <p>(Example 2) <b>0 4h</b> (It will start running after 4 hours, and the number will decrease to "0 3h ..... " as time passes.)</p>

# Quick Start Guide

## 1 Preparations

- Make sure that all the tableware is suitable for washing in the dishwasher. (Page 5)
- Please check locations of the filter and spray arms.

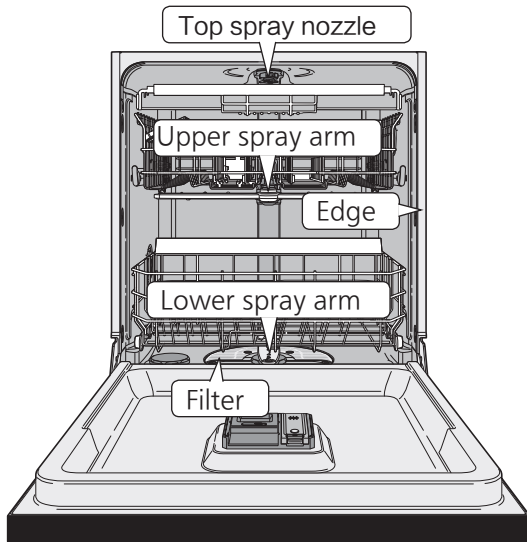

### Note

- Do not push or pull the door with excessive force. (It may cause the tableware to tip over or break.)
- Before closing the door, ensure that no tableware protrudes or touches the edges of the dishwasher.
- When closing the door, make sure your hand is not at the edge of the door to avoid getting pinched.

## 2 Loading tableware (Page 10 to 13)

### Cutlery tray

For loading knives, forks, spoons, etc. (Page 10)

Tall tableware should be placed on either side to avoid interfering with the top spray nozzle.

### Upper basket

For loading fragile and lightweight tableware such as glasses, cups, mugs, dessert bowls, etc. (Page 11)

### Lower basket

For loading pots, plates, melamine dessert plates, etc. (Page 12). Large plates and lids should be placed on either side to avoid interfering with the spray arms.

## 3 Adding detergent (Page 14 to 15)

- Use only dishwasher detergent.
- Read the precautions of the detergent carefully and follow its instructions.

## 4 Washing and Drying



1 Close the door and press the ON/OFF button to turn on the power.

2 Press the Programs button to select the program. Each press switches the program. (Page 16)

3 Press the Dry button to select the drying time. Each press adjusts the drying time (Page 16). (Except for "Dry", "Delicate" or "ECO" programs.)

4 Press the Start/Stop button to start operation.

### Change Settings

Once the settings are completed and the program starts, if you want to change the Settings:

- ① Press and hold the ON/OFF button for more than 3 seconds to turn off the power.
- ② Turn on the power again and make the settings.

#### Note

- If you need to open the door during operation, open slowly. (Hot water may splash out.)
- If the door is opened, an alarm will sound.  
→ Once the door is closed, the program will resume automatically.

## 5 End of Program

- At the end of the program, the buzzer beeps 6 times. Then
  - (FMK16 only) The "nanoe™ X" will start operating if it is set. After it finishes, the buzzer will beep 6 times and the display will turn off.
  - (FMK16 only) The display will turn off if the "nanoe™ X" is not set.
- Wait at least 30 minutes after the operation is complete before removing the tableware. (The high temperature inside the dishwasher may cause burns.)

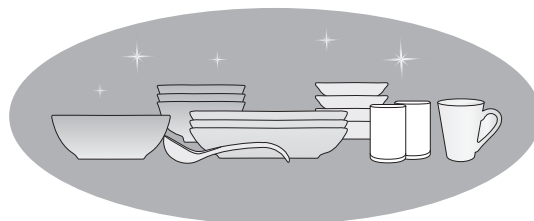

#### Note

- (FMK16 only) If "nanoe™ X" is turned off, remove tableware and food residue in time. (It may cause mold and odours.)
- Clean the filter as necessary. (Page 18)

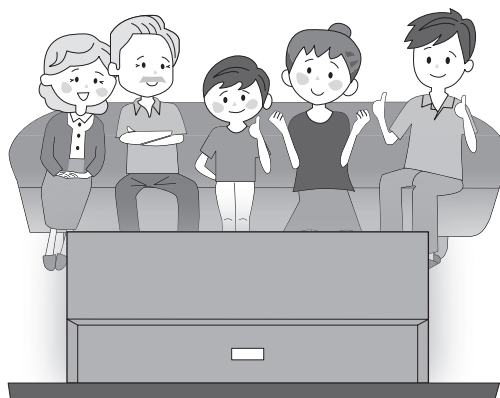

# Loading Tableware

## ■ Cutlery tray

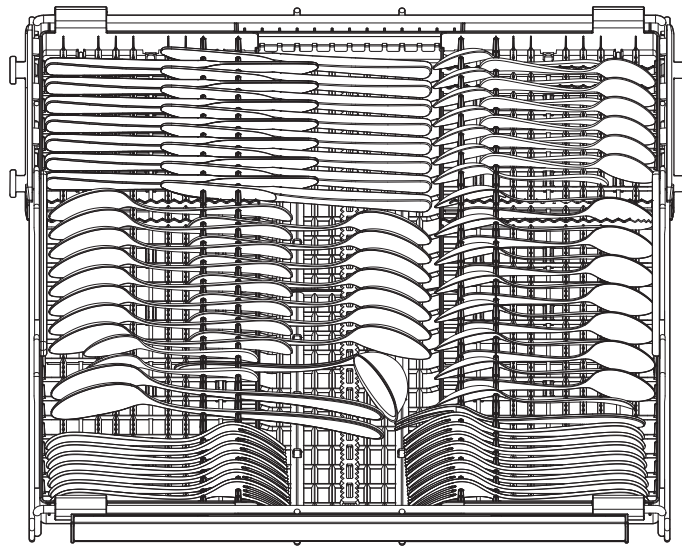

( Cutlery tray loading schematic )

## slidable tray

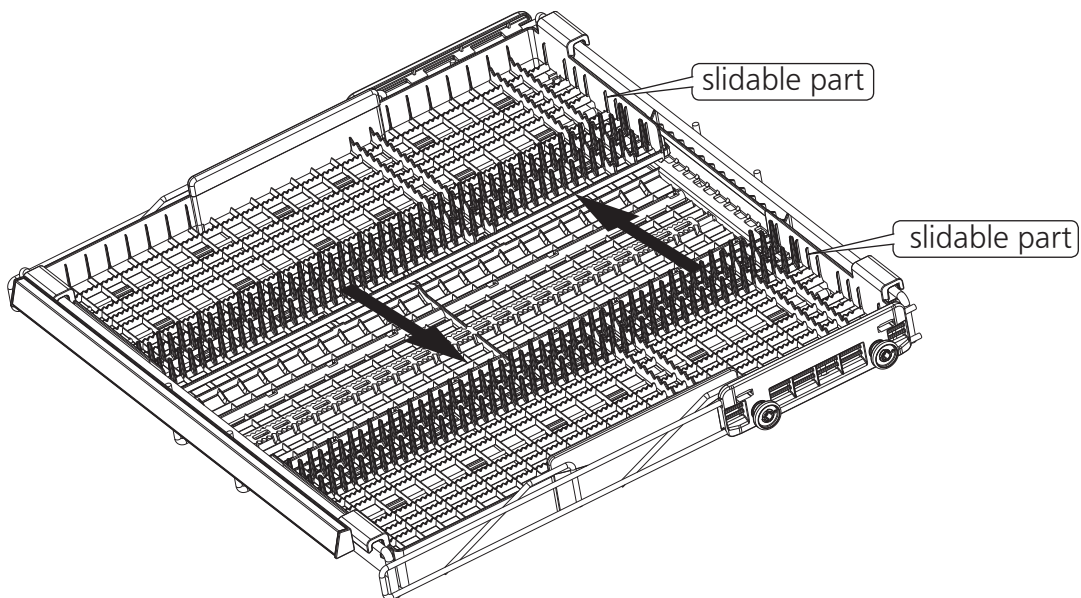

### Note

- The slidable parts can be moved to left or right to create space for loading tableware into the upper basket.

## ■ Upper basket

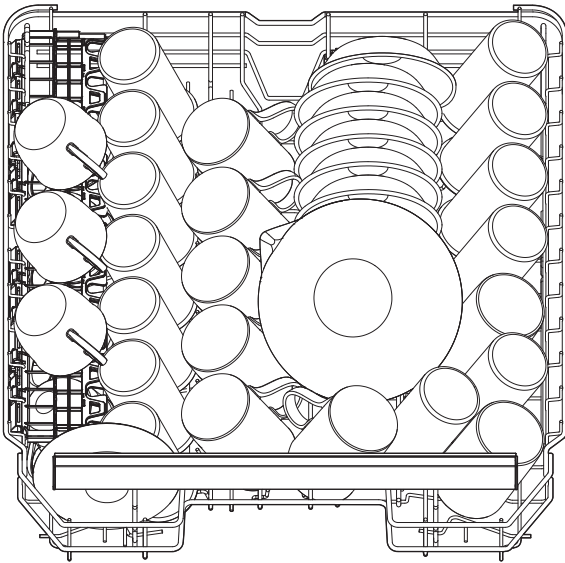

( Upper basket loading schematic )

### Foldable tines (FMK16 only) and foldable cup holder

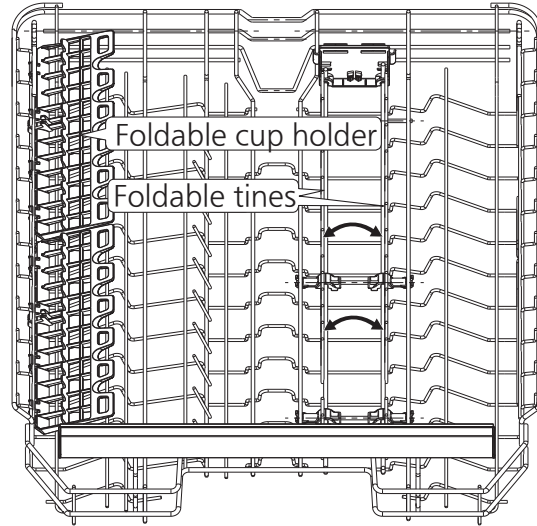

### Height adjustment of the upper basket (3 levels)

- Press the levers on both sides inward at the same time to lower the upper basket.
- Lift the upper basket upwards to raise it. (No need to press the levers.)

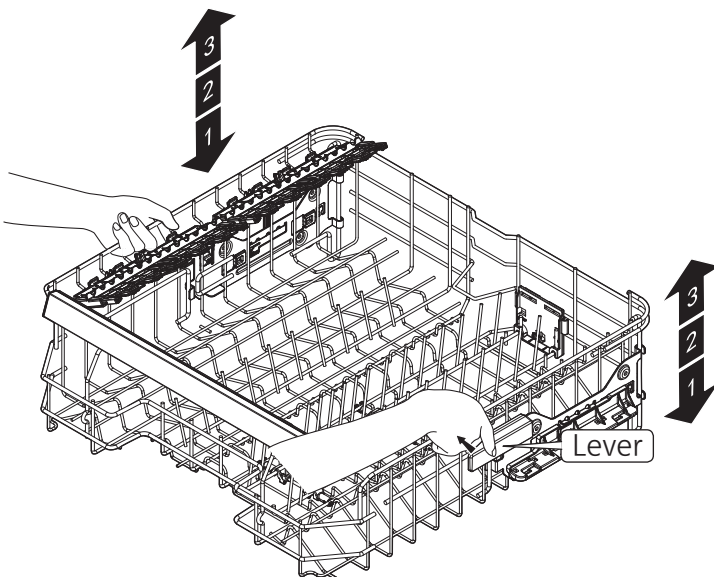

### Foldable cup holder

- Place the wine glass upside down with its stem in the cup holder groove.
- For a better drying results, keep the cup holder at a large tilt angle.

### Foldable cup holder

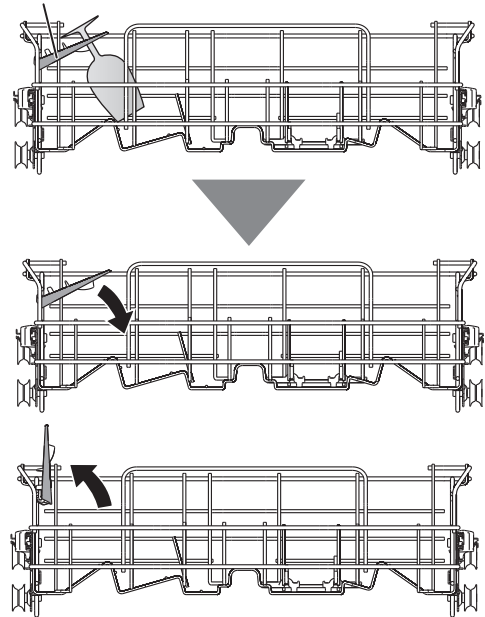

### Notes

- The foldable tines can hold cups or dessert bowls when standing upright and other bowls or utensils when laid down.

# Loading Tableware

## ■ Lower basket

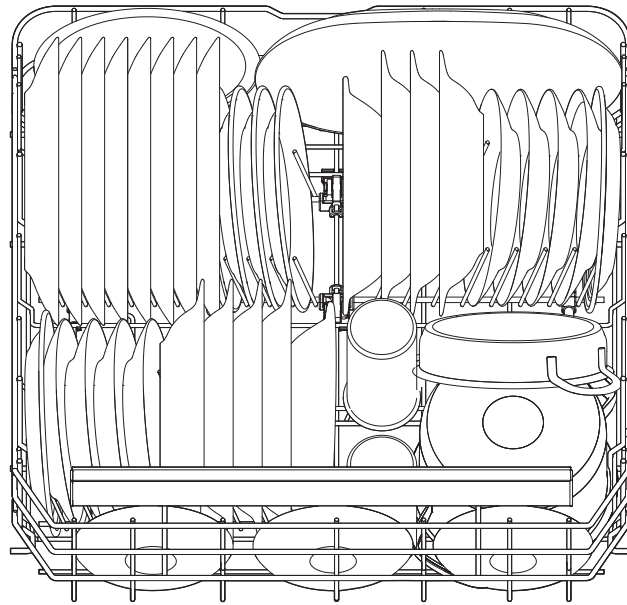

(Lower basket loading schematic)

### Foldable tines (FMK16 only)

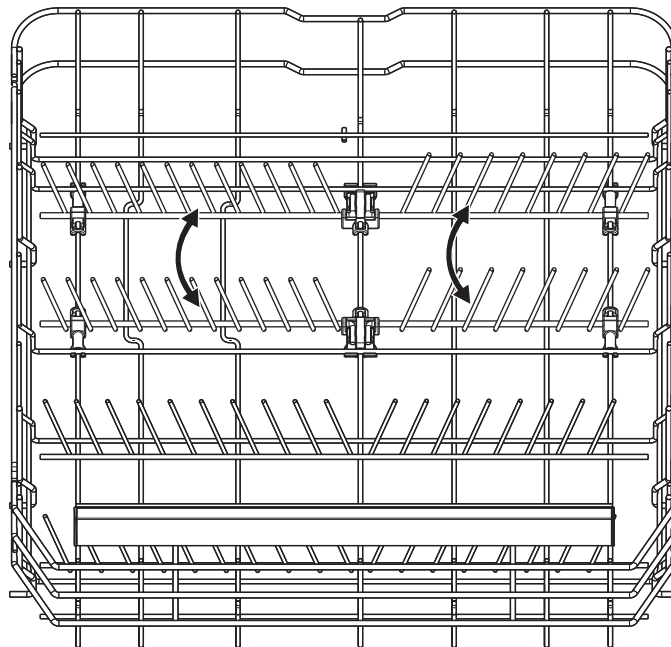

### Notes

- The foldable tines can hold dinner plates when standing upright and large utensils when laid down.



Observe the following to prevent problems when opening and closing the door. (It may cause steam leakage, water leakage, breakage and deformation of the dishwasher interior and tableware, poor washing, etc.)

- Do not overload
- Do not stack the tableware
- Keep bowls and plates facing inward

**Ensure that no tableware protrudes or touches the edges of the dishwasher.**

- Do not load cutting boards on the cutlery tray or on top of tableware.
- Bowls or cups should be loaded with the rim facing downward.
- Make sure the stained side faces inward.
- Avoid placing items that are too tall in the lower basket, to ensure smooth operation of the upper spray arm .
- Do not stack the tableware. (It may not clean well)
- Do not let the handles of pots or pans hang below the basket .(They may block the spray arm and lead to poor washing results.)
- The sharp points of kitchen knives must not touch the metal part of the baskets. (Risk of damage to the appliance.)

#### Note

- Improper loading may damage tableware, deform the dishwasher tub, or prevent the door from opening properly, which may result in water leakage, steam burns and other issues.
  - If the door does not open, do not attempt to force it. Please contact after-sales service.
  - If the appliance becomes deformed, stop using it. Please disconnect the power supply and contact after-sales service.

# Detergent

## Detergent Filling Position

- Dishwasher detergent, rinse aid and dishwasher salt should be filled in the correct positions to avoid affecting the cleaning results.

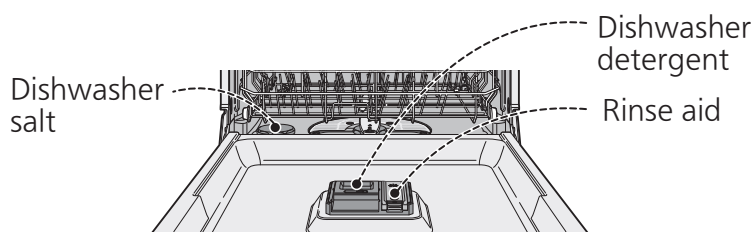

### Dishwasher salt (Water softener)

Use the supplied water hardness test strip to determine the hardness of tap water. If the water hardness is high, white scale may deposit on tableware, baskets or other parts in the dishwasher interior. This appliance is equipped with a water softening system that uses dishwasher salt to adjust water hardness level and ensure optimal cleaning results.

- Adjust the following settings according to the water hardness. Failure to do so may result in excessive use of salt and water, or poor cleaning results.

#### Water hardness setting (with power on)

- Press and hold the **Delay Start** button and **Programs** button at the same time. After the "beep" sound, start the setting.
- Press the **Delay Start** button and select code "1".
- Press the **Dry** button to select the option code.
- Press **Start/Stop** button to save the setting, the display turns off after 6 beeps.

Function code (Press the Delay Start button)	Option code (water hardness) (Press the Dry button)	Display
1	0	Below 120 [mg/L]
	1	120 ~ 180 [mg/L]
	2	180 ~ 250 [mg/L]
	3	250 ~ 425 [mg/L]
	4	425 ~ 500 [mg/L]
		1-2 (Factory setting)

#### Adding dishwasher salt (with power off)

- After lifting the lower basket, press down on the lid and rotate it in the direction shown in the illustration.

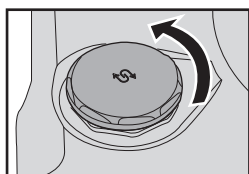

- Add the dishwasher salt using the salt cup (do not spill) and stir well. You can add up to approximately 700 g at most.

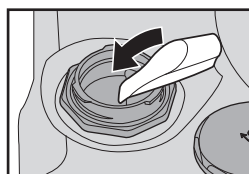

- Close the lid tightly.

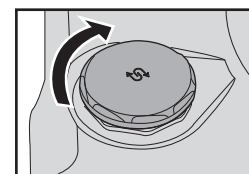

- Fill with water for first-time use (approx. 500 g).

#### Note

- The salt can be weighed with a scale first. If salt is accidentally spilled, please wipe off any salt around the salt container opening. (To avoid friction with the lid and resulting in poor sealing performance.)
- Use only dishwasher salt (do not use table salt, etc.). Read the precautions of the salt carefully and use it in accordance with the instructions.
- If using dishwasher detergent containing dishwasher salt, please read the instructions of the detergent carefully to confirm whether the dishwasher salt needs to be added.
- Add dishwasher salt before operating the appliance. (Spilled salt solution may cause corrosion inside the dishwasher.)

## Detergent

① Move the lever on the lid to the right to open.

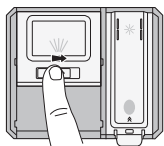

② Add detergent as needed.

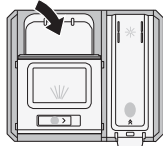

③ Push the lid upwards and close it tightly.

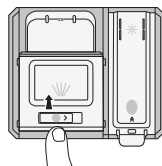

### Note

- Please read the precautions of the detergent you have purchased carefully and use it in accordance with the instructions.

## Rinse aid

The rinse aid for dishwashers effectively minimizes water spots on tableware and dishwasher interior. When ✱ lights up on the display, it indicates that the rinse aid is low (1 or 2 use remaining). Please add it in time.

### ■ Set whether or not to use rinse aid.

(It can be set to "Use" or "Not use" as desired when the power is turned on.)

- 1 Press and hold the **Delay Start** button and **Programs** button at the same time. After the "beep" sound, start the setting.
- 2 Press the **Delay Start** button and select code "2".
- 3 Press the **Dry** button to select the option code.
- 4 Press the **Start/Stop** button to save the setting, the display turns off after 6 beeps.

Function code (Press the Delay Start button)	Option code (Press the Dry button)	Display
2	0	Not use 2-0
	1	Use 2-1 (Factory setting)

### ■ Add the rinse aid

① Press the latch on the lid and open it.

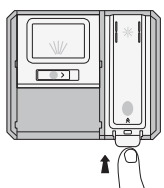

② Add the rinse aid.

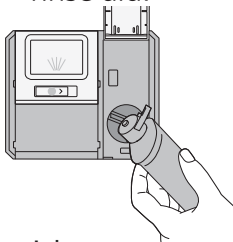

③ Close the lid.

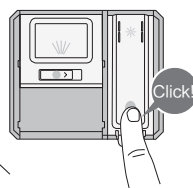

### Note

- Please read the precautions of the rinse aid you have purchased carefully and use it in accordance with the instructions.
- Water droplets will remain if the rinse aid is not used.
- A large amount of foam may be produced when the rinse aid leaks out.  
→ If it is spilled, please wipe it thoroughly and run the "Intensive" program.
- The amount of rinse aid to be dispensed can be adjusted according to the actual cleaning result.

### ■ Adjustment of the rinse aid usage

#### Turn on the power

- 1 Press and hold the **Delay Start** button and **Programs** button at the same time. After the "beep" sound, start the setting.
- 2 Press the **Delay Start** button and select code "4".
- 3 Press the **Dry** button to select the option code.
- 4 Press the **Start/Stop** button to save the setting, the display goes out after 6 beeps.

Function code (Press the Delay Start button)	Option code (Press the Dry button)	Display
4	0	2.2 g 4-0
	1	4.4 g 4-1 (Factory setting)
	2	6.6 g 4-2

# Programs and functions

## ■ Programs

(some programs can reach a maximum water temperature of 72 °C).

Program	Dry		Recommended Usage	Program Sequence	Duration*1		
	FMK16	FVK16			FMK16	FVK16	
Express	90 min	120 min	When the tableware that is slightly soiled and has no dried food residue.	Main wash→ Rinse(2 times)→Dry	135 min	165 min	
ECO	120 min	120 min	When washing normally soiled tableware. Suitable to wash immediately after a meal, or when there is less tableware, or when you want to save water and electricity. It is the recommended program for normally soiled tableware at rated dishwasher capacity.	Pre-wash→Main wash(2 times)→ Rinse(2 times)→Dry	302 min	295 min	
Daily	90 min	120 min	When washing normally soiled tableware and washing immediately after meals.	Pre-wash→Main wash(2 times)→ Rinse(2 times)→Dry	235 min	275 min	
Intensive	90 min	120 min	When washing hours after a meal or when dishes are heavily soiled with grease.	Pre-wash→Main wash(2 times)→ Rinse(2 times)→Dry	247 min	287 min	
Sanitize	90 min	120 min	When you want to sanitize at high temperature after hand washing.	Rinse→Dry	116 min	156 min	
Half Load	90 min	120 min	When there is less tableware (e.g. glasses, cups, plates).	Pre-wash→Main wash(2 times)→ Rinse(2 times)→Dry	202 min	242 min	
Self Clean	90 min	120 min	When the dishwasher interior needs to be cleaned.	Main wash→Rinse(2 times)→Dry	178 min	218 min	
FMK16 only	Auto	90 min	—	When washing immediately after meals. It can automatically adjust the cycle according to the degree of soil of the tableware.	Pre-wash→Main wash(2 times)→ Rinse(2 ~ 3 times)→ Dry	206 ~ 274min	—
	Delicate	120 min	—	When washing delicate tableware that is sensitive to high temperatures, such as glassware and cups.	Pre-wash→Main wash(2 times)→ Rinse(2 times)→Dry	244 min	—
	Dry	120 min	—	When you want to dry the tableware after hand washing or warm up the tableware.	Dry	121 min	—

\*1 The above durations are measured at a room temperature of 23 °C ± 2 °C, inlet water temperature of 15 °C ± 2 °C, and the "nanoe™ X" (FMK16 only) is turned on. The actual durations may vary depending on room temperature, water temperature, water hardness, water pressure, and the state of tableware loading.

## ■ Additional functions and changing the settings

### Dry

Press the **Dry** button to adjust the drying time. Each time it is pressed, the drying time changes as follows:

Drying time		Applicable Scenarios
FMK16	FVK16	
90 min (Factory setting)	120 min (Factory setting)	For normal drying.
120 min	150 min	For a lot of tableware, or when you want to achieve a better drying result.
0 min	0 min	Suitable when drying is not needed.
60 min	90 min	For less tableware, or when you want to save time.

- The drying time for the "Dry", "Delicate" and "ECO" programs is fixed and cannot be adjusted using this button.

## Delay Start

After setting up the "Programs" and "Dry"

- Each time the **Delay Start** button is pressed, the start time of the program changes as follows:  
0 h → 1 h → 2 h → ..... → 23 h → 24h  
↑
- Press the **Start/Stop** button to complete the setting.  
(When the setting is finished, the display shows the selected start time.)

## Pre-wash

If you prefer to rinse the tableware by hand before using the dishwasher, you can turn off the pre-wash function to save water and electricity.

### Turn on the power

- Press and hold the **Delay Start** button and **Programs** button at the same time. After the "beep" sound, start the setting.
- Press the **Delay Start** button and select code "3".
- Press the **Dry** button to select the option code.
- Press the **Start/Stop** button to save the setting, the display turns off after 6 beeps.

Function code (Press the Delay Start button)	Option code (Press the Dry button)		Display
3	0	OFF	3-0
	1	ON	3-1 (Factory setting)

## nanoe™ X

(FMK16 only)

Helps keep the dishwasher interior dry, prevents condensation, reduces water droplet residue, helps to remove odours. By circulating air containing nanoe™ X into the dishwasher interior, it suppresses the growth of bacteria and the generation of odour inside the appliance.

- Factory setting of "Automatic nanoe™ X" is "on". It operates continuously for 7 days. The operating duration can be changed according to the followings:

### Turn on the power

- Press and hold the **Delay Start** button and **Programs** button at the same time. After the "beep" sound, start the setting.
- Press the **Delay Start** button and select code "5".
- Press the **Dry** button to select the option code.
- Press the **Start/Stop** button to save the setting, the display turns off after 6 beeps.

Function code (Press the Delay Start button)	Option code (Press the Dry button)		Display
5	7	7 days	5-07 (Factory setting)
	14	14 days	5-14
	21	21 days	5-21
	30	30 days	5-30

### Note

- Due to intermittent air blowing, intermittent noise may be heard.
- At the end of the operation, the power turns off after 6 beeps.
- When this function is turned off, the durations shown in the program chart may change.

# Maintenance



- Wait at least 30 minutes after the operation is complete before performing maintenance. (Risk of burns.)
- Turn off the power before performing maintenance.

## When Necessary — Clean the filter

The filter of this appliance is self-cleaning, please clean it when necessary. Please remove the lower basket before cleaning.

- 1** Turn the filter counterclockwise and remove the filter.

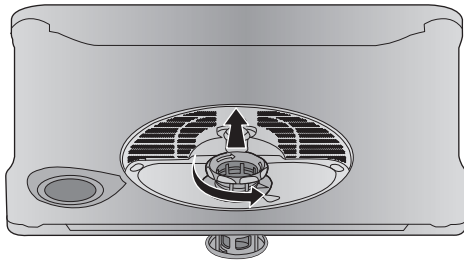

- 2** Disassemble as indicated by the arrows, remove the food residue and clean.
  - Use a brush to remove stubborn stains.

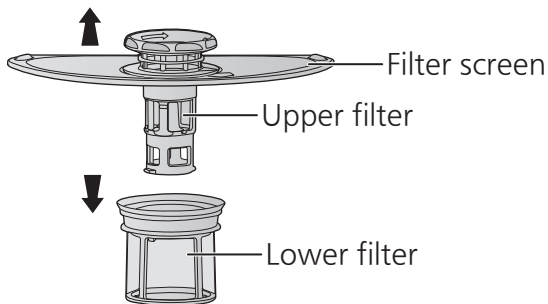

- 3** Clean the grooves under the filter and the bottom of the dishwasher to ensure there are no food residues blocking them.

### Note

- If the filter is clogged, it may lead to a poor cleaning result and could cause mold, unpleasant odours, or water leakage.

- 4** Install the lower filter.
  - Insert the upper filter into the lower filter after aligning the groove on the side of the upper filter with the rib on the lower filter.

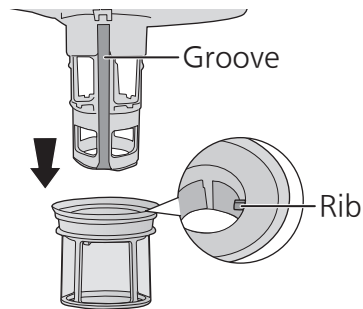

- 5** Install the filter.
  - After placing the filter into the appliance, turn it clockwise. Align the ▲ mark of the upper filter with the ▲ mark of the filter screen.

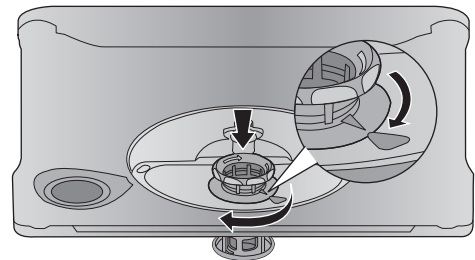

- Do not fill water manually during maintenance. (To avoid water leakage, damage or abnormal alarm.)  
(It is not covered by free warranty in this case.)
- Do not use bleach, detergents, thinner, volatile oils, cleaners, waxes, insecticides, etc. (Risk of damage.)
- When using chemical wipes, follow their instructions.

## Once a month — Clean the body

Wipe all parts of the body with a soft, damp cloth

### The door, the edges, etc.

- The edges of the dishwasher tend to accumulate stains, so please clean them carefully.
- If you are concerned about stains or odour, use dishwasher detergent and run "Self Clean" program without any tableware. Alternatively, use a dishwasher cleaner and follow the product instructions.

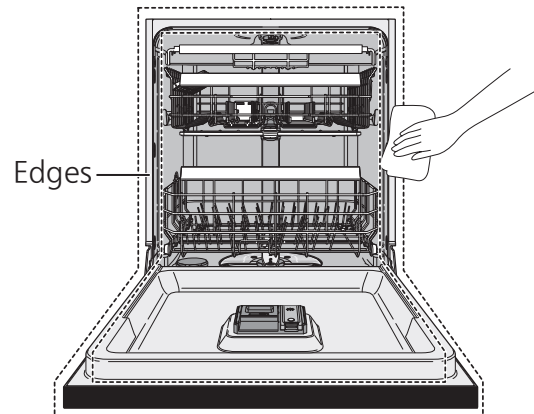
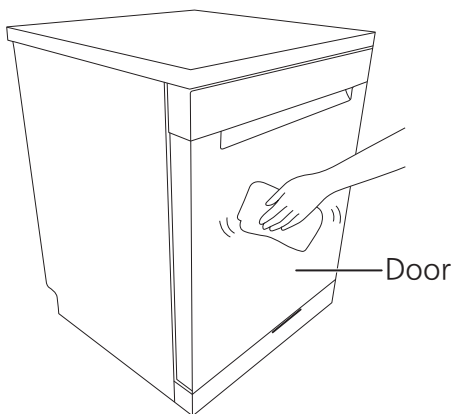

### Spray arms

- Food residues may sometimes adhere to the spray arms and even block the spray holes. Check the spray arms regularly and clean them with a non-metallic brush.

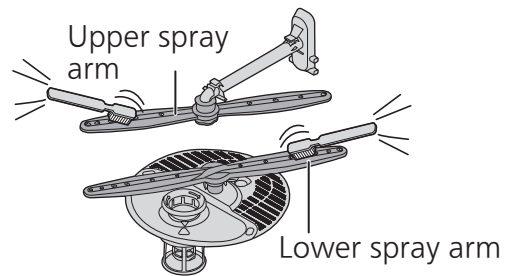

### ■ Removing the spray arm

- Upper spray arm  
Hold the part indicated by the dotted circle, then twist and remove it as shown. To install, tighten it in the opposite direction.
- Lower spray arm  
Pull up the lower spray arm to remove it. Push it down to install.

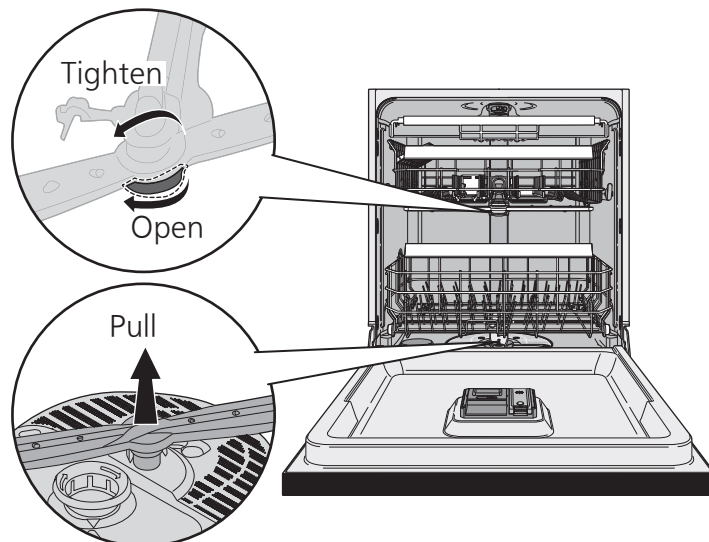

# Maintenance

## When Necessary – Clean the turbidity sensor (FMK16 only)

After removing the filter and the filter screen, wipe the area with a soft cloth.

- This appliance is equipped with a turbidity sensor, which is used by the "Auto" program to make adjustments automatically. If the sensor is dirty, it may affect its ability to function properly.

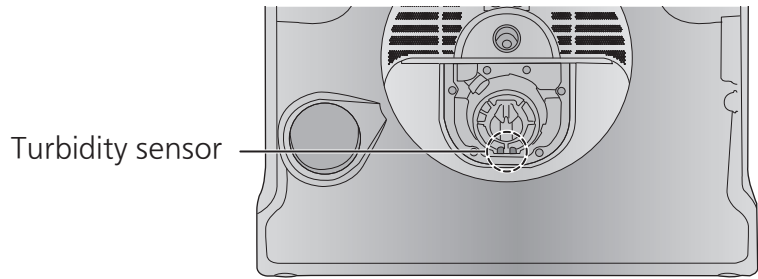

## Preventing freezing / When Not in Use for A Long Time

Turn off the main water valve when the house is vacant for a long time. (Risk of water leakage.)

If there is a risk of freezing, drain the water from the appliance. Failure to do so may result in damage to the water inlet valve and cause water leakage.

→If drainage is needed, please contact after-sales service.

### Conducted by the user

Do not use it when it is frozen.

- 1 When it is frozen, select the "Dry" program and run it 1 or 2 times to defrost.

### Request an after-sales service (When not in use for a long time.)

- After defrosting in accordance with step 1 (skip if not frozen), proceed as follows.

- 2 Close the water inlet valve.

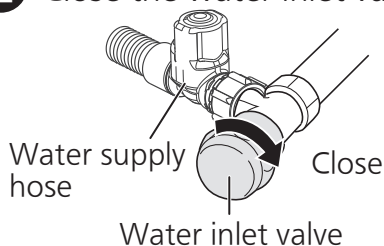

- 3 Place a water tray under the inlet valve, then manually unscrew the water supply hose.

- Do not use a wrench.

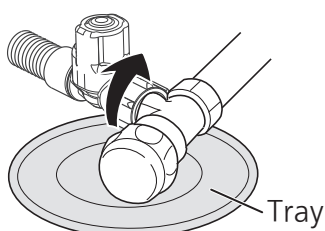

- 4 After turning on the power, press the Start/Stop button.

- 5 Gently shake the water supply hose to let all the water drain out.

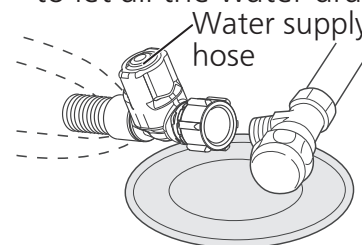

- 6 Turn off the power and empty the water tray.

- 7 Reconnect the water supply hose to the water inlet valve.

- Open the water inlet valve and use the dishwasher only when there is no risk of freezing.

# FAQ

## Poor cleaning results

- Did you use dishwasher detergent, or did you use other unsuitable detergent?  
→Add suitable detergent. (Page 15)
- Is the tableware blocking the spray arms and preventing them from rotating?
- Is the tableware properly loaded?(Pages 10 to 13)
- Did you remove heavy stains before loading?(Page 5)
- Did the water contain a lot of minerals?  
→Please increase the amount of dishwasher detergent appropriately.
- Is the filter clogged?  
→Please clean it. (Page 18)
- Did you check the local water hardness and adjust the setting accordingly?  
→Please adjust the water hardness setting.(Page 14)  
→After setting the water hardness, reset the amount of rinse aid dosage. (Pages 14 to 15)
- Are the spray arms clogged?  
→Please clean the spray arms. (Page 19)
- Tableware still has a food odour after washing.  
→Run the "Daily" or "Intensive" program.

## Undissolved powder detergent remains

- Is the dishwashing powder damp or clumped?  
→If so, please crush them before use.

## Faint watermarks on the glassware

- Is the water hardness high?  
→If the water hardness is high, reset the water hardness setting (Page 14) or rinse aid usage. (page 15)

## The tableware turns yellow or black



- This may be caused by tea stains or chemical reactions of iron components in the water. Please wipe the tableware manually frequently.

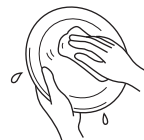

## Glassware turns white or opaque

- Glassware with minor surface imperfections may turn white or opaque after being washed at high temperatures.
- Is there a lot of oil stain on the glass?  
→Please add more dishwasher detergent or run the "Intensive" program.



## Water droplet remains on the bottom of the tableware and inside the dishwasher

- Did you use dishwasher detergent and rinse aid? (Page 15)
- If the bottom of the tableware is concave, water may remain.  
→To reduce water residue, load the tableware slightly tilted, or select a program with longer drying time or extend the drying time. (Page 16).

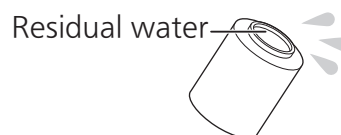

- Is the exhaust outlet located at the bottom front of the unit blocked?  
→Please remove foreign objects or dust from the exhaust outlet. Please contact after-sales service if necessary.

# Troubleshooting



■ Before requesting repairs, please check the following. If the problem cannot be resolved or if symptoms not listed below occur, contact after-sales service.

	Symptom	Points to be checked
The body	Excessive foam is generated inside the dishwasher or at the exhaust outlet.	<ul style="list-style-type: none"> <li>• Were unsuitable detergents used? →Please use only dishwasher detergent. (If dishwashing liquid has been used, leave the dishwasher unused for 1 hour and run the "Daily" program 2 to 3 times.)</li> </ul>
	The sound during operation is too loud.	<ul style="list-style-type: none"> <li>• Is the mesh of the filter screen clogged? →Please turn off the power and clean the filter. (Page 18)</li> <li>• Did you load tableware with too much solid residue? →Please remove food residue before loading. (Page 5)</li> </ul>
	Water droplets remain in the dishwasher interior or around the edges of the dishwasher interior.	<ul style="list-style-type: none"> <li>• Is the drying time too short or has the drying performance been affected by factors such as room temperature?</li> <li>• If water droplets remain, adjust the drying mode or select a program with a longer drying time. (Page 16)</li> </ul>
	Condensation is formed around the exhaust outlet.	<ul style="list-style-type: none"> <li>• It is caused by the hot air released from the exhaust outlet after the final rinse, and it is not a malfunction.</li> </ul>
	There is water leakage around the door.	<ul style="list-style-type: none"> <li>• Are there any solid residues adhering to the rubber seal around the edge? →Please wipe it clean. (Page 19)</li> <li>• Is any tableware protruding from the dishwasher? →Please load the tableware correctly. (Pages 10 to 13)</li> </ul>
	Dishwasher interior becomes white and opaque after a long period of use.	<ul style="list-style-type: none"> <li>• This is caused by mineral content in the water. →Please wipe the dishwasher interior with a soft, damp cloth.</li> </ul>
	There is residual water under the filter.	<ul style="list-style-type: none"> <li>• Residual water at the bottom is normal.</li> </ul>
	Spray arms stop spraying during washing and rinsing	<ul style="list-style-type: none"> <li>• The spray arms temporarily stop during switching. Once the switching is complete, operation resumes. The spray nozzles also pause when the dishwasher detects the water level.</li> </ul>
	Drains water immediately after starting.	<ul style="list-style-type: none"> <li>• It is to drain the residual water inside first, not a malfunction.</li> </ul>
Odours	There is an unpleasant smell when in use.	<ul style="list-style-type: none"> <li>• When just purchased, the rubber and plastic of the appliance may emit a temporary smell. There is no effect on the human body and will disappear after some time.</li> </ul>
	It smells like a sewer.	<ul style="list-style-type: none"> <li>• The smell may result from water residue inside the dishwasher after extended periods of non-use. →Please run the "Daily" or "Self Clean" program.</li> </ul>
	Fishy odour, etc.	<ul style="list-style-type: none"> <li>• This may be caused by food residues, such as fish skin, left on the filter. →Please clean it carefully with a brush. (Page 18)</li> </ul>
Others	Freezing	<ul style="list-style-type: none"> <li>• Run the "Dry" program 1 or 2 times (for defrosting).</li> </ul>
	When the water supply is cut off	<ul style="list-style-type: none"> <li>• Disconnect the power supply and stop the operation. After the water supply is restored, please open other faucets to drain the turbid water in the pipes before using it.</li> </ul>



Symptom		Points to be checked
Others	The drying result is not good.	<ul style="list-style-type: none"> <li>• Were unsuitable detergents or rinse aid used? →Please use dishwasher detergent and dishwasher rinse aid.</li> <li>▶ • Is the exhaust outlet located at the bottom front of the unit blocked? →Please remove foreign objects or dust from the exhaust outlet.</li> </ul>
	When there is a power outage	<ul style="list-style-type: none"> <li>▶ • After the power supply is restored, press the Start/Stop button to resume the program. <ul style="list-style-type: none"> <li>• The program before the power outage will continue.</li> <li>• If the "Delay Start" has been set, it will be cancelled.</li> </ul> </li> </ul>
	The circuit breaker tripped.	<ul style="list-style-type: none"> <li>▶ • Please investigate the cause and restore the circuit breaker, then press the Start/Stop button to resume the program. <ul style="list-style-type: none"> <li>• The program before the circuit breaker tripped will continue.</li> <li>• If the "Delay Start" has been set, it will be cancelled.</li> </ul> </li> </ul>
	After adding dishwasher salt, the display still shows 	<ul style="list-style-type: none"> <li>▶ • After adding dishwasher salt, it takes some time to dissolve, test, etc. (the time may vary each time), so the display also takes some time to go off.</li> </ul>

## Error Code

■ When a malfunction occurs, the error code will appear on the display (the code will flash and an alarm will sound). Please check the following.

Error Code	Cause	Remedy
	Poor water supply	<ul style="list-style-type: none"> <li>• Please turn off the power and make sure that the water inlet valve is open.</li> <li>• Confirm whether the hoses or pipes are frozen. (Page 20)</li> </ul>
	The door is open during operation.	<ul style="list-style-type: none"> <li>• Close the door and restart the operation.</li> </ul>

■ When "H" and two digits appear on the display (the code will flash), please check the following.

	<p>There is a water leakage. →Please close the water inlet valve and contact after-sales service immediately. (Do not cut off the power, otherwise the pump will not operate and cannot forcibly drain water.)</p>
	<p>Poor drainage. →Please turn off the power, clean the filter and remove foreign objects before use. (Page 18) If there are still problems, please contact after-sales service.</p>
	<p>→Please stop using immediately, cut off the power, close the water inlet valve, contact after-sales service and tell them the error code (2 digits after H).</p>

# Specifications

Item	Model	NP-FVK16XE	NP-FMK16XE
Rated voltage and frequency		220-240 V 50/60 Hz	
Rated power input		1720-2030 W	
Dimensions (W × D × H)		600 mm×600 mm×835 mm	
Rated capacity		15 place settings	
Net weight		48 kg	50 kg
Operating range of water pressure		0.05 MPa ~ 1 MPa	

## Power consumption in the following modes:

Power consumption:	in Watts
Sleep	0.5
Stand-by	0.5
Stand-by when connected to network	N/A
Stand-by mode when connected to network with all network ports connected	N/A

## Time required to automatically switch to the following modes:

Time required	in minutes
Sleep	10
Stand-by	10
Stand-by when connected to network	N/A