

Panasonic[®]

Operating Instructions

Premium Design Phone

Model No. **KX-PRS120AZ**

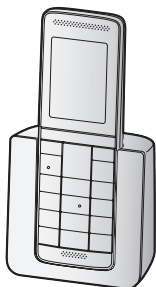

*Before initial use, see “Getting Started”
on page 9.*

Thank you for purchasing a Panasonic product.

Please read these operating instructions before using the unit and save them for future reference.

To use this unit in your country, first change the unit’s region setting to match your country (page 31).

Please access our online customer survey: <http://panasonic.net/pcc/tel/q>

Table of Contents

Introduction		
Accessory information	3	
Important Information		
For your safety	5	
Important safety instructions	7	
For best performance	7	
Other information	7	
Specifications	8	
Getting Started		
Setting up	9	
Controls	10	
Display icons	11	
Turning the power on/off	12	
Language setting	12	
Date and time	12	
Other settings	12	
Making/Answering Calls		
Making calls	14	
Answering calls	14	
Useful features during a call	14	
Intercom	16	
Key lock	16	
Phonebook		
Phonebook	18	
Speed dial	19	
Programming		
Menu list	21	
Alarm	27	
Night mode	27	
Incoming call barring	28	
Baby monitor	29	
Other programming	31	
Registering a unit	33	
Caller ID Service		
Using Caller ID service	35	
Caller list	36	
Answering System		
Answering system	37	
Turning the answering system on/ off	37	
Greeting message	37	
Listening to messages	38	
		Advanced new message alerting features
		39
		Remote operation
		40
		Answering system settings
		41
		Useful Information
		Voice mail service
		44
		Character entry
		44
		Error messages
		46
		Troubleshooting
		47
		Warranty (for New Zealand)
		52
		Index
		Index.....
		53

Accessory information

Supplied accessories

No.	Accessory item/Part number	Quantity
①	AC adaptor/PNLV226AL	1
②	Telephone line cord (for Australia)*1	1
③	Telephone line cord (for New Zealand)	1
④	Rechargeable batteries*2	2
⑤	Handset cover*3	1

*1 The telephone line cord comes connected with the telephone plug.

*2 See page 3 for replacement battery information.

*3 The handset cover comes attached to the handset.



Additional/replacement accessories

Please contact your nearest Panasonic dealer for sales information.

Accessory item	Model number
Rechargeable batteries	HHR-4MY/2B*1
	Battery type: – Nickel metal hydride (Ni-MH) – 2 x AAA (R03) size for each handset
DECT repeater	KX-A405AL
Key finder	KX-TGA20AZ*2

*1 Replacement batteries may have a different capacity from that of the supplied batteries.

*2 By registering the key finder (4 max.) to a Panasonic Digital Cordless Phone and attaching it to an easy-to-lose item in advance, you can locate and find the mislaid item to which the key finder is attached. Please visit our Web site:

<http://panasonic.net/pcc/products/telephone/p/tga20/>

Please contact Panasonic or authorised sales department on the back cover for availability of key finder in your area.

Other information

- Design and specifications are subject to change without notice.
- The illustrations in these instructions may vary slightly from the actual product.

Introduction

Expanding your phone system

Handset (optional): KX-PRSA10AZ

You can expand your phone system by registering optional handsets (6 max.) to a single base unit.

- Optional handsets may be a different colour from that of the supplied handsets.



Important Information

For your safety

To prevent severe injury and loss of life/property, read this section carefully before using the product to ensure proper and safe operation of your product.

WARNING

Power connection

- Use only the power source marked on the product.
- Do not overload power outlets and extension cords. This can result in the risk of fire or electric shock.
- Completely insert the AC adaptor/power plug into the power outlet. Failure to do so may cause electric shock and/or excessive heat resulting in a fire.
- Regularly remove any dust, etc. from the AC adaptor/power plug by pulling it from the power outlet, then wiping with a dry cloth. Accumulated dust may cause an insulation defect from moisture, etc. resulting in a fire.
- Unplug the product from power outlets if it emits smoke, an abnormal smell, or makes an unusual noise. These conditions can cause fire or electric shock. Confirm that smoke has stopped emitting and contact an authorised service centre.
- Unplug from power outlets and never touch the inside of the product if its casing has been broken open.
- Never touch the plug with wet hands. Danger of electric shock exists.

Installation

- To prevent the risk of fire or electrical shock, do not expose the product to rain or any type of moisture.
- Do not place or use this product near automatically controlled devices such as automatic doors and fire alarms. Radio waves emitted from this product may cause such devices to malfunction resulting in an accident.

- Do not allow the AC adaptor or telephone line cord to be excessively pulled, bent or placed under heavy objects.
- It is advised not to use the equipment at a refuelling point. Users are reminded to observe restrictions on the use of radio equipment in fuel depots, chemical plants or where blasting operations are in progress.

Operating safeguards

- Unplug the product from power outlets before cleaning. Do not use liquid or aerosol cleaners.
- Do not disassemble the product.
- Do not spill liquids (detergents, cleansers, etc.) onto the telephone line cord plug, or allow it to become wet at all. This may cause a fire. If the telephone line cord plug becomes wet, immediately pull it from the telephone wall socket, and do not use.

Medical

- Consult the manufacturer of any personal medical devices, such as pacemakers or hearing aids, to determine if they are adequately shielded from external RF (radio frequency) energy. (The product operates in the frequency range of 1.88 GHz to 1.90 GHz, and the RF transmission power is 250 mW (max.).)
- Do not use the product in health care facilities if any regulations posted in the area instruct you not to do so. Hospitals or health care facilities may be using equipment that could be sensitive to external RF energy.

CAUTION

Installation and location

- Never install telephone wiring during an electrical storm.
- Never install telephone line sockets in wet locations unless the socket is specifically designed for wet locations.
- Never touch uninsulated telephone wires or terminals unless the telephone line has been disconnected at the network interface.

Important Information

- Use caution when installing or modifying telephone lines.
- The AC adaptor is used as the main disconnect device. Ensure that the AC outlet is installed near the product and is easily accessible.
- This product is unable to make calls when:
 - the handset batteries need recharging or have failed.
 - there is a power failure.
 - the key lock feature is turned on.

Battery

- We recommend using the batteries noted on page 3. **USE ONLY rechargeable Ni-MH batteries AAA (R03) size.**
- Do not mix old and new batteries.
- Do not open or mutilate the batteries. Released electrolyte from the batteries is corrosive and may cause burns or injury to the eyes or skin. The electrolyte is toxic and may be harmful if swallowed.
- Exercise care when handling the batteries. Do not allow conductive materials such as rings, bracelets, or keys to touch the batteries, otherwise a short circuit may cause the batteries and/or the conductive material to overheat and cause burns.
- Charge the batteries provided with or identified for use with this product only, in accordance with the instructions and limitations specified in this manual.
- Only use a compatible base unit (or charger) to charge the batteries. Do not tamper with the base unit (or charger). Failure to follow these instructions may cause the batteries to swell or explode.

General notices

- This equipment will be inoperable when mains power fails.
- When a failure occurs which results in the internal parts becoming accessible, disconnect the power supply cord immediately and return this unit to an authorised service centre.
- To minimise the possibility of lightning damage, when you know that a thunderstorm is coming, we recommend that you:

- Unplug the telephone line cord from the phone socket.
- Unplug the AC adaptor from the AC power outlet.
- No “000” (for Australia), “111” (for New Zealand), and/or other calls can be made from this device during a mains power failure.
- The earpiece on the handset is magnetised and may retain small metallic objects.

Important notice:

- Under power failure conditions, this telephone may not operate. Please ensure that a separate telephone, not dependent on local power, is available for emergency use.

For New Zealand

- Disconnect the telecom connection before disconnecting the power connection prior to relocating the equipment, and reconnect the power first.
- This equipment shall not be set to make automatic calls to the Telecom “111” Emergency Service.
- The unit’s answering system only responds to Distinctive Alert cadence(s) DA1 and DA3.
- Not all telephones will respond to incoming ringing when connected to the extension socket.
- This equipment may not provide for the effective hand-over of a call to another device connected to the same line.
- The grant of a Telepermit for any item of terminal equipment indicates only that Telecom has accepted that the item complies with minimum conditions for connection to its network. It indicates no endorsement of the product by Telecom, nor does it provide any sort of warranty. Above all, it provides no assurance that any item will work correctly in all respects with another item of Telepermitted equipment of a different make or model, nor does it imply that any product is compatible with all of Telecom’s network services.

Important Information

Important safety instructions

When using your product, basic safety precautions should always be followed to reduce the risk of fire, electric shock, and injury to persons, including the following:

1. Do not use this product near water for example, near a bathtub, washbowl, kitchen sink, or laundry tub, in a wet basement or near a swimming pool.
2. Avoid using a telephone (including a cordless type) during an electrical storm. There may be a remote risk of electric shock from lightning.
3. Do not use the telephone to report a gas leak in the vicinity of the leak.
4. Use only the power cord and batteries indicated in this manual. Do not dispose of batteries in a fire. They may explode. Check with local codes for possible special disposal instructions.

SAVE THESE INSTRUCTIONS

For best performance

Base unit location/avoiding noise

The base unit and other compatible Panasonic units use radio waves to communicate with each other.

- For maximum coverage and noise-free communications, place your base unit:
 - at a convenient, high, and central location with no obstructions between the handset and base unit in an indoor environment.
 - away from electronic appliances such as TVs, radios, personal computers, wireless devices, or other phones.
 - facing away from radio frequency transmitters, such as external antennas of mobile phone cell stations. (Avoid putting the base unit on a bay window or near a window.)
- Coverage and voice quality depends on the local environmental conditions.

- If the reception for a base unit location is not satisfactory, move the base unit to another location for better reception.

Environment

- Keep the product away from electrical noise generating devices, such as fluorescent lamps and motors.
- The product should be kept free from excessive smoke, dust, high temperature, and vibration.
- The product should not be exposed to direct sunlight.
- Do not place heavy objects on top of the product.
- When you leave the product unused for a long period of time, unplug the product from the power outlet.
- The product should be kept away from heat sources such as radiators, cookers, etc. It should not be placed in rooms where the temperature is less than 0 °C or greater than 40 °C. Damp basements should also be avoided.
- The maximum calling distance may be shortened when the product is used in the following places: Near obstacles such as hills, tunnels, underground, near metal objects such as wire fences, etc.
- Operating the product near electrical appliances may cause interference. Move away from the electrical appliances.

Routine care

- **Wipe the outer surface of the product with a soft moist cloth.**
- Do not use benzine, thinner, or any abrasive powder.

Other information

CAUTION: Risk of explosion if battery is replaced by an incorrect type. Dispose of used batteries according to the instructions.

Important Information

Notice for product disposal, transfer, or return

- This product can store your private/confidential information. To protect your privacy/confidentiality, we recommend that you erase information such as phonebook or caller list entries from the memory before you dispose of, transfer, or return the product.

Information on Disposal in other Countries outside the European Union



These symbols are only valid in the European Union. If you wish to discard these items, please contact your local authorities or dealer and ask for the correct method of disposal.

Specifications

- **Standard:**
GAP (Generic Access Profile)
- **Frequency range:**
1.88 GHz to 1.90 GHz
- **RF transmission power:**
Approx. 10 mW (average power per channel)
- **Power source:**
220–240 V AC, 50/60 Hz
- **Power consumption:**
Base unit:
Standby: Approx. 0.6 W
Maximum: Approx. 2.8 W
- **Operating conditions:**
0 °C–40 °C, 20 %–80 % relative air humidity (dry)

Setting up

Connections

■ Base unit

- ① Connect the AC adaptor plug to the unit until you hear a click.
 - ② Fasten the cord by hooking it.
 - ③ Connect the AC adaptor to the power outlet.
 - ④ Connect the telephone line cord to the unit until you hear a click.
 - ⑤ Fasten the cord by hooking it.
 - ⑥ Connect the telephone line cord to the telephone line socket until you hear a click.
 - ⑦ A DSL/ADSL filter (not supplied)*1 is required if you have a DSL/ADSL service.
- *1 For Australia: Connect a DSL/ADSL filter between the telephone plug and telephone line cord.

Note:

- Use only the supplied Panasonic AC adaptor PNLV226AL.
- Use only the supplied telephone line cord.

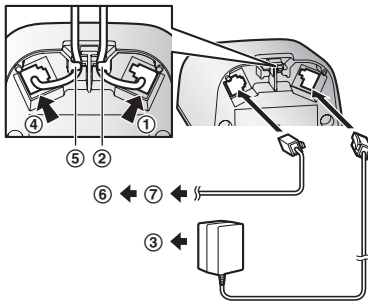

Battery installation

- USE ONLY rechargeable Ni-MH batteries AAA (R03) size (①).
- Do NOT use Alkaline/Manganese/Ni-Cd batteries.

- Confirm correct polarities (⊕, ⊖).

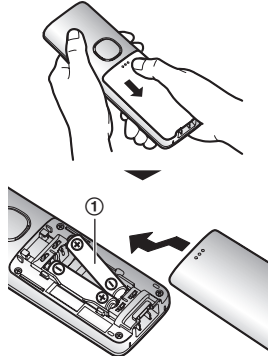

- Follow the directions on the display to set up the unit.

Battery charging

Charge for about 7 hours.

- Confirm "Charging" is displayed (①).
- When the batteries are fully charged, "Fully charged" is displayed.

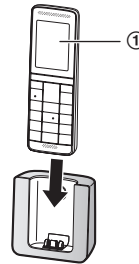

Note when setting up

Note for connections

- The AC adaptor must remain connected at all times. (It is normal for the adaptor to feel warm during use.)
- The AC adaptor should be connected to a vertically oriented or floor-mounted AC

Getting Started

outlet. Do not connect the AC adaptor to a ceiling-mounted AC outlet, as the weight of the adaptor may cause it to become disconnected.

- The unit is not designed to be used with rotary/pulse dialling services.
- The unit's answering system will not answer incoming calls on your FaxAbility number. (for New Zealand)

During a power failure

The unit will not work during a power failure. We recommend connecting a corded-type telephone (without AC adaptor) to the same telephone line or to the same telephone line socket using a telephone double adaptor (for Australia)/a BT double adaptor (for New Zealand).

Note for battery installation

- Use the supplied rechargeable batteries. For replacement, we recommend using the Panasonic rechargeable batteries noted on page 3, 6.

Note for battery charging

- It is normal for the handset to feel warm during charging.
- Clean the charge contacts of the handset, base unit, and charger with a soft and dry cloth once a month. Before cleaning the unit, disconnect from power outlets and any telephone line cords. Clean more often if the unit is exposed to grease, dust, or high humidity.

Battery level

Icon	Battery level
	High
	Medium
	Low
	Needs charging.

Panasonic Ni-MH battery performance (supplied batteries)

Operation	Operating time
In continuous use	12 hours max.
Not in use (standby)	150 hours max.

Note:

- Actual battery performance depends on usage and ambient environment.

Controls

Handset

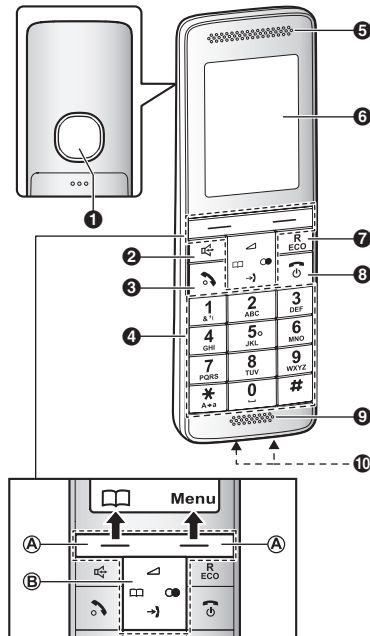

- 1 Speaker
- 2 (Speakerphone)

- 3 (Talk)
- 4 Dial keypad
- 5 Receiver
- 6 Display
- 7 **[R/ECO]**
R: Recall/Flash
ECO: Eco mode shortcut key
- 8 (Off/Power)
- 9 Microphone
- 10 Charge contacts

Control type

A Soft keys

By pressing a soft key, you can select the feature shown directly above it on the display.

B Navigator key

Navigator keys functions as follows.

Symbol	Meaning
	Up
	Down
	Left
	Right

- , , , or : Scroll through various lists and items.
- or (): Adjust the receiver or speaker volume while talking.
- (Caller list): View the caller list.
- (Phonebook): View the phonebook entry.
- (Redial): View the redial list.

Base unit

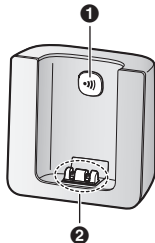







- 1 (Locator)
 - You can locate a misplaced handset by pressing .
- 2 Charge contacts

Display icons

Handset display items

Item	Meaning
	Range status: The more bars visible, the closer the handset is to the base unit.
	Out of base unit range
	Paging, intercom mode
	Speakerphone is on. (page 14)
	The line is in use. <ul style="list-style-type: none"> • When flashing slowly: The call is put on hold. • When flashing rapidly: An incoming call is now being received.
	Missed call*1 (page 35)
	The base unit transmission power is set to "Low". (page 13)
	Noise reduction is set. (page 15)
	The key backlight is off. (page 24)
	<ul style="list-style-type: none"> • When displayed next to the battery icon: Answering system is on. (page 37) • When displayed with a number: New messages have been recorded. (page 38)
	"Greeting Only" is selected. Caller messages are not recorded. (page 43)
	Battery level
	Alarm is on. (page 27)





Getting Started

Item	Meaning
	Equalizer is set. (page 15)
	Privacy mode is on. (page 25)
	Ringer volume is off. (page 23)
	Night mode is on. (page 28)
	Blocked call*1 (page 28)
	New voice mail message received.*2 (page 44)
	Baby monitor is activated. The name/number displayed next to the icon indicates the monitoring unit. (page 29)
Line in use	Someone is using the line.
IN USE	Answering system is being used by another handset.

*1 Caller ID subscribers only

*2 Voice mail subscribers only

Handset soft key icons







Icon	Action
	Temporarily turns off the ringer for incoming calls. (page 14)
	Opens the phonebook.
	Selects entries or handsets. (page 27)
	Erases a number/character.
	Puts the call on mute.

Turning the power on/off

















Press  for about 2 seconds.

Language setting

Display language

- 1 **[Menu]** (right soft key)    
- 2 : Select your desired language. → **[OK]**
- 3 

Date and time



- 1 **[Menu]** (right soft key)    
- 2 Enter the current date, month, and year. → **[OK]**
Example: 15 July, 2013
     
 - You can select the date format by pressing :
 - dd/mm/yy (date/month/year)
 - yy/mm/dd
- 3 Enter the current hour and minute.
Example: 9:30
   
 - You can select 24-hour or 12-hour clock format (“AM” or “PM”) by pressing .
- 4 **[OK]** → 

Other settings

Screen saver mode

The backlight goes dark when on a call or turns off completely after 1 minute of inactivity if the handset is not on the base unit or charger.

Activate the handset display again by:

- pressing  when on a call.
- pressing  at all other times.

One touch eco mode

The **[R/ECO]** button on the handset enables you to activate the eco function with one touch.

By activating eco mode, your unit can reduce the base unit transmission power by up to 90 % in standby mode.

You can turn on/off one touch eco mode by just pressing **[R/ECO]**. The default setting is “**Normal**”.

- When the one touch eco mode is on: “**Low**” is temporarily displayed and **ECO** is shown on the handset display instead of **Y**.
- When the one touch eco mode is off: “**Normal**” is temporarily displayed and **ECO** goes off from the handset display.

Note:

- When there is another cordless phone nearby and it is in use, the base unit transmission power may not be reduced.
- Activating one touch eco mode reduces the range of the base unit in standby mode.
- If you set the DECT repeater mode to “**On**” (page 34):
 - One touch eco mode is cancelled.
 - “**Eco Setup**” is not shown in the display menu (page 24).

Making/Answering Calls

Making calls

- 1 Lift the handset and dial the phone number.
 - To correct a digit, press [C].
- 2 Press [↶].
- 3 When you finish talking, press [↶⏻] or place the handset on the base unit or charger.

Using the speakerphone

- 1 Dial the phone number and press [📞].
- 2 When you finish talking, press [↶⏻].

Note:

- To switch back to the receiver, press [📞]/[↶].

Adjusting the receiver or speaker volume

Press [▲] or [▼] repeatedly while talking.

Making a call using the redial list

The last 10 phone numbers dialled are stored in the redial list (each 24 digits max.).

- 1 [📞]
- 2 [↕]: Select the desired phone number.
- 3 [↶]/[📞]
 - If [📞] is pressed and the other party's line is engaged, the unit automatically redials multiple times.

Erasing a number in the redial list

- 1 [📞]
- 2 [↕]: Select the desired phone number.
→ [Erase]
- 3 [↕]: "Yes" → [OK] → [↶⏻]

Pause (for PBX/long distance service users)

A pause is sometimes required when making calls using a PBX or long distance service. When storing a calling card access number

and/or PIN in the phonebook, a pause is also needed (page 19).

Example: If you need to dial the line access number "0" when making outside calls with a PBX:

- 1 [0] → [▲] (Pause)
- 2 Dial the phone number. → [↶]

Note:

- A 3 second pause is inserted each time [▲] (Pause) is pressed.

Answering calls

- 1 Lift the handset and press [↶] or [📞] when the unit rings.
- 2 When you finish talking, press [↶⏻] or place the handset on the base unit or charger.

Any key answer: You can answer the call by pressing any dial key.

Auto talk: You can answer calls simply by lifting the handset (page 25).

Temporary ringer off: You can turn the ringer off temporarily by pressing [📞].

Adjusting the handset ringer volume

Press [▲] or [▼] repeatedly to select the desired volume while ringing.

Useful features during a call

Hold

- 1 Press [Menu] during an outside call.
- 2 [↕]: "Hold" → [OK]
- 3 To release hold, press [↶].

Note:

- After holding for 10 minutes, the call is disconnected.

Mute

- 1 Press [**M**] during a call.
- 2 To return to the call, press [**M**].

Recall/flash

[**R/ECO**] allows you to use the special features of your host PBX such as transferring an extension call, or accessing optional telephone services.

Note:

- To change the recall/flash time, see page 25.

Handset noise reduction

This feature allows you to hear the voice of the person you are talking to clearly, by reducing the surrounding noise coming from the other party's telephone.

- 1 Press [**M**] while talking.
- 2 [**↕**]: "Noise Reduction On" or "Noise Reduction Off" → [**OK**]

Note:

- Depending on the environment where this handset is being used, this feature may not be effective.
- This feature is not available using the speakerphone.

Handset equalizer

This feature clarifies the voice of the person you are talking to, producing a more natural-sounding voice that is easier to hear and understand.

- 1 Press [**M**] while talking.
- 2 [**↕**]: "Equalizer" → [**OK**]
- 3 [**↕**]: Select the desired setting.
- 4 Press [**OK**] to exit.

Note:

- Depending on the condition and quality of your telephone line, this feature may emphasise existing line noise. If it becomes difficult to hear, turn this feature off.

- This feature is not available while using the speakerphone.

Recording a telephone conversation

Important:

- Before recording a conversation, you should inform the other party that the conversation is to be recorded. In case you record without informing the other party, it will cause the infringement of privacy and civil liability.

- 1 Press [**M**] during an outside call.
- 2 [**↕**]: "Record Call" → [**OK**]
 - A beep is heard and recording starts.
 - A beep sounds every 15 seconds and can be heard by the other party.
- 3 To stop recording, press [**Stop**].

Note:

- To listen to the recorded conversation, see page 38.

For Australia

- All persons using this device for recording telephone conversations shall comply with Australian laws. This requires that at least one party to the conversation is to be aware that it is being recorded. In addition, the principles enumerated in the AustraliaTelecommunications (Interception and Access) Act 1979 shall be complied with in respect to the nature of the personal information collected, the purpose for its collection, how it is used and what is disclosed to any other party.

For New Zealand

- All persons using this device for recording telephone conversations shall comply with New Zealand law. This requires that at least one party to the conversation is to be aware that it is being recorded. In addition, the principles enumerated in the Privacy Act 1993 shall be complied with in respect to the nature of the personal information collected, the purpose for its collection, how it is used and what is disclosed to any other party.

Making/Answering Calls

Call share

You can join an existing outside call. To join the conversation, press [↵] when the other handset is on an outside call.

Note:

- To prevent other users from joining your conversations with outside callers, turn the privacy mode on (page 25).
- Optional handset is required for this function.

Transferring calls, conference calls

Outside calls can be transferred between 2 handsets in the same radio cell. 2 handsets in the same radio cell can have a conference call with an outside party.

- 1 During an outside call, press [Menu] to put the call on hold.
- 2 [↕]: "Intercom" → [OK]
- 3 [↕]: Select the desired unit. → [OK]
- 4 Wait for the paged party to answer.
 - If the paged party does not answer, press [Back] to return to the outside call.
- 5 **To complete the transfer:**
Press [↵].
To establish a conference call:
[Menu] → [↕]: "Conference" → [OK]
 - To leave the conference, press [↵]. The other 2 parties can continue the conversation.
 - To put the outside call on hold: [Menu] → [↕]: "Hold" → [OK]
To resume the conference: [Menu] → [↕]: "Conference" → [OK]
 - To cancel the conference: [Menu] → [↕]: "Stop Conference" → [OK]
You can continue the conversation with the outside caller.

Intercom

Intercom calls can be made between handsets in the same radio cell.

Note:

- When paging the handset, the paged handset beeps for 1 minute.
- If you receive an outside call while talking on the intercom, you hear 2 tones. To answer the call, press [↵], then press [↵].

Making an intercom call

- 1 [Menu] (right soft key) → [Intercom]
- 2 [↕]: Select the desired unit. → [OK]
- 3 When you finish talking, press [↵].

Answering an intercom call

- 1 Press [↵] to answer the page.
- 2 When you finish talking, press [↵].

Turning auto intercom on/off

This feature allows the handset to answer intercom calls automatically when it is called. You do not need to press [↵]. When this feature is set to "On", the monitoring handset for the baby monitor feature (page 30) will also answer baby monitor calls automatically. The default setting is "OFF".

- 1 [Menu] (right soft key) #273
- 2 [↕]: Select the desired setting. → [OK] → [↵]

Key lock

The handset can be locked so that no calls or settings can be made. Incoming calls can be answered, but all other functions are disabled while key lock is on.

To turn key lock on, press [Menu] (right soft key) for about 3 seconds.

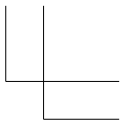
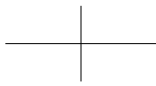
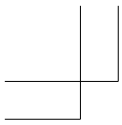

Making/Answering Calls

- To turn key lock off, press **[Key lock]** (right soft key) for about 3 seconds.

Note:

- Calls to emergency numbers cannot be made until key lock is turned off.

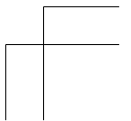
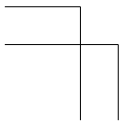
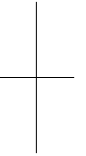
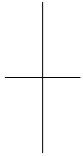

Phonebook

Phonebook

You can add 300 names (16 characters max.) and phone numbers (24 digits max.) to the phonebook, and assign each phonebook entry to the desired category.

The total number of entries that can be stored varies depending on how many phone numbers you have stored for each entry.

Total number of entries is shown below*1:

1 name + 1 phone number: 300 entries

1 name + 2 phone numbers: 150 entries

1 name + 3 phone numbers: 100 entries

*1 Up to 3 phone numbers for each entry can be stored.

Important:

- All entries can be shared by any registered handset.

Adding phonebook entries

- 1 **[□□]** → **[Menu]**
- 2 **[↕]**: “New Entry” → **[OK]**
- 3 **[↕]**: “(Name)” → **[Select]**
- 4 Enter the party’s name. → **[OK]**
 - You can change the character entry mode by pressing **[R/ECO]** (page 44).
- 5 **[↕]**: “(Phone No. 1)” → **[Select]**
 - You can store up to 3 phone numbers for each entry.
- 6 Enter the party’s phone number. → **[OK]**
- 7 **[↕]**: “Category 1” → **[Select]**
- 8 **[↕]**: Select the desired category. → **[OK]**
- 9 **[Save]** → **[↵]**

Note for New Zealand:

- Your service provider/telephone company may charge you for a local call if the number dialled has the area code prefix included. If this is unacceptable, dial only the 7-digit local number. Do not dial the “0” prefix or the area code.

Storing a redial list number to the phonebook

- 1 **[☉]**
- 2 **[↕]**: Select the desired phone number. → **[Detail]** → **[Save]**
- 3 To store the name, continue from step 3, “Editing entries”, page 19.

Storing caller information to the phonebook

- 1 **[→]**
- 2 **[↕]**: Select the desired entry. → **[Detail]** → **[Menu]**
- 3 **[↕]**: “Save CID” → **[OK]**
- 4 **[↕]**: “Phonebook” → **[OK]**
- 5 To store the name, continue from step 3, “Editing entries”, page 19.

Categories

Categories can help you find entries in the phonebook quickly and easily. You can change the names of categories (“Friends”, “Family”, etc.). By assigning different ringer tones for different categories of callers, you can identify who is calling (category ringer tone), if you have subscribed to Caller ID service.

Changing category names/setting category ringer tone

- 1 **[□□]** → **[Menu]**
- 2 **[↕]**: “Category” → **[OK]**
- 3 **[↕]**: Select the desired category. → **[OK]**
- 4 **To change category names**
[↕]: “Category Name” → **[OK]** → Edit the name (10 characters max.; page 44). → **[OK]**
To set category ringer tone
[↕]: Select the current setting of the category ringer tone. → **[OK]** → **[↕]**: Select the desired ringer tone. → **[OK]**
- 5 **[↵]**

Finding and calling from a phonebook entry

- 1 **[□]**
- 2 **To scroll through all entries**
[↕]: Select the desired entry. → **[↶]**
To search by first character
 - ① Press the dial key (**[0]** to **[9]**, or **[#]**) which contains the character you are searching for (page 44).
 - ② **[↕]**: Scroll through the phonebook if necessary. → **[↶]****To search by query**
 - ① **[✕]** → To search for the name, enter the first characters (up to 4) in uppercase (page 44). → **[OK]**
 - ② **[↕]**: Scroll through the phonebook if necessary. → **[↶]****To search by category**
 - ① **[Search]** → **[↕]**: “Category” → **[OK]**
 - ② **[↕]**: Select the desired category. → **[OK]**
 - ③ **[↕]**: Scroll through the phonebook if necessary. → **[↶]**
- 3 **[↕]**: Select the desired phone number. → **[↶]**

Editing entries

- 1 Find the desired entry (page 19). → **[Menu]**
- 2 **[↕]**: “Edit” → **[OK]**
- 3 **[↕]**: Select the desired item you want to change. → **[Select]**
- 4 **To change the name and phone number:**
 Edit the name or phone number. → **[OK]**
To change the category:
[↕]: Select the desired category. → **[OK]**
- 5 **[Save]** → **[↶]**

Erasing entries

Erasing an entry

- 1 Find the desired entry (page 19). → **[Menu]**
- 2 **[↕]**: “Erase” → **[OK]**
- 3 **[↕]**: “Yes” → **[OK]** → **[↶]**

Erasing all entries

- 1 **[□]** → **[Menu]**
- 2 **[↕]**: “Erase All” → **[OK]**
- 3 **[↕]**: “Yes” → **[OK]**
- 4 **[↕]**: “Yes” → **[OK]** → **[↶]**

Chain dial

This feature allows you to dial phone numbers in the phonebook while you are on a call. This feature can be used, for example, to dial a calling card access number or bank account PIN that you have stored in the phonebook, without having to dial manually.

- 1 During an outside call, press **[Menu]**.
- 2 **[↕]**: “Phonebook” → **[OK]**
- 3 **[↕]**: Select the desired entry. → **[Call]**
- 4 **[↕]**: Select the desired phone number.
- 5 Press **[Call]** to dial the number.

Note:

- When storing a calling card access number and your PIN in the phonebook as one phonebook entry, press **[▲]** (Pause) to add pauses after the number and PIN as necessary (page 14).

Speed dial

You can assign 1 phone number to each of the dial keys (**[1]** to **[9]**) on the handset.

Phonebook

Adding phone numbers to speed dial keys

■ By entering phone numbers:

- 1 Press and hold the desired speed dial key ([1] to [9]). → **[Add]**
- 2 [↕]: "Manual" → **[OK]**
- 3 Enter the party's name (16 characters max.; page 44). → **[OK]**
- 4 Enter the party's phone number (24 digits max.). → **[OK]** 2 times → **[↵]**

■ From the phonebook:

- 1 Press and hold the desired speed dial key ([1] to [9]). → **[Add]**
- 2 [↕]: "Phonebook" → **[OK]**
- 3 [↕]: Select the desired entry. → **[OK]**
- 4 [↕]: Select the desired phone number.
- 5 **[OK]** → **[↵]**

Note:

- If you edit a phonebook entry which is assigned to a speed dial key, the edited entry does not transfer to the speed dial key.

Editing an entry

- 1 Press and hold the desired speed dial key ([1] to [9]). → **[Menu]**
- 2 [↕]: "Edit" → **[OK]**
- 3 Edit the name if necessary. → **[OK]**
- 4 Edit the phone number if necessary. → **[OK]** 2 times → **[↵]**

Erasing an entry

- 1 Press and hold the desired speed dial key ([1] to [9]). → **[Menu]**
- 2 [↕]: "Erase" → **[OK]**
- 3 [↕]: "Yes" → **[OK]** → **[↵]**

Viewing an entry/Making a call

- 1 Press and hold the desired speed dial key ([1] to [9]).
- 2 To make a call, press **[↵]**.

Menu list

To access the features, there are 2 methods.

■ Scrolling through the display menus

- 1 **[Menu]** (right soft key)
- 2 Press **[▼]**, **[▲]**, **[▶]**, or **[◀]** to select the desired main menu. → **[OK]**
- 3 Press **[▼]** or **[▲]** to select the desired item from the next sub-menus. → **[OK]**
- 4 Press **[▼]** or **[▲]** to select the desired setting. → **[OK]**

■ Using the direct command code

- 1 **[Menu]** (right soft key) → Enter the desired code.
Example: Press **[Menu]** (right soft key) **#1101**.
- 2 Select the desired setting. → **[OK]**

Note:

- To exit the operation, press **[↶⏻]**.
- In the following table, < > indicates the default settings.
- In the following table,  indicates the reference page number.
- Display menu order and sub-menu may vary depending on your model.

Display the menu tree and direct command code table

Main menu: **→** "Caller List"

Operation	Code	
Viewing the caller list.	#213	36

Main menu: **☎** "Answer System"

Sub-menu 1	Sub-menu 2	Settings	Code	
Message List	–	–	#329	38
Play New Msg.	–	–	#323	38
Play All Msg.	–	–	#324	38
Erase All Msg.* ¹	–	–	#325	39
Greeting	Start REC* ¹ (Record greeting)	–	#302	37
	Play Greeting	–	#303	38
	Default* ¹ (Reset to pre-recorded greeting)	–	#304	37

Programming

Sub-menu 1	Sub-menu 2	Settings	Code	
New Message Alert	Outgoing Call ^{*1} – On/Off	1: On 0: <Off>	#338	39
	Outgoing Call ^{*1} – Notification to	–		
	Outgoing Call ^{*1} – Remote Code	1: Activate 0: <Inactivate>		
	Handset Beep	1: On 0: <Off>	#339	39
Settings	Number of Rings ^{*1}	2-9: 2-9 Rings 5: <5 Rings> 0: Auto	#211	42
	Recording Time ^{*1}	1: 1 Minute 3: <3 Minutes> 0: Greeting Only ^{*2}	#305	42
	Remote Code ^{*1}	–	#306	40
	Call Screening	1: <On> 0: Off	#310	41
Answer On ^{*1}	–	–	#327	37
Answer Off ^{*1}	–	–	#328	37

Main menu: “Ringer Setup”

Sub-menu 1	Sub-menu 2	Settings	Code	
Ringer Volume	–	0-6: Off-6 <6>	#160	–
Ringtone ^{*3}	–	<Ringtone 1>	#161	–
Night Mode	On/Off	1: On 0: <Off>	#238	28
	Start/End	<23:00/06:00>	#237	28
	Ring Delay	1: 30 sec. 2: <60 sec.> 3: 90 sec. 4: 120 sec. 0: No Ringing	#239	28
	Select Category	1-9: Category 1-9	#241	28
First Ring ^{*1, *4}	–	1: <On> 0: Off	#173	–

Main menu: “Intercom”

Operation	Code	
Paging the desired unit.	#274	16

Programming

Main menu:  "Time Settings"

Sub-menu 1	Sub-menu 2	Settings	Code	
Set Date/Time* ¹	–	–	#101	12
Memo Alarm	1-5: Alarm1-5	1: Once 2: Daily 3: Weekly 0: <Off>	#720	27
Time Adjustment* ^{1, *5}	–	1: <Caller ID> 0: Manual	#226	–

Main menu:  "Initial Setup"

Sub-menu 1	Sub-menu 2	Settings	Code	
Ringer Setup	Ringer Volume	0-6: Off-6 <6>	#160	–
	Ringtone* ³	<Ringtone 1>	#161	–
	Night Mode – On/Off	1: On 0: <Off>	#238	28
	Night Mode – Start/End	<23:00/06:00>	#237	28
	Night Mode – Ring Delay	1: 30 sec. 2: <60 sec.> 3: 90 sec. 4: 120 sec. 0: No Ringing	#239	28
	Night Mode – Select Category	1-9: Category 1-9	#241	28
	First Ring* ^{1, *4}	1: <On> 0: Off	#173	–
Time Settings	Set Date/Time* ¹	–	#101	12
	Memo Alarm – 1-5: Alarm1-5	1: Once 2: Daily 3: Weekly 0: <Off>	#720	27
	Time Adjustment* ^{1, *5}	1: <Caller ID> 0: Manual	#226	–
Handset Name	–	–	#104	31

Programming

Sub-menu 1	Sub-menu 2	Settings	Code		
Key Finder Setup ^{*6} - 1: Add new device (for Finder1) ^{*7} - 2: Add new device (for Finder2) - 3: Add new device (for Finder3) - 4: Add new device (for Finder4)	Change Name ^{*1}	Finder1	#6561	-	
		Finder2 ^{*8}	#6562 ^{*9}	-	
		Finder3 ^{*8}	#6563 ^{*9}	-	
		Finder4 ^{*8}	#6564 ^{*9}	-	
	Register	-		#6571	-
				#6572 ^{*9}	-
				#6573 ^{*9}	-
				#6574 ^{*9}	-
	Cancel Register	-		#6581	-
				#6582 ^{*9}	-
				#6583 ^{*9}	-
				#6584 ^{*9}	-
Caller Barred ^{*1}	-	-	#217	28	
Speed Dial	-	-	#261	19	
Eco Setup	Transmission Power ^{*1}	1: <Normal> 2: Low	#725	13	
Display Setup	Wallpaper	<Wallpaper1>	#181	-	
	Clock ^{*10}	1: Analogue (Small)	#198	-	
		2: Analogue (Large)			
		3: <Digital (Large)>			
		4: Digital (Small)			
	0: Off				
	Display Colour	1: <Colour1> 2: Colour2	#182	-	
Display Mode ^{*11}	1: <Multi Items> 0: Single Item	#192	-		
Key Backlight	1: <On> 0: Off	#276	-		
LCD in charging ^{*12} (LCD backlight)	1: <On> 0: Off	#191	-		
Contrast (Display contrast)	1-6: Contrast 1-6 <Contrast 3>	#145	-		
Auto Intercom	-	1: On 0: <Off>	#273	16	

Programming

Sub-menu 1	Sub-menu 2	Settings	Code	
Keytones	-	1: <On> 0: Off	#165	-
Area Code ^{*1}	-	-	#255	31
Call Restrict ^{*1}	-	-	#256	31
Auto Talk ^{*13}	-	1: On 0: <Off>	#200	14
Line Setup	Recall/Flash ^{*1, *14, *15}	0: 900 msec. 1: 700 msec. 2: 600 msec. 3: 400 msec. 4: 300 msec. 5: 250 msec. *: 200 msec. #: 160 msec. 6: 110 msec. 7: <100 msec.> 8: 90 msec. 9: 80 msec.	#121	15
Privacy Mode ^{*1, *16}	-	1: On 0: <Off>	#194	-
Base Unit PIN ^{*1}	-	<0000>	#132	31
DECT Repeater ^{*1}	-	1: On 0: <Off>	#138	34
Register	Register H.set	-	#130	33
	Cancel Register ^{*2}	-	#131	33
Country ^{*1}	-	1: <Australia> 2: <NewZealand>	#136	31
Select Base	-	<Auto>	#137	33
Cancel Base ^{*2}	-	-	#139	33
Language	Display	<English>	#110	12

Main menu:  "Baby Monitor"

Sub-menu 1	Sub-menu 2	Settings	Code	
On/Off	-	1: On 0: <Off>	#268	29
Sensitivity Level	-	1: Low 2: <Middle> 3: High	#269	30

Programming

Main menu:  "Calendar"

Operation	Code	
Viewing the calendar and setting the schedule alarm.	#727	32

Main menu:  "Key Finder"^{*6}

Sub-menu 1	Sub-menu 2	Settings	Code	
Search	–	–	#655	–
Battery Check	–	–		

Main menu:  "Caller Barred"^{*1, *17}

Operation	Code	
Storing/Viewing bar call numbers.	#217	28

- *1 If you program these settings using one of the handsets, you do not need to program the same item using another handset.
- *2 This menu is not displayed when scrolling through the display menus. It is only available in direct command code.
- *3 The preset melodies in this product ("Ringtone 3" - "Ringtone 40") are used with permission of © 2012 Copyrights Vision Inc.
- *4 If you do not want the unit to ring before the caller information is received, set to "Off". (Caller ID subscribers only)
You can only remove the first ring if the unit rings 2 times or more by default, which depends on your service provider/telephone company.
- *5 This feature allows the unit to automatically adjust the date and time each time caller information including date and time is received.
To turn this feature on, select "Caller ID". To turn this feature off, select "Manual". (Caller ID subscribers only)
To use this feature, set the date and time first (page 12).
- *6 This setting is available when you have the key finder (KX-TGA20AZ). Read the installation manual for more information on the key finder.
- *7 For models with supplied key finders, the display shows "1: Finder1".
- *8 If you register 2 or more key finders.
- *9 If you have 2 or more key finders.
- *10 Wallpaper is displayed in the standby mode only when you select "Digital (Small)" or "Off" for this setting.
- *11 You can select to display either a single item or multiple items on one screen at a time for the handset main menu icons in function menu, recorded message list, phonebook list, caller list, and redial list.
- *12 You can set the handset display backlight while on charge.
 - "On": Backlight is on (dimmed).
 - "Off": Backlight turns off after 10 seconds of charging.
- *13 If you subscribe to a Caller ID service and want to view the caller's information after lifting up the handset to answer a call, turn off this feature.
- *14 The recall/flash time depends on your telephone exchange or host PBX. Contact your PBX supplier if necessary.

Programming

- You can access your service provider/telephone company "call waiting" service by having the recall/flash time set at "100 msec.", and then follow your service provider/telephone company "call waiting" instructions to operate this service. (for Australia)
- *15 The default setting will be as follows if you select the following regional codes when changing the unit's region setting (page 31):
"NewZealand" = "600 msec."
- *16 To prevent other users from joining your conversations with outside callers, turn this feature on.
- *17 This menu icon is displayed when the key finder is not registered.

Alarm

An alarm sounds at the set time for 1 minute and is repeated 5 times at 5 minute intervals (snooze function). A text memo can also be displayed for the alarm. A total of 5 separate alarm times can be programmed for each handset. You can set one of 3 different alarm options (once, daily, or weekly) for each alarm time.

Important:

- Make sure the unit's date and time setting is correct (page 12).

- 1 **[Menu]** (right soft key) **[#][7][2][0]**
- 2 Select an alarm by pressing **[1]** to **[5]**. → **[OK]**
- 3 **[↕]**: Select the desired alarm option. → **[OK]**

"Off" Turns alarm off. Go to step 9.
"Once" An alarm sounds once at the set time.
"Daily" An alarm sounds daily at the set time. Go to step 5.
"Weekly" Alarm sounds weekly at the set time(s).

- 4 Proceed with the operation according to your selection in step 3.
 - **Once:**
Enter the desired date and month. → **[OK]**

■ Weekly:

- [↕]**: Select the desired day of the week and press **[✓]**. → **[OK]**
- 5 Set the desired time. → **[OK]**
 - 6 Enter a text memo (30 characters max.). → **[OK]**
 - 7 **[↕]**: Select the desired alarm tone. → **[OK]**
 - We recommend selecting a different ringer tone from the one used for outside calls.
 - 8 **[↕]**: Select the desired snooze setting. → **[OK]**
 - 9 **[OK]** → **[↶⏻]**

Note:

- Press **[Stop]** to stop the alarm completely.
- When the handset is in use, the alarm will not sound until the handset is in standby mode.
- Press any dial key or **[Snooze]** to stop the sound but keep the snooze function activated.
- If you want to make an outside call when the snooze function is activated, please stop the snooze function before making the call.

Night mode

Night mode allows you to select a period of time during which the handset will not ring for outside calls. This feature is useful for time periods when you do not want to be disturbed, for example, while sleeping. Night mode can be set for each handset.

Programming

Important:

- Make sure the unit's date and time setting is correct (page 12).
- If you have set the alarm, the alarm sounds even if the night mode is turned on.

Turning night mode on/off

- 1 **[Menu]** (right soft key) [#]2[3]8
- 2 **[↓]**: Select the desired setting. → **[OK]**
 - If you select “**OFF**”, press **[↶]** to exit.
- 3 Enter the desired hour and minute you wish to start this feature. → **[OK]**
- 4 Enter the desired hour and minute you wish to end this feature. → **[OK]** → **[↶]**

Changing the start and end time

- 1 **[Menu]** (right soft key) [#]2[3]7
- 2 Continue from step 3, “Turning night mode on/off”, page 28.

Setting the ring delay

This setting allows the handset to ring during night mode if the caller waits long enough. After the selected amount of time passes, the handset rings. If you select “**No Ringing**”, the handset never rings during night mode.

- 1 **[Menu]** (right soft key) [#]2[3]9
- 2 **[↓]**: Select the desired setting. → **[OK]** → **[↶]**

Note:

- When the answering system answers the call, this feature does not work.

Selecting categories to bypass night mode

- 1 **[Menu]** (right soft key) [#]2[4]1
- 2 Select your desired categories by pressing **[1]** to **[9]**.
 - “**✓**” is displayed next to the selected category numbers.

- To cancel a selected category, press the same dial key again. “**✓**” disappears.

- 3 **[OK]** → **[↶]**

Incoming call barring

This feature allows the unit to reject calls from specified phone numbers that you do not want to answer such as junk calls.

When a call is received, the unit does not ring while the caller is being identified. If the phone number matches an entry in the call barred list, the unit emits no sound to the caller, and disconnects the call. (Caller ID subscribers only)

Important:

- When the unit receives a call from a number that is stored in the call barred list, the call is logged in the caller list (page 36) with **X** after the call is disconnected.

Storing unwanted callers

You can store up to 100 phone numbers in the call barred list.

Important:

- You must store the phone number with an area code in the call barred list.

■ From the caller list:

- 1 **[→]**
- 2 **[↓]**: Select the entry to be barred. → **[Detail]** → **[Menu]**
- 3 **[↓]**: “**Save CID**” → **[OK]**
- 4 **[↓]**: “**Caller Barred**” → **[OK]**
- 5 **[↓]**: “**Yes**” → **[OK]** → **[↶]**

■ By entering phone numbers:

- 1 **[Menu]** (right soft key) [#]2[1]7 → **[Add]**
- 2 Enter the phone number (24 digits max.). → **[OK]**
- 3 **[↶]**

Viewing/editing/erasing bar call numbers

- 1 **[Menu]** (right soft key) **#217**
- 2 **[↓]**: Select the desired entry.
 - To exit, press **[↶]**.
- 3 **To edit a number:**
[Edit] → Edit the phone number. →
[OK] → **[↶]**
To erase a number:
[Erase] → **[↓]**: “Yes” → **[OK]** →
[↶]

Baby monitor

This feature allows you to listen in on a room where another handset is located, allowing you to easily monitor from different areas of the house or place. The monitored handset (placed in a baby’s room, for example) will automatically call the monitoring handset or the phone number stored when it detects sound.

Important:

- You should perform a test run of the baby monitor procedure to ensure that the baby monitor feature is set correctly. For example, test its sensitivity. Check the connection if you are diverting the baby monitor to an outside line.

Note:

- Both the monitored and monitoring handsets must select the same base unit in order to use the baby monitor feature (page 33).
- If the unit is connected to a PBX system, you cannot set the baby monitor.
- During the monitoring mode, battery consumption is faster than usual. We recommend leaving the monitored handset on the base unit or charger.
- The monitored handset never rings during the monitoring mode.

Setting the baby monitor

Perform the setting operation with the handset to be monitored (for example, the handset placed in a baby’s room).

To monitor with a handset

The internal baby monitor feature is only available between handsets in the same radio cell.

- 1 **[Menu]** (right soft key) **#268**
- 2 **[↓]**: “On” → **[OK]**
- 3 **[↓]**: Select the desired handset number to monitor with. → **[OK]**
 - “Baby Monitor” will be displayed.
 - The registered handset name/number is displayed.

Note:

- When this feature is on, another handset can hear the monitored handset by making an intercom call.

To monitor from an outside line

■ From the phonebook:

- 1 **[Menu]** (right soft key) **#268**
- 2 **[↓]**: “On” → **[OK]**
- 3 **[↓]**: Select “External” to monitor from an outside line. → **[Edit]** → **[Add]**
- 4 **[↓]**: “Phonebook” → **[OK]**
- 5 **[↓]**: Select the phonebook entry. → **[OK]**
- 6 **[↓]**: Select the desired phone number. → **[OK]**
 - “Baby Monitor” will be displayed.

Note:

- If you edit a phonebook entry which is assigned for monitoring, the edited entry does not transfer to the monitor.

■ By entering phone numbers:

- 1 **[Menu]** (right soft key) **#268**
- 2 **[↓]**: “On” → **[OK]**

Programming

- 3 [↕]: Select "External" to monitor from an outside line. → [Edit] → [Add]
- 4 [↕]: "Manual" → [OK]
- 5 Enter the desired name. → [OK]
- 6 Enter the desired number. → [OK] 2 times
 - "Baby Monitor" will be displayed.

Note:

- The registered name/number is displayed.

Turning off the baby monitor

The monitored handset cannot be used while baby monitor is set to "On".

- 1 Press [Menu] on the handset being monitored.
- 2 [↕]: "On/Off" → [OK]
- 3 [↕]: "Off" → [OK] → [↵]

Editing an outside monitoring number

- 1 Press [Menu] on the handset being monitored.
- 2 [↕]: "On/Off" → [OK]
- 3 [↕]: "On" → [OK]
- 4 [↕]: Select the outside line. → [Edit]
- 5 [Menu] → [↕]: "Edit" → [OK]
- 6 Edit the name if necessary. → [OK]
- 7 Edit the phone number if necessary. → [OK] 2 times

Erasing an outside monitoring number

- 1 Press [Menu] on the handset being monitored.
- 2 [↕]: "On/Off" → [OK]
- 3 [↕]: "On" → [OK]
- 4 [↕]: Select the outside line. → [Edit]
- 5 [Menu] → [↕]: "Erase" → [OK]
- 6 [↕]: "Yes" → [OK] → [↵]

Baby monitor sensitivity

You can adjust the sensitivity of the baby monitor. Increase or decrease the sensitivity to adjust the sound level needed to trigger the baby monitor feature.

- This feature cannot be set during a monitoring call.
- 1 Press [Menu] on the handset being monitored.
 - 2 [↕]: "Sensitivity Level" → [OK]
 - 3 [↕]: Select the desired setting. → [OK] → [↵]

Answering the baby monitor

■ When monitoring with a handset:

Press [↵] to answer calls.

If you want to respond from the monitoring handset, press [↵].

- The monitoring handset will answer calls automatically when the auto intercom feature is set to "On" (page 16).

Note:

- If you receive an outside call when communicating with the monitored handset, you hear 2 tones. To answer the call, press [↵], then press [↵].

■ When monitoring from an outside line:

To answer a call, follow the operation for your phone.

If you want to respond from the monitoring handset, press [#][1] using tone dialling.

You can turn off the baby monitor feature by pressing [#][0].

Note:

- 2 minutes after the monitored handset starts a call, communication between the monitored handset and monitoring phone line is turned off automatically.

Other programming

Changing the handset name

Each handset can be given a customised name ("Bob", "Kitchen", etc.). This is useful when you make intercom calls between handsets. You can also select whether or not the handset name is displayed in standby mode. The default setting is "No". If you select "Yes" without entering any handset name, "Handset 1" to "Handset 6" is displayed.

- 1 **[Menu]** (right soft key) **#104**
- 2 Enter the desired name (max. 10 characters).
- 3 **[OK]**
- 4 **[↕]**: Select the desired setting. → **[OK]**
2 times → **[↵]**

Storing an area code to be deleted automatically

In some situations, phone numbers stored automatically in the caller list (page 36) will include area codes. If you do not want to dial the area code when making calls from the caller list, you can store the area code which you want the unit to delete automatically.

Example: You have stored the area code "09". If you make a call from the caller list to the phone number "09-456-7890", the unit dials "456-7890".

- 1 **[Menu]** (right soft key) **#255**
- 2 Enter an area code (5 digits max.). → **[OK]** → **[↵]**

Note for New Zealand:

- The use of this feature can prevent a National Call from being dialled. E.g., in the case of the South Island, the "03" will be omitted and will therefore prevent a National Call to other areas of the South Island.

Call restriction

You can restrict selected handsets from dialling certain numbers. You can assign up to

6 phone numbers to be restricted, and select which handsets are to be restricted. Storing area codes here prevents the restricted handsets from dialling any phone number in that area code.

- 1 **[Menu]** (right soft key) **#256**
- 2 Enter the base unit PIN (default: "0000").
 - If you forget your PIN, contact an authorised service centre.
- 3 Select the handsets to be restricted by pressing **1** to **6**.
 - All handsets registered to the base unit are displayed.
 - "✓" is displayed next to the selected handset numbers.
 - To cancel a selected handset, press the same dial key again. "✓" disappears.
- 4 **[OK]**
- 5 Select a memory location by pressing **1** to **6**. → **[OK]**
- 6 Enter the phone number or area code to be restricted (8 digits max.). → **[OK]** → **[↵]**

Changing the base unit PIN

Important:

- If you change the PIN (Personal Identification Number), please make note of your new PIN. The unit will not reveal the PIN to you. If you forget your PIN, contact an authorised service centre.

- 1 **[Menu]** (right soft key) **#132**
- 2 Enter the current 4-digit base unit PIN (default: "0000").
- 3 Enter the new 4-digit base unit PIN. → **[OK]**
- 4 **[↕]**: "Yes" → **[OK]** → **[↵]**

Changing the unit's region setting/Resetting the base unit

- 1 **[Menu]** (right soft key) **#136**
- 2 **[↕]**: Select the desired country. → **[OK]**
"Australia" = Australia

Programming

“NewZealand” = New Zealand

3 [↕]: “Yes” → [OK] → [⏻]

Note:

- Changing the unit's region setting may cause the settings for your country or your customised settings to return to their default settings.

Calendar/Schedule

You can program 20 schedule alarms for each handset using the calendar. A schedule alarm sounds at the set time for 1 minute. A text memo can also be displayed for the schedule alarm.

Important:

- Make sure the unit's date and time setting is correct (page 12).

Adding a new entry

1 [Menu] (right soft key) →  → [OK]

2 [↕]: Select the desired date. → [OK]

3 [Menu] → [↕]: “New Entry” → [OK]

4 Edit the date if necessary. → [OK]

5 Set the desired time. → [OK]

6 Enter a text memo (30 characters max.; page 44). → [OK]

7 [↕]: Select the desired alarm tone. → [OK] 2 times

- You can select “Off” if you prefer not to hear an alarm tone.
- We recommend selecting a different ringer tone from the one used for outside calls.

8 [⏻]

Note:

- To stop the alarm, press [Stop] or place the handset on the base unit or charger.
- When the handset is in use, the alarm will not sound until the handset is in standby mode.

Viewing entries

1 [Menu] (right soft key) →  → [OK]

2 To see the entries on the selected date, press [OK].

To see the schedule list, press [List].

- You can see detailed information about the schedule by pressing [Menu]. → [↕]: “Detail” → [OK]

Editing an entry

1 [Menu] (right soft key) →  → [OK]

2 [List] → [↕]: Select the desired entry.

3 [Menu] → [↕]: “Edit” → [OK]

4 Edit the date if necessary. → [OK]

5 Edit the time if necessary. → [OK]

6 Edit the text memo if necessary (30 characters max.). → [OK]

7 [↕]: Select the desired alarm tone. → [OK] 2 times → [⏻]

Erasing an entry

Schedule alarm entries are not erased automatically after the schedule alarm sounds. Erase unwanted entries.

1 [Menu] (right soft key) →  → [OK]

2 [List] → [↕]: Select the desired entry.

3 [Menu] → [↕]: “Erase” → [OK]

4 [↕]: “Yes” → [OK] → [⏻]

Erasing all entries

1 [Menu] (right soft key) →  → [OK]

2 [List] → [Menu]

3 [↕]: “Erase All” → [OK]

4 [↕]: “Yes” → [OK]

5 [↕]: “Yes” → [OK] → [⏻]

Registering a unit

Operating additional units

Additional handsets

Up to 6 handsets can be registered to a single base unit.

Important:

- The additional handset model recommended for use with this unit is noted on page 4. If another handset model is used, certain operations may not be available.

Additional base units

Handsets can be registered to up to 4 base units, allowing you to add additional base units and extend the area in which your handset(s) can be used. If a handset moves out of range of its base unit when "Auto" is selected on base unit (page 33), it looks for another base unit to make or receive calls. A base unit and the handsets it communicates with is called a "radio cell".

Note:

- Calls are disconnected when the handset moves from one radio cell to another.

Registering a handset to a base unit

The supplied handset and base unit are pre-registered. If for some reason the handset is not registered to the base unit (for example,  is displayed even when the handset is near the base unit), re-register the handset.

- Handset:**
[Menu] (right soft key) **#130**
- [↕]**: Select a base unit number. → **[OK]**
 - This number is used by the handset as a reference only.
- Base unit:**
 Press and hold **[⏻]** for about 5 seconds.
 - If all registered handsets start ringing, press **[⏻]** again to stop, then repeat this step.

4 Handset:

[OK] → Wait until "Base PIN" is displayed. → Enter the base unit PIN (default: "0000"). → **[OK]**

- If you forget your PIN, contact an authorised service centre.

Selecting a base unit

When "Auto" is selected, the handset automatically uses any available base unit it is registered to. When a specific base unit is selected, the handset makes and receives calls using that base unit only. If the handset is out of range of that base unit, no calls can be made.

- [Menu]** (right soft key) **#137**
- [↕]**: Select the desired base unit number, or "Auto". → **[OK]**

Deregistering a handset

A handset can cancel its own registration to the base unit, or other handsets registered to the same base unit. This allows the handset to end its wireless connection with the system.

- [Menu]** (right soft key) **#131**
 - All handsets registered to the base unit are displayed.
- [↕]**: Select the handset you want to cancel. → **[OK]**
- [↕]**: "Yes" → **[OK]**
- [⏻]**

Cancelling a base unit

A handset can cancel a base unit that it is registered to. This allows the base unit to end its wireless connection with the system.

- [Menu]** (right soft key) **#130**
- [↕]**: Select the base unit you want to cancel. → **[OK]**
- [↕]**: "Yes" → **[OK]** → **[⏻]**

Programming

Increasing the range of the base unit

You can increase the signal range of the base unit by using a DECT repeater. Please use only the Panasonic DECT repeater noted on page 3. Contact your Panasonic dealer for details.

Important:

- Before registering the DECT repeater to this base unit, you must turn the DECT repeater mode on.
- Do not use more than one DECT repeater at a time.

Setting the DECT repeater mode

- 1 **[Menu]** (right soft key) **[#138]**
- 2 **[↓]**: Select the desired setting. → **[OK]**
→ **[↻]**

Registering the DECT repeater (KX-A405AL) to the base unit

Note:

- Please use a DECT repeater that has not yet been registered to another unit. If the DECT repeater is registered to another unit, deregister it first, referring to the Installation Guide for the DECT repeater.

- 1 **Base unit:**
Press and hold **[••]** for about 5 seconds.
- 2 **DECT repeater:**
Connect the AC adaptor, then wait until the **(i)** indicator and **Y** indicator light green.
- 3 **Base unit:**
To exit the registration mode, press **[••]**.

Using Caller ID service

Important:

- This unit is Caller ID compatible. To use Caller ID features (such as displaying caller phone numbers), you must subscribe to a Caller ID service. Contact your service provider/telephone company for details.

For New Zealand

- For all local and national incoming calls, your display will show the area code (e.g. 09 for Auckland) or the cellular prefix (e.g. 0274 for Telecom Cellular) followed by the caller's telephone number. An Auckland caller's number will be displayed as 09XXXXXXX. The seven X's represent the seven digits of the caller's telephone number. A caller from a 6-digit Telecom Cellular number will be displayed as 0274XXXXXX. For incoming international calls, your display may only show "0000". For business users on a Centrex line, your display will show Centrex extension numbers in the shorter extension number format used within your company.
- The Caller ID information will not be presented on incoming fax calls if Telecom FaxAbility is used.

Using toll services from Telecom or another company (for New Zealand)

Your telephone company may charge you for a local call if the number dialled has the area code prefix included. If this is unacceptable, dial only the 7-digit local number. Do not dial the "0" prefix or the area code.

Caller ID features



When an outside call is being received, the caller information is displayed.

Caller information for the last 50 callers is logged in the caller list from the most recent call to the oldest.



- If the unit cannot receive caller information, the following is displayed:
 - **"Out of Area"**: The caller dials from an area which does not provide a Caller ID service.

- **"Private Caller"**: The caller requests not to send caller information.
- If the unit is connected to a PBX system, caller information may not be properly received. Contact your PBX supplier.

Missed calls

If a call is not answered, the unit treats it as a missed call and  is displayed. This lets you know if you should view the caller list to see who called while you were away. Even if only one missed call in the caller list is viewed (page 36),  disappears from the display. When you receive another new call,  is displayed again.

Note:

- Even when there are unviewed missed calls,  disappears from the standby display if the following operation is performed by one of the registered handsets:
 - Being replaced on the base unit or charger.
 - Pressing [].

Phonebook name display

When caller information is received and it matches a phone number stored in the phonebook, the stored name in the phonebook is displayed and logged in the caller list.

Call waiting and Caller ID compatible (for Australia)

If you subscribe to Caller ID service, your handset displays the 2nd caller's information while talking. After you hear a call waiting tone, the caller's phone number will be displayed.

You can answer the 2nd call, keeping the 1st call on hold. Follow your service provider/telephone company instructions using **[R/ECO]**. (Recall/flash function)

- If the phone number is stored in the phonebook with its name, the caller's name will also be displayed.

Caller ID Service

- Please contact your service provider/ telephone company for details and availability in your area.

For Caller ID Type II users

When you receive a 2nd call during a conversation, you will hear a signal tone following the call waiting tone and the **conversation will be interrupted or muted for a short period of time**. This is not a fault of the product as these events are normal.

- The tones are generated by your service provider/telephone company.

For Call Waiting or Call Waiting Caller ID service users (for New Zealand)

To use call waiting or Call Waiting Caller ID, you must first subscribe with your service provider/telephone company.

This feature allows you to receive calls while you are already talking on the phone. If you receive a call while on the phone, you will hear a call waiting tone.

If you subscribe to both Caller ID and Call Waiting with Caller ID services, the 2nd caller's information is displayed after you hear the call waiting tone on the handset.

- 1 Press **[R/ECO]** to answer the 2nd call.
- 2 To switch between calls, press **[R/ECO]**.

Note:

- Please contact your service provider/ telephone company for details and availability of this service in your area.

Caller list

Important:

- Make sure the unit's date and time setting is correct (page 12).

Viewing the caller list and calling back

- 1 **[→]**

- 2 Press **[▼]** to search from the most recent call, or press **[▲]** to search from the oldest call.
 - You can see the detailed information about the caller by pressing **[Detail]** when in multiple display mode.
- 3 To call back, press **[↶]**.
To exit, press **[↶⏻]**.

Note:

- If the entry has already been viewed or answered, "✓" is displayed.
- If you do not want to dial the area code when making calls from the caller list, you can store the area code which you want the unit to delete automatically (page 31).

Editing a caller's phone number

The caller's telephone number, which is sent to your telephone from your local telephone exchange, includes "0" and an area code prefix. For local calls, "0" and the area code prefix can be omitted. (for New Zealand)

- 1 **[→]**
- 2 **[↕]**: Select the desired entry. → **[Detail]**
- 3 **[Menu]** → **[↕]**: "Edit" → **[OK]**
- 4 Edit the number.
- 5 **[↶]**

Erasing selected caller information

- 1 **[→]**
- 2 **[↕]**: Select the desired entry.
- 3 **[Erase]** → **[↕]**: "Yes" → **[OK]** → **[↶⏻]**

Erasing all caller information

- 1 **[→]**
- 2 **[Erase]** → **[↕]**: "Yes" → **[OK]** → **[↶⏻]**

Answering system

The answering system can answer and record calls for you when you are unavailable to answer the phone. You can also record phone conversations (page 15).

You can also set the unit to play a greeting message but not to record caller messages by selecting “**Greeting Only**” as the recording time setting (page 42).

Important:

- Make sure the unit’s date and time setting is correct (page 12).
- The unit’s answering system will not answer incoming calls on your FaxAbility number. (for New Zealand)

Memory capacity (including your greeting message)

The total recording capacity is about 40 minutes. A maximum of 64 messages can be recorded.

Note:

- When message memory becomes full:
 - “**Messages Full**” is shown on the handset display.
 - If you use the pre-recorded greeting message, the unit automatically switches to another pre-recorded greeting message asking callers to call again later.
 - If you recorded your own greeting message, the same message is still announced to callers even though their messages are not recorded.

Turning the answering system on/off

The answering system is preset to on.

- 1 **To turn on:**
[Menu] (right soft key) **#327**
To turn off:
[Menu] (right soft key) **#328**
- 2 **[**]

Note:

- When the answering system is turned on,  is displayed next to the battery icon.



Greeting message

When the unit answers a call, a greeting message is played to callers.

You can use either:

- your own greeting message
- a pre-recorded greeting message

Recording your greeting message

- 1 **[Menu]** (right soft key) **#302**
- 2 **[]: “Yes” → [OK]**
- 3 After a beep sounds, hold the handset about 20 cm away and speak clearly into the microphone (2 minutes and 30 seconds max.).
- 4 Press **[Stop]** to stop recording. → **[**]

Using a pre-recorded greeting message

The unit provides 2 pre-recorded greeting messages:

- If you erase or do not record your own greeting message, the unit plays a pre-recorded greeting asking callers to leave a message.
- If the message recording time (page 42) is set to “**Greeting Only**”, callers’ messages are not recorded and the unit plays a different pre-recorded greeting message asking callers to call again.

Resetting to a pre-recorded greeting message

If you want to use a pre-recorded greeting message once you record your own greeting message, you need to erase your own greeting message.

- 1 **[Menu]** (right soft key) **#304**

Answering System

2 [OK] → [🔌]

Playing back the greeting message

1 [Menu] (right soft key) [#] 3 0 3

2 [🔌]

Listening to messages

When new messages have been recorded, **00** is displayed on the handset with the total number of new messages.

- 1 **To listen to new messages:**
[Menu] (right soft key) [#] 3 2 3
To listen to all messages:
[Menu] (right soft key) [#] 3 2 4
- 2 When finished, press [🔌].

Note:

- To switch to the receiver, press [📶].

Listening to messages from the message list

You can select the item to play back.

- 1 [Menu] (right soft key) [#] 3 2 9
- 2 [↕]: Select the desired item from the message list. → [Play]
 - You can erase the selected message as follows:
[Menu] → [↕]: "Erase" → [OK]
→ [↕]: "Yes" → [OK]
- 3 When finished, press [🔌].

Note:

- If the item has already been heard, "✓" is displayed, even if it was heard using another handset.
- "Message" is displayed in the message list for any recorded conversations or if the unit cannot receive caller information.

Operating the answering system

[Menu] (right soft key) → 00 → [OK]

Key	Operation
[▲] or [▼]	Adjust the receiver or speaker volume (during playback)
1 or [◀]	Repeat message (during playback)*1
2 or [▶]	Skip message (during playback)*2
3	Enter the "Settings" menu
4	Play new messages
5	Play all messages
6	Play greeting message
7 6	Record greeting message
8	Turn answering system on
[Menu]	Pause message*3
9 or [Stop]	Stop recording Stop playback
0	Turn answering system off
* 4	Erase currently playing message
* 5	Erase all messages
* 6	Reset to a pre-recorded greeting message

*1 If pressed within the first 5 seconds of a message, the previous message is played except when playing back from the message list.

*2 When you play a message from the message list, the unit stops message playback and the display goes back to the message list.

*3 To resume playback:
[↕]: "Play" → [OK]

*4 You can also erase as follows:
[Menu] → [↕]: "Erase" → [OK] → [↕]: "Yes" → [OK]

Rewinding the message

Press and hold [◀] until the unit plays the desired part of the message.

- During rewinding, the handset makes a continuous beeping sound. Rewinding speed may vary depending on the recorded message.

Answering System

- At the beginning of the message, the unit plays the message at normal speed.

Fast-forwarding the message

Press and hold **[▶]** until the unit plays the desired part of the message.

- During fast-forwarding, the handset makes a continuous beeping sound.
Fast-forwarding speed may vary depending on the recorded message.
- Even if you press and hold **[▶]** when the end of this message is played, the next message is played at normal speed.

Calling back (Caller ID subscribers only)

- 1 Press **[Menu]** during playback.
- 2 **[↕]**: "Call Back" → **[OK]**

Editing the number before calling back

- 1 Press **[Menu]** during playback.
- 2 **[↕]**: "Edit & Call" → **[OK]**
- 3 Edit the number. → **[↶]**

Erasing all messages

- 1 **[Menu]** (right soft key) **#325**
- 2 **[↕]**: "Yes" → **[OK]** → **[↶]**

Advanced new message alerting features

Audible message alert

This feature allows the handset to beep to inform you of a new message arrival when new messages are recorded. The handset beeps 2 times every minute until you listen to the messages, if the "Handset Beep" setting is turned on. The default setting is "Off".

- 1 **[Menu]** (right soft key) **#339**

- 2 **[↕]**: Select the desired setting. → **[OK]**
→ **[↶]**

New message alert by a call

This feature allows you to receive a notification by phone when new messages are recorded. The base unit calls a phone number you specify. You can then operate the answering system remotely to listen to the new message.

To use this feature, you must:

- store a phone number to which the unit makes the call to.
 - turn on the new message alert setting.
- After you answer the new message alert call, you can listen to messages from that call (page 40).

Important:

- A new message alert is stopped 1 minute after the unit starts to call. The unit will not retry the call even if the call is not answered.

Storing a phone number to which the unit makes an alert call

■ From the phonebook:

- 1 **[Menu]** (right soft key) **#338**
- 2 **[↕]**: "Notification to" → **[OK]**
→ **[Add]**
- 3 **[↕]**: "Phonebook" → **[OK]**
- 4 **[↕]**: Select the desired phonebook entry. → **[OK]**
- 5 **[↕]**: Select the desired phone number.
→ **[OK]** → **[↶]**

■ By entering a phone number:

- 1 **[Menu]** (right soft key) **#338**
- 2 **[↕]**: "Notification to" → **[OK]**
→ **[Add]**
- 3 **[↕]**: "Manual" → **[OK]**
- 4 Enter the desired name (16 characters max.). → **[OK]**
- 5 Enter the desired number (24 digits max.). → **[OK]** 2 times → **[↶]**

Answering System

Turning on/off the new message alert setting

- 1 **[Menu]** (right soft key) **[#][3][3][8]**
- 2 **[↕]**: "On/Off" → **[OK]**
- 3 **[↕]**: Select the desired setting. → **[OK]**
→ **[↵]**

Editing the set phone number

- 1 **[Menu]** (right soft key) **[#][3][3][8]**
- 2 **[↕]**: "Notification to" → **[OK]**
- 3 **[Menu]** → **[↕]**: "Edit" → **[OK]**
- 4 Edit the name if necessary (16 characters max.). → **[OK]**
- 5 Edit the phone number if necessary (24 digits max.). → **[OK]** 2 times → **[↵]**

Erasing the set phone number

- 1 **[Menu]** (right soft key) **[#][3][3][8]**
- 2 **[↕]**: "Notification to" → **[OK]**
- 3 **[Menu]** → **[↕]**: "Erase" → **[OK]**
- 4 **[↕]**: "Yes" → **[OK]** → **[↵]**
 - The new message alert setting is turned off.

Activating/inactivating the remote access code to play messages

If you activate this feature, you must enter the remote access code (page 40) to play the new message from the new message alert call. This is so that unauthorised parties cannot listen to your messages. The default setting is "Inactivate".

- "Inactivate": You can listen to the message by pressing **[4]** to play new messages (without entering the remote access code).
- "Activate": You must enter your remote access code (page 40) and then press **[4]** to play new message.

- 1 **[Menu]** (right soft key) **[#][3][3][8]**
- 2 **[↕]**: "Remote Code" → **[OK]**

- 3 **[↕]**: "Activate" or "Inactivate" → **[OK]** → **[↵]**

Listening to messages

After you answer the new message alert, you can listen to the messages as follows.

■ When the remote access code is set to "Inactivate":

Press **[4]** to play the new message during the announcement.

■ When the remote access code is set to "Activate":

- 1 Enter the remote access code (page 40) during the announcement.

- 2 Press **[4]** to play the new message.

Note:

- Within 10 seconds after listening to new messages, you can press **[#][9]** during the call to turn off the new message alert by a call feature.
- Even if the unit makes a new message alert call, the handset redial list does not show the record.

Remote operation

Using a touch-tone phone, you can call your phone number from outside and access the unit to listen to messages or change answering system settings. The unit's voice guidance prompts you to press certain dial keys to perform different operations.

Remote access code

A 3-digit remote access code must be entered when operating the answering system remotely. This code prevents unauthorised parties from listening to your messages remotely.

Important:

- In order to operate the answering system remotely, you must first set a remote access code.

- 1 **[Menu]** (right soft key) **[#][3][0][6]**

Answering System

- To turn on remote operation, enter the desired 3-digit remote access code.

- [OK] → [↶]**

Deactivating remote operation

Press **[*]** in step 2 on "Remote access code", page 40.

- The entered remote access code is deleted.

Using the answering system remotely

- Dial your phone number from a touch-tone phone.
- After the greeting message starts, enter your remote access code.
- Follow the voice guidance prompts as necessary or control the unit using remote commands (page 41).
- When finished, hang up.

Voice guidance

During remote operation, the unit's voice guidance starts and prompts you to press **[1]** to perform a specific operation, or press **[2]** to listen to more available operations.

Note:

- If you do not press any dial keys within 10 seconds after a voice guidance prompt, the unit disconnects your call.

Remote commands

You can press dial keys to access certain answering system functions without waiting for the voice guidance to prompt you.

Key	Operation
[1]	Repeat message (during playback)*1
[2]	Skip message (during playback)
[4]	Play new messages
[5]	Play all messages

Key	Operation
[6]	Play greeting message
[7]	Record greeting message
[9]	Stop recording Stop playback
[0]	Turn answering system off
[*]4	Erase currently playing message
[*]5	Erase all messages
[*]6	Reset to a pre-recorded greeting message (during greeting message playback)
[*]#	End remote operation (or hang up)

*1 If pressed within the first 5 seconds of a message, the previous message is played.

Turning on the answering system remotely

- Dial your phone number from a touch-tone phone.
- Let the phone ring 15 times.
 - A long beep is heard.
- Enter your remote access code within 10 seconds after the long beep.
 - The greeting message is played back.
 - You can either hang up, or enter your remote access code again and begin remote operation (page 40).

Answering system settings

Call screening

While a caller is leaving a message, you can listen to the call through the handset's speaker. To adjust the speaker volume, press **[▲]** or **[▼]** repeatedly. You can answer the call by pressing **[↶]** on the handset. Call screening can be set for each handset. The default setting is "On".

- [Menu]** (right soft key) **#310**

Answering System

- 2 [↕]: Select the desired setting. → [OK]
→ [🔌]

Number of rings before the unit answers a call

You can change the number of times the phone rings “**Number of Rings**” before the unit answers a call. You can select 2 to 9 rings, or “**Auto**”.

The default setting is “**5 Rings**”.

“**Auto**”: The unit’s answering system answers at the end of the 2nd ring when new messages have been recorded, or at the end of the 5th ring when there are no new messages. If you call your phone from outside to listen to new messages (page 41), you know that there are no new messages when the phone rings for the 3rd time. You can then hang up without being charged for the call.

- 1 [Menu] (right soft key) [#][2][1][1]
- 2 [↕]: Select the desired setting. → [OK]
→ [🔌]

For service provider voice mail subscribers (for Australia)

To receive voice mail and use the answering system properly, please note the following:

- “Voice mail” is a service provided by your service provider/telephone company (page 44). You will need to first subscribe or activate this service through your service provider/telephone company. Contact your service provider/telephone company on how to operate this service and how you will be notified that you have messages on your voice mail.

To use this service, you will be required to leave your answering machine off on your unit.

This will allow the voice mail to receive any messages.

- To use the unit’s answering machine rather than the voice mail service provided by your service provider/telephone company, please contact your service provider/telephone company to have it removed or deactivated permanently or temporarily.

Alternatively you can leave this service connected and change the “**Number of Rings**” to a shorter duration on your unit so your unit’s answering machine can pick up the call prior to the voice mail provided by your service provider/telephone company.

For Telecom Call Minder or TelstraClear Message Mailbox service subscribers (for New Zealand)

To receive Call Minder or Message Mailbox messages and use the unit’s answering system properly, please note the following:

- “Call Minder” and “Message Mailbox” are services provided by your service provider/telephone company (page 44). You will need to first subscribe or activate this service through your service provider/telephone company. Contact your service provider/telephone company on how to operate this service and how you will be notified that you have messages. To use this service you will be required to leave your answering machine off on your unit (page 37). This will allow the service to receive any messages.
- To use the unit’s answering machine rather than the service provided by your service provider/telephone company, please contact your service provider/telephone company to have it removed or deactivated permanently or temporarily. Alternatively you can leave this service connected and change the “**Number of Rings**” to a shorter duration on your unit so your unit’s answering machine can pick up the call prior to the service provided by your service provider/telephone company.

Caller’s recording time

You can change the maximum message recording time allowed for each caller. The default setting is “**3 Minutes**”.

- 1 [Menu] (right soft key) [#][3][0][5]
- 2 [↕]: Select the desired setting. → [OK]
→ [🔌]

Selecting “Greeting Only”

You can select “**Greeting Only**” which sets the unit to announce a greeting message to callers but not record messages.

Select “**Greeting Only**” in step 2 on “Caller’s recording time”, page 42.

Note:

- When you select “**Greeting Only**”:
 - If you do not record your own message, the unit will play the pre-recorded greeting-only message asking callers to call again later.
 - If you use your own message, record the greeting-only message asking callers to call again later (page 37).

Useful Information

Voice mail service

For Australia

Voice mail is an automatic answering service offered by your service provider/telephone company.

For New Zealand

To receive Call Minder or Message Mailbox messages, please note the following:



“Call Minder” and “Message Mailbox” are automatic answering services offered by your service provider/telephone company.

For Australia and New Zealand

After you subscribe to this service, your service provider/telephone company's voice mail system answers calls for you when you are unavailable to answer the phone or when your line is busy. Messages are recorded by your service provider/telephone company, not your telephone.







When you have new messages,  is displayed on the handset if message indication service is available. Please contact your service provider/telephone company for details of this service.

Important:

- If  still remains on the display even after you have listened to new messages, turn it off by pressing and holding  for 2 seconds.
- To use the voice mail service provided by your service provider/telephone company rather than the unit's answering system, turn off the answering system (page 37). For details, see page 42.

Character entry



The dial keys are used to enter characters and numbers. Each dial key has multiple characters assigned to it. The characters that can be entered depend on the character entry mode (page 44).

- Press  or  to move the cursor left or right.
- Press dial keys to enter characters and numbers.
- Press  to erase the character or number highlighted by the cursor. Press and hold  to erase all characters or numbers.
- Press  (A→a) to switch between uppercase and lowercase.
- To enter another character located on the same dial key, press  to move the cursor to the next space, then press the appropriate dial key.
- If you do not press any dial key within 5 seconds after entering a character, the character is fixed and the cursor moves to the next space.

Character entry modes

The available character entry modes are Alphabet (ABC), Numeric (0-9), Greek (ΑΒΓ), Extended 1 (ĂÄÅ), Extended 2 (ŠŠŠ), and Cyrillic (АБВ). When in these entry modes except Numeric, you can select which character is entered by pressing a dial key repeatedly.

When the unit displays the character entry screen:

 → : Select a character entry mode. → 

Note:

-  in the following tables represents a single space.

Useful Information

Alphabet character table (ABC)

0	1	2	3	4	5	6	7	8	9	#
_ 0	& ' () * , - . / 1	A B C	D E F	G H I	J K L	M N O	P Q R	T U V	W X Y	#
		2	3	4	5	6	S 7	8	Z 9	
		a b c	d e f	g h i	j k l	m n o	p q r s	t u v	w x y	
		2	3	4	5	6	7	8	z 9	

Numeric entry table (0-9)

0	1	2	3	4	5	6	7	8	9	#
0	1	2	3	4	5	6	7	8	9	#

Greek character table (ΑΒΓ)

0	1	2	3	4	5	6	7	8	9	#
_ 0	& ' () * , - . / 1	A B Γ	Δ E Z	H Θ I	K Λ M	N O	Π P Σ	T Υ Φ	Χ Ψ Ω	#
		2	3	4	5	6	7	8	9	

Extended 1 character table (AĂÄ)

0	1	2	3	4	5	6	7	8	9	#
_ 0	& ' () * , - . / 1	A À Á	D È È	G Ğ H	J K L	M N Ñ	P Q R	T U Ù	W X Y	#
		Â Ã Ä	É Ê Ë	Ì Í Î	5	O Ò Ó	S Ş ß	Ú Û Ü	Ý Þ Z	
		À Æ B	Ë F 3	Ì Í Î		Ô Ö Ø	7	Û V 8	9	
		C Ç 2		4		ø 6				
		a à á	d e è	g ğ h	j k l 5	m n ñ	p q r s	t u ù	w X x	
		â ã ä	é ê ë	ì í î		o ò ó	ş ß 7	ú û ü	y ý z	
		á æ b	ë f 3	ï ï ï		ô ö ø		ü v 8	9	
		c ç 2		4		ø 6				

- The following are used for both uppercase and lowercase: ø Ŵ Ŷ

Extended 2 character table (ŠŠš)

0	1	2	3	4	5	6	7	8	9	#
_ 0	& ' () * , - . / 1	A Á Ä	D Ď È	G H I	J K L	M N Ń	P Q R	T Ť U	W X Y	#
		Š Š Š	É Ě Ě	Í 4	Ł Ł Ł	Ń Ń Ó	Ř Ŕ S	Ú Ů Ú	Ý Ź Z	
		Č Č 2	F 3		5	Ō Ő 6	Š Š 7	ú v 8	Ž Ž Ž	
		a á ä	d ď e	g h i	j k l 5	m n Ń	p q r	t ť u	w x y	
		Š š š	é ě ě	4	Ł ł 5	ň ó ó	Ř ř s	ú ů Ů	ý Ź z	
		Č č 2	f 3			ő ő 6	Š š 7	ú v 8	Ž ž Ž	
								9		

Useful Information

- The following are used for both uppercase and lowercase:

À Ć Ć Ę Ł Ł Ł Ń Ŕ Ś Š ů ý Ž Ž Ž

Cyrillic character table (АБВ)

0	1	2	3	4	5	6	7	8	9	#
Л О Г Є І І ÿ	& ' () * , - . / 1	А Б В Г 2	Д Е Ж З 3	И Й К Л 4	М Н О П 5	Р С Т У 6	Ф Х Ц Ч 7	Ш Щ Ъ Ы 8	Ь Э Ю Я 9	#



Error messages

Display message	Cause/solution
Base no power or No link to base. Reconnect main base AC adaptor.	<ul style="list-style-type: none"> The handset has lost communication with the base unit. Move closer to the base unit and try again. Unplug the base unit's AC adaptor to reset the unit. Reconnect the adaptor and try again. The handset's registration may have been cancelled. Re-register the handset (page 33).
Check Phone Line	<ul style="list-style-type: none"> The supplied telephone line cord has not been connected yet or not connected properly. Check the connections (page 9).
Error	<ul style="list-style-type: none"> Recording was too short. Try again.
Memory Full	<ul style="list-style-type: none"> The phonebook memory is full. Erase unwanted entries (page 19). Message memory is full. Erase unwanted messages (page 38). The call barred list memory is full. Erase unwanted entries (page 29). The schedule alarm memory is full. Erase unwanted entries (page 32). The maximum number of base units (4) is already registered to the handset. Cancel unused base unit registrations from the handset (page 33).
Use rechargeable battery.	<ul style="list-style-type: none"> A wrong type of battery such as Alkaline or Manganese was inserted. Use only the rechargeable Ni-MH batteries noted on page 3, 6.
You must first subscribe to Caller ID.	<ul style="list-style-type: none"> You must subscribe to a Caller ID service. Once you receive caller information after subscribing to a Caller ID service, this message will not be displayed.

Troubleshooting

If you still have difficulties after following the instructions in this section, disconnect the base unit's AC adaptor and turn off the handset, then reconnect the base unit's AC adaptor and turn on the handset.

General use



Problem	Cause/solution
The handset does not turn on even after installing charged batteries.	<ul style="list-style-type: none"> Place the handset on the base unit or charger to turn on the handset.
The unit does not work.	<ul style="list-style-type: none"> Make sure the batteries are installed correctly (page 9). Fully charge the batteries (page 9). Check the connections (page 9). Unplug the base unit's AC adaptor to reset the unit and turn off the handset. Reconnect the adaptor, turn on the handset and try again. The handset has not been registered to the base unit. Register the handset (page 33).
The handset display is blank or dark.	<ul style="list-style-type: none"> The handset is in screen saver mode (page 12). Activate the handset display again by: <ul style="list-style-type: none"> pressing [] when on a call. pressing [] at all other times. "LCD in charging" is set to "OFF" while on charge. Change the setting (page 24). The handset is not turned on. Turn the power on (page 12).
I cannot hear a dial tone.	<ul style="list-style-type: none"> Make sure that you are using the supplied telephone line cord. Your old telephone line cord may have a different wiring configuration. The base unit's AC adaptor or telephone line cord is not connected. Check the connections. Disconnect the base unit from the telephone line and connect the line to a known working telephone. If the working telephone operates properly, contact our service personnel to have the unit repaired. If the working telephone does not operate properly, contact your service provider/telephone company.
The handset beeps.	<ul style="list-style-type: none"> New messages have been recorded. Listen to the new messages (page 38).
The handset display begins operating automatically.	<ul style="list-style-type: none"> Demonstration mode is activated. Please connect the telephone line cord to the telephone line socket (page 9).

Useful Information

Menu list

Problem	Cause/solution
The display is in a language I cannot read.	<ul style="list-style-type: none">● Change the display language (page 12).
I cannot activate the eco mode.	<ul style="list-style-type: none">● You cannot set eco mode when you set the DECT repeater mode "On". If required, set the DECT repeater mode to "off" (page 34).
I cannot display the wallpaper.	<ul style="list-style-type: none">● Wallpaper is displayed in the standby mode only when you select "Digital (Small)" or "Off" for the clock setting. Change the clock setting (page 24).
I cannot register a handset to a base unit.	<ul style="list-style-type: none">● The maximum number of base units (4) is already registered to the handset. Cancel unused base unit registrations from the handset (page 33).● The maximum number of handsets (6) is already registered to the base unit. Cancel unused handset registrations from the base unit (page 33).● You entered the wrong PIN. If you forget your PIN, contact an authorised service centre.

Battery recharge

Problem	Cause/solution
The handset beeps and/or  flashes.	<ul style="list-style-type: none">● Battery charge is low. Fully charge the batteries (page 9).
I fully charged the batteries, but <ul style="list-style-type: none">–  still flashes or– the operating time seems to be shorter.	<ul style="list-style-type: none">● Clean the battery ends (\oplus, \ominus) and the charge contacts with a dry cloth and charge again.● It is time to replace the batteries (page 9).

Making/answering calls, intercom

Problem	Cause/solution
 is displayed.	<ul style="list-style-type: none">● The handset is too far from the base unit. Move closer.● The base unit's AC adaptor is not properly connected. Reconnect AC adaptor to the base unit.● The handset is not registered to the base unit. Register it (page 33).● Activating one touch eco mode reduces the range of the base unit in standby mode. If required, turn eco mode off (page 13).

Useful Information

Problem	Cause/solution
Noise is heard, sound cuts in and out.	<ul style="list-style-type: none">● You are using the handset or base unit in an area with high electrical interference. Re-position the base unit and use the handset away from sources of interference.● Move closer to the base unit.● If you use a DSL/ADSL service, we recommend connecting a filter (contact your DSL/ADSL service provider) to the telephone line between the base unit and the telephone line socket. Contact your DSL/ADSL provider for details. (for Australia)● If you use a DSL/ADSL (JetStream) service, we recommend that you contact your DSL/ADSL service provider to have a DSL/ADSL Splitter installed. We do not recommend the use of generic DSL/ADSL filters. Contact your DSL/ADSL service provider for details. (for New Zealand)
Sound quality seems to be getting worse.	<ul style="list-style-type: none">● You have registered a handset that is not recommended (page 4). The clearest sound quality is only possible by registering the recommended handset.
The handset does not ring.	<ul style="list-style-type: none">● The ringer volume is turned off. Adjust ringer volume (page 14, 23).● Night mode is turned on. Turn it off (page 28).
I cannot make a call.	<ul style="list-style-type: none">● If you are using a BT double adaptor to connect the unit, remove the adaptor and connect the unit to the phone wall socket directly. If the unit operates properly, check or replace the adaptor. (for New Zealand)● You dialled a call restricted number (page 31).● The key lock feature is turned on. Turn it off (page 16).● The unit is not designed to be used with rotary/pulse dialling services.

Useful Information

Caller ID

Problem	Cause/solution
Caller information is not displayed.	<ul style="list-style-type: none">• You must subscribe to a Caller ID service. Contact your service provider/telephone company for details.• If your unit is connected to any additional telephone equipment, remove and plug the unit directly into the wall socket.• If you use a DSL/ADSL service, we recommend connecting a filter (contact your DSL/ADSL service provider) to the telephone line between the base unit and the telephone line socket. Contact your DSL/ADSL provider for details. (for Australia)• If you use a DSL/ADSL (JetStream) service, we recommend that you contact your DSL/ADSL service provider to have a DSL/ADSL Splitter installed. We do not recommend the use of generic DSL/ADSL filters. Contact your DSL/ADSL service provider for details. (for New Zealand)• Other telephone equipment may be interfering with this unit. Disconnect the other equipment and try again. (for Australia)• Other telephone equipment such as a monitored Burglar Alarm or the modem in the SKY Digital decoder may be interfering with this unit. Disconnect the other equipment and try again. (for New Zealand)
Caller information is slow to display.	<ul style="list-style-type: none">• Depending on your service provider/telephone company, the unit may display the caller's information at the 2nd ring or later. Set the first ring to "o££" (page 23).• Move closer to the base unit.
Time on the unit has shifted.	<ul style="list-style-type: none">• Incorrect time information from incoming Caller ID changes the time. Set the time adjustment to "Manual" (off) (page 23).

Answering system

Problem	Cause/solution
The unit does not record new messages.	<ul style="list-style-type: none">• The answering system is turned off. Turn it on (page 37).• The message memory is full. Erase unwanted messages (page 39).• The recording time is set to "Greeting Only". Change the setting (page 42).• If you subscribe to a voice mail service, messages are recorded by your service provider/telephone company, not your telephone. Change the unit's number of rings setting or contact your service provider/telephone company (page 42).
I cannot operate the answering system remotely.	<ul style="list-style-type: none">• The remote access code is not set. Set the remote access code (page 40).• You are entering the wrong remote access code. If you have forgotten your remote access code, enter the remote access code setting to check your current code (page 40).• The answering system is turned off. Turn it on (page 41).

Useful Information

Problem	Cause/solution
The unit does not emit the specified number of rings.	<ul style="list-style-type: none">● If the first ring is turned off, the number of rings decreases by 1 from the specified number of rings.

Liquid damage

Problem	Cause/solution
Liquid or other form of moisture has entered the handset/base unit.	<ul style="list-style-type: none">● Disconnect the AC adaptor and telephone line cord from the base unit. Remove the batteries from the handset and leave to dry for at least 3 days. After the handset/base unit are completely dry, reconnect the AC adaptor and telephone line cord. Insert the batteries and charge fully before use. If the unit does not work properly, contact an authorised service centre.

Caution:

- To avoid permanent damage, do not use a microwave oven to speed up the drying process.

Useful Information

Warranty (for New Zealand)

Panasonic New Zealand undertakes to:

Repair or at its option, replace without cost to the owner, either for material or labour, any part which is found to be defective within two years of the date of purchase.

THIS EXPRESS WARRANTY DOES NOT COVER:

- 1) Pick up and delivery.
- 2) Batteries.
- 3) Repairs when the product has not been used in accordance with the Operating Instructions Manual or has been modified.
- 4) Normal maintenance and cleaning as required in the product's Operating Instructions Manual.
- 5) Service calls to:
 - a Correct the set up of the product
 - b Instruct you how to use the product
 - c Replace fuses or correct your building's wiring
- 6) Damage to the product caused by accident, misuse or Act of God.
- 7) Repairs when the product has been dismantled, repaired, modified or serviced by other than a Panasonic Authorised Dealer authorised to service that type of product.

IF YOUR PANASONIC PRODUCT FAILS WITHIN THE WARRANTY PERIOD:

Take it to the Authorised Panasonic Dealer from whom you purchased the product who will repair it (or arrange to have it repaired) during their normal business hours. All enquiries regarding warranty or otherwise, please call – Customer Support Centre Tel. No.: (09) 272 0178

NOTE: THIS EXPRESS WARRANTY IS OFFERED AS AN EXTRA BENEFIT AND DOES NOT AFFECT YOUR LEGAL RIGHTS.

Index

- A** Additional base units: 33
Additional handsets: 33
Alarm: 27
Answering calls: 14
Answering system: 37
 Call screening: 41
 Erasing messages: 38, 39, 41
 Greeting message: 37
 Greeting only: 42
 Listening to messages: 38, 41
 Message list: 38
 New message alerting: 39
 Number of rings: 42
 Recording time: 42
 Remote access code: 40
 Remote operation: 40
 Turning on/off: 37
Area code: 31
Auto intercom: 16
Auto talk: 14, 25
- B** Baby monitor: 29
Base unit
 Cancelling: 33
 Resetting: 31
 Selecting: 33
Battery: 9, 10
- C** Calendar: 32
Call restriction: 31
Call share: 16
Call Waiting: 36
Call waiting and Caller ID compatible: 35
Call Waiting Caller ID: 36
Caller ID service: 35
Caller list: 36
Caller list edit: 36
Category: 18
Chain dial: 19
Character entry: 44
Conference calls: 16
Control type: 11
- D** Date and time: 12
DECT repeater: 34
Direct command code: 21
Display
 Clock: 24
 Colour: 24
 Contrast: 24
 Display mode: 24
 Language: 12
 LCD backlight: 24
 Wallpaper: 24
- E** Eco mode: 13
Equalizer: 15
Error messages: 46
- F** First ring: 23
- H** Handset
 Deregistration: 33
 Name: 31
 Registration: 33
Hold: 14
- I** Incoming call barring: 28
Intercom: 16
- K** Key finder: 24, 26
Key lock: 16
Keytones: 25
- M** Making calls: 14
Missed calls: 35
Mute: 15
- N** Night mode: 27
Noise reduction: 15
- P** Pause: 14
Phonebook: 18
PIN: 31
Power failure: 10
Power on/off: 12
Privacy mode: 25
- R** Recall/flash: 15
Recording telephone conversations: 15
Redialling: 14
Region setting: 31
Ringer tone: 23
- S** Schedule: 32
Speakerphone: 14
Speed dial: 19
- T** Time adjustment: 23
Transferring calls: 16
Troubleshooting: 47
- V** Voice mail: 44
Volume
 Receiver: 14
 Ringer (Handset): 14, 23
 Speaker: 14

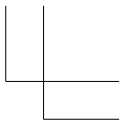
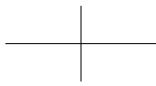
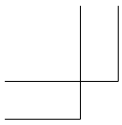

Notes

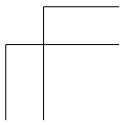
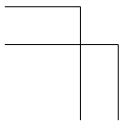
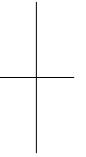
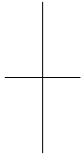

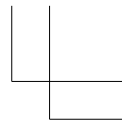
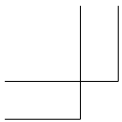

Notes

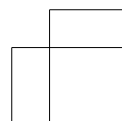
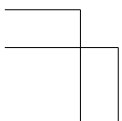
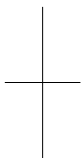

For your future reference

We recommend keeping a record of the following information to assist with any repair under warranty.

Serial No.	Date of purchase
(found on the bottom of the base unit)	
Name and address of dealer	

Attach your purchase receipt here.

For Australia Customer Care Centre Tel. No.: 132600 or website www.panasonic.com.au For New Zealand Customer Care Centre Tel. No.: (09) 272 0178 or website www.panasonic.co.nz
--



Sales Department:

Panasonic Australia Pty. Limited
1 Innovation Road, Macquarie Park NSW 2113, Australia

Sales Department:

Panasonic New Zealand Ltd.
350 Te Irirangi Drive, East Tamaki, Private Bag 14911 Panmure, Auckland, New Zealand
Phone: (09) 272 0100
Fax: (09) 272 0137

Panasonic System Networks Co., Ltd.
1-62, 4-chome, Minoshima, Hakata-ku, Fukuoka 812-8531, Japan

© Panasonic System Networks Co., Ltd. 2013

PNQX6042ZA
PNQX6042ZA

PNQX6042ZA TT0813MU0 (E)