

# Panasonic®

## Basic Operating Instructions

Digital Camera/  
Lens Kit/Double Zoom Lens Kit

Model No. **DMC-GF7K/DMC-GF7W**



# LUMIX

Please read these instructions carefully before using this product, and save this manual for future use.

**More detailed instructions on the operation of this camera are contained in “Operating Instructions for advanced features (PDF format)” in the supplied DVD.**



---

## Dear Customer,

We would like to take this opportunity to thank you for purchasing this Panasonic Digital Camera. Please read these Operating Instructions carefully and keep them handy for future reference. Please note that the actual controls and components, menu items, etc. of your Digital Camera may look somewhat different from those shown in the illustrations in these Operating Instructions.

### Carefully observe copyright laws.

- Recording of pre-recorded tapes or discs or other published or broadcast material for purposes other than your own private use may infringe copyright laws. Even for the purpose of private use, recording of certain material may be restricted.

---

## Information for Your Safety

### **WARNING:**

To reduce the risk of fire, electric shock or product damage,

- Do not expose this unit to rain, moisture, dripping or splashing.
- Use only the recommended accessories.
- Do not remove covers.
- Do not repair this unit by yourself. Refer servicing to qualified service personnel.

The socket outlet shall be installed near the equipment and shall be easily accessible.

### ■ Product identification marking

Product	Location
Digital Camera	Bottom
Battery charger	Bottom

## ■ About the battery pack

### **CAUTION**

- Danger of explosion if battery is incorrectly replaced. Replace only with the type recommended by the manufacturer.
  - When disposing of the batteries, please contact your local authorities or dealer and ask for the correct method of disposal.
- 
- Do not heat or expose to flame.
  - Do not leave the battery(ies) in a car exposed to direct sunlight for a long period of time with doors and windows closed.

### **Warning**

Risk of fire, explosion and burns. Do not disassemble, heat above 60 °C or incinerate.

## ■ About the battery charger

### **CAUTION!**

**To reduce the risk of fire, electric shock or product damage,**

- **Do not install or place this unit in a bookcase, built-in cabinet or in another confined space. Ensure this unit is well ventilated.**
- 
- The battery charger is in the standby condition when the AC power supply cord is connected. The primary circuit is always "live" as long as the power cord is connected to an electrical outlet.

---

## Cautions for Use

- Do not use any other USB connection cables except the supplied one or a genuine Panasonic USB connection cable (DMW-USBC1: optional).
- Use a "High Speed HDMI micro cable" with the HDMI logo.  
Cables that do not comply with the HDMI standards will not work.  
"High Speed HDMI micro cable" (Type D–Type A plug, up to 2 m long)
- Always use a genuine Panasonic AV cable (DMW-AVC1: optional).

### **Keep this unit as far away as possible from electromagnetic equipment (such as microwave ovens, TVs, video games etc.).**

- If you use this unit on top of or near a TV, the pictures and/or sound on this unit may be disrupted by electromagnetic wave radiation.
- Do not use this unit near cell phones because doing so may result in noise adversely affecting the pictures and/or sound.
- Recorded data may be damaged, or pictures may be distorted, by strong magnetic fields created by speakers or large motors.
- Electromagnetic wave radiation may adversely affect this unit, disturbing the pictures and/or sound.
- If this unit is adversely affected by electromagnetic equipment and stops functioning properly, turn this unit off and remove the battery or disconnect AC adaptor (DMW-AC10G: optional). Then reinsert the battery or reconnect AC adaptor and turn this unit on.

### **Do not use this unit near radio transmitters or high-voltage lines.**

- If you record near radio transmitters or high-voltage lines, the recorded pictures and/or sound may be adversely affected.

- 
- Before cleaning the camera, remove the battery or the DC coupler (DMW-DCC15: optional), or disconnect the power plug from the outlet.
  - Do not press the monitor with excessive force.
  - Do not press the lens with excessive force.
  - Do not spray the camera with insecticides or volatile chemicals.
  - Do not keep rubber or plastic products in contact with the camera for a long period of time.
  - Do not use solvents such as benzine, thinner, alcohol, kitchen detergents, etc., to clean the camera, since it may deteriorate the external case or the coating may peel off.
  - Do not leave the camera with the lens facing the sun, as rays of light from the sun may cause it to malfunction.
  - Always use the supplied cords and cables.
  - Do not extend the cords or the cables.
  - During access (image writing, reading and deleting, formatting etc.), do not turn this unit off, remove the battery, card or disconnect the AC adaptor (DMW-AC10G: optional). Furthermore, do not subject the camera to vibration, impact or static electricity.
  - The data on the card may be damaged or lost due to electromagnetic waves, static electricity or breakdown of the camera or the card. We recommend storing important data on a PC etc.
  - Do not format the card on your PC or other equipment. Format it on the camera only to ensure proper operation.
- 
- **The battery is not charged when the camera is shipped. Charge the battery before use.**
  - **The battery is a rechargeable lithium ion battery. If the temperature is too high or too low, the operating time of the battery will become shorter.**
  - The battery becomes warm after using and during and after charging. The camera also becomes warm during use. This is not a malfunction.
  - **Do not leave any metal items (such as clips) near the contact areas of the power plug or near the batteries.**
  - Store the battery in a cool and dry place with a relatively stable temperature: [Recommended temperature: 15 °C to 25 °C, Recommended humidity: 40%RH to 60%RH]
  - **Do not store the battery for a long time while fully charged.** When storing the battery for a long period of time, we recommend charging it once a year. Remove the battery from the camera and store it again after it has completely discharged.
- 

-If you see this symbol-



**Disposal of Old Equipment and Batteries  
Only for European Union and countries with recycle systems**

These symbols are only valid in the European Union and countries with recycle systems.

If you wish to discard this product, please contact your local authorities or dealer and ask for the correct method of disposal.

# Contents

<b>Information for Your Safety</b> .....	2
• Cautions for Use .....	4

---

---

## Preparation/Basic

---

---

<b>Care of the camera</b> .....	7
<b>Standard Accessories</b> .....	8
<b>Names and Functions of Components</b> .....	10
<b>Preparation</b> .....	12
• Attaching the Shoulder Strap .....	12
• Charging the Battery .....	13
• Inserting/Removing the Battery.....	13
• Inserting/Removing the Card (Optional).....	14
• Formatting the card (initialisation) .....	14
• Changing the Lens.....	15
• Setting Date/Time (Clock Set) .....	16
<b>Basic Operations</b> .....	17
• Monitor .....	17
• Shutter button (Taking pictures).....	17
• Mode dial (Selecting a Recording Mode) .....	18
• Function buttons (Assigning frequently used functions to the buttons).....	18
• Touch screen (Touch operations)...	19
• [REC. SETTING RESET] button (Resetting the recording settings).....	19
<b>Calling frequently-used menus instantly (Quick Menu)</b> .....	20
<b>Setting the Menu</b> .....	20

---

---

## Recording

---

---

<b>Taking Pictures using the Automatic Function (Intelligent Auto Mode)</b> .....	21
<b>Taking Pictures of Yourself ([Self Shot])</b> .....	23

<b>Taking Pictures with Manual Focus</b> .....	24
<b>Recording Motion Picture</b> .....	26
<b>Recording Snap Movies</b> .....	27

---

---

## Playback

---

---

<b>Playing Back Pictures</b> .....	28
<b>Playing Back Motion Pictures</b> .....	28
<b>Deleting Pictures</b> .....	29

---

---

## Wi-Fi

---

---

<b>What you can do with the Wi-Fi® function</b> .....	30
<b>Connecting to a smartphone/tablet</b> .....	31
<b>Controlling with a Smartphone/Tablet</b> .....	32

---

---

## Others

---

---

<b>About the supplied software</b> .....	34
<b>Monitor Display</b> .....	35
<b>Menu list</b> .....	37
<b>Troubleshooting</b> .....	39
<b>Specifications</b> .....	43
<b>Digital Camera Accessory System</b> .....	48
<b>Reading the Operating Instructions (PDF format)</b> .....	49
<b>Limited Warranty (ONLY FOR AUSTRALIA)</b> .....	50

# Care of the camera

## **Do not subject to strong vibration, shock, or pressure.**

- The lens, monitor, or external case may be damaged if used in the following conditions. It may also malfunction or image may not be recorded if you:
  - Drop or hit the camera.
  - Press hard on the lens or the monitor.

## **This camera is not dust/drip/water proof.**

### **Avoid using the camera in places with a lot of dust, water, sand, etc.**

- Liquid, sand and other foreign material may get into the space around the lens, buttons, etc. Be particularly careful since it may not just cause malfunctions, but it may also become irreparable.
  - Places with a lot of sand or dust.
  - Places where water can come into contact with this unit, such as when using it on a rainy day or at the beach.

## **Do not place your hands inside the mount of the digital camera body. Since the sensor unit is a precision apparatus, it may cause a malfunction or damage.**

### **■ About Condensation (When the lens or monitor is fogged up)**

- Condensation occurs when the ambient temperature or humidity changes. Be careful of condensation since it causes lens and monitor stains, fungus and camera malfunction.
- If condensation occurs, turn the camera off and leave it for about 2 hours. The fog will disappear naturally when the temperature of the camera becomes close to the ambient temperature.

### **About the firmware of your interchangeable lens**

For smoother recording, we recommend updating the firmware of the interchangeable lens to the latest version.

- **To view the latest information on the firmware or to download the firmware, visit the support site below:**

**<http://panasonic.jp/support/global/cs/dsc/>**

(This Site is English only.)

- To check the firmware version of the interchangeable lens, attach it to the camera body and select [Version Disp.] in the [Setup] menu.

## Standard Accessories

Check that all the accessories are supplied before using the camera.  
Product numbers correct as of January 2015. These may be subject to change.

### Digital Camera Body

(This is referred to as **camera body** in these operating instructions.)

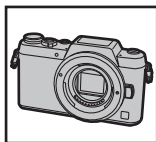

(○: Included, —: Not included)









	DMC-GF7K	DMC-GF7W	
1 Interchangeable Lens <sup>*1</sup>	○ <sup>*3</sup>	○ <sup>*3</sup>	○
2 Lens Cap	○ <sup>*2</sup>	○ <sup>*2</sup>	○ <sup>*2</sup>
3 Lens Rear Cap	—	—	○ <sup>*2</sup>
4 Lens Hood	—	—	○
5 Battery Pack (Indicated as <b>battery pack</b> or <b>battery</b> in the text) Charge the battery before use.			
6 Battery Charger (Indicated as <b>battery charger</b> or <b>charger</b> in the text)			
7 AC Cable			
8 USB Connection Cable			
9 DVD <ul style="list-style-type: none"> <li>• Software: Use it to install the software to your PC.</li> <li>• Operating Instructions for advanced features</li> </ul>			
10 Shoulder Strap			







\*1 This is referred to as **lens** in these operating instructions.

\*2 This is attached to the interchangeable lens at the time of purchase.

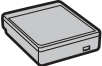
\*3 This is attached to the camera body at the time of purchase.



	DMC-GF7K	DMC-GF7W	
1	 H-FS12032	 H-FS12032	 H-FS35100
2	 VYF3562	 VYF3562	 SYF0014
3	—	—	 VFC4605
4	—	—	 SYA0025

5	 DMW-BLH7E	6	 DE-A98A	7	 K2CJ2YY00052	8	 K1HY08YY0031	9	 SFM0059
10	 VFC5071								

- SD Memory Card, SDHC Memory Card and SDXC Memory Card are indicated as **card** in the text.
- **The card is optional.**
- Description in these operating instructions is based on the interchangeable lens (H-FS12032).
- Consult the dealer or Panasonic if you lose the supplied accessories. (You can purchase the accessories separately.)

# Names and Functions of Components

## ■ Camera body

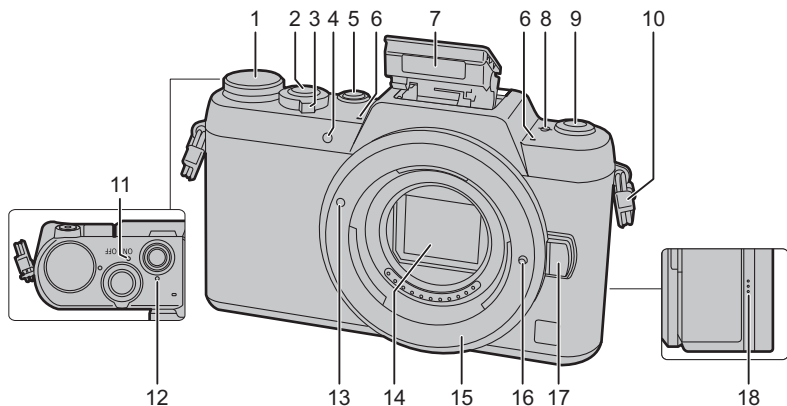

<b>1</b> Mode dial (P18)	
<b>2</b> Shutter button (P17)	
<b>3</b> Camera ON/OFF switch (P16)	
<b>4</b> Self-timer indicator/ AF Assist Lamp	
<b>5</b> Intelligent Auto button (P21)	
<b>6</b> Stereo microphone • Be careful not to cover the microphone with your finger. Doing so may make sound difficult to record.	
<b>7</b> Flash	
<b>8</b> Focus distance reference mark	
<b>9</b> [Wi-Fi] button (P31)/[Fn1] button (P18)	
<b>10</b> Shoulder strap eyelet (P12)	
	<b>11</b> Status indicator (P16)/ Wi-Fi® connection lamp • The lamp lights green when the camera is turned on, and lights blue when it is connected to Wi-Fi.
	<b>12</b> Intelligent Auto lamp (P21)
	<b>13</b> Lens fitting mark (P15)
	<b>14</b> Sensor
	<b>15</b> Mount
	<b>16</b> Lens lock pin
	<b>17</b> Lens release button (P15)
	<b>18</b> Speaker • Be careful not to cover the speaker with your finger. Doing so may make sound difficult to hear.

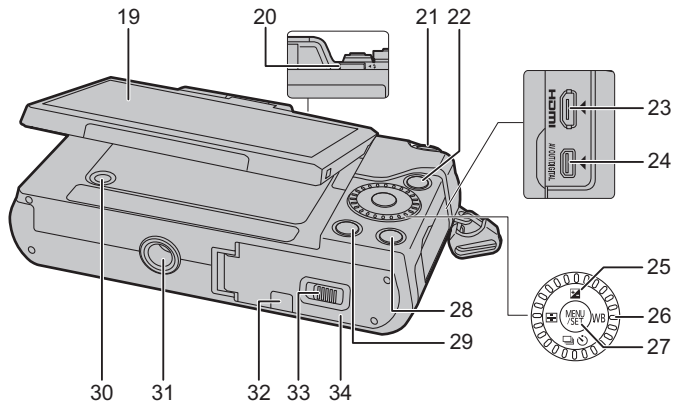

<b>19</b> Touch screen (P19)/monitor (P17)	<b>28</b> [DISP.] button • Each time this is pressed, the display on the monitor is switched.
<b>20</b> Flash open lever • The flash opens, and recording with the flash becomes possible.	<b>29</b> [ ] (Delete) button (P29)/ [Q.MENU/ ] (Quick Menu/Return) button (P20)
<b>21</b> Motion picture button (P26)	<b>30</b> [REC. SETTING RESET] button (P19) • Use this button to restore the default recording settings.
<b>22</b> [ ] (Playback) button (P28)	<b>31</b> Tripod mount • It may not be possible to attach and securely fasten a tripod with a screw length of 5.5 mm or more to the camera. Doing so may also damage the camera.
<b>23</b> [HDMI] socket	<b>32</b> DC coupler cover • When using an AC adaptor, ensure that the Panasonic DC coupler (DMW-DCC15: optional) and AC adaptor (DMW-AC10G: optional) are used. • Always use a genuine Panasonic AC adaptor (DMW-AC10G: optional). • When using an AC adaptor, use the AC cable supplied with the AC adaptor.
<b>24</b> [AV OUT/DIGITAL] socket	<b>33</b> Release lever (P13)
<b>25</b> Cursor buttons • These operating instructions expresses the up, down, left, and right of the cursor button as ▲/▼/◀/▶. ▲/[ ] (Exposure Compensation) ▶/[WB] (White Balance) ◀/[ ] (Auto Focus Mode) ▼/[ ] (Drive mode) – Single/Burst/Auto bracket/Self-timer	<b>34</b> Card/Battery door (P13)
<b>26</b> Control dial • In these operating instructions, turning the control dial is indicated as follows.	
<b>27</b> [MENU/SET] button (P20)	

## ■ Lens

### H-FS12032

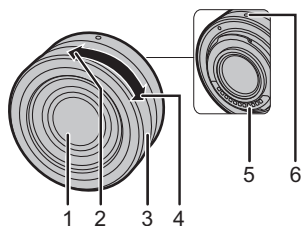

- 1 Lens surface
- 2 Tele
- 3 Zoom ring
- 4 Wide
- 5 Contact point
- 6 Lens fitting mark (P15)
- 7 Focus ring

### H-FS35100

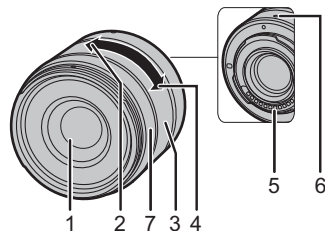

- The interchangeable lens (H-FS12032) does not have a focus ring, but you can use manual focus by operating the camera. Refer to P24 for details.

## Preparation

- Check that the camera is turned off.

### Attaching the Shoulder Strap

- We recommend attaching the shoulder strap when using the camera to prevent it from dropping.

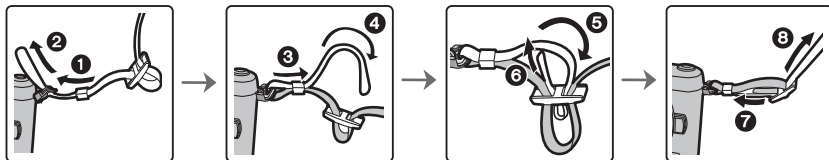

- Perform steps ① to ⑧ and then attach the other side of the shoulder strap.
- Use the shoulder strap around your shoulder.
  - Do not wrap the strap around your neck.
  - It may result in injury or accident.
- Do not leave the shoulder strap where an infant can reach it.
  - It may result in an accident by mistakenly wrapping around the neck.

## Charging the Battery

The battery that can be used with this unit is **DMW-BLH7E**.

- 1 Attach the battery paying attention to the direction of the battery.
- 2 Connect the AC cable.
  - The [CHARGE] indicator (A) lights up and charging begins.

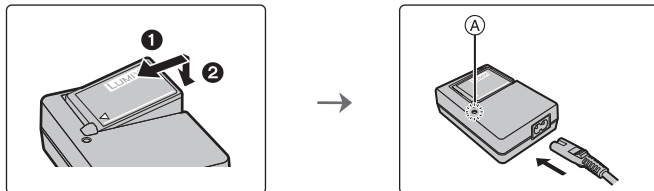

### ■ About the [CHARGE] indicator

**On:** Charging.

**Off:** Charging has completed.

(Disconnect the charger from the electrical socket and detach the battery after charging is completed.)

### • When the [CHARGE] indicator flashes

- The battery temperature is too high or too low. It is recommended to charge the battery again in an ambient temperature of between 10 °C and 30 °C.
- The terminals of the charger or the battery are dirty. In this case, wipe them with a dry cloth.

### ■ Charging time

#### Charging time

Approx. 130 min

- The indicated charging time is for when the battery has been discharged completely. The charging time may vary depending on how the battery has been used. The charging time for the battery in hot/cold environments or a battery that has not been used for a long time may be longer than normal.

## Inserting/Removing the Battery

- Always use genuine Panasonic batteries (DMW-BLH7E).
- If you use other batteries, we cannot guarantee the quality of this product.

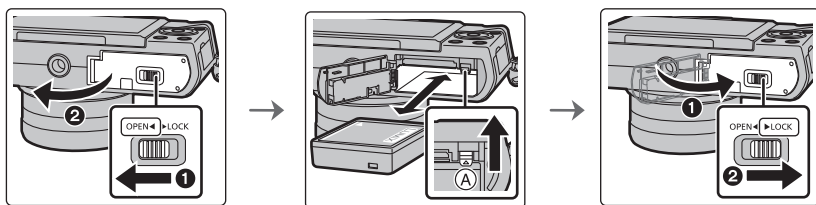

- Being careful about the battery orientation, insert all the way until you hear a locking sound and then check that it is locked by lever (A). Pull the lever (A) in the direction of the arrow to remove the battery.

## Inserting/Removing the Card (Optional)

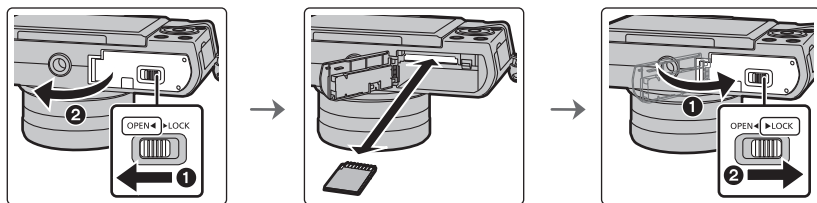

- Push it securely all the way until you hear a “click” while being careful about the direction in which you insert it.

To remove the card, push the card until it clicks, then pull the card out upright.

### ■ About cards that can be used with this unit

SD Memory Card (8 MB to 2 GB)

SDHC Memory Card (4 GB to 32 GB)

SDXC Memory Card (48 GB, 64 GB)

### ■ About the motion picture recording and SD speed class

Confirm the SD Speed Class (the speed standard regarding continuous writing) on a card label etc. when you record a motion picture. Use a card with SD Speed Class with “Class 4” or more for [AVCHD]/[MP4] motion picture recording.

e.g.:

CLASS **4**      **4**

- Please confirm the latest information on the following website.

<http://panasonic.jp/support/global/cs/dsc/>

(This Site is English only.)

- Keep the Memory Card out of reach of children to prevent swallowing.

## Formatting the card (initialisation)

Format the card before recording a picture with this unit.

**Since data cannot be recovered after formatting, make sure to back up necessary data in advance.**

**Select [Format] in the [Setup] menu.**

- Confirmation screen is displayed. It is executed when [Yes] is selected.

## Changing the Lens

- When attaching or detaching the interchangeable lens (H-FS12032/H-FS35100), retract the lens barrel.
- Change lenses where there is not a lot of dirt or dust.

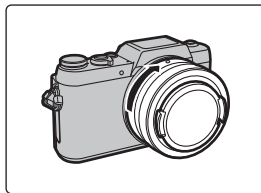
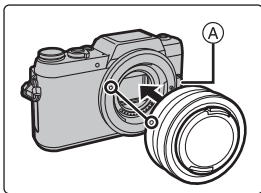

- Do not press the lens release button (A) when you attach a lens.

### ■ Detaching the lens

- 1 Attach the lens cap.
- 2 While pressing on the lens release button (B), rotate the lens toward the arrow until it stops and then remove.

- Hold and rotate the base area of the lens (C).

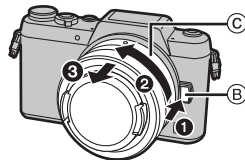

### ■ Extending/retracting the lens [when the interchangeable lens (H-FS12032/H-FS35100) is attached]

#### How to Extend the Lens

Rotate the zoom ring in the direction of arrow ① from position (A) (the lens is retracted) to position (B) [12 mm to 32 mm (H-FS12032), 35 mm to 100 mm (H-FS35100)] to extend the lens.

- When the lens barrel is retracted, images cannot be recorded.

Ⓒ The lens is retracted

#### How to Retract the Lens

Rotate the zoom ring in the direction of arrow ② from position (B) [12 mm to 32 mm (H-FS12032), 35 mm to 100 mm (H-FS35100)] to position (A) to retract the lens.

- The zoom ring will seem to click into the 12 mm position (H-FS12032) or 35 mm position (H-FS35100), but continue to rotate the lens until it reaches position (A).

- When you are not recording images, we recommend that you retract the lens.

Ⓓ The lens is extended

Example: H-FS12032

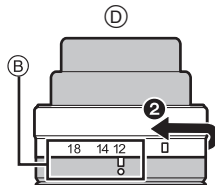
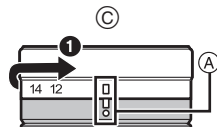

## Setting Date/Time (Clock Set)

- The clock is not set when the camera is shipped.

**1 Turn the camera on.**

- When the camera is turned on, the status indicator **1** lights up green.

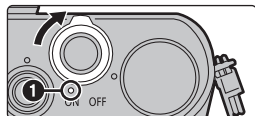

**2 Press [MENU/SET].**

**3 Press ◀/▶ to select the items (year, month, day, hour, minute), and press ▲/▼ to set.**

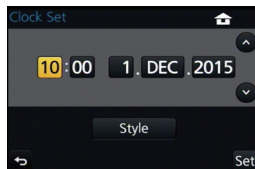

**4 Press [MENU/SET] to set.**

- Confirmation screen is displayed. Press [MENU/SET].
- A message prompting you to set [Home] in [World Time] will be displayed. Press [MENU/SET].

**5 Press ◀/▶ to select the home area, and then press [MENU/SET].**





# Basic Operations

## Monitor

You can adjust the angle of the monitor.

- **Be careful not to catch your finger, etc. in the monitor.**
- **When rotating the monitor, be careful not to apply too much force. This may cause scratches and malfunctions.**
- When not using this unit, close the monitor completely back to the original position.



## Shutter button (Taking pictures)

The shutter button works in two steps. To take a picture, press it.

### Press the shutter button halfway to focus.

- (A) Aperture value
- (B) Shutter speed
- (C) Focus indication

- Aperture value and shutter speed are displayed.  
(It will flash in red if the correct exposure is not achieved, except when set to flash.)
- Once the subject is in focus, the focus indication is displayed.  
(When the subject is not in focus, the indication flashes)

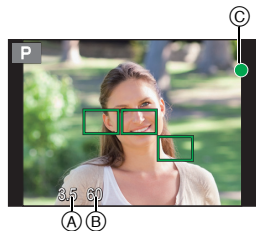
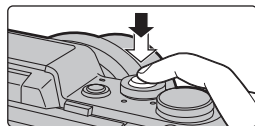

### Press the shutter button fully (push it in further), and take the picture.

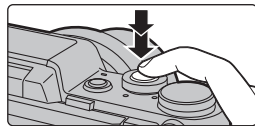

- **When the image is correctly focused, the picture will be taken, since the [Focus/Release Priority] is set initially to [FOCUS].**
- The focus range is different depending on the lens used.
- Even during menu operation or image playback, if you press the shutter button halfway, you can instantly set the camera ready for recording.

## Mode dial (Selecting a Recording Mode)

Select the mode by rotating the mode dial.

- Rotate the mode dial slowly to select the desired mode.

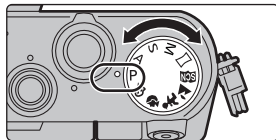

### **P** Programme AE Mode

Records at the aperture value and shutter speed set by the camera.

### **A** Aperture-Priority AE Mode

The shutter speed is automatically determined by the aperture value you set.

### **S** Shutter-Priority AE Mode

The aperture value is automatically determined by the shutter speed you set.

### **M** Manual Exposure Mode

The exposure is adjusted by the aperture value and the shutter speed which are manually adjusted.

### Panorama Shot Mode

This mode allows you to take panorama pictures.

### Scene Guide Mode

This mode allows you to take pictures that match the scene being recorded.

### Scenery Mode

This mode allows you to take pictures of scenery.

### Child Mode

This mode allows you to take pictures of children.

### Portrait Mode

This mode allows you to take portrait pictures.

### Creative Control Mode

Record while checking the image effect.

## Function buttons (Assigning frequently used functions to the buttons)

You can assign recording functions, etc. to specific buttons and icons.

### 1 Select the menu.

**MENU** → **fC [Custom]** → **[Fn Button Set]**

### 2 Press **▲/▼** to select the function button you want to assign a function to and then press **[MENU/SET]**.

### 3 Press **▲/▼** to select the function you want to assign and then press **[MENU/SET]**.

- Some functions cannot be assigned depending on the function button.

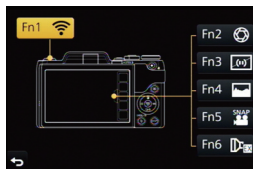

## Touch screen (Touch operations)

Touch screen of this unit is capacitive. Touch the panel directly with your bare finger.

### ■ Touch

To touch and release the touch screen.

- When selecting features using the touch screen, be sure to touch the centre of the desired icon.



### ■ Drag

A movement without releasing the touch screen.

This can also be used to move to the next image during playback, etc.



### ■ Pinch (enlarge/reduce)

Pinch the touch screen apart (enlarge) or together (reduce) with two fingers.



## [REC. SETTING RESET] button (Resetting the recording settings)

You can restore the default recording settings by pressing this button.

Try pressing this button when the function in use stops working or is not working as it should.

**While the recording screen is displayed:**

**Press [REC. SETTING RESET].**

- Confirmation screen is displayed. It is executed when [Yes] is selected.
- When the recording settings are reset, the following setting is also reset:
  - Drive mode
- The [Face Recog.] and [Profile Setup] settings are not reset.

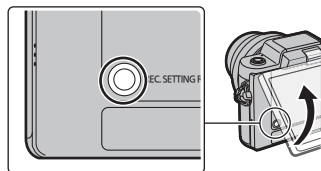

# Calling frequently-used menus instantly

## (Quick Menu)

By using the Quick Menu, some of the menu settings can be easily found.

- The features that can be adjusted using Quick Menu are determined by the mode or a display style the camera is in.

**1** Press [Q.MENU/↵] to display the Quick Menu.

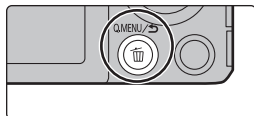

**2** Rotate the control dial to select the menu item, and press ▼ or ▲.

**3** Rotate the control dial to select the setting.

**4** Press [Q.MENU/↵] to exit the menu once the setting is complete.

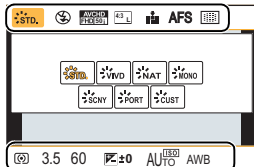

- You can close the menu by pressing the shutter button halfway.

## Setting the Menu

**1** Press [MENU/SET].

**2** Press ▲/▼ of the cursor button to select the menu item and press [MENU/SET].

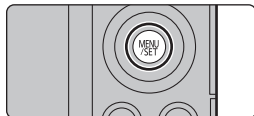

**3** Press ▲/▼ of the cursor button to select the setting and press [MENU/SET].

- Depending on the menu item, its setting may not appear or it may be displayed in a different way.

### ■ Close the menu

Press [Q.MENU/↵] or press the shutter button halfway.



### ■ Switching to other menus

e.g.: Switching to the [Setup] menu from [Rec] menu.

**1** Press ◀.

**2** Press ▲/▼ to select a menu selector icon, such as [↵].

**3** Press [MENU/SET].

- Select a menu item next and set it.



# Taking Pictures using the Automatic Function

## (Intelligent Auto Mode)

Recording Mode:  

In this mode, the camera makes the optimal settings for the subject and scene, so we recommend it when you wish to leave the settings to the camera and record without thinking about them.

### 1 Press .

- The camera will switch to either the most recently used of Intelligent Auto Mode or Intelligent Auto Plus Mode. At the time of purchase, the mode is set to Intelligent Auto Plus Mode.
- The Intelligent Auto lamp lights up when you set the camera to Intelligent Auto Mode.
- If you press the button again, the Intelligent Auto lamp will go off, and the camera will be set to the Recording Mode selected with the mode dial.

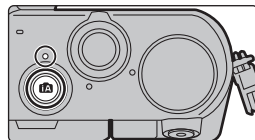



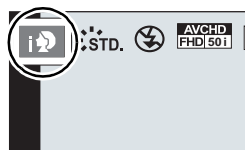

### 2 Align the screen with the subject.

- When the camera identifies the optimum scene, the icon of the scene concerned is displayed in blue for 2 seconds, after which its colour changes to the usual red. (Automatic scene detection)



## ■ Switching between Intelligent Auto Plus Mode and Intelligent Auto Mode

- 1 Press **[MENU/SET]**.
- 2 Press **◀**.
- 3 Press **▲/▼** to select the  or  tab.
- 4 Press **▶** to select  or  and then press **[MENU/SET]**.
  - If **[DISP.]** is pressed, the description of the selected mode will be displayed.



## Recording night scenes ([iHandheld Night Shot])

When [iHandheld Night Shot] is set to [ON] and  is detected while taking handheld night shots, pictures of the night scenery will be taken at a high burst speed and composed into a single picture.

This mode is useful if you want to take stunning night shots with minimal jitter and noise, without using a tripod.

**[MENU]** →  **[Rec]** → **[iHandheld Night Shot]** → **[ON]/[OFF]**

## Combining pictures into a single picture with rich gradation ([iHDR])

When [iHDR] is set to [ON] and there is, for example, strong contrast between the background and the subject, multiple still pictures are recorded with differing exposures and combined to create a single still picture rich in gradation.

[iHDR] works automatically as needed. When it does, [HDR] is displayed on the screen.

**MENU** →  **[Rec]** → **[iHDR]** → **[ON]/[OFF]**

## Taking a picture with a blurred background (Defocus Control)

**Recording Mode:**  

You can easily set the blurriness of the background while checking the screen.

### 1 Press ▲ to display the setting screen.

- Each time ▲ is pressed in Intelligent Auto Plus Mode, the camera switches between brightness setting operation, Defocus Control operation, and normal operation.
- Each time ▲ is pressed in Intelligent Auto Mode, the camera switches between Defocus Control operation and normal operation.

### 2 Rotate the control dial to set the blurriness.



## Recording images by changing the brightness or colour tone

**Recording Mode:** 

This mode enables you to change the brightness and colour tone to your preferred settings from the ones set by the camera.

### ■ Setting brightness

#### 1 Press ▲ to display the setting screen.

- Each press of ▲ switches among brightness setting, Defocus Control and end operation.

#### 2 Rotate the control dial to adjust brightness.

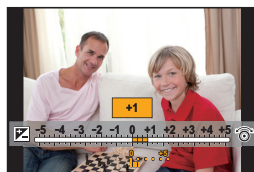

### ■ Setting colour

#### 1 Press ► to display the setting screen.

#### 2 Rotate the control dial to adjust colour.

- This will adjust the colour of the image from a reddish colour to a bluish colour.
- Press [MENU/SET] to return to the recording screen.



# Taking Pictures of Yourself ([Self Shot])

Applicable modes:   P A S M     

If you rotate the monitor, Self Shot Mode is activated.  
You can easily take pictures of yourself while looking at the screen.





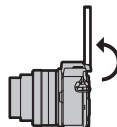



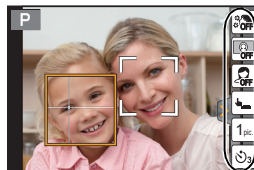

















## 1 Rotate the monitor as shown in the figure.

- When you rotate the monitor, a mirror image will be displayed on the monitor.



## 2 Touch the item.



 ([Soft Skin])	Makes people's faces look brighter and their skin tones look softer. [  ] (Off), [  ] (Low), [  ] (Medium)*, [  ] (High)*
 ([Defocusing])	Blurs the background of detected faces. (Note that the faces further back in the image will be blurred with the background.) [  ] (Off), [  ] (On)*
 ([Slimming Mode])	Makes people look slimmer. [  ] (Off), [  ] (Low), [  ] (High)
 ([Shutter])	Sets the way the shutter is released. [  ] (Shutter button only), [  ] (Touch), [  ] (Buddy), [  ] (Face)
 ([Shots])	Sets the number of pictures to be taken in succession. [  ] (1 picture)/[  ] (2 pictures)/[  ] (3 pictures)/[  ] (4 pictures)
 ([Countdown])	Takes a picture after a countdown. [  ] ([Off])/[  ] (3)/[  ] (10)

\* Display of the recording screen will be delayed more than usual and the screen will look as if frames are dropping.

## 3 Decide on your poses while looking at the monitor.

## 4 Press the shutter button halfway to focus and then press it fully to take the picture.

- Look at the lens when recording.
- Be careful not to look at the light from the flash and the AF Assist Lamp directly.

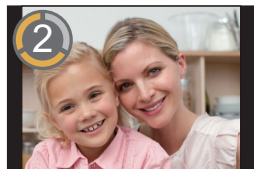

# Taking Pictures with Manual Focus

Applicable modes: 

Use this function when you want to fix the focus or when the distance between the lens and the subject is determined and you do not want to activate Auto Focus.

## When using an interchangeable lens (H-FS12032) with no focus ring

Press **▶**: Focuses on close-up subjects

Press **◀**: Focuses on distant subjects

**(A)** Slide bar

- These operations are possible only on the focus adjustment screen.
- Pressing and holding **◀/▶** will increase the focus speed.
- Focus can also be adjusted by dragging the slide bar.

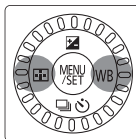

### 1 Select the menu.

**MENU** →  **[Rec]** → **[Focus Mode]** → **[MF]**

### 2 Press **◀** ().

### 3 Press **▲/▼/◀/▶** to adjust the focus position, and press **[MENU/SET]**.

- The assist screen is displayed, enlarging the area. (MF Assist)
- Pressing **[DISP.]** resets the focus position back to the centre.



## 4 Adjust the focus.

- (A) Indicator for  $\infty$  (infinity)
  - (B) MF Assist (enlarged screen)
  - (C) Peaking
  - (D) MF Guide
- The in-focus portions will be highlighted. (Peaking)
  - You can check whether the point of focus is to the near side or to the far side. (MF Guide)

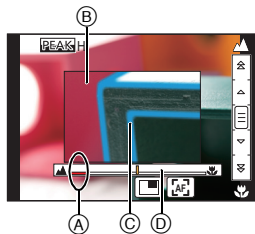

You can perform the following operations:

Button operation	Touch operation	Description of operation
▲/▼/◀/▶*	<b>Dragging</b>	Moves the enlarged area
—	<b>Pinching out/in</b>	Enlarges/reduces the screen in small steps.
	—	Enlarges/reduces the screen in large steps.
—		Switches the enlarged display (windowed/full screen)
<b>[DISP.]*</b>	<b>[Reset]*</b>	Resets the area to be enlarged back to the centre.

- \* When using an interchangeable lens with no focus ring, you can perform these operations after pressing ▼ to display the screen that lets you set the area to be enlarged.

## 5 Press the shutter button halfway.

- The assist screen will close. The recording screen will be displayed.
- You can also close the assist screen by pressing [MENU/SET].

# Recording Motion Picture

**Applicable modes:**   **P** **A** **S** **M**     

This camera can record full high definition motion pictures compatible with the AVCHD format or motion pictures recorded in MP4.

Audio will be recorded in stereo.

## 1 Start recording by pressing the motion picture button.

- (A) Elapsed recording time
- (B) Available recording time

- Recording of motion picture appropriate for each mode is possible.
- The recording state indicator (red) (C) will flash while recording motion pictures.
- If approximately 1 minute elapses without an operation being performed, part of the display will disappear. Press [DISP.] or touch the monitor to make the display reappear.
- Release the motion picture button right after you press it.

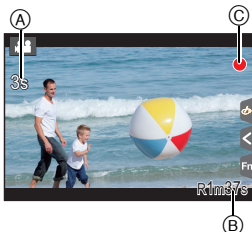
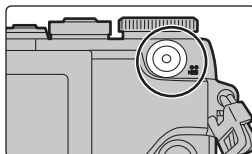

## 2 Stop the recording by pressing the motion picture button again.

- Still picture recording is also possible during the motion picture recording by fully pressing the shutter button.

- When a high ambient temperature, continuous recording or other conditions cause the camera to overheat, the following restrictions will occur to protect the camera. Wait until the camera cools down.
  - Continuous recording, motion picture recording, and the Wi-Fi connection will be temporarily disabled.
  - If you continue recording even when [  ] is flashing on the screen, a message will be displayed and the camera will turn off automatically.
- It is recommended to use a fully charged battery or AC adaptor (DMW-AC10G: optional) when recording motion pictures.
- If while recording motion pictures using the AC adaptor (DMW-AC10G: optional) the power supply is cut off due to a power cut or if the AC adaptor (DMW-AC10G: optional) is disconnected etc., the motion picture will not be recorded.
- Maximum time to record motion pictures continuously with [MP4] is 29 minutes 59 seconds or up to 4 GB.  
(For [FHD/28M/50p]/[FHD/20M/25p] in [MP4] format, the file size is large and so the recordable time will drop below 29 minutes 59 seconds.)

# Recording Snap Movies

Applicable modes: 

You can specify the recording time in advance and record motion pictures casually like you take snapshots. The function also allows you to shift a focus at the start of recording and add fade in/out effects in advance.

- Motion pictures will be recorded with [FHD/20M/25p] in [MP4].
- Using the smartphone/tablet app “Panasonic Image App”, you can combine motion pictures recorded with the camera. Music can be added and various editing operations can be performed when you combine them. In addition, you can send the combined motion picture to a web service. (P33)

## 1 Select the menu. (P20)

**MENU** →  **[Motion Picture]** → **[Snap Movie]**

## 2 Select [SET] with ▲/▼, and then press [MENU/SET].

## 3 Press ▲/▼ to select an item and then press [MENU/SET].

<b>[Record time]</b>	Sets the recording time of motion pictures.
<b>[Pull Focus]</b>	Allows dramatic imaging expression by shifting focus gradually at the start of recording.
<b>[Fade]</b>	Adds a fade-in (gradual appearance) effect to an image and audio as recording starts or adds a fade-out (gradual disappearance) effect to them as recording ends.

## 4 Press [Q.MENU/↵].

## 5 Press [MENU/SET].

## 6 Select [ON] with ▲/▼, and then press [MENU/SET].

- Press the shutter button halfway to exit the menu.
- If [Pull Focus] is set to [ON], set its focus.

## 7 Start recording by pressing the motion picture button.

- Ⓐ Elapsed recording time
- Ⓑ Set recording time
- Release the motion picture button right after you press it.
- You cannot stop motion picture recording in the middle. The recording will stop automatically when the set recording time has elapsed.

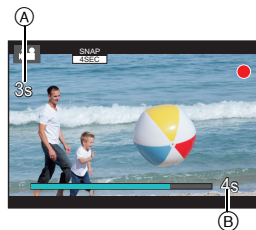

### ■ To deactivate Snap Movie

Select [OFF] in step 2.

• For details, refer to the “Operating Instructions for advanced features (PDF format)”.

## Playing Back Pictures

1 Press [▶].

2 Press ◀/▶.

◀: Play back the previous picture

▶: Play back the next picture

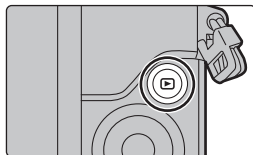

### Sending an image to a web service

If you press ▼ when displaying images one by one, you can easily send an image to a web service.

- For details, refer to the “Operating Instructions for advanced features (PDF format)”.

## Playing Back Motion Pictures

This unit was designed to play motion pictures using the AVCHD, MP4 and QuickTime Motion JPEG formats.





- Motion pictures are displayed with the motion picture icon ().

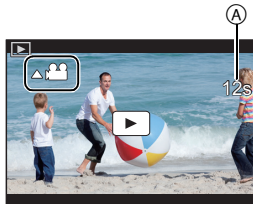



Press ▲ to play back.

Ⓐ Motion picture recording time



### ■ Operations during Motion Picture Playback

Button operation	Touch operation	Description of operation
▲		Play/Pause
◀		Fast rewind*
		Frame-by-frame rewind (while pausing)
		Reduce volume level

Button operation	Touch operation	Description of operation
▼		Stop
▶		Fast forward*
		Frame-by-frame forward (while pausing)
		Increase volume level

\* The fast forward/rewind speed increases if you press ▶/◀ again.

- If you press [MENU/SET] during a pause, you can create a picture from a motion picture.

# Deleting Pictures

Once deleted, pictures cannot be recovered.

## To delete a single picture

### 1 In Playback Mode, select the picture to delete and then press [ ].

- The same operation can be performed by touching [  ].

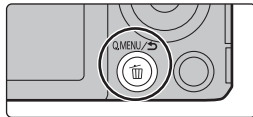

### 2 Press ▲ to select [Delete Single] and then press [MENU/SET].

- Confirmation screen is displayed.  
Picture is deleted by selecting [Yes].

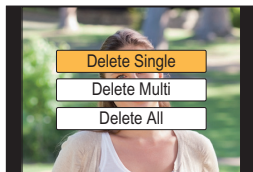

## To delete multiple pictures (up to 100\*) or all the pictures

- \* Picture groups are treated as a single picture.  
(All the pictures in the selected picture group will be deleted.)

### 1 In Playback Mode, press [ ].

### 2 Press ▲/▼ to select [Delete Multi] or [Delete All] and then press [MENU/SET].

- [Delete All] → Confirmation screen is displayed.  
Pictures are deleted by selecting [Yes].
- It is possible to delete all pictures except the ones set as favourite when [All Delete Except Favorite] is selected with the [Delete All] set.

### 3 (When [Delete Multi] is selected) Press ▲/▼/◀/▶ to select the picture, and then press [MENU/SET] to set. (Repeat this step.)

- [  ] appears on the selected pictures.  
If [MENU/SET] is pressed again, the setting is cancelled.

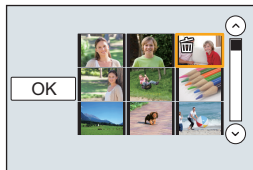

### 4 (When [Delete Multi] is selected)

Press ◀ to select [OK], and then press [MENU/SET] to execute.

- Confirmation screen is displayed.  
Pictures are deleted by selecting [Yes].

## What you can do with the Wi-Fi® function

- The camera cannot be used to connect to a public wireless LAN connection.

### Controlling with a Smartphone/Tablet (P32)

- Recording with a smartphone (P32)
- Playing back pictures in the camera (P32)
- Saving images stored in the camera (P32)
- Sending images to an SNS (P32)
- Writing location information on images stored in the camera (P33)
- Combining motion pictures recorded with Snap Movie according to your preference on a smartphone/tablet (P33)



### Installing the smartphone/tablet app “Image App”

- OS
    - App for Android™: Android 2.3.3 or higher\*
    - Search the Google Play™ Store for “Panasonic Image App” or “LUMIX”, and install the app.
    - App for iOS: iOS 6.0 or higher (Please note that the iPhone 3GS is not supported.)
    - Search the App Store™ for “Panasonic Image App” or “LUMIX”, and install the app.
  - \* Connecting to this unit with [Wi-Fi Direct] requires Android OS 4.0 or higher and Wi-Fi Direct® support.
  - Use the latest version.
  - Supported OSs are current as of January 2015 and are subject to change.
  - Read the [Help] in the “Image App” menu for further details on how to operate.
  - The service may not be able to be used properly depending on the type of smartphone being used.
- For information on the “Image App”, refer to the support site below.  
<http://panasonic.jp/support/global/cs/dsc/>  
 (This Site is English only.)
- When downloading the app on a mobile network, high packet communication fees may be incurred depending on the details of your contract.

- **Displaying pictures on a TV**
- **Printing Wirelessly**
- **When sending images to AV device**
- **When sending images to PC**
- **Using Web services**



These operating instructions refer to both smartphones and tablets as “smartphones” from this point on unless noted otherwise.

- For details, refer to the “Operating Instructions for advanced features (PDF format)”.

# Connecting to a smartphone/tablet

For both iOS devices (iPhone/iPod touch/iPad) and Android devices

## Connecting without entering the password

You can directly connect the camera to a smartphone with ease by pressing [Wi-Fi].

- 1 Press [Wi-Fi] on the camera.
- 2 Turn on the Wi-Fi function in the setting menu of the smartphone.
- 3 Select the SSID displayed on the screen of the camera.
  - A SSID
- 4 On the smartphone, start “Image App”.
  - The connection confirmation screen is displayed on the camera. Select [Yes]. (Only when connecting for the first time)

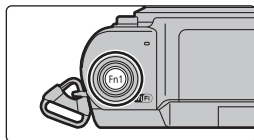

When [Wi-Fi Password] is set to the default setting [OFF], third parties may intercept Wi-Fi radio waves and collect the content of communications. Set [Wi-Fi Password] to [ON] to enable the password.

- For details, refer to the “Operating Instructions for advanced features (PDF format)”.

For both iOS devices (iPhone/iPod touch/iPad) and Android devices

## Terminating the connection

After use, terminate the connection to the smartphone.

- 1 Press [Wi-Fi] on the camera.  
[Terminate the Connection] → [Yes]
- 2 On the smartphone, close “Image App”.
 

(If you are using an iOS device)  
On the screen of “Image App”, press the home button to close the app.

(If you are using an Android device)  
On the screen of “Image App”, press the return button twice to close the app.

# Controlling with a Smartphone/Tablet

## Taking images via a smartphone/tablet (remote recording)

- 1 Connect to a smartphone. (P31)
- 2 Operate the smartphone.

① Select [  ].

② Record an image.

- The recorded images are saved in the camera.
- Some settings are not available.

- When a high ambient temperature, continuous recording or other conditions cause the camera to overheat, the following restrictions will occur to protect the camera. Wait until the camera cools down.

- Continuous recording, motion picture recording, and the Wi-Fi connection will be temporarily disabled.
- If you continue recording even when [  ] is flashing on the screen, a message will be displayed and the camera will turn off automatically.



### ■ Taking a picture while jumping

When you hold your smartphone and jump, the camera's shutter can be released automatically as the smartphone detects the peak of the jump. This function is convenient for taking a picture while jumping.

### Operate the smartphone.

[  ] → [Live Control Settings] → [Jump Snap] → Select the sensitivity.

- We recommend that you take test pictures to determine the camera's angle and how hard you jump and to make any desired adjustments.
- For details, refer to the help section in the "Image App" menu.

## Playing back images in the camera

- 1 Connect to a smartphone. (P31)
- 2 Operate the smartphone.

① Select [  ].

② Touch the image to enlarge it.



## Saving images stored in the camera/ Sending images in the camera to an SNS

- 1 Connect to a smartphone. (P31)
- 2 Operate the smartphone.

① Select [  ].

② Touch and hold an image, and drag it to save it or to send it to an SNS, etc.

- The function can be assigned to the top, bottom, left or right according to your preference.
- Pictures in RAW format and motion pictures of [AVCHD] cannot be saved.







## Adding location information to images stored in the camera from a smartphone/tablet

You can send location information acquired with a smartphone to the camera. After sending the information, you can also write it on images stored in the camera.

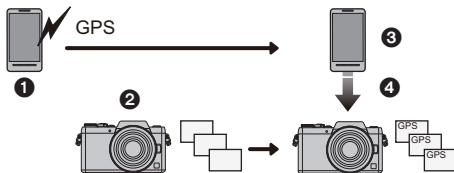

- 1 Start recording location information
- 2 Start recording images
- 3 Finish recording the location information
- 4 Sending and writing location information



### ■ Operate the smartphone

- 1 Connect to a smartphone. (P31)
- 2 Select [  ].
- 3 Select [Geotagging].
- 4 Select an icon.



	Start/stop recording location information.
	Sending and writing location information. <ul style="list-style-type: none"> <li>• Follow the on-screen messages to operate the smartphone.</li> <li>• Images with location information are indicated with [ GPS ].</li> </ul>

## Combining motion pictures recorded with Snap Movie according to your preference on a smartphone/tablet

Using a smartphone, you can combine motion pictures recorded with the camera's [Snap Movie] function (P27). Music can be added to motion pictures to be combined. In addition, you can save the combined motion picture or upload it on a web service.

- 1 Connect to a smartphone. (P31)
- 2 Operate the smartphone.

- 1 Select [  ].
- 2 Select [Snap Movie].



- [Snap Movie] motion pictures with recent recording dates will be randomly selected and automatically sent to the smartphone.
  - When motion pictures with recent recording dates are not available, a screen that lets you select motion pictures will be displayed. Select motion pictures and send them.
- 3 Edit the motion pictures.
    - Read the [Help] in the "Image App" menu for further details on how to operate.

- [Snap Movie] of the "Image App" requires a smartphone that supports Android OS 4.3 or higher.
- The iPhone 4 and iPod touch (4th generation) do not support [Snap Movie] of the "Image App".

## About the supplied software

The supplied DVD includes the following software.  
Install the software on to your computer before use.

- **PHOTOfunSTUDIO 9.6 PE (Windows Vista/Windows 7/Windows 8/Windows 8.1)**
- **SILKYPIX Developer Studio 4.2 SE**  
(Windows Vista/Windows 7/Windows 8/Windows 8.1, Mac OS X v10.5 to v10.10)

For details on how to use the SILKYPIX Developer Studio, refer to the “Help” or the Ichikawa Soft Laboratory’s support website:  
<http://www.isl.co.jp/SILKYPIX/english/p/support/>

- **LoiLoScope 30 day full trial version (Windows Vista/Windows 7/Windows 8/Windows 8.1)**

For more information on how to use LoiLoScope, read the LoiLoScope manual available for download at the link below.  
**Manual URL:** <http://loilo.tv/product/20>

### ■ Installing supplied software

- Before inserting the DVD, close all running applications.

#### 1 Check the environment of your PC.

- For details about information such as the operating environment or operating method, refer to the “Operating Instructions for advanced features (PDF format)” or the operating instructions for the respective software programmes.

#### 2 Insert the DVD with the supplied software.

- If the automatic playback screen is displayed, you can display the menu by selecting and executing [Launcher.exe].
- In Windows 8/Windows 8.1, you can display the menu by clicking a message that is displayed after inserting the DVD and then selecting and executing [Launcher.exe].
- You can also display the menu by double-clicking [SFMXXXX] in [Computer] (XXXX differs depending on the model).

#### 3 Click [Applications].

#### 4 Click on the [Recommended Installation] on the install menu to install.

- Proceed with installation according to messages appearing on the screen.

- The software compatible with your PC will be installed.
- On the Mac, SILKYPIX can be installed manually.

- 1 Insert the DVD with the supplied software.
- 2 Double-click the application folder on the DVD.
- 3 Double-click on the automatically displayed folder.
- 4 Double-click the icon in the application folder.



#### Not available in these cases:

- “PHOTOfunSTUDIO” and “LoiLoScope” are not compatible with Mac.

# Monitor Display

## In recording

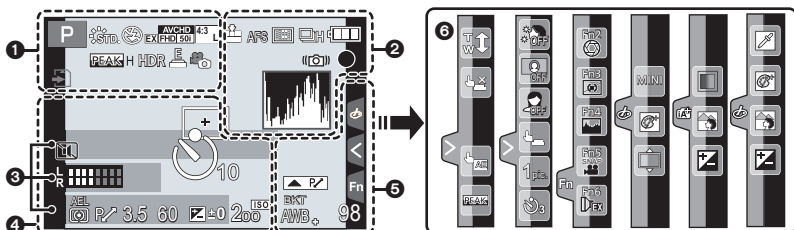

1

	Recording Mode (P18)
	Photo Style
	Flash Mode
	Flash
	Extra Tele Conversion (when recording motion pictures)
	Recording format/Recording quality
	Snap Movie (P27)
	Picture size/Aspect Ratio
	Extra Tele Conversion (when taking still pictures)
	Image effect (filter) adjustment display
	Image effect (filter) setting
	Card (displayed only during recording)
	Elapsed recording time*1 (P26)
	Simultaneous recording indicator
	Peaking
	HDR/iHDR (P22)
	Multi exposure
	Digital Zoom
	Electronic shutter

2

	Picture Mode (Still picture priorities)
	Overheat indicator (P39)
	Quality
	Focus Mode
	AF Mode
	Pull Focus (P27)
	Face Recognition
	AF Lock
	Burst
	Auto Bracket
	Self-timer
	Battery indication
	Optical Image Stabiliser*2
	Jitter alert
	Recording state (Flashes red.)
	Focus (Lights green.)
	Focus (Under low illumination)
	Connected to Wi-Fi
	Histogram

<b>3</b>	
Name <sup>*3</sup>	
Number of days that have passed since the departure date <sup>*4</sup>	
Age <sup>*3</sup>	
Location <sup>*4</sup>	
Current date and time/Travel destination setting <sup>*4</sup> :	
Exposure meter	
Focal distance display	
Step zoom	
<b>4</b>	
	AF area
+	Spot metering target
	Self-timer <sup>*5</sup>
	Mic level display
	Silent Mode
AEL	AE Lock
	Metering Mode
P	Programme Shift
3.5	Aperture value (P17)
60	Shutter speed (P17)
	Exposure compensation value
	Brightness (P22)
	Manual Exposure Assistance
	ISO sensitivity
<b>5</b>	
	Dial operation guide
BKT	White Balance Bracket
AWB	White Balance Fine Adjustment
	White Balance
	Colour (P22)

98	Number of recordable pictures <sup>*6</sup>
R8m30s	Available recording time <sup>*1, 6</sup>

**6**

## Touch tab

		Touch zoom
		Touch Shutter
		Touch AE
		Peaking
		In Self Shot Mode (P23)
		Function button (P18)
		Colour
		Defocus control function (P22)
		Brightness (P22)
		Type of defocus ([Miniature Effect])
		One point colour
		Position of the light source
		Image effect (filter) adjustment
		Image effect (filter)

\*1 h: hour, m: minute, s: second

\*2 Only available when a lens that supports the Stabiliser function is attached.

\*3 This is displayed for about 5 seconds when the camera is turned on if the [Profile Setup] setting is set.

\*4 This is displayed for about 5 seconds when the camera is turned on, after setting the clock and after switching from Playback Mode to Recording Mode.

\*5 This is displayed during countdown.

\*6 It is possible to switch the display between the number of recordable pictures and available recording time with the [Remaining Disp.] setting in the [Custom] menu.

# Menu list



## To display explanations of the menu items.

When [Menu Information] in the [Setup] menu is set to [ON], explanations of the menu items and settings are displayed on the menu screen.

Ⓐ Explanations of the menu



## [Rec]

This menu lets you set the aspect ratio, number of pixels and other aspects of the pictures you are recording.

[Photo Style]	[i.Resolution]	[ISO Increments]
[Filter Settings]	[i>Handheld Night Shot]	[Extended ISO]
[Aspect Ratio]	[i>HDR]	[Long Shtr NR]
[Picture Size]	[HDR]	[Shading Comp.]
[Quality]	[Multi Exp.]	[Ex. Tele Conv.]
[Sensitivity]	[Time Lapse Shot]	[Digital Zoom]
[Focus Mode]	[Stop Motion Animation]	[Color Space]
[Metering Mode]	[Panorama Direction]	[Stabilizer]
[Burst Rate]	[Shutter Type]	[Face Recog.]
[Auto Bracket]	[Flash]	[Profile Setup]
[Self Timer]	[Red-Eye Removal]	
[i.Dynamic]	[ISO Limit Set]	

## [Motion Picture]

This menu lets you set the [Rec Format], [Rec Quality], and other aspects for motion picture recording.

[Photo Style]	[Continuous AF]	[Mic Level Disp.]
[Filter Settings]	[Metering Mode]	[Mic Level Adj.]
[Snap Movie]	[i.Dynamic]	[Wind Cut]
[Rec Format]	[i.Resolution]	
[Rec Quality]	[Ex. Tele Conv.]	
[Focus Mode]	[Digital Zoom]	
[Picture Mode]	[Fikr Decrease]	

- [Photo Style], [Filter Settings], [Focus Mode], [Metering Mode], [i.Dynamic], [i.Resolution] and [Digital Zoom] are common to both the [Rec] menu and [Motion Picture] menu. Changing these settings in one of these menus is reflected in other menu.

**[Custom]**

Operation of the unit, such as displaying of the screen and button operations, can be set up according to your preferences.

[Silent Mode]	[Histogram]	[iA Button Switch]
[AF/AE Lock]	[Guide Line]	[Video Button]
[Half Press Release]	[Highlight]	[Power Zoom Lens]
[Quick AF]	[Zebra Pattern]	[Lens w/o Focus Ring]
[Pinpoint AF Time]	[Monochrome Live View]	[Self Shot]
[Pinpoint AF Display]	[Constant Preview]	[Touch Settings]
[AF Assist Lamp]	[Expo.Meter]	[Touch Scroll]
[Focus/Release Priority]	[Dial Guide]	[Menu Guide]
[AF+MF]	[Rec Area]	[Shoot w/o Lens]
[MF Assist]	[Remaining Disp.]	
[MF Assist Display]	[Auto Review]	
[MF Guide]	[Fn Button Set]	
[Peaking]	[Q.MENU]	

**[Setup]**

This menu lets you perform the clock settings, select the operating beep tone settings and set other settings which make it easier for you to operate the camera.

You can also configure the settings of Wi-Fi related functions.

[Clock Set]	[Economy]	[Exposure Comp. Reset]
[World Time]	[USB Mode]	[Self Timer Auto Off]
[Travel Date]	[TV Connection]	[No.Reset]
[Wi-Fi]	[Menu Resume]	[Reset]
[Beep]	[Menu Background]	[Reset Wi-Fi Settings]
[Live View Mode]	[Menu Information]	[Pixel Refresh]
[Monitor Display]	[Language]	[Sensor Cleaning]
[Monitor Luminance]	[Version Disp.]	[Format]

**[Playback]**

This menu lets you set the Protection, Cropping or Print Settings, etc. of recorded pictures.

[2D/3D Settings]	[Video Divide]	[Favorite]
[Slide Show]	[Time Lapse Video]	[Print Set]
[Playback Mode]	[Stop Motion Video]	[Protect]
[Location Logging]	[Resize]	[Face Rec Edit]
[Clear Retouch]	[Cropping]	[Picture Sort]
[Title Edit]	[Rotate]	[Delete Confirmation]
[Text Stamp]	[Rotate Disp.]	

# Troubleshooting

First, try out the following procedures.

**If the problem is not resolved, it may be improved by selecting [Reset] on the [Setup] menu.**

- Please also refer to the “Operating Instructions for advanced features (PDF format)”, which describes more detailed information.

**The camera cannot be operated even when it is turned on.  
The camera turns off immediately after it is turned on.**

- The battery is exhausted.  
→ Charge the battery.
- If you leave the camera on, the battery will be exhausted.  
→ Turn the camera off frequently by using the [Economy] etc.

**This unit suddenly turns off during recording.**

- When a high ambient temperature, continuous recording or other conditions cause the camera to overheat, the following restrictions will occur to protect the camera. Wait until the camera cools down.
  - Continuous recording, motion picture recording, and the Wi-Fi connection will be temporarily disabled.
  - If you continue recording even when [  ] is flashing on the screen, a message will be displayed and the camera will turn off automatically.

**The subject is not focused properly.**

- The subject is beyond the focus range of the camera.
- There is camera shake (jitter) or the subject is moving slightly.
- Is [Focus/Release Priority] in the [Custom] menu set to [RELEASE]?

**The recorded picture is blurred.  
The Optical Image Stabiliser is not effective.**

- The shutter speed will become slower and the Optical Image Stabiliser function may not work properly when taking pictures especially in dark places.
  - We recommend holding the camera firmly with both hands when taking pictures.
  - We recommend using a tripod and the self-timer when taking pictures with a slow shutter speed.
- When a moving subject is recorded with the electronic shutter, the subject may appear distorted on the picture.

**Striping or flicker may appear under lighting such as fluorescent lighting and LED lighting fixture.**

- This is characteristic of MOS sensors which serve as the camera's pickup sensors. This is not a malfunction.
- Are you taking pictures with the electronic shutter?
  - When using the electronic shutter, lowering the shutter speed may reduce the effect of the horizontal stripes.

**The brightness or the hue of the recorded picture is different from the actual scene.**

- When recording under fluorescent or LED lighting fixture, etc., increasing the shutter speed may introduce slight changes to brightness and colour. These are a result of the characteristics of the light source and do not indicate a malfunction.
- When recording subjects in extremely bright locations or recording under fluorescent lighting, LED lighting fixture, mercury lamp, sodium lighting, etc., the colours and screen brightness may change or horizontal striping may appear on the screen.

**The flash is not activated.**

- Is the flash closed?
  - Open the flash.
- When the electronic shutter is used, the flash is not activated.
  - Set [Shutter Type] to [AUTO] or [EFC].
- When [Silent Mode] is set to [ON], the flash is not activated.
  - Set [Silent Mode] to [OFF].

**The picture is not played back.  
There are no recorded pictures.**

- Is the card inserted? Is there a picture on the card?
- Is this a folder or picture which was processed in the PC?
  - If it is, it cannot be played back by this unit.
    - It is recommended to use the "PHOTOfunSTUDIO" software in the DVD (supplied) to write pictures from PC to card.
- Has [Playback Mode] been set for playback?
  - Change to [Normal Play].

**Motion pictures recorded with this model cannot be played back on other equipment.**

- The picture quality or sound quality of recorded motion pictures may be deteriorated even when these are played back with the compatible devices. Also, recording information may not be displayed correctly.



**A Wi-Fi connection cannot be established.  
Radio waves get disconnected.  
Wireless access point is not displayed.**

#### ■ General tips for using a Wi-Fi connection

- Use within the communication range of the device to be connected.
- Is any device, such as microwave oven, cordless phone, etc., that uses 2.4 GHz frequency operated nearby?
  - Radio waves may get interrupted when used simultaneously. Use them sufficiently away from the device.
- When the battery indicator is flashing red, the connection with other equipment may not start or the connection may be disrupted.  
(A message such as [Communication error] is displayed.)
- If you place the camera on a metal table or shelf, the radio waves may be adversely affected. In such cases, you may not be able to establish a connection. Move the camera away from the metal surface.

#### ■ About a wireless access point

- Check if the wireless access point to connect is in operating state.
- The camera may not display or connect to a wireless access point depending on the radio wave condition.
  - Move this unit closer to the wireless access point.
  - Remove the obstacles between this unit and the wireless access point.
  - Change the direction of this unit.
  - Change the location and orientation of the wireless access point.
  - Perform the [Manual Input].
- It may not display even if the radio waves exist depending on the setting of the wireless access point.
  - Check the settings of the wireless access point.
  - When the network SSID of the wireless access point is set not to broadcast, the wireless access point may not be detected. Enter the network SSID to start the connection or enable the SSID broadcast of the wireless access point.
- Connection types and security setting methods are different depending on the wireless access point. (Refer to the operating instructions of the wireless access point.)
- Is the 5 GHz/2.4 GHz switchable wireless access point connected to other equipment using the 5 GHz band?
  - The use of a wireless access point that can use 5 GHz/2.4 GHz simultaneously is recommended. It cannot be used simultaneously with this camera if it is not compatible.

### **Images cannot be transmitted to a PC.**

- When the firewall of the OS, security software, etc. is enabled, connecting to the PC may not be possible.

### **The PC is not recognised when I use a Wi-Fi connection. The camera cannot be connected to PC via Wi-Fi connection.**

- The default workgroup name is set to "WORKGROUP". If you changed the workgroup name, the PC will not be recognised.  
In [Change Workgroup Name] in [PC Connection] of the [Wi-Fi Setup] menu, change the workgroup name to that of the PC you are connecting to.
- When the system time of Mac computer or Windows PC connected to a camera differs severely from that of the camera, the camera cannot be connected to the Mac computer or Windows PC in some OSs.

### **When I try to set up a Wi-Fi connection with a Windows 8 PC, my user name and password are not recognised, so I cannot connect to the PC.**

- Some OS versions, including Windows 8, use two types of accounts: a local account and a Microsoft account.  
→ Be sure to use the user name and password for the local account.

### **Transmission of the image fails midway. Some images cannot be transmitted.**

- Image cannot be transmitted when the battery indicator is flashing red.
- Is the size of the image too large?  
→ Reduce the image size at [Size], and then send.  
→ Transmit after dividing the motion picture with [Video Divide].
- File format of the motion picture that can be sent differs depending on the destination.
- Capacity or number of images in the web service is full.  
→ Login to "LUMIX CLUB", and check the status of the destination on the web service link settings.

### **The shutter remains closed when the camera is turned off (including Sleep Mode).**

- If the camera is shaken, it may cause the shutter to close. This is not a malfunction. Do not put your finger in the mount. Turning on the camera will re-open the shutter.

### **There is a sound from lens unit.**

- It is a sound of lens movement or aperture operation when this unit is turned on or off, and it is not a malfunction.
- The sound, which is caused by the automatic adjustment of the aperture, is heard when the brightness has changed due to, for example, zooming or the movement of the camera. This is not a malfunction.

### **The camera becomes warm.**

- The surface of the camera and the reverse side of the monitor may become warm during use. This does not affect the performance or quality of the camera.

### **The clock is reset.**

- If you do not use the camera for a long time, the clock may be reset.  
→ [Please set the clock] message will be displayed; please reset the clock. (P16)

# Specifications

Specifications are subject to change without notice.

## Digital Camera Body (DMC-GF7):

Information for your safety

<b>Power Source:</b>	DC 8.4 V	
<b>Power Consumption:</b>	2.3 W (When recording) [When the Interchangeable lens (H-FS12032) is used] 2.2 W (When recording) [When the Interchangeable lens (H-FS35100) is used] 1.5 W (When playing back) [When the Interchangeable lens (H-FS12032) is used] 1.6 W (When playing back) [When the Interchangeable lens (H-FS35100) is used]	
<b>Camera effective pixels</b>	16,000,000 pixels	
<b>Image sensor</b>	4/3" Live MOS sensor, total pixel number 16,840,000 pixels, Primary colour filter	
<b>Digital Zoom</b>	Max. 4×	
<b>Extra Tele Conversion</b>	When taking still pictures: Max. 2× (When a picture size of [S] (4 M), aspect ratio of [4:3] is selected.) When recording motion pictures: 2.4×/3.6×/4.8×	
<b>Focus</b>	Auto Focus/Manual Focus, Face/Eye Detection/AF Tracking/23-area-focusing/1-area-focusing/Pinpoint (Touch focus area selection possible)	
<b>Shutter type</b>	Electronically-controlled, single curtain focal-plane shutter/ Electronic shutter	
<b>Burst recording</b>		
<b>Burst speed</b>	Mechanical shutter	5.8 pictures/second (High speed, AFS), 5 pictures/second (High speed, AFC), 4 pictures/second (Middle speed), 2 pictures/second (Low speed)
	Electronic shutter	40 pictures/second (Super high speed), 10 pictures/second (High speed), 4 pictures/second (Middle speed), 2 pictures/second (Low speed)

<b>Burst recording</b>	
<b>Number of recordable pictures</b>	Max. 7 pictures (when there are RAW files) Depends on the capacity of the card (when there are no RAW files)
<b>ISO sensitivity (Standard Output Sensitivity)</b>	AUTO/[ISO]/100*/200/400/800/1600/3200/6400/12800/25600 (1/3 EV step change possible) * Only available when [Extended ISO] is set.
<b>Minimum Illumination</b>	Approx. 9 lx (when i-Low light is used, the shutter speed is 1/25th of a second) [When the Interchangeable lens (H-FS12032) is used] Approx. 12 lx (when i-Low light is used, the shutter speed is 1/25th of a second) [When the Interchangeable lens (H-FS35100) is used]
<b>Shutter speed</b>	Still picture: T (Time) (Max. approx. 60 seconds), 60 seconds to 1/500th of a second (Mechanical shutter), 1 second to 1/16000th of a second (Electronic shutter) Motion picture: 1/25th of a second to 1/16000th of a second
<b>Metering range</b>	EV 0 to EV 18
<b>White Balance</b>	Auto White Balance/Daylight/Cloudy/Shade/Incandescent lights/Flash/White set1/White set2/White Balance K set
<b>Exposure (AE)</b>	Programme AE (P)/Aperture-priority AE (A)/Shutter-priority AE (S)/Manual exposure (M)/AUTO Exposure Compensation (1/3 EV Step, -5 EV to +5 EV)
<b>Metering Mode</b>	Multiple/Centre weighted/Spot
<b>Monitor</b>	3.0" TFT LCD (3:2) (Approx. 1,040,000 dots) (field of view ratio about 100%) Touch screen
<b>Flash</b>	Built-in pop up flash GN 5.6 equivalent (ISO200·m) [GN 4.0 equivalent (ISO100·m)] Flash range: Approx. 40 cm to 4.5 m [When the Interchangeable lens (H-FS12032) is mounted, WIDE, [ISO AUTO] is set] Flash range: Approx. 90 cm to 4.0 m [When the Interchangeable lens (H-FS35100) is mounted, WIDE, [ISO AUTO] is set] AUTO, AUTO/Red-Eye Reduction, Forced ON, Forced ON/ Red-Eye Reduction, Slow Sync., Slow Sync./Red-Eye Reduction, Forced OFF
<b>Flash synchronisation speed</b>	Equal to or smaller than 1/50th of a second (Mechanical shutter)

<b>Microphone</b>	Stereo	
<b>Speaker</b>	Monaural	
<b>Recording media</b>	SD Memory Card/SDHC Memory Card*/SDXC Memory Card* (* UHS-I-compatible)	
<b>Picture size</b>		
<b>Still picture</b>	When the aspect ratio setting is [4:3] 4592×3448 pixels, 3232×2424 pixels, 2272×1704 pixels When the aspect ratio setting is [3:2] 4592×3064 pixels, 3232×2160 pixels, 2272×1520 pixels When the aspect ratio setting is [16:9] 4592×2584 pixels, 3840×2160 pixels, 1920×1080 pixels When the aspect ratio setting is [1:1] 3424×3424 pixels, 2416×2416 pixels, 1712×1712 pixels	
<b>Recording quality</b>		
<b>Motion pictures</b>	[AVCHD] 1920×1080/50p (Sensor output is 50 frames/sec.) (28 Mbps)/ 1920×1080/50i (Sensor output is 50 frames/sec.) (17 Mbps)/ 1920×1080/50i (Sensor output is 25 frames/sec.) (24 Mbps)/ 1920×1080/24p (Sensor output is 24 frames/sec.) (24 Mbps) [MP4] 1920×1080/50p (Sensor output is 50 frames/sec.) (28 Mbps)/ 1920×1080/25p (Sensor output is 25 frames/sec.) (20 Mbps)/ 1280×720/25p (Sensor output is 25 frames/sec.) (10 Mbps)/ 640×480/25p (Sensor output is 25 frames/sec.) (4 Mbps)	
<b>Quality</b>	RAW/RAW+Fine/RAW+Standard/Fine/Standard/MPO+Fine/ MPO+Standard	
<b>Recording file format</b>		
<b>Still Picture</b>	RAW/JPEG (based on "Design rule for Camera File system", based on "Exif 2.3" standard, DPOF corresponding)/MPO	
<b>Motion pictures</b>	AVCHD Progressive/AVCHD/MP4	
<b>Audio compression</b>	AVCHD	Dolby® Digital (2 ch)
	MP4	AAC (2 ch)
<b>Interface</b>		
<b>Digital</b>	"USB 2.0" (High Speed)	
<b>Analogue video/audio</b>	NTSC/PAL Composite (Switched by menu) Audio line output (monaural)	
<b>Terminal</b>		
<b>[AV OUT/DIGITAL]</b>	Dedicated jack (8 pin)	
<b>[HDMI]</b>	microHDMI Type D	
<b>Dimensions</b>	Approx. 106.5 mm (W)×64.6 mm (H)×33.3 mm (D) (excluding the projecting parts)	

<b>Mass</b>	Approx. 266 g [with the card and battery] Approx. 236 g (camera body) Approx. 336 g [with the Interchangeable lens (H-FS12032), card and battery] Approx. 401 g [with the Interchangeable lens (H-FS35100), card and battery]
<b>Operating temperature</b>	0 °C to 40 °C
<b>Operating humidity</b>	10%RH to 80%RH

**Wireless transmitter**

<b>Compliance standard</b>	IEEE 802.11b/g/n (standard wireless LAN protocol)
<b>Frequency range used (central frequency)</b>	2412 MHz to 2462 MHz (1 to 11ch)
<b>Encryption method</b>	Wi-Fi compliant WPA™/WPA2™
<b>Access method</b>	Infrastructure mode

**Battery Charger (Panasonic DE-A98A):**

Information for your safety

<b>Input:</b>	AC ~ 110 V to 240 V, 50/60 Hz, 0.15 A
<b>Output:</b>	DC = 8.4 V, 0.43 A

**Battery Pack (lithium-ion) (Panasonic DMW-BLH7E):**

Information for your safety

<b>Voltage/capacity:</b>	7.2 V/680 mAh
--------------------------	---------------

Interchangeable Lens	H-FS12032 “LUMIX G VARIO 12–32 mm/ F3.5–5.6 ASPH./MEGA O.I.S.”	H-FS35100 “LUMIX G VARIO 35–100 mm/ F4.0–5.6 ASPH./MEGA O.I.S.”
<b>Focal length</b>	f=12 mm to 32 mm (35 mm film camera equivalent: 24 mm to 64 mm)	f=35 mm to 100 mm (35 mm film camera equivalent: 70 mm to 200 mm)
<b>Aperture type</b>	7 diaphragm blades/circular aperture diaphragm	7 diaphragm blades/circular aperture diaphragm
<b>Aperture range</b>	F3.5 (Wide) to F5.6 (Tele)	F4.0 (Wide) to F5.6 (Tele)
<b>Minimum aperture value</b>	F22	F22
<b>Lens construction</b>	8 elements in 7 groups (3 aspherical lenses, 1 ED lens)	12 elements in 9 groups (1 aspherical lens, 2 ED lenses)
<b>In focus distance</b>	0.2 m to $\infty$ (from the focus distance reference line) (focal length 12 mm to 20 mm), 0.3 m to $\infty$ (from the focus distance reference line) (focal length 21 mm to 32 mm)	0.9 m to $\infty$ (from the focus distance reference line)
<b>Maximum image magnification</b>	0.13 $\times$ (35 mm film camera equivalent: 0.26 $\times$ )	0.11 $\times$ (35 mm film camera equivalent: 0.22 $\times$ )
<b>Optical Image Stabiliser</b>	Available	Available
<b>[O.I.S.] switch</b>	None (Setting of the [Stabilizer] is done in [Rec] menu.)	None (Setting of the [Stabilizer] is done in [Rec] menu.)
<b>Mount</b>	“Micro Four Thirds Mount”	“Micro Four Thirds Mount”
<b>Angle of view</b>	84° (Wide) to 37° (Tele)	34° (Wide) to 12° (Tele)
<b>Filter diameter</b>	37 mm	46 mm
<b>Max. diameter</b>	Approx. 55.5 mm	Approx. 55.5 mm
<b>Overall length</b>	Approx. 24 mm (from the tip of the lens to the base side of the lens mount when the lens barrel is recessed)	Approx. 50 mm (from the tip of the lens to the base side of the lens mount when the lens barrel is recessed)
<b>Mass</b>	Approx. 70 g	Approx. 135 g

# Digital Camera Accessory System

Description	Accessory#
Battery Pack	DMW-BLH7
AC Adaptor* <sup>1</sup>	DMW-AC10
DC Coupler* <sup>1</sup>	DMW-DCC15
Body Cap	DMW-BDC1
Tripod Adaptor* <sup>2</sup>	DMW-TA1
USB connection Cable	DMW-USBC1
AV Cable	DMW-AVC1
Mount Adaptor	DMW-MA1, DMW-MA2M, DMW-MA3R

\*1 The AC Adaptor (optional) can only be used with the designated Panasonic DC Coupler (optional). The AC adaptor (optional) cannot be used by itself.

\*2 Use if the attached lens is in contact with the tripod pedestal.

Product numbers correct as of January 2015. These may be subject to change.

- Some optional accessories may not be available in some countries.
- NOTE: Accessories and/or model numbers may vary between countries. Consult your local dealer.
- For lens-related optional accessories such as compatible lenses and filters, refer to catalogues/ Web pages, etc.



# Reading the Operating Instructions (PDF format)

More detailed instructions on the operation of this camera are contained in “Operating Instructions for advanced features (PDF format)” in the supplied DVD.

## ■ For Windows

- 1 Turn the PC on and insert the DVD containing the Operating Instructions (supplied).**
  - If the automatic playback screen is displayed, you can display the menu by selecting and executing [Launcher.exe].
  - In Windows 8/Windows 8.1, you can display the menu by clicking a message that is displayed after inserting the DVD and then selecting and executing [Launcher.exe].
  - You can also display the menu by double-clicking [SFMXXXX] in [Computer] (XXXX differs depending on the model).
- 2 Click the [Operating Instructions].**
  - The list of Operating Instructions (PDF format) will be displayed.
- 3 Click the language of the Operating Instructions you want to open.**
  - The “Operating Instructions for advanced features (PDF format)” will open.  
You can save the “Operating Instructions for advanced features” on the PC.

• You will need Adobe Reader to browse or print the “Operating Instructions for advanced features (PDF format)”.

You can download and install a version of Adobe Reader that you can use with your OS from the following website. (As of January 2015)

<http://www.adobe.com/products/acrobat/readstep2.html>

## ■ For Mac

- 1 Turn the PC on and insert the DVD containing the Operating Instructions (supplied).**
- 2 Open the “Manual” folder in the DVD.**
- 3 Double click the [INDEX.pdf].**
  - The list of Operating Instructions (PDF format) will be displayed.
- 4 Click the language of the Operating Instructions you want to open.**
  - The “Operating Instructions for advanced features (PDF format)” will open.  
You can save the “Operating Instructions for advanced features” on the PC.

# Limited Warranty (ONLY FOR AUSTRALIA)

## Panasonic Warranty

- The product is warranted for 12 months from the date of purchase. Subject to the conditions of this warranty Panasonic or its Authorised Service Centre will perform necessary service on the product without charge for parts or labour, if in the opinion of Panasonic, the product is found to be faulty within the warranty period.
- This warranty only applies to Panasonic products purchased in Australia and sold by Panasonic Australia or its Authorised Distributors or Dealers and only where the products are used and serviced within Australia or its territories. Warranty cover only applies to service carried out by a Panasonic Authorised Service Centre and only if valid proof of purchase is presented when warranty service is requested.
- This warranty only applies if the product has been installed and used in accordance with the manufacturer's recommendations (as noted in the operating instructions) under normal use and reasonable care (in the opinion of Panasonic). The warranty covers normal domestic use only and does not cover damage, malfunction or failure resulting from use of incorrect voltages, incorrect installation, accident, misuse, neglect, build-up of dirt or dust, abuse, maladjustment of customer controls, mains supply problems, thunderstorm activity, infestation by insects or vermin, tampering or repair by unauthorised persons (including unauthorised alterations), introduction of sand, humidity or liquids, commercial use such as hotel, office, restaurant, or other business or rental use of the product, exposure to abnormally corrosive conditions or any foreign object or matter having entered the product.
- This warranty does not cover the following items unless the fault or defect existed at the time of purchase:
 

(a) Cabinet Part(s)	(e) DVD, Blu-ray or Recordable Discs
(b) Video or Audio Tapes	(f) Video / Audio Heads from wear and tear in normal use
(c) SD cards or USB devices	(g) Information stored on Hard Disk Drive, USB stick or SD card
(d) User replaceable Batteries etc	(h) DTV reception issues caused by TV Aerial / Cabling / Wall socket(s)
- Some products may be supplied with Ethernet connection hardware. The warranty is limited on such products and will not cover:
  - Internet and or DLNA connection / setup related problems
  - Access fees and or charges incurred for internet connection
  - The use of incompatible software or software not specifically stipulated in the product operations manual; and
  - Any indirect or consequential costs associated with the incorrect use or misuse of the hardware, its connection to the internet or any other device.
- To claim warranty service, when required, you should:
  - Telephone Panasonic's Customer Care Centre on 132600 or visit our website referred to below and use the Service Centre Locator for the name/address of the nearest Authorised Service Centre.
  - Send or take the product to a Panasonic Authorised Service Centre together with your proof of purchase receipt as a proof of purchase date. Please note that freight and insurance to and / or from your nearest Authorised Service Centre must be arranged by you.
  - Note that home or pick-up/delivery service is available for the following products in the major metropolitan areas of Australia or the normal operating areas of the nearest Authorised Service Centres:
    - Plasma/LCD televisions / displays (screen size greater than 103 cm)
- The warranties hereby conferred do not extend to, and exclude, any costs associated with the installation, de-installation or re-installation of a product, including costs related to the mounting, de-mounting or remounting of any screen, (and any other ancillary activities), delivery, handling, freight, transportation or insurance of the product or any part thereof or replacement of and do not extend to, and exclude, any damage or loss occurring by reason of, during, associated with, or related to such installation, de-installation, re-installation or transit.

Panasonic Authorised Service Centres are located in major metropolitan areas and most regional centres of Australia, however, coverage will vary dependant on product. For advice on exact Authorised Service Centre locations for your product, please telephone our Customer Care Centre on 132600 or visit our website and use the Service Centre Locator.

In addition to your rights under this warranty, Panasonic products come with consumer guarantees that cannot be excluded under the Australian Consumer Law. If there is a major failure with the product, you can reject the product and elect to have a refund or to have the product replaced or if you wish you may elect to keep the goods and be compensated for the drop in value of the goods. You are also entitled to have the product repaired or replaced if the product fails to be of acceptable quality and the failure does not amount to a major failure.

If there is a major failure in regard to the product which cannot be remedied then you must notify us within a reasonable period by contacting the Panasonic Customer Care Centre. If the failure in the product is not a major failure then Panasonic may choose to repair or replace the product and will do so in a reasonable period of time from receiving notice from you.

**THIS WARRANTY CARD AND THE PURCHASE DOCKET (OR SIMILAR PROOF OF PURCHASE) SHOULD BE RETAINED BY THE CUSTOMER AT ALL TIMES**

If you require assistance regarding warranty conditions or any other enquiries, please visit the **Panasonic Australia** website [www.panasonic.com.au](http://www.panasonic.com.au) or contact by phone on **132 600** *If phoning in, please ensure you have your operating instructions available.*

**Panasonic Australia Pty. Limited**

ACN 001 592 187 ABN 83 001 592 187  
1 Innovation Road, Macquarie Park NSW 2113

PRO-031-F11 Issue: 4.0

01-01-2011

This product incorporates the following software:

- (1) the software developed independently by or for Panasonic Corporation,
- (2) the software owned by third party and licensed to Panasonic Corporation, and/or
- (3) open source software

The software categorised as (3) is distributed in the hope that it will be useful, but WITHOUT ANY WARRANTY, without even the implied warranty of MERCHANTABILITY or FITNESS FOR A PARTICULAR PURPOSE.

Please refer to the detailed terms and conditions thereof displayed by selecting [MENU/SET] → [Setup] → [Version Disp.] → [Software info].

- G MICRO SYSTEM is a lens exchange type digital camera system of LUMIX based on a Micro Four Thirds System standard.
- Micro Four Thirds™ and Micro Four Thirds Logo marks are trademarks or registered trademarks of Olympus Imaging Corporation, in Japan, the United States, the European Union and other countries.
- Four Thirds™ and Four Thirds Logo marks are trademarks or registered trademarks of Olympus Imaging Corporation, in Japan, the United States, the European Union and other countries.
- SDXC Logo is a trademark of SD-3C, LLC.
- “AVCHD”, “AVCHD Progressive” and the “AVCHD Progressive” logo are trademarks of Panasonic Corporation and Sony Corporation.
- Manufactured under license from Dolby Laboratories. Dolby and the double-D symbol are trademarks of Dolby Laboratories.
- HDMI, the HDMI Logo, and High-Definition Multimedia Interface are trademarks or registered trademarks of HDMI Licensing LLC in the United States and other countries.
- HDAVI Control™ is a trademark of Panasonic Corporation.
- Adobe is a trademark or registered trademark of Adobe Systems Incorporated in the United States and/or other countries.
- Pentium is a trademark of Intel Corporation in the U.S. and/or other countries.
- iMovie, Mac and Mac OS are trademarks of Apple Inc., registered in the U.S. and other countries.
- iPad, iPhone, iPod, and iPod touch are trademarks of Apple Inc., registered in the U.S. and other countries.
- App Store is a service mark of Apple Inc.
- Windows and Windows Vista are either registered trademarks or trademarks of Microsoft Corporation in the United States and/or other countries.



- QuickTime and the QuickTime logo are trademarks or registered trademarks of Apple Inc., used under license therefrom.
- Android and Google Play are trademarks or registered trademarks of Google Inc.
- The Wi-Fi CERTIFIED™ Logo is a certification mark of Wi-Fi Alliance®.
- The Wi-Fi Protected Setup™ Identifier mark is a certification mark of Wi-Fi Alliance®.
- “Wi-Fi®” and “Wi-Fi Direct®” are registered trademarks of Wi-Fi Alliance®.
- “Wi-Fi Protected Setup™”, “WPA™”, and “WPA2™” are trademarks of Wi-Fi Alliance®.
- DLNA, the DLNA Logo and DLNA CERTIFIED are trademarks, service marks, or certification marks of the Digital Living Network Alliance.
- This product uses “DynaFont” from DynaComware Corporation. DynaFont is a registered trademark of DynaComware Taiwan Inc.
- QR Code is a registered trademark of DENSO WAVE INCORPORATED.
- Other names of systems and products mentioned in these instructions are usually the registered trademarks or trademarks of the manufacturers who developed the system or product concerned.



This product is licensed under the AVC patent portfolio license for the personal and non-commercial use of a consumer to (i) encode video in compliance with the AVC Standard (“AVC Video”) and/or (ii) decode AVC Video that was encoded by a consumer engaged in a personal and non-commercial activity and/or was obtained from a video provider licensed to provide AVC Video. No license is granted or shall be implied for any other use. Additional information may be obtained from MPEG LA, LLC. See <http://www.mpegla.com> .