

Panasonic®

Operating Instructions for advanced features

Digital Camera

Model No. **DMC-FP3**

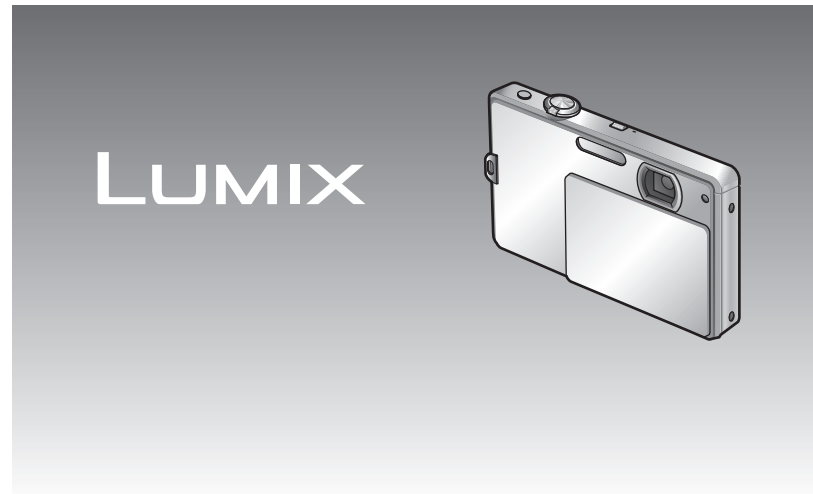

Before use, please read these instructions completely.



Quick start guide

The battery is not charged when the camera is shipped. Charge the battery and set the clock before use.

When you do not use the card (optional), you can record or play back pictures on the built-in memory (→12).

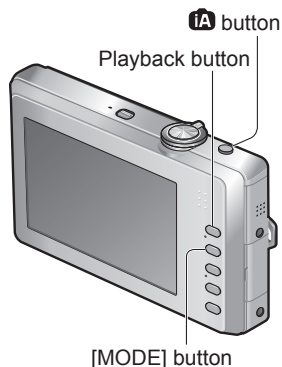
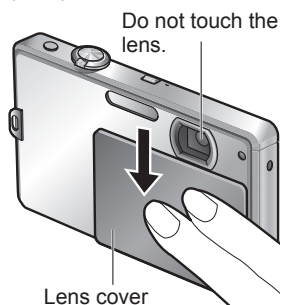

1 Charge the battery

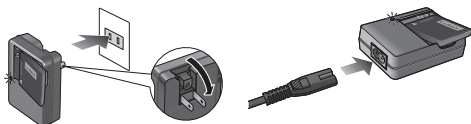

2 Insert the battery and the card

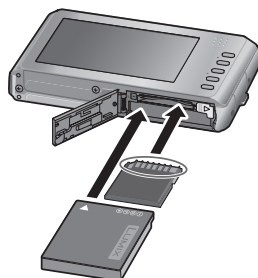

3 Open the lens cover

4 Select the desired Recording Mode

■ To use settings automatically selected by the camera

- 1 Press the **iA** button.

■ To select the Recording Mode manually

- 1 Press the [MODE] button.
- 2 Touch the desired Recording Mode.

5 Press the shutter button and take pictures

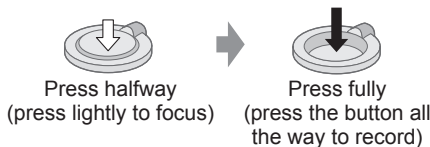

■ To play back the pictures

- 1 Press the Playback button.
- 2 Select the picture you want to view.
 - You can also go to the next or previous picture by dragging the center of the screen. (→32)

Contents

Before use

Before use	5
Read first	5
To prevent damage, malfunctions, and faults	5
Standard Accessories	6
Names of parts	7
Using the Touch Panel	8
Touch operations	8

Preparations

Charging the battery	9
Guidelines for number of recordable pictures and recording time	10
Inserting and removing the card (optional)/the battery	11
Picture save destination (cards and built-in memory)	12
Remaining battery and memory capacity	12
Setting the clock	13
To change time setting	14
Setting the menu	15
Menu type	16
Using Quick menu	17
Using the [SETUP] menu	18
[CLOCK SET]/[WORLD TIME]/	
[TRAVEL DATE]/[BEEP]/	
[VOLUME]	18
[LCD MODE]/[FOCUS ICON]	19
[AUTO POWER OFF]/	
[AUTO REVIEW]	20
[RESET]/[USB]/[USB MODE]	21
[VIDEO OUT]/[TV ASPECT]/	
[VERSION DISP.]/[FORMAT]	22
[LANGUAGE]/[DEMO] [DEMO MODE]	23

Basics

Sequence of Recording	24
Convenient ways to turn the power on	25
Taking pictures with automatic settings [INTELLIGENT AUTO] Mode	26
Taking pictures with your own settings [NORMAL PICTURE] Mode	28
Align focus for desired composition	29
Direction detection function	29
Taking pictures with zoom	30
Enlarging further [DIGITAL ZOOM]	31
Viewing your pictures [NORMAL PLAY]	32
Deleting pictures	33
To delete multiple (up to 50) or all pictures	33

Contents (Continued)

Application (Record)

Changing recording information display ...	34
Taking pictures with the self-timer	35
Taking pictures with flash.....	36
Taking close-up pictures	38
Taking pictures at even closer range	
[M [MACRO ZOOM].....	39
Taking pictures with the Touched Area in Focus (Touch AF Area Selection)	40
Taking pictures with exposure compensation	41
SCN Taking pictures according to the scene [SCENE MODE]	42
[PORTRAIT]/[SOFT SKIN]/	
[TTRANSFORM].....	43
[SELF PORTRAIT]/[SCENERY]/	
[SPORTS]/[NIGHT PORTRAIT]	44
[NIGHT SCENERY]/[FOOD]/	
[PARTY]/[CANDLE LIGHT].....	45
[BABY]/[PET]/[SUNSET].....	46
[HIGH SENS.]/[HI-SPEED BURST]..	47
[FLASH BURST]/[STARRY SKY]..	48
[FIREWORKS]/[BEACH]/[SNOW]/	
[AERIAL PHOTO]/[FILM GRAIN]/	
[PHOTO FRAME]	49
MS Registering commonly used scenes [MY SCENE MODE].....	50
Taking motion pictures [MOTION PICTURE] Mode.....	51
[REC QUALITY].....	52
Useful features for travel.....	53
[TRAVEL DATE].....	53
[WORLD TIME].....	54
Using the [REC] menu.....	56
[FLASH]/[SELF TIMER]/	
[PICTURE SIZE].....	56
[ISO] [SENSITIVITY]	57
[AF MODE]	58
[MACRO MODE]/[WB] [WHITE BALANCE] ...	59
[EXPOSURE]/[BURST]/	
[DIGITAL ZOOM]	60
[COLOR MODE]/[STABILIZER]	61
AF* [AF ASSIST LAMP]/	
[RED-EYE REMOVAL]/[CLOCK SET] ...	62
Entering Text.....	63

Application (View)

Viewing as list (Multi Playback/Calendar Playback) ...	64
Watching motion pictures	65
Different playback methods (Playback Mode)	66
[SLIDE SHOW]	67
[CATEGORY PLAY]/	
★ [FAVORITE PLAY]	69
Using the [PLAYBACK] menu	70
[TEXT STAMP]	70
[RESIZE].....	71
[>] [CROPPING].....	73
[ROTATE DISP.]/★ [FAVORITE].....	74
[PRINT SET]	75
[PROTECT].....	76
[COPY].....	77

Connecting with other devices

Using with your PC.....	78
Printing	80
Printing multiple pictures	81
Print with date and text.....	81
Making print settings on camera	82
Viewing on TV screen	83

? Others

List of LCD monitor displays.....	84
In recording	84
In playback	85
Message displays	86
Q&A Troubleshooting	88
Usage cautions and notes	94
Recording picture/time capacity	96

Before use

Read first

- Fully peel off the strip of tape from the lens cover before using the camera.

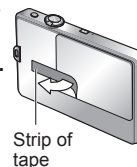

- Do a test shot first!

Check first to see if you can take pictures and record sounds successfully.

- We will not compensate for failed/lost recording or for direct/indirect damage.

Panasonic will not provide compensation even if damage is caused by faults with camera or card.

- Certain pictures cannot be played back.

- Pictures edited on a computer.
- Pictures taken or edited on a different camera.
(Pictures taken or edited on this camera may also not be able to be played back on other cameras.)

- Software on the CD-ROM supplied

The following actions are prohibited:

- Making duplicates (copying) for sale or rent.
- Copying onto networks.

To prevent damage, malfunctions, and faults

- Avoid shocks, vibration, and pressure.

- Avoid exposing the camera to strong vibration or shock; e.g. dropping or hitting the camera, or sitting down with the camera in your pocket.
(Attach hand strap to avoid dropping camera. Hanging any items other than the supplied hand strap from the camera can apply pressure against it.)
- Do not press the lens or the LCD monitor.

- Do not get the camera wet or insert foreign objects.
This camera is not waterproof.

- Do not expose the camera to water, rain, or seawater.
(If camera gets wet, wipe with a soft, dry cloth. Wring cloth thoroughly first if wet with seawater, etc.)
- Avoid exposing lens and socket to dust or sand, and do not allow liquids to leak into gaps around buttons.
- When opening and closing the lens cover, make sure that liquid or foreign objects such as sand do not enter.
- Avoid condensation caused by sudden changes in temperature and humidity.
- When moving between places of different temperature or humidity, place camera into a plastic bag and allow to adjust to conditions before use.
- If the lens clouds up, switch off the power and leave for about two hours to allow camera to adjust to conditions.
- If the LCD monitor clouds up, wipe with a soft, dry cloth.

LCD monitor characteristics

Extremely high precision technology is employed to produce the LCD monitor screen. However there may be some dark or bright spots (red, blue or green) on the screen. This is not a malfunction.

The LCD monitor screen has more than 99.99% effective pixels with a mere 0.01% of the pixels inactive or always lit. The spots will not be recorded on pictures on the built-in memory or a card.

Before use (Continued)

To prevent damage, malfunctions, and faults

■ Lens

- Do not leave the lens exposed to direct sunlight.

■ When using a tripod or unipod

- Do not apply excessive force or tighten screws when they are crooked. (This may damage the camera, screw hole, or label.)
- Ensure that the tripod is stable. (Refer to the tripod instructions.)

■ When transporting

Switch off power.

(To prevent the camera from being turned on accidentally, make sure not to open the lens cover when putting the camera away or removing it from the case.)

Please also refer to 'Usage cautions and notes' (→94).

The following do not indicate mechanical problems.

- The camera rattles when shaken. (This is the sound of the lens moving.)
- The camera clicks when turned on or off, or when switched between recording and playback. (This is also the sound of the lens moving.)
- You feel vibration when zooming in or out. (This is from the lens moving.)
- The lens makes a noise when you are recording. (This is the sound of iris adjustment in response to changes in ambient light.) At this time, pictures displayed on the LCD monitor change rapidly, but the recording is not affected.

Standard Accessories

Check that all the accessories are included before using the camera.

- The accessories and their shape will differ depending on the country or area where the camera was purchased. For details on the accessories, refer to Basic Operating Instructions.
- Battery Pack is indicated as battery pack or battery in the text.
- Battery Charger is indicated as battery charger or charger in the text.
- Please dispose of all packaging appropriately.

■ Optional accessories

- Cards are optional. You can record or play back pictures on the built-in memory when you are not using a card.
- Consult the dealer or your nearest Service Centre if you lose the supplied accessories. (You can purchase the accessories separately.)

Names of parts

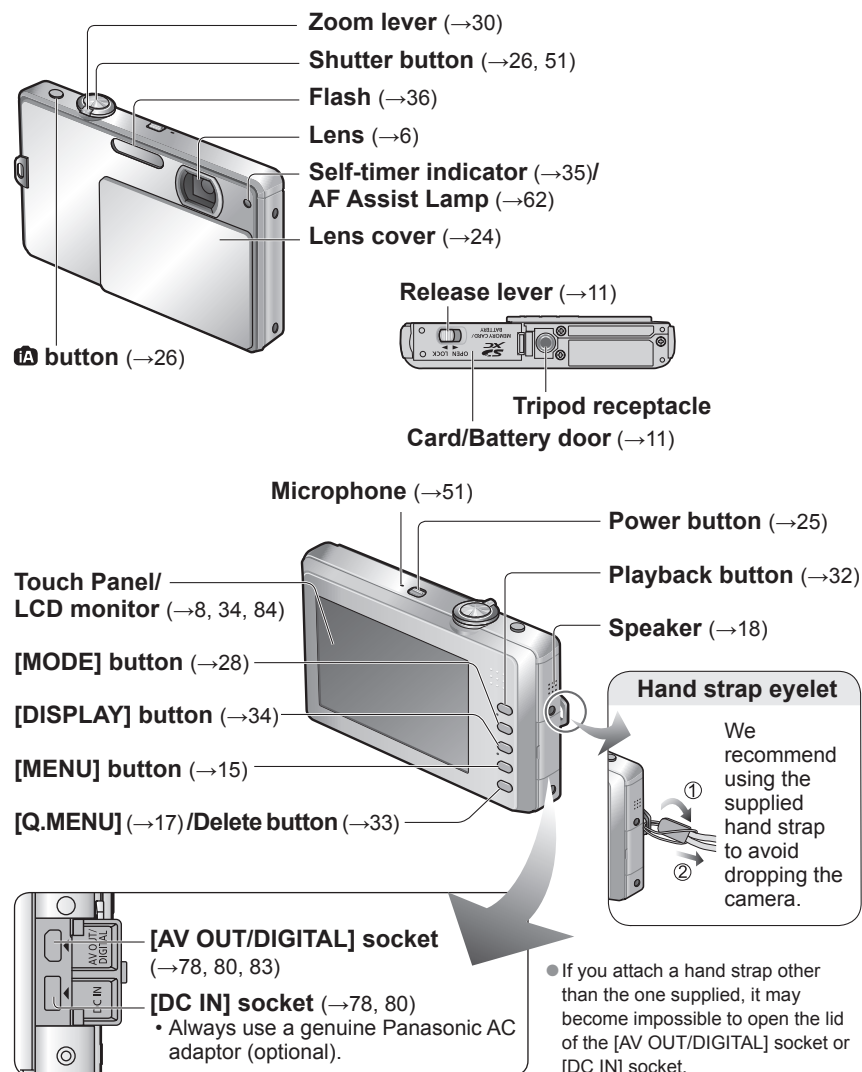

• The illustrations and screens in this manual may differ from the actual product.

Using the Touch Panel

This camera's LCD monitor is a touch panel. Touch or drag your finger on the screen to record, play back and make settings.

- This touch panel detects the electrical properties of the human body (capacitive touch panel). Touch the panel directly with your bare finger.
- Touch the panel with a clean and dry finger.
- The touch panel generally cannot be used;
 - With a commercially available stylus pen or a gloved hand
 - With wet hands or immediately after applying hand lotion
 - When you use a commercially available liquid crystal protection sheet (it may impair visibility and operability.)
 - When both hands or more than one finger are on the touch panel at the same time
- Do not press on the LCD monitor with hard pointed tips, such as ball point pens.
- Do not operate with your fingernails.
- Wipe the LCD monitor with a dry soft cloth when it gets dirty.
- Do not scratch or press the LCD monitor too hard.

Touch operations

■ Touch

To "touch" is to press the touch panel and then pull the finger back again.

Touching is used to select icons or pictures, among other actions.

- Touch an icon near its centre. If multiple icons are touched simultaneously, the camera may not operate normally.
- Touch and release ▲▼◀▶ icons repeatedly until the required value/setting is obtained. The value/setting does not change in succession when you keep touching the icons.

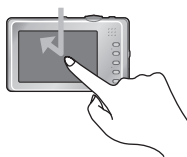

■ Drag

To "drag" is to touch and slide your finger across the touch panel surface.

During playback, if you drag your finger from the centre of the screen to the left or right, the display advances or goes back to another picture.

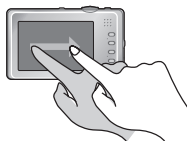

■ Effective range of touching

Touch operations do not work at the edge of the screen.



Detection area of the sensor (approximation)

- During touch operations, hold the camera securely so it does not drop.
- If a screen icon, etc. does not respond when touched, change the position that you are touching slightly and try the operation again.

Charging the battery

Always charge before first use! (not sold pre-charged)

■ About batteries that you can use with this unit

It has been found that counterfeit battery packs which look very similar to the genuine product are made available to purchase in some markets. Some of these battery packs are not adequately protected with internal protection to meet the requirements of appropriate safety standards. There is a possibility that these battery packs may lead to fire or explosion. Please be advised that we are not liable for any accident or failure occurring as a result of use of a counterfeit battery pack. To ensure that safe products are used we recommend that a genuine Panasonic battery pack is used.

- Use the dedicated charger and battery.
- The camera has a function for distinguishing batteries which can be used safely. The dedicated battery supports this function. The only batteries suitable for use with this unit are genuine Panasonic products and batteries manufactured by other companies certified by Panasonic. (Batteries which do not support this function cannot be used). Panasonic cannot in any way guarantee the quality, performance or safety of batteries which have been manufactured by other companies and are not genuine Panasonic products.

1 Insert the battery terminals and attach the battery to the charger

Ensure [LUMIX] faces outwards.

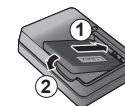

2 Connect the charger to the electrical outlet

- Plug-in type
Battery (model-specific)

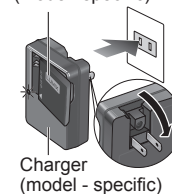

- Inlet type

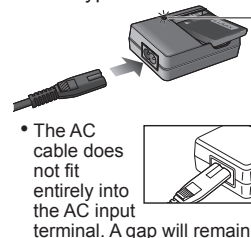

Charging light ([CHARGE])

On: Charging in progress (approx. 110 min. if fully depleted)

Off: Charging complete

If light is flashing:

- Charging may take longer than normal if battery temperature is too high or too low (charging may not be completed).
- Battery/charger connector is dirty. Clean with a dry cloth.

3 Detach the battery after charging is completed

Charging the battery (Continued)

Guidelines for number of recordable pictures and recording time

Figures may be reduced if flash, zoom, or [LCD MODE] are used frequently; or in colder climates.

Number of recordable pictures	Approx. 300 pictures	By CIPA standard
Recording time	Approx. 150 min	

Recording conditions by CIPA standard

- CIPA is an abbreviation of [Camera & Imaging Products Association].
- [NORMAL PICTURE] Mode.
- Temperature: 23 °C/Humidity: 50% when LCD monitor is on.*
- Using a Panasonic SD Memory Card (32 MB).
- Using the supplied battery.
- Starting recording 30 seconds after the camera is turned on. (When the Optical Image Stabilizer function is set to [AUTO].)
- Recording once every 30 seconds with full flash every second recording.
- Rotating the zoom lever from Tele to Wide or vice versa in every recording.
- Turning the camera off every 10 recordings and leaving it until the temperature of the battery decreases.

* The number of recordable pictures decreases in Auto Power LCD Mode and Power LCD Mode.

Number reduced if intervals longer – e.g. to approx. one quarter (75 pictures) for 2-minute intervals under the above conditions.

Playback time	Approx. 260 min
---------------	-----------------

The number of recordable pictures or available recording time may vary slightly according to battery and usage conditions.

- The time required for charging varies depending on conditions of battery usage. Charging takes longer at high or low temperatures and when the battery has not been used in some time.
- Battery will be warm during charging and for some time thereafter.
- Battery will run out if not used for long periods of time, even after being charged.
- Charge the battery with the charger indoors (10 °C - 35 °C).
- Do not leave any metal items (such as clips) near the contact areas of the power plug. Otherwise, a fire and/or electric shocks may be caused by short-circuiting or resulting heat generated.
- Frequently charging battery is not recommended. (Frequently charging battery reduces maximum usage time and can cause battery to expand.)
- Do not disassemble or modify the charger.
- If available battery power is significantly reduced, battery is reaching end of lifespan. Please purchase a new battery.
- The battery charger is in the standby condition when the AC power is supplied. The primary circuit is always "live" as long as the battery charger is connected to an electrical outlet.
- When charging:
 - Remove any dirt on connectors of charger and battery with dry cloth.
 - Keep at least 1 m (3.28 feet) away from AM radio (may cause radio interference).
 - Noises may be emitted from inside of charger, but this is not a fault.
 - Remove charger from wall socket after charging (up to 0.1 W consumed if left in place).
- Do not use a damaged or dented battery (especially connectors), e.g. by dropping (can cause faults).

Inserting and removing the card (optional)/the battery

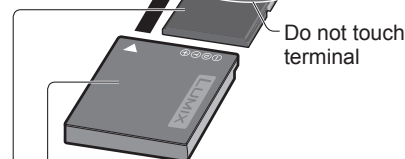
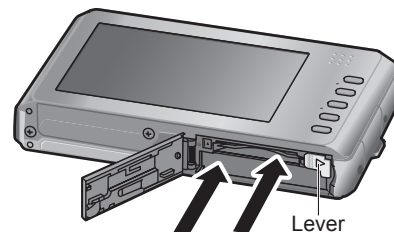

Charged battery (check orientation)
Card (check orientation: terminals face LCD)

- 1 Turn the camera off and slide the release lever to [OPEN] before opening the lid

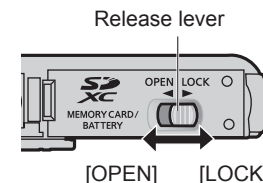

- 2 Completely insert battery and card

- Battery: Insert until the lever locks into place.
- Card: Insert until it clicks.

- 3 Close lid

Slide to the [LOCK] position.

To remove

To remove battery:

move lever in direction of arrow.

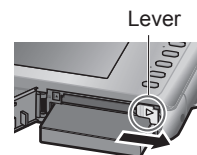

To remove card:

press down in centre.

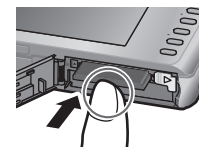

- Always use genuine Panasonic batteries.
- If you use other batteries, we cannot guarantee the quality of this product.
- Remove battery from camera after use.
 - Store the battery in battery carrying case (supplied).
- To remove the card or battery, turn the camera off and wait until the LCD monitor display is completely blank. (Failure to wait may cause the camera to malfunction and may damage the card or recorded data.)
- Keep the Memory Card out of reach of children to prevent swallowing.

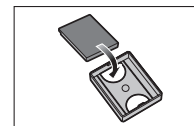

Inserting and removing the card (optional)/ the battery (Continued)

Picture save destination (cards and built-in memory)

Pictures will be saved to a card if one is inserted, or to the built-in memory  if not.

■ Built-in memory (approx. 40 MB)

- Pictures may be copied between cards and the built-in memory (→77).
- The access time for the built-in memory may be longer than the access time for a card.
- [QVGA] in [REC QUALITY] only can be available to record motion pictures in the built-in memory.

■ Compatible memory cards (optional)

The following SD standard-based cards (Panasonic brand recommended)

Type of Card	Capacity	Notes
SD memory cards	8 MB – 2 GB	<ul style="list-style-type: none"> • Can be used with devices compatible with the respective formats. • Before using SDXC memory cards, check that your computer and other devices support this type of card. http://panasonic.net/avc/sdcard/information/SDXC.html • Cards in capacities not listed at left are not supported.
SDHC memory cards	4 GB – 32 GB	
SDXC memory cards	48 GB – 64 GB	



- Please reformat the card with this camera if it has already been formatted with a computer or another device. (→22)
- If the write-protect switch is set to 'LOCK', the card cannot be used to record or delete pictures, and it cannot be formatted.
- It is recommended that you copy important pictures to your computer (as electromagnetic waves, static electricity, or faults may cause data to be damaged).
- Latest information:
<http://panasonic.jp/support/global/cs/dsc/> (This Site is English only.)

Remaining battery and memory capacity



Remaining battery (only when using battery)



If the battery mark flashes red, recharge or replace battery. (→9)

Displayed when no card inserted (pictures will be saved to built-in memory)

Pictures remaining (→96)

When in operation

 (Card) or  (Built-in memory) are illuminated red.

This means that an operation is in progress, such as the recording, reading, deleting, or formatting of pictures. Do not turn off the power or remove the battery, card, or AC adaptor (optional) (this may cause damage to or loss of data).

Do not subject the camera to vibrations, impact, or static electricity. Should any of these cause camera operation to be terminated, attempt to perform the operation again.

Setting the clock

The clock is not set when the camera is shipped.

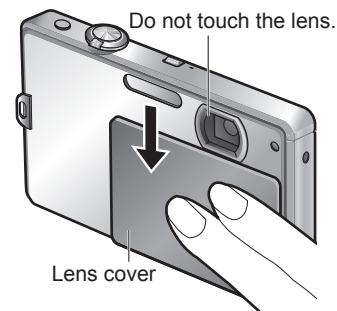

Setting the date and time

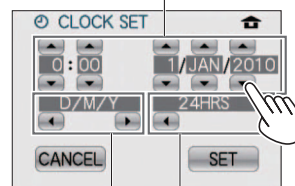

Setting the date display format

Setting the time display format

1 Open the lens cover

- The power is turned on.
If [PLEASE SET THE LANGUAGE] is displayed
→ go to step 2
- If [PLEASE SET THE CLOCK] is displayed
→ go to step 4

2 Touch [LANGUAGE SET]

3 Touch the language you wish to set

- Touch ▲▼ on the screen to change the page. Zoom lever can also be used to change the page.

4 If [PLEASE SET THE CLOCK] is displayed Touch [CLOCK SET]

5 Setting date and time and display format

- Setting the date and time
→ Touch ▲▼ on the screen to set
- Setting the date display format
→ Touch ◀▶ on the screen and choose from [M/D/Y], [D/M/Y] or [Y/M/D]
- Setting the time display format
→ Touch ◀▶ on the screen and choose from [AM/PM] or [24HRS]
- To cancel → Touch [CANCEL]
- When set to [AM/PM], 0:00 midnight is AM 12:00, and 0:00 noon is PM 12:00.

Setting the clock (Continued)

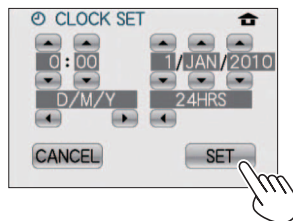

6 Touch [SET]

7 Touch [SET]

- To return to the previous screen → Touch [CANCEL]
- Turn on power again and check time display.
(Time and date can be displayed by pressing [DISPLAY] several times.)

- To set local time at travel destination
[WORLD TIME] (→54)

To change time setting

- Touch [CLOCK SET] from the [SETUP] menu to change the clock settings.
- Clock settings will be saved for approx. 3 months even after battery is removed, provided a fully-charged battery was installed in the camera for 24 hours beforehand.

- 1 Touch [CLOCK SET] from the [REC] menu or [SETUP] menu (→18)
- 2 Set the date and time (steps 5 and 6) (→13)

- Failure to set the date and time will cause the date/time to be improperly printed when printing pictures in a digital photo centre or when using [TEXT STAMP].
- Year can be set between 2000 and 2099.
- After the time has been set, the date can be printed correctly even if the date is not displayed on the camera screen.

Setting the menu

There are a number of functions you can use and settings you can change from the various menus to help you get more use from your camera.

- Settings display may vary according to items.
- Menu items displayed vary according to the mode.

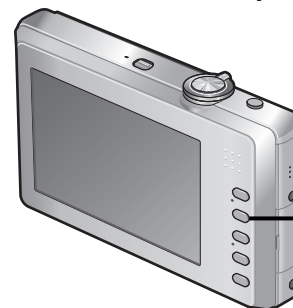
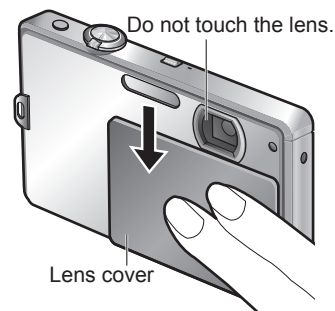

1 Open the lens cover

The power is turned on.

2 Select [NORMAL PICTURE] Mode

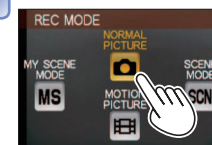

- ① Press the [MODE] button.
- ② Touch ([NORMAL PICTURE] Mode)

- To display the [PLAYBACK] menu, press the Playback button to switch to Playback Mode.

3 Display the menu screen



4 Touch the type of menu (→16) to switch between them

- When in Playback Mode, the [PLAYBACK] menu is displayed in place of the [REC] menu.



Menu type

- : [REC] menu (Recording Mode only)
- : [PLAYBACK] menu (Playback Mode only)
- : [SETUP] menu

Setting the menu (Continued)



item

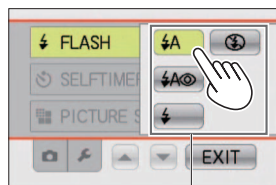

settings

■ To reset default settings

[RESET] (→21)

5 Touch a menu item

- Touch ▲▼ on the screen to change the page. Zoom lever can also be used to change the page.
- Touch [EXIT] to return to the original screen.

6 Touch the settings you wish to change

- The setting is changed.
- The procedure for making settings varies by menu.

7 Touch [EXIT]

- Also if the shutter button is pressed halfway during an operation, the display will return to the original screen.

Menu type

📷 [REC] menu (Recording Mode only)

Changing picture preferences (→56 - 62)

- Enables you to specify colour, sensitivity, pixel level, and other settings.



📺 [PLAYBACK] menu (Playback Mode only)

Using your pictures (→70 - 77)

- Enables you to specify picture protection, cropping, and printing settings for pictures you have taken.

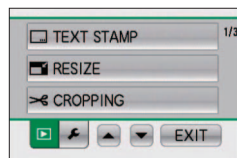

⚙️ [SETUP] menu

Making the camera more convenient to use (→18 - 23)

- Enables you to specify settings related to usability. Adjust the clock, change the beep sounds, and so on.

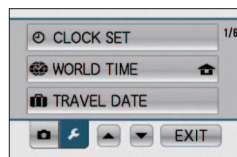

Using Quick menu

Recording menu items can be called up easily.

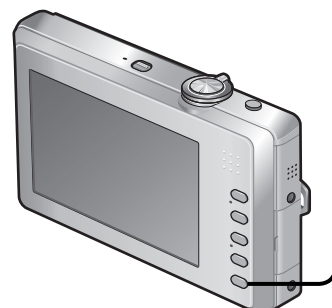

1 In Recording Mode, display the Quick menu

- Q.MENU Press the button until the Quick menu is displayed



Quick menu

2 Touch a menu item

3 Touch the settings you wish to change



Settings

- Touch [EXIT] to return to the original screen.











● Setting items displayed vary depending on Recording Mode.







Using the [SETUP] menu

For details about the setting procedure in the [SETUP] menu. (→15)

For details about the setting procedure in the [SETUP] menu. (→15)
Make general camera settings such as adjusting the clock, extending the battery life, and changing the beep sounds.

[CLOCK SET], [AUTO REVIEW] and [AUTO POWER OFF] are important for clock setting and battery life. Please check these before use.



Item	Settings, notes
 [CLOCK SET] Set the date and time. (→13)	Set time, date, and display format.
 [WORLD TIME] Set the local time at travel destination. (→54)	 [DESTINATION]: Set the local time at travel destination.  [HOME]: Set date and time at home area.
 [TRAVEL DATE] Record the number of days elapsed in your travels. (→53)	[TRAVEL SETUP] [OFF]/[SET] (Register departure and return dates.) [LOCATION] [OFF]/[SET] (Input name of destination.) (→63)
 [BEEP] Change or mute the beep/shutter sounds.	[BEEP LEVEL]  : Mute/Low/High [BEEP TONE]  : Change beep tone. [SHUTTER VOL.]  : Mute/Low/High [SHUTTER TONE]  : Change shutter tone.
 [VOLUME] Adjust volume of sound from speakers (7 levels).	0 •• [LEVEL3] •• [LEVEL6] • Cannot be used to adjust TV speaker volume when connected to TV. (We recommend setting camera volume to 0)





Item	Settings, notes
 [LCD MODE] Make LCD monitor easier to see.	[OFF]: Normal (cancel setting)  [AUTO POWER LCD]: The brightness is adjusted automatically depending on how bright it is around the camera.  [POWER LCD]: Makes screen brighter than normal (for outdoor use).  [HIGH ANGLE]: Makes screen easier to see when taking pictures from high positions. (becomes harder to see from the front) • [AUTO POWER LCD] is disabled in the following situations. During Playback Mode or menu screen display, or when connected to computer/printer. • [POWER LCD] will be deactivated if no operations are performed for 30 seconds while recording. (Brightness can be restored by pressing any button) • [HIGH ANGLE] will be cancelled when power is turned off (including [AUTO POWER OFF]). • Brightness/colour of screen in [LCD MODE] has no effect on pictures recorded. • Block out sunlight (with hand, etc.) if reflection makes screen difficult to see. • [AUTO POWER LCD] and [HIGH ANGLE] are not available in Playback Mode. • Selecting [AUTO POWER LCD] or [POWER LCD] will reduce the number of pictures available and battery life.
 [FOCUS ICON] Change the focus icon.	

Using the [SETUP] menu (Continued)





For details about the setting procedure in the [SETUP] menu. (→15)



For details about the setting procedure in the [SETUP] menu. (→15)

Item	Settings, notes
 [AUTO POWER OFF] The camera turns off automatically after a specified period of inactivity.	[OFF]/[2 MIN.]/[5 MIN.]/[10 MIN.] <ul style="list-style-type: none"> • Not used in the following situations: When an AC adaptor (optional) is used, when connected to a computer or printer, during motion picture recording or playback, and during Slide Shows or demos • Specific periods apply in the following situations. [INTELLIGENT AUTO] Mode: [5 MIN.], and when a Slide Show is paused: [10 MIN.]
 [AUTO REVIEW] Automatically display still pictures immediately after taking them.	[OFF]: No auto review [1 SEC.]/[2 SEC.]: Automatically display for 1 or 2 seconds. [HOLD]: Auto review screen remains until a button (other than the [DISPLAY] button) is pressed <ul style="list-style-type: none"> • Fixed to [2 SEC.] in [INTELLIGENT AUTO] Mode. • Auto review occurs immediately after still pictures taken in [BURST] Mode and in the Scene Modes [SELF PORTRAIT], [HI-SPEED BURST], [FLASH BURST], and [PHOTO FRAME], regardless of settings. • Motion pictures cannot be automatically reviewed.

Item	Settings, notes
 [RESET] Reset to the default settings.	[RESET REC. SETTINGS?] [YES]/[NO]
	[RESET SETUP PARAMETERS?] [YES]/[NO] <ul style="list-style-type: none"> • Resetting the setup parameters will also reset the following: <ul style="list-style-type: none"> - Age in years/months and names in Scene Modes [BABY] and [PET] - [TRAVEL DATE] - [WORLD TIME] - [FAVORITE] in [PLAYBACK] menu (set to [OFF]) - [ROTATE DISP.] (set to [ON]) • Folder numbers and clock settings will not be reset. • Camera movement may be audible as the lens function is reset. This is not a fault.
 [USB MODE] Select communication method for when connecting camera to a computer or printer with USB connection cable.	 [SELECT ON CONNECTION]: Select [PC] or [PictBridge (PTP)] each time you connect to a computer or PictBridge-compatible printer  [PictBridge (PTP)]: Select when connecting to a PictBridge-compatible printer  [PC]: Select when connecting to a computer

For details about the setting procedure in the [SETUP] menu. (→15)

Item	Settings, notes
 [VIDEO OUT] Change the video output format when connected to a TV, etc. (Playback Mode only).	[NTSC]/[PAL] <ul style="list-style-type: none"> Operates when AV cable is connected.
 [TV ASPECT] Change the aspect ratio when connected to a TV, etc. (Playback Mode only).	16:9 / 4:3 <ul style="list-style-type: none"> Operates when AV cable is connected.
 [VERSION DISP.] Check the version of the camera firmware.	Current version is displayed.
 [FORMAT] Use when [BUILT-IN MEMORY ERROR] or [MEMORY CARD ERROR] appears, or when formatting the built-in memory or card. When a card/built-in memory is formatted, the data cannot be restored. Check the content of the card/built-in memory carefully before formatting.	[YES]/[NO] <ul style="list-style-type: none"> This requires a sufficiently charged battery (→9) or AC adaptor (optional). When formatting the built-in memory, remove any cards. (Only inserted card will be formatted if present; built-in memory will be formatted if no card is inserted.) Always format cards with this camera. All picture data including protected pictures will be deleted. (→76) Do not turn off power or perform other operations during formatting. Formatting the built-in memory may take several minutes. Consult your nearest Service Centre if format cannot be successfully completed.

Item	Settings, notes
 [LANGUAGE] Change display language.	Set the language displayed on the screen.
DEMO [DEMO MODE] View demonstration of functions.	[STABILIZER DEMO.]: (Only during recording) Indicates the extent of jitter detected by the camera (Estimate) Large ← Small → Large  Extent of jitter  Extent of jitter after stabilization <ul style="list-style-type: none"> When the demo screen is displayed, touch [STABILIZER] to switch the Optical Image Stabilizer between [ON] and [OFF]. Cannot be displayed in Playback Mode. To stop → Touch [EXIT] Recording and zoom cannot be performed during demo.
	[AUTO DEMO]: View introductory Slide Show [OFF]/[ON] <ul style="list-style-type: none"> To close → Press [MENU] If the camera is left switched on while connected to the AC adaptor (optional) and with no card inserted, the demo will automatically begin whenever no operations are performed for approx. 2 minutes. [AUTO DEMO] cannot be displayed on external devices such as TVs.

Sequence of Recording

Please set the clock before recording. (→13)

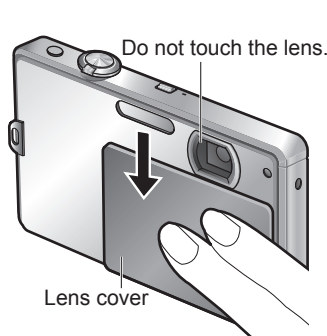

1 Open the lens cover

The power is turned on.

2 Select the desired Recording Mode and record

■ To use settings automatically selected by the camera

① Press the **iA** button.

■ To select the Recording Mode manually

① Press the [MODE] button.

② Touch the desired Recording Mode.

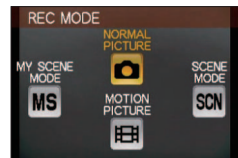

3 Press the Playback button and view pictures (→32)

■ To return to the Recording Mode

① Press the Playback button again.
• The camera returns to the previous Recording Mode.

4 Close the lens cover

The power is turned off.

• The power can also be turned off by pressing the Power button.

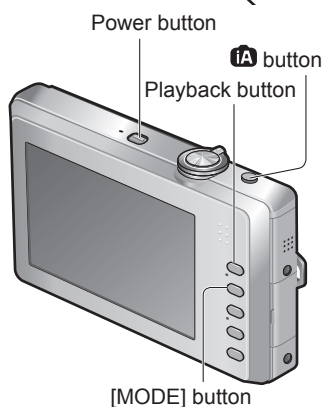

■ Recording Mode list

iA	[INTELLIGENT AUTO] Mode	Take pictures with automatic settings.	(→26)
📷	[NORMAL PICTURE] Mode	Take pictures with your own settings.	(→28)
MS	[MY SCENE MODE]	Take pictures in commonly used Scene Modes.	(→50)
SCN	[SCENE MODE]	Take pictures according to scene.	(→42)
🎬	[MOTION PICTURE] Mode	Take motion pictures.	(→51)

■ Holding the camera

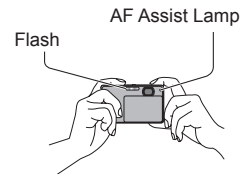

- If jitter becomes noticeable, use both hands, keep your arms close to your body, and stand with your feet at shoulder width.
- Do not touch the lens.
- Do not block the microphone when recording motion picture. (→7)
- Do not block the flash or the AF Assist Lamp. Do not look at it from close range.
- Try to hold the camera steady when you press the shutter button.

Convenient ways to turn the power on

Besides opening the lens cover, you can also turn the power on as follows.

■ To turn the power on in Playback Mode

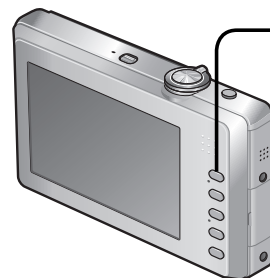

▶ Hold

Pictures on the card or built-in memory are displayed.

■ With the lens cover opened and the power off

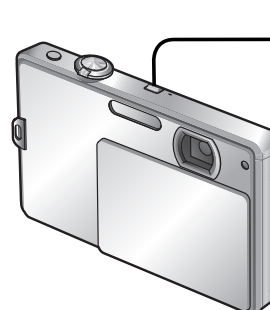

OFF/ON Hold

The camera will turn on in Recording Mode.
• When the Power button is held with the lens cover closed, a message [PLEASE OPEN THE LENS COVER] is displayed.

Taking pictures with automatic settings

[INTELLIGENT AUTO] Mode

Recording Mode: **iA**

Optimum settings are made automatically from information such as 'face,' 'movement,' 'brightness,' and 'distance' just by pointing the camera at the subject, meaning that clear pictures can be taken without the need to make settings manually.

1 Open the lens cover
The power is turned on.

2 Select [INTELLIGENT AUTO] Mode
• Press again to return to the previous Recording Mode.

3 Take pictures
Press halfway (press lightly to focus) → Press fully (press the button all the way to record)

Focus display
(when focus aligned: flashing → illuminated)

The type of scene detected is indicated by a blue icon for two seconds

Automatic scene detection

Camera identifies the scene when pointed at the subject, and makes optimum settings automatically.

[i] PORTRAIT: People are detected	[i NIGHT PORTRAIT]: People and night scenery are detected (Only when iA is selected)
[i] SCENERY: Scenery is detected	[i NIGHT SCENERY]: Night scenery is detected
[i] MACRO: A close-up shot is detected	[i] SUNSET: A sunset is detected
iA Reads subject movement to avoid blurring when scene does not correspond to any of the above.	

If the camera automatically identifies the scene and determines that people appear as subjects in the picture (or) , Face Detection is activated, and the focus and exposure are adjusted for the recognised faces.

To use flash

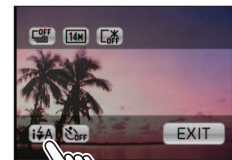

- 1 Touch **iA** on the Quick menu (→17)**
• You can also set by touching [FLASH] in the [REC] menu.
- 2 Touch **iA****
• If you are not going to use flash, touch .
• Touch [EXIT] to return to the original screen.
• When **iA** is used, **iA**, **iA** (Auto/Red-Eye Reduction), **iA** (Slow Sync./Red-Eye Reduction) and **iA** (Slow Sync.) are selected automatically according to the subject type and brightness. (For details (→37))
• **iA** and **iA** indicate that digital red-eye correction is activated.
• The shutter speed is slower in **iA** and **iA**.

- In addition to automatic scene detection, [**F ISO**] in [SENSITIVITY] and backlight compensation will operate automatically.
- The following menu items may be set in [INTELLIGENT AUTO] Mode:
 - **iA** ([REC] menu): [FLASH], [SELF TIMER], [PICTURE SIZE]*1, [BURST], [COLOR MODE]*1
 - ([SETUP] menu*2): [CLOCK SET], [WORLD TIME], [BEEP]*1, [LANGUAGE], [STABILIZER DEMO.]
- *1 Items that may be set differ from other Recording Modes.
- *2 Other items in the [SETUP] menu will reflect settings made in other Recording Modes.
- According to the following conditions, different scene types may be determined for the same subject:
 - Face contrast, conditions of subject (size, distance, colouring, contrast, movement), zoom ratio, sunset, sunrise, low brightness, jitter
- If desired scene type is not selected, we recommend manually selecting the appropriate Recording Mode. (Scene Mode: (→42))
- Backlight compensation
Backlight refers to the light that shines from behind the subject. When this occurs, the subject appears darker, and so backlighting is automatically corrected by increasing the brightness of the entire image.
- We recommend using a tripod and the self-timer with [i NIGHT SCENERY] and [i NIGHT PORTRAIT].
- When jitter is small (e.g. using tripod) with [i NIGHT SCENERY], shutter speed can reach a maximum of 8 seconds. Do not move the camera.
- The settings for the following functions are fixed:
 - [AUTO REVIEW]: [2 SEC.]
 - [AUTO POWER OFF]: [5 MIN.]
 - [WHITE BALANCE]: [AWB]
 - [STABILIZER]: [AUTO]
 - [AF MODE]: (Face Detection)*3
 - [AF ASSIST LAMP]: [ON]
- *3 (9-area-focusing) when face cannot be recognised
- The following functions cannot be used: [EXPOSURE], [DIGITAL ZOOM]

Taking pictures with your own settings

[NORMAL PICTURE] Mode

Recording Mode:

Using the [REC] menu to change settings and set up your own recording environment.

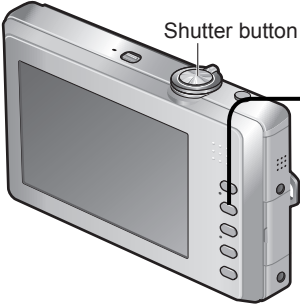

Shutter button

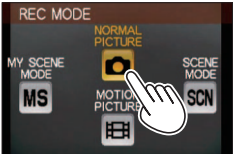
- 1 Open the lens cover**
The power is turned on.
- 2 Display the screen for Recording Mode selection**
MODE
- 3 Touch [NORMAL PICTURE]**

■ **To use zoom**

(→30)

■ **To use flash**

(→36)

■ **To adjust picture brightness**

(→41)

■ **To take close-up pictures**

(→38)

■ **To adjust colouring**

(→61)

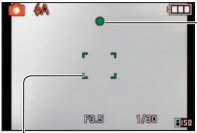
- 4 Take a picture**

 Press halfway (press lightly to focus) → Press fully (press the button all the way to record)

Focus display
 (when focus aligned: flashing → illuminated)
 AF area
 (aligns focus with subject; when complete: red → green)

- If a warning is displayed about jitter, use [STABILIZER], a tripod, or [SELFTIMER].
- If aperture value or shutter speed is displayed in red, correct exposure has not been achieved. Use flash or change [SENSITIVITY] settings.



Jitter alert display

Aperture value Shutter speed

Align focus for desired composition

Useful when subject is not in centre of picture.

1 First adjust focus according to subject

Align the AF area with the subject



Hold down halfway



AF area

- Subjects/environments which may make focusing difficult:
 - Fast-moving or extremely bright objects, or objects with no colour contrast.
 - Taking pictures through glass or near objects emitting light. In the dark, or with significant jitter.
 - When too close to object or when taking pictures of both distant and close objects together in the same picture.
- We recommend using the 'Face Detection' function when taking pictures of people (→58).

2 Return to desired composition



Press fully



AF area

- The focus display flashes and beep sounds when focus is not aligned. Use the focus range displayed in red as a reference. Even if the focus display is lit, the camera may be unable to bring the subject into focus if it is out of range.
- AF area is displayed larger in dark conditions or when using Digital Zoom.
- Most displays are temporarily cleared from screen when the shutter button is pressed halfway.

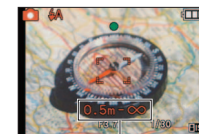

Focus range

Direction detection function

Still pictures taken with the camera held vertically are automatically played back vertically. (Only when [ROTATE DISP.] is set to [ON])

- Still pictures taken with the lens surface facing directly up or down and still pictures taken on other cameras may not be rotated. Additionally, still pictures taken while holding the camera upside down are not rotated automatically.
- Motion pictures are not displayed vertically.

Taking pictures with zoom

Recording Mode: MS SCN

'Optical Zoom' offers 4 x magnification. At a lower recording pixel level, 'Extra Optical Zoom' can be used to zoom up to 8.4 x. For zooming in even closer, 'Digital Zoom' is available.

1 Zoom In/Out

Capture a wider area (wide-angle) Enlarge the subject area (telephoto)

W side (wide-angle): 1 x T side (telephoto): up to 4 x

Focus range Zoom ratio (approx.)

Zoom bar

- Adjust the focus after adjusting the zoom.

Optical Zoom and Extra Optical Zoom (EZ)

Automatically switches to 'Optical Zoom' when using maximum picture size (→56), and to 'Extra Optical Zoom' (for further zooming) otherwise. (EZ is short for 'Extra Optical Zoom'.)

• Optical Zoom



• Extra Optical Zoom



Maximum zoom ratios by picture size

	Optical Zoom	Extra Optical Zoom		
[PICTURE SIZE]	14 M - 10.5 M	10 M	5 M	3 M or less
Max. enlargement	4 x	4.7 x	6.8 x	8.4 x

Extra Optical Zoom system

When the recording pixel level is set to [3 M] (corresponding to 3 million pixels), 3 million pixels of the available pixel level in the centre of the CCD are used in recording, enabling higher magnification.

• The enlargement ratio displayed in the bar on screen is an estimate.

Enlarging further [DIGITAL ZOOM]

Zoom 4 times further than Optical/Extra Optical Zoom.
(Note that, with Digital Zoom, enlarging will lessen picture quality.)

1 Display [REC] menu (→15)

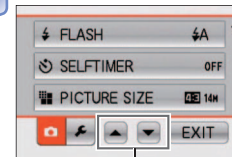

Touch repeatedly until the desired item is displayed.

3 Touch [ON]

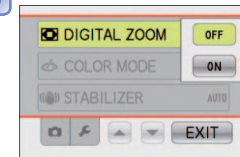

2 Touch [DIGITAL ZOOM]



4 Touch [EXIT]

Digital Zoom area is displayed within zoom bar on screen.

e.g. With 16 x

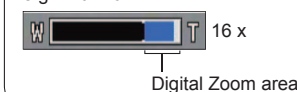

- Zoom motion stops momentarily when entering Digital Zoom range.
- Within Digital Zoom range, AF area is displayed larger when the shutter button is pressed halfway.
- We recommend using a tripod and [SELFTIMER].

- A greater degree of distortion may be generated by taking wider-angled pictures of close objects, while using more telescopic zoom may result in more colouring appearing around the outlines of objects.
- The camera may make a rattling noise and vibrate when the zoom lever is operated – this is not a fault.
- When Extra Optical Zoom is used, zooming momentarily stops partway, but this is not a malfunction.
- Extra Optical Zoom cannot be used in the following cases: [MACRO ZOOM], Motion Picture, [TRANSFORM], [HIGH SENS.], [HI-SPEED BURST], [FLASH BURST], and [PHOTO FRAME] Scene Modes
- Digital Zoom cannot be used in the following modes:
 - ([INTELLIGENT AUTO] Mode)
 - [TRANSFORM], [HIGH SENS.], [HI-SPEED BURST], [FLASH BURST], [FILM GRAIN] and [PHOTO FRAME] Scene Modes

Viewing your pictures [NORMAL PLAY]

Playback Mode:

When a card is in the camera, pictures are played back from the card, and without a card, pictures are played back from the built-in memory.

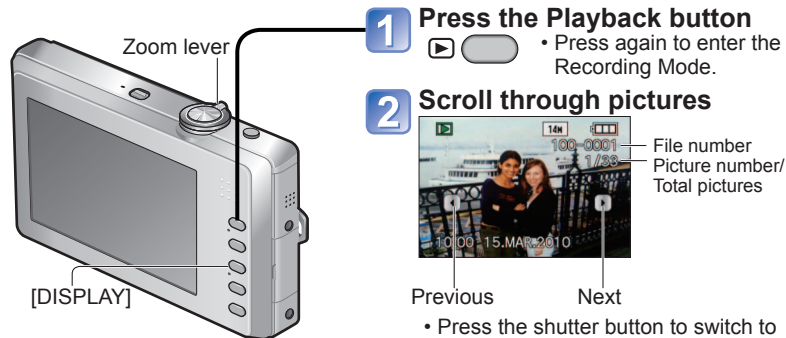

■ To enlarge (Playback zoom)



Current zoom position (displayed for 1 sec.)

- Each time you turn the zoom lever towards the T side or touch , the magnification increases through four levels after 1x: 2x, 4x, 8x, and 16x. (The picture quality displayed becomes successively lower.)
- To reduce zoom
 → Turn lever towards W side or touch
- Move zoom position
 → Touch on the screen

- You can also go to the next or previous picture by dragging the center of the screen.
 To go to the next picture: Drag from left to right
 To go to the previous picture: Drag from right to left
- If file number is not displayed, press the [DISPLAY] button.
- After the final picture, display returns to the first picture.
- Some pictures edited on a computer may not be able to be viewed on this camera.
- This camera is compliant with the unified DCF (Design rule for Camera File system) standard formulated by the Japan Electronics and Information Technology Industries Association (JEITA), and with Exif (Exchangeable image file format). Files that are not DCF-compliant cannot be played back.

■ To playback as list

(Multi Playback/Calendar Playback) (→64)

■ To view with different Playback Modes

(Slide Show, etc.) (→66)

■ To playback motion pictures (→65)

Deleting pictures

Playback Mode:

Pictures will be deleted from the card if card is inserted, or from the built-in memory if the card is not inserted. (Deleted pictures cannot be recovered.)

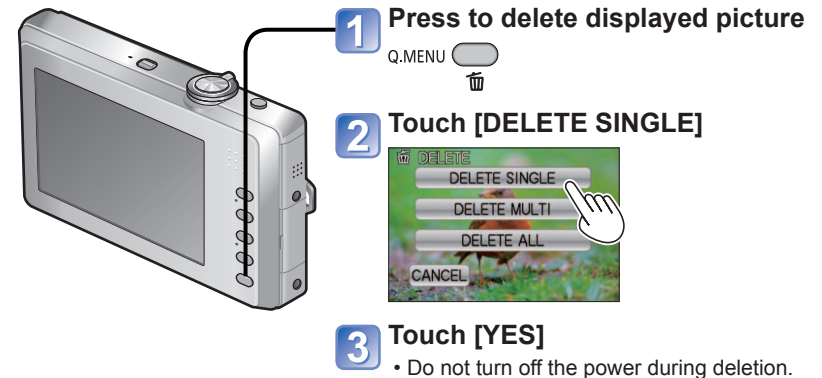

To delete multiple (up to 50) or all pictures

(after step 1)

2 Touch [DELETE MULTI] / [DELETE ALL]

- To use [DELETE ALL] → go to step 5

3 Touch pictures to be deleted

- To cancel the selection → Touch the picture again
- To change the screen → Touch on the screen



4 Touch [OK]

5 Touch [YES]

- To cancel → Touch [CANCEL]
- May take time depending on number of pictures deleted.
- [ALL DELETE EXCEPT ★] may be selected in [DELETE ALL] when [FAVORITE] is set to [ON] (→74) and pictures have been registered.

- Use a sufficiently charged battery or an AC adaptor (optional).
- Pictures cannot be deleted in the following cases:
 - Protected pictures
 - Card switch is in 'LOCK' position.
 - Pictures not of DCF standard (→32)
- Motion pictures can also be deleted.
- To delete all data including protected pictures, perform [FORMAT].

Changing recording information display

You can switch between various information shown on the LCD monitor, such as guide lines and recording information.

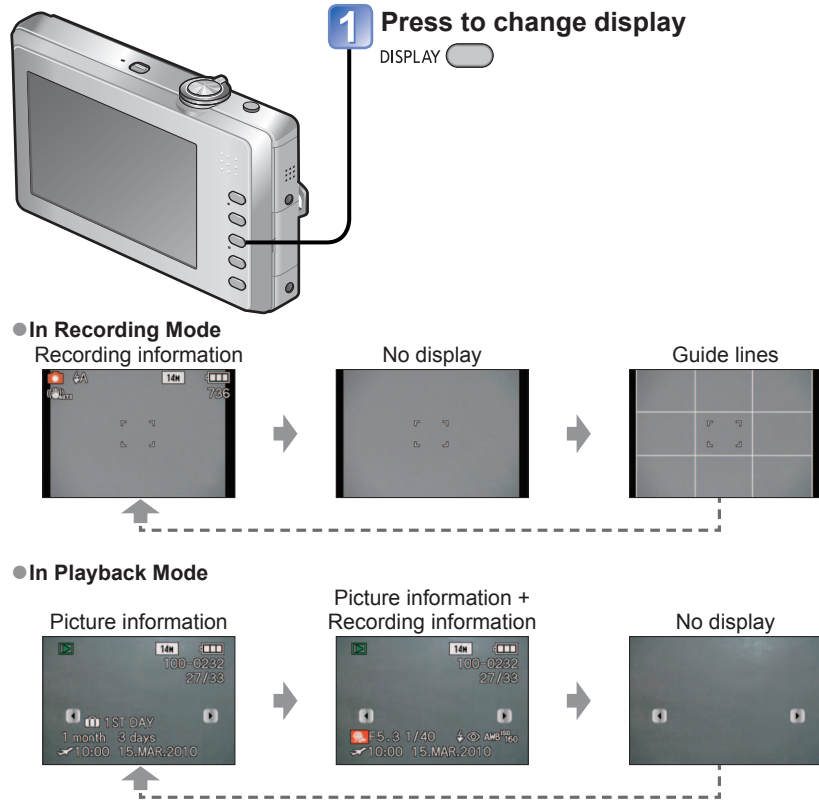

■ Guide lines

- Reference for composition (e.g. balance) when recording.



- During menu display, Multi Playback or Calendar Playback: Display cannot be changed.
- Guide lines are not displayed in [PHOTO FRAME] Scene Mode.

Taking pictures with the self-timer

Recording Mode:   MS SCN

We recommend using a tripod. This is also effective for correcting jitter when pressing the shutter button, by setting the self-timer to 2 seconds.

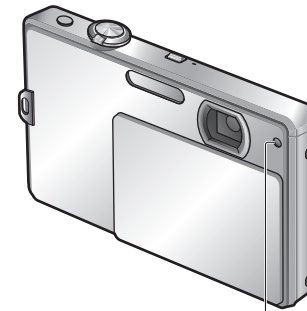

Self-timer indicator
(Flashes for set time duration)

1 Touch on the Quick menu (→17)

- You can also set by touching [SELFTIMER] in the [REC] menu.

2 Touch the time to be set

- If you are not going to use the self-timer, touch  [OFF].
- Touch [EXIT] to return to the original screen.

3 Take a picture

Press the shutter button fully to start recording after the preset time.



- To cancel while in operation → Touch [CANCEL].

- When set to [BURST], three pictures are taken. When set to the [FLASH BURST] Scene Mode, five pictures are taken.
- Focus will be automatically adjusted immediately before recording if shutter button is pressed fully.
- After self-timer lamp stops flashing, it may then be lit for AF Assist Lamp.
- This function cannot be used in [HI-SPEED BURST] Scene Mode.
- In [SELF PORTRAIT] Scene Mode, [10SEC.] is not available.

Taking pictures with flash

Recording Mode: MS SCN



1 Touch on the Quick menu (→17)

- You can also set by touching [FLASH] in the [REC] menu.

2 Touch the type of flash

- Touch [EXIT] to return to the original screen.

- Stand at least 1 m (3.28 feet) away when using the flash to take pictures of infants.

Type, operations	Uses
[AUTO] • Automatically judges whether or not to flash	Normal use
[AUTO/RED-EYE]*1 • Automatically judges whether or not to flash (reduce red-eye)	Taking pictures of subjects in dark places
[FORCED FLASH ON] • Always flash	Taking pictures with backlight or under bright lighting (e.g. fluorescent)
[FORCED ON/RED-EYE]*1 • Always flash (reduce red-eye)	
[SLOW SYNC./RED-EYE]*1 • Automatically judges whether or not to flash (reduce red eye; slow shutter speed to take brighter pictures)	Taking pictures of subjects against a nightscape (tripod recommended)
[FORCED FLASH OFF] • Never flash	Places where flash use is prohibited

*1 The flash is activated twice. Be sure to stop moving before the second flash. Note that the interval of flashes varies depending on the subject brightness. When [RED-EYE REMOVAL] is activated in the Recording menu, the icon is displayed, red-eye is automatically detected, and the still picture data is corrected. (Only when [AF MODE] is : (Face Detection).)

- Shutter speeds are as follows:
 - : 1/30 - 1/1600th
 - : 1/8*2 - 1/1600th
- *2 Max. 1/4 sec. when [ISO] in [SENSITIVITY] is set; max. 1 sec. when [STABILIZER] is set to [OFF] or when blur is insignificant. Also varies according to [INTELLIGENT AUTO] Mode, [SCENE MODE] scene, and zoom position.
- The effect of red-eye reduction varies depending on the subject and is affected by factors such as distance to the subject, whether the subject is looking at the camera during preliminary flash, and so on. In some cases, the effect of red-eye reduction may be negligible.

■ Available types in each mode (○: Available, —: Not available, : Default setting)

			[SCENE MODE]															
	○	○*	○	○	○	○	○	○	○	○	○	○	○	○	○	○	○	
	○	—	○	○	○	○	○	○	○	○	○	○	○	○	○	○	○	
	○	—	○	○	○	○	○	○	○	○	○	○	○	○	○	○	○	
	—	—	—	—	—	—	—	—	—	—	—	—	—	—	—	—	—	
	—	—	—	—	—	—	—	—	—	—	—	—	—	—	—	—	—	
	○	○	○	○	○	○	○	○	○	○	○	○	○	○	○	○	○	

* Set to (Auto), (Auto/Red-Eye Reduction), (Slow Sync./Red-Eye Reduction) or (Slow Sync.) according to the subject and brightness.

- The flash cannot be used in Motion Picture Mode and in these Scene Modes: and .

■ Focus range according to ISO Sensitivity and zoom

		Focus range	
		Max. W	Max. T
[SENSITIVITY] (→57)	[ISO]	Approx. 0.3 m - 4.9 m (0.99 feet - 16.08 feet)	Approx. 0.5 m - 2.9 m (1.64 feet - 9.51 feet)
	ISO80	Approx. 0.3 m - 1.0 m (0.99 feet - 3.28 feet)	Approx. 0.5 m - 0.6 m (1.64 feet - 1.97 feet)
	ISO100	Approx. 0.3 m - 1.2 m (0.99 feet - 3.94 feet)	Approx. 0.5 m - 0.7 m (1.64 feet - 2.29 feet)
	ISO200	Approx. 0.4 m - 1.7 m (1.32 feet - 5.58 feet)	Approx. 0.5 m - 1.0 m (1.64 feet - 3.28 feet)
	ISO400	Approx. 0.6 m - 2.4 m (1.97 feet - 7.87 feet)	Approx. 0.6 m - 1.4 m (1.97 feet - 4.59 feet)
	ISO800	Approx. 0.8 m - 3.4 m (2.62 feet - 11.2 feet)	Approx. 0.6 m - 2.0 m (1.97 feet - 6.56 feet)
[HIGH SENS.] in [SCENE MODE] (→47)	ISO1600-ISO6400	Approx. 1.15 m - 9.8 m (3.77 feet - 32.15 feet)	Approx. 0.9 m - 5.8 m (2.96 feet - 19.03 feet)
[FLASH BURST] in [SCENE MODE] (→48)	ISO100-ISO3200	Approx. 0.3 m - 3.2 m (0.99 feet - 10.50 feet)	Approx. 0.5 m - 1.9 m (1.64 feet - 6.23 feet)

- Do not touch or look at the flash (→7) from close distances (i.e. a few cm). Do not use the flash at close distances to other subjects (heat/light may damage subject).
- Flash settings may be changed when changing Recording Mode.
- When [ISO] is set in [SENSITIVITY], the ISO Sensitivity is automatically set in a range up to 1600.
- Scene Mode flash settings are restored to default when Scene Mode is changed.
- If flash is to be emitted, flash type marks (e.g.) will turn red when shutter button is pressed halfway.
- No pictures may be taken if these marks (e.g.) are flashing (flash is charging).
- Insufficient flash reach may be due to inadequately set exposure or White Balance.
- Flash effect may not be fully achieved with high shutter speeds.
- Flash charging may take time if battery is low, or if using flash repeatedly.

Taking close-up pictures

Recording Mode:

When you want to enlarge the subject, setting to [AF MACRO] (AF) enables you to take pictures at an even closer distance than the normal focus range (up to 10 cm (0.33 feet) for max. W).



1 Touch on the Quick menu (→17)

- You can also set by touching [MACRO MODE] in the [REC] menu.

2 Touch [AF MACRO]

- To cancel macro recording, touch [OFF].
- Touch [EXIT] to return to the original screen.

3 Take a picture

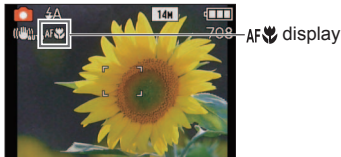

- It may take some time until distant subjects come into focus.
- When using ([INTELLIGENT AUTO] Mode), macro recording can be activated by just pointing the camera at the subject. (display)

Focus range for AF Macro Mode

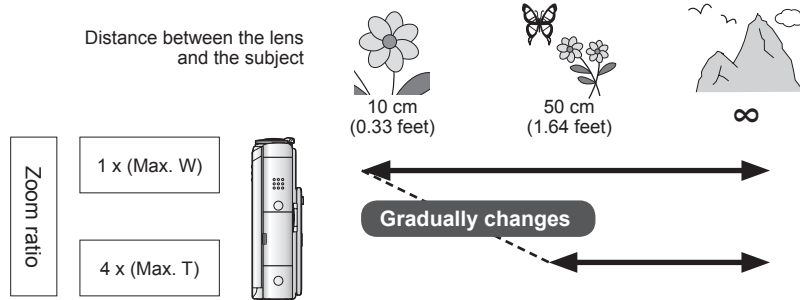

- During [MACRO ZOOM] recording, the focus range is 10 cm (0.33 feet) to infinity, regardless of the zoom position.

Taking pictures at even closer range [MACRO ZOOM]

To take even larger pictures of the subject, setting to [MACRO ZOOM] enables the subject to appear even larger than when using [AF MACRO].



1 Touch on the Quick menu (→17)

- You can also set by touching [MACRO MODE] in the [REC] menu.

2 Touch [MACRO ZOOM]

- To cancel macro recording, touch [OFF].
- Touch [EXIT] to return to the original screen.

3 Adjust the Digital Zoom magnification with the zoom lever

The zoom position is fixed at the Wide end. Focus range is 10 cm (0.33 feet) - ∞.

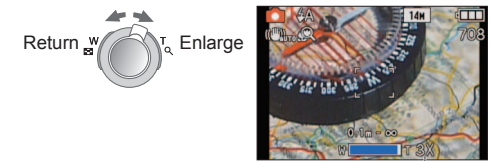
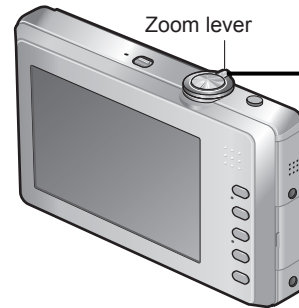

Digital Zoom magnification (1 x to 3 x)

4 Take a picture

- In [MACRO ZOOM], higher magnification results in lower picture quality.
- When zoomed macro is specified, Extra Optical Zoom is disabled.
- We recommend using a tripod, [SELFTIMER], or setting [FLASH] to [FORCED FLASH OFF].
- Moving the camera after aligning the focus is likely to result in poorly focused pictures if subject is close to the camera, due to the margin for focus alignment being severely reduced.
- The resolution outside the area in focus may be lower.

Taking pictures with the Touched Area in Focus

(Touch AF Area Selection)

Recording Mode: MS SCN

You can adjust the focus to the place on the screen you touch.

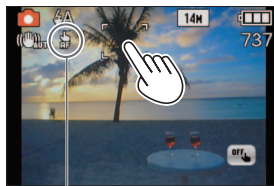

displayed

1 Touch the subject

- When the subject is recognized, the AF area is displayed and the camera focuses.
- If is touched, Touch AF Area Selection is cancelled.
- Focusing may not work if you touch the edge of the screen.

2 Take a picture

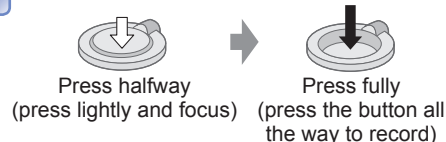

- Touch AF Area Selection may not be effective in the following cases.
 - When the subject is too small
 - When the recording place is too dark
 - When the subject is moving quickly
 - When there are other subjects or a background of similar colour as the subject
 - When the camera is shaking
 - When using zoom
- If Touch AF Area Selection fails, the AF area blinks red and then goes out. Try touching the screen again.
- If Touch AF Area Selection does not work, [AF MODE] will record with (1-area focusing).
- During [INTELLIGENT AUTO] Mode, the camera will determine the touched subject to be the optimal scene.
- Touch AF Area Selection will not work in the following cases.
 - Scene Modes [STARRY SKY], [FIREWORKS]
 - Motion Picture Recording Mode

Taking pictures with exposure compensation

Recording Mode: MS SCN

Corrects exposure when adequate exposure cannot be obtained (if difference between brightness of object and background, etc.). Depending on the brightness, this may not be possible in some cases.

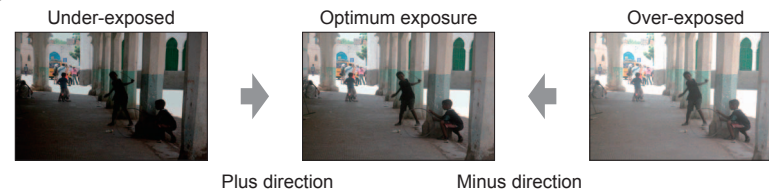

1 Touch on the Quick menu (→17)

- You can also set by touching [EXPOSURE] in the [REC] menu



2 Touch

- If you are not going to use exposure compensation, select 0.

3 Touch [EXIT]

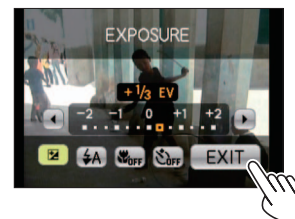

- After exposure adjustment, the adjustment value (+1/3 for example) is displayed in the bottom-left corner of the screen.
- The exposure compensation value you set is retained even after the camera is turned off.
- Exposure compensation cannot be used with the [STARRY SKY] Scene Mode.

Taking pictures according to the scene

[SCENE MODE]

Recording Mode: MS SCN

Using [SCENE MODE] enables you to take pictures with optimum settings (exposure, colouring, etc.) for given scenes.

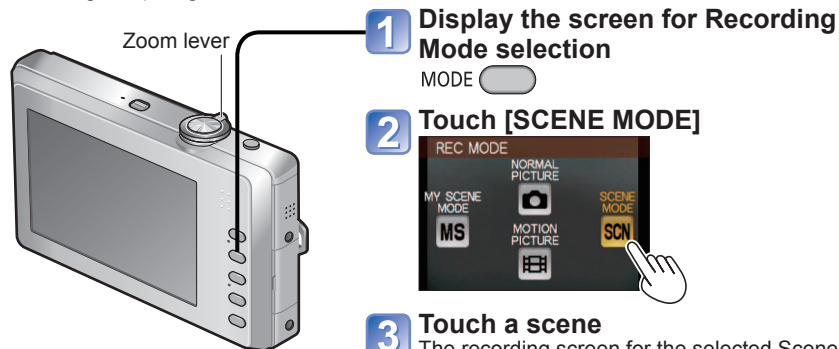

■ Registering commonly used scenes

[MY SCENE MODE] (→50)

■ When the description is ON ()

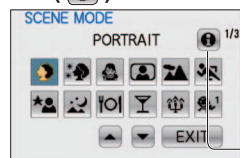

Touch to turn description ON/OFF

When a scene is touched, a scene description is displayed.

When [SET] is touched, the recording screen of the [SCENE MODE] is displayed.

- Reselect a scene → Touch [CANCEL]

- Selecting a Scene Mode inappropriate for the actual scene may affect the colouring of your picture.
- The following [REC] menu settings will be automatically adjusted and cannot be selected manually (available settings vary according to scene setting): [SENSITIVITY], [MACRO MODE], [COLOR MODE]
- White Balance can only be set in the next scene.
[PORTRAIT], [SOFT SKIN], [TRANSFORM], [SELF PORTRAIT], [SPORTS], [BABY], [PET], [HIGH SENS.], [HI-SPEED BURST], [PHOTO FRAME]
(Setting is restored to [AWB] when scene is changed.)
- The types of flash available (→37) vary according to the scene. The Scene Mode flash setting is reset to the default setting when the Scene Mode is changed.
- Guidelines displayed in grey in [NIGHT PORTRAIT], [NIGHT SCENERY], [STARRY SKY], and [FIREWORKS] Scene Modes.

Using flash in Scene Modes. (→37)

■ Changing the selected Scene Mode

- ① Touch on the recording screen
- ② From the scene menu, touch a scene

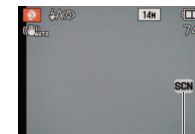

Touch to change the scene

Scene	Uses, Tips	Notes
[PORTRAIT]	<p>Improves the skin tone of subjects for a healthier appearance in bright daylight conditions.</p> <p>Tips</p> <ul style="list-style-type: none"> • Stand as close as possible to subject. • Zoom: As telescopic as possible (T side) 	<ul style="list-style-type: none"> • [AF MODE] default setting is (Face Detection).
[SOFT SKIN]	<p>Smooths skin colours in bright, outdoor daylight conditions (portraits from chest upwards).</p> <p>Tips</p> <ul style="list-style-type: none"> • Stand as close as possible to subject. • Zoom: As telescopic as possible (T side) 	<ul style="list-style-type: none"> • Clarity of effect may vary depending on brightness. • [AF MODE] default setting is (Face Detection). • If a part of the background etc. is a colour close to skin colour, this part is also smoothed.
[TRANSFORM]	<p>Changes the subject to a slim-looking or glamorous appearance.</p> <p>① Touch a transform effect. The settings can also be changed in the Quick menu.</p> <div style="display: flex; align-items: center; justify-content: center;"> <div style="border: 1px solid black; padding: 5px; margin-right: 10px;"> <small>TRANSFORM</small> <small>SLIM</small> <small>NO EFFECT</small> <small>STRETCH</small> <small>CANCEL</small> </div> <div style="text-align: center;"> <small>[SLIM]</small> <small>↑</small> <small>[NO EFFECT]</small> <small>↓</small> <small>[STRETCH]</small> </div> </div> <p>② Take the picture.</p> <p>Notes</p> <ul style="list-style-type: none"> • This function can be used for personal use only, and is not to be used for unauthorized commercial purposes or commercial gain, which would represent a copyright issue. • Do not use in ways that violate public order and decency or defame or slander others. • Do not use in ways that harm the subject. 	<ul style="list-style-type: none"> • When taking a picture, a process is performed that improves the skin appearance. • The picture quality becomes slightly lower. • [PICTURE SIZE] is fixed as follows. <small>4:3</small> : 3 M <small>3:2</small> : 2.5 M <small>16:9</small> : 2 M • [AF MODE] default setting is (Face Detection). • The following functions cannot be used: Extra Optical Zoom/[DIGITAL ZOOM]/[BURST]











Taking pictures according to the scene







[SCENE MODE] (Continued)

Recording Mode: MS SCN

How to select a scene. (→42)

Using flash in Scene Modes. (→37)

Scene	Uses, Tips	Notes
 [SELF PORTRAIT]	Take pictures of yourself.  Tips <ul style="list-style-type: none"> Press shutter button halfway → self-timer indicator illuminates → press shutter button fully → review (if self-timer indicator flashes, focus is not correctly aligned) Focus: 30 cm - 1.2 m (0.99 - 3.94 feet) (Max. W) Do not use zoom (harder to focus). (Zoom moved to max. W automatically) 2-second self-timer recommended. 	<ul style="list-style-type: none"> Main fixed settings: [STABILIZER]: [MODE 2] [AF ASSIST LAMP]: [OFF] [SELFTIMER]: [OFF]/[2SEC.] [AF MODE] default setting is  (Face Detection).
 [SCENERY]	Takes clear pictures of wide, distant subjects. Tips <ul style="list-style-type: none"> Stand at least 5 m (16.4 feet) away. 	<ul style="list-style-type: none"> Main fixed settings: [FLASH]:  [FORCED FLASH OFF] [AF ASSIST LAMP]: [OFF]
 [SPORTS]	Takes pictures of scenes with fast movement, e.g. sports. Tips <ul style="list-style-type: none"> Stand at least 5 m (16.4 feet) away. 	<ul style="list-style-type: none"> When the camera is set to [STABILIZER] and there is very little jitter, or if [STABILIZER] is set to [OFF], shutter speed may slow down up to 1 second. Main fixed setting: [SENSITIVITY]: [ ISO] (Automatically set in a range up to 1600)
 [NIGHT PORTRAIT]	Takes pictures of people and nightscapes with close to actual brightness. Tips <ul style="list-style-type: none"> Use flash. Subject should not move. Tripod, self-timer recommended. Stand at least 1.5 m (4.92 feet) away at the Wide end (wide-angle) Focus: Max. W: 80 cm - 5 m (2.62 feet - 16.4 feet) Max. T: 1.2 m - 5 m (3.94 feet - 16.4 feet) 	<ul style="list-style-type: none"> When the camera is set to [STABILIZER] and there is very little jitter, or if [STABILIZER] is set to [OFF], shutter speed may slow down up to 1 second (or up to 8 seconds if flash is set to  (Forced Flash Off)). Interference may be noticeable with dark scenes. Shutter may remain closed for 8 seconds after taking picture. [AF MODE] default setting is  (Face Detection).

Scene	Uses, Tips	Notes
 [NIGHT SCENERY]	Takes clear pictures of night scenes. Tips <ul style="list-style-type: none"> Stand at least 5 m (16.4 feet) away. Tripod, self-timer recommended. 	<ul style="list-style-type: none"> When the camera is set to [STABILIZER] and there is very little jitter, or if [STABILIZER] is set to [OFF], shutter speed may slow down up to 8 seconds. Interference may be noticeable with dark scenes. Shutter may remain closed for up to 8 seconds after taking picture. Main fixed settings: [FLASH]:  [FORCED FLASH OFF] [AF ASSIST LAMP]: [OFF] [SENSITIVITY]: ISO80 - 800
 [FOOD]	Takes natural-looking pictures of food. Tips <ul style="list-style-type: none"> Focus: Max. W: 10 cm (0.33 feet) and above Max. T: 50 cm (1.64 feet) and above 	-
 [PARTY]	Brighten subjects and background in pictures of indoor events, such as weddings. Tips <ul style="list-style-type: none"> Stand approx. 1.5 m (4.92 feet) away. Zoom: Wide (W side) Use flash. Tripod, self-timer recommended. 	<ul style="list-style-type: none"> [AF MODE] default setting is  (Face Detection).
 [CANDLE LIGHT]	Brings out the atmosphere of a candlelit room. Tips <ul style="list-style-type: none"> Focus: Max. W: 10 cm (0.33 feet) and above Max. T: 50 cm (1.64 feet) and above Do not use flash. Tripod, self-timer recommended. (Shutter speed: max. 1 sec.) 	<ul style="list-style-type: none"> When the camera is set to [STABILIZER] and there is very little jitter, or if [STABILIZER] is set to [OFF], shutter speed may slow down up to 1 second. [AF MODE] default setting is  (Face Detection).





Taking pictures according to the scene



[SCENE MODE] (Continued)

Recording Mode: MS SCN

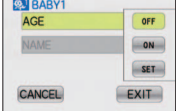
How to select a scene (→42)

Using flash in Scene Modes (→37)

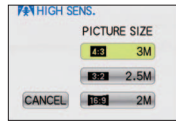
Scene	Uses, Tips	Notes
  [BABY]	<p>Uses weak flash to bring out skin colours.</p> <ul style="list-style-type: none"> To record age and name ([BABY1] and [BABY2] can be set separately.)  <p>① Touch [SET] for [AGE] or [NAME]. ② Set the birthday and name. Age: Touch ▲▼ on the screen to set birth date and touch [SET]. Name: (See 'Entering Text' (→63)) ③ Touch [EXIT] to close.</p> <p>Tips</p> <ul style="list-style-type: none"> Make sure [AGE] and [NAME] are [ON] before taking a picture. To reset: Select [RESET] from [SETUP] menu. Focus: Max. W: 10 cm (0.33 feet) and above Max. T: 50 cm (1.64 feet) and above 	<ul style="list-style-type: none"> Age and name will be displayed for approx. 5 seconds after setting this mode. When the camera is set to [STABILIZER] and there is very little jitter, or if [STABILIZER] is set to [OFF], shutter speed may slow down up to 1 second. Age display format depends on [LANGUAGE] setting. [AGE] and [NAME] print setting can be made on your computer using the supplied CD-ROM 'PHOTOfunSTUDIO'. Text may also be stamped onto the still picture using [TEXT STAMP] (→70). Date of birth will be displayed as [0 month 0 day]. Main fixed setting: [SENSITIVITY]: [ISO] (Automatically set in a range up to 1600) [AF MODE] default setting is [Face Detection].
 [PET]	<p>Records pet's age and name when taking pictures.</p> <p>Tips</p> <ul style="list-style-type: none"> Same as for [BABY] 	<ul style="list-style-type: none"> When the camera is set to [STABILIZER] and there is very little jitter, or if [STABILIZER] is set to [OFF], shutter speed may slow down up to 1 second. Default settings are as follows. [AF MODE]: [1-area-focusing] [AF ASSIST LAMP]: [OFF] Refer to [BABY] for other notes and fixed functions.
 [SUNSET]	<p>Takes clear pictures of scenes such as sunsets.</p>	<ul style="list-style-type: none"> Main fixed settings: [SENSITIVITY]: ISO80 [FLASH]: [FORCED FLASH OFF] [AF ASSIST LAMP]: [OFF]

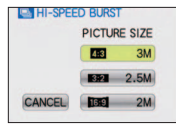
Scene	Uses, Tips	Notes								
 [HIGH SENS.]	<p>Prevents blurring of subject in dark, indoor conditions.</p> <p>Touch a number of recording pixels (aspect ratio).</p>  <p>Tips</p> <ul style="list-style-type: none"> Focus: Max. W: 10 cm (0.33 feet) and above Max. T: 50 cm (1.64 feet) and above 	<ul style="list-style-type: none"> Pictures may appear slightly grainy due to high sensitivity. Main fixed setting [SENSITIVITY]: ISO1600 - 6400 The following functions cannot be used: Extra Optical Zoom/[DIGITAL ZOOM] 								
 [HI-SPEED BURST]	<p>Takes pictures of rapid movement or a decisive moment.</p> <p>① Touch a number of recording pixels (aspect ratio).</p>  <p>② Take pictures. (Hold shutter button) Still pictures are taken continuously while the shutter button is pressed fully.</p> <table border="1" data-bbox="1149 843 1535 974"> <tr> <td>Maximum speed*</td> <td colspan="2">Approx. 4.6 pictures/sec</td> </tr> <tr> <td rowspan="2">Number of recordable pictures*</td> <td>Built-in memory</td> <td>Approx. 15 or more</td> </tr> <tr> <td>Card</td> <td>Approx. 15 to 100 (The maximum is 100)</td> </tr> </table> <p>* The burst speed and number of recordable pictures change according to the recording conditions or types of cards.</p> <p>Tips</p> <ul style="list-style-type: none"> Focus: Max. W: 10 cm (0.33 feet) and above Max. T: 50 cm (1.64 feet) and above 	Maximum speed*	Approx. 4.6 pictures/sec		Number of recordable pictures*	Built-in memory	Approx. 15 or more	Card	Approx. 15 to 100 (The maximum is 100)	<ul style="list-style-type: none"> The number of burst recording pictures increases immediately after formatting. The picture quality becomes slightly lower. Main fixed settings: [FLASH]: [FORCED FLASH OFF] [SENSITIVITY]: ISO500 - 800 The focus, zoom, exposure, White Balance, shutter speed and ISO Sensitivity are fixed to the settings for the first picture. The following functions cannot be used: Extra Optical Zoom/[DIGITAL ZOOM]/[SELFTIMER]/[BURST] If recording is repeated, depending on the usage conditions, there may be a delay before the camera takes pictures again.
Maximum speed*	Approx. 4.6 pictures/sec									
Number of recordable pictures*	Built-in memory	Approx. 15 or more								
	Card	Approx. 15 to 100 (The maximum is 100)								



Taking pictures according to the scene





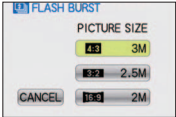

[SCENE MODE] (Continued)

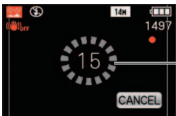
Recording Mode: MS SCN

How to select a scene (→42)

Using flash in Scene Modes (→37)

Scene	Uses, Tips	Notes
 <p>[FLASH BURST]</p>	<p>Enables continuous recording in dim locations.</p> <p>① Touch a number of recording pixels (aspect ratio).</p>  <p>② Take pictures (Hold shutter button). Still pictures are taken continuously while the shutter button is held down. Number of continuous shots: Max. 5</p> <p>Tips</p> <ul style="list-style-type: none"> Use within the effective range of the flash. (→37) Focus: Max. W: 10 cm (0.33 feet) and above Max. T: 50 cm (1.64 feet) and above 	<ul style="list-style-type: none"> The picture quality becomes slightly lower. Main fixed settings: [FLASH]: [FORCED FLASH ON] [SENSITIVITY]: [ISO] (Automatically set in a range up to 3200) The focus, zoom, exposure compensation, shutter speed, and ISO Sensitivity are all fixed at the setting for the first picture. The shutter speed becomes 1/30th of a second to 1/1600th of a second. The following functions cannot be used: Extra Optical Zoom/[DIGITAL ZOOM]/[BURST] For details about flash (→36)
 <p>[STARRY SKY]</p>	<p>Takes clear pictures of starry skies or dark subjects.</p> <ul style="list-style-type: none"> Shutter speed settings ① Touch a shutter speed (seconds).  <ul style="list-style-type: none"> The number of seconds can be changed with Quick menu. (→17) <p>② Press shutter button.</p>  <p>Countdown begins</p> <p>Tips</p> <ul style="list-style-type: none"> Set longer shutter speeds for darker conditions. Always use a tripod. Self-timer recommended. Do not move the camera until the countdown (above) has ended. (Countdown for processing is redisplayed afterwards) 	<ul style="list-style-type: none"> Main fixed settings: [FLASH]: [FORCED FLASH OFF] [STABILIZER]: [OFF] [SENSITIVITY]: ISO80 The following functions cannot be used: [BURST]/[EXPOSURE]

Scene	Uses, Tips	Notes
 <p>[FIREWORKS]</p>	<p>Takes clear pictures of fireworks in the night sky.</p> <p>Tips</p> <ul style="list-style-type: none"> Stand at least 10 m (32.8 feet) away. Tripod recommended. 	<ul style="list-style-type: none"> Shutter speed can be set to 1/4 second or 2 seconds (if there is a little jitter or if Optical Image Stabilizer is [OFF]). (when not using exposure compensation) Main fixed settings: [FLASH]: [FORCED FLASH OFF] [SENSITIVITY]: ISO80 [AF ASSIST LAMP]: [OFF]
 <p>[BEACH]</p>	<p>Brings out the clear blues of the sky and the sea without darkening subject.</p>	<ul style="list-style-type: none"> [AF MODE] default setting is (Face Detection). Do not touch camera with wet hands. Beware of sand and sea water.
 <p>[SNOW]</p>	<p>Brings out the natural colour of snow in ski slope and mountain scenes.</p>	<ul style="list-style-type: none"> Battery life is reduced in lower air temperatures.
 <p>[AERIAL PHOTO]</p>	<p>Takes pictures of the view from aircraft windows.</p> <p>Tips</p> <ul style="list-style-type: none"> Angle the camera towards areas of contrasting colours when aligning the focus. Check that the interior of the aircraft is not reflected in the window. Stand at least 5 m (16.4 feet) away. 	<ul style="list-style-type: none"> Main fixed settings: [FLASH]: [FORCED FLASH OFF] [AF ASSIST LAMP]: [OFF] Turn the camera off when taking off or landing. When using the camera, follow all instructions from the cabin crew.
 <p>[FILM GRAIN]</p>	<p>Produces black and white pictures with a grainy texture.</p> <p>Tips</p> <ul style="list-style-type: none"> Focus: Max. W: 10 cm (0.33 feet) and above Max. T: 50 cm (1.64 feet) and above 	<ul style="list-style-type: none"> Main fixed setting: [SENSITIVITY]: ISO1600 The following functions cannot be used: [DIGITAL ZOOM]/[BURST]
 <p>[PHOTO FRAME]</p>	<p>A frame is superimposed over the still pictures.</p> <p>Touch a frame.</p> 	<ul style="list-style-type: none"> The recording pixel level is 2 M (4:3). Main fixed setting: [AUTO REVIEW]: [2 SEC.] The colour of the frame displayed on the screen and the colour of the frame around the actual still picture may differ, but this is not a malfunction. Guide lines cannot be displayed. The following functions are not available: Extra Optical Zoom/[DIGITAL ZOOM]/[BURST]

Registering commonly used scenes

[MY SCENE MODE]

Recording Mode: MS

You can register a commonly used Scene Mode in MS. After you register it, simply switch to [MY SCENE MODE] and you can record in the registered Scene Mode.

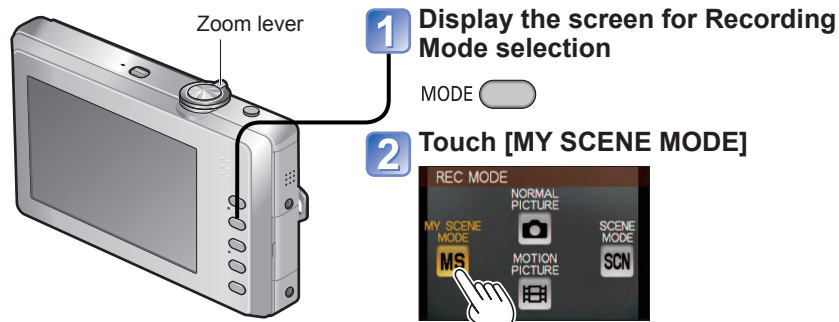

- If you have already registered in My Scene Mode, it is displayed as a registered scene.

3 Touch a scene

The selected Scene Mode is registered under [MY SCENE MODE] and the recording screen displays.

- Touch ▲▼ on the screen to change the page. Zoom lever can also be used to switch to next screen.
- Touch [EXIT] to return to the original screen.

■ Taking pictures in registered Scene Mode

- 1 Press the [MODE] button
- 2 Touch [MY SCENE MODE]

■ Changing registered Scene Mode

- 1 Press the [MODE] button
- 2 Touch [MY SCENE MODE]
- 3 Touch SCN
- 4 From the scene menu, touch a scene

- For details on the preset scene, see the pages on Scene Mode. (→42)
- If recording settings are reset by [RESET] in the [SETUP] menu, the preset Scene Mode is cleared.

Taking motion pictures

[MOTION PICTURE] Mode

Recording Mode:

Record motion pictures with audio as follows. (Note that recording without audio is not possible.)

Microphone
(Do not cover with your finger)

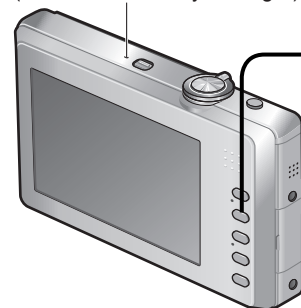

Remaining recording time (approx.)



Elapsed recording time (approx.)

■ Playing back motion pictures (→65)

1 Display the screen for Recording Mode selection

MODE

2 Touch [MOTION PICTURE] Mode

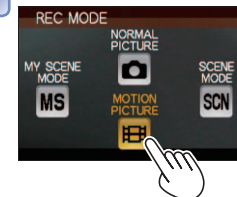

3 Start recording



Press halfway
(adjust the focus)

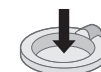

Press fully
(start recording)

- The focus and zoom will remain as they were at the beginning of recording.

4 End recording



Press fully

- For information on the available recording time (→96).
- Depending on the type of card used, a card-access display may appear for a while after motion picture recording. This does not indicate a problem.
- Immediately release the shutter button after pressing it all the way.
- The following functions are not available:
 - Extra Optical Zoom and [ROTATE DISP.] for still pictures taken vertically.
- In [AF MODE], (9-area-focusing) is fixed.
- In [STABILIZER], [MODE 1] is fixed.
- When there is no space left to store the motion picture, recording automatically ends. Additionally, recording in progress may be stopped, depending on the card used.

Taking motion pictures

[MOTION PICTURE] Mode (Continued)

Recording Mode:

[REC QUALITY]

When recording motion picture, use a card rated with an SD speed class* of 'Class 6' or higher.

* SD speed class refers to a specification for sustained write speeds.

1 Press the [MENU] button to display the menu screen

2 Touch [REC QUALITY]

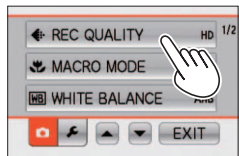

3 Touch a picture quality

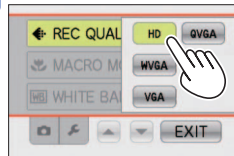

4 Touch [EXIT]

Picture Quality	Picture Size	No. of Frames	Picture Aspect Ratio
[HD]	1280 × 720 pixels	30 fps	16:9
[WVGA]	848 × 480 pixels		
[VGA]	640 × 480 pixels		
[QVGA]*	320 × 240 pixels		4:3

* [QVGA] is fixed when recording to built-in memory.

- Depending on the motion picture recording environment, static electricity or electromagnetic waves may cause the screen to go black momentarily or noise to be recorded.
- Before recording motion pictures, make sure the battery is adequately charged, or use an AC adaptor (optional).
- When recording motion pictures using an AC adaptor, if you unplug the AC adaptor or a power outage occurs, power to the camera is cut, and the motion picture in progress is no longer recorded.
- If you attempt to play motion pictures recorded with the camera on other devices, playback may not be possible, or the picture or sound quality may be poor. Additionally, incorrect recording information may be indicated.
- Motion pictures recorded with the camera cannot be played on Panasonic LUMIX digital cameras sold before July 2008. (However, motion pictures recorded with LUMIX digital cameras sold before this date can be played on this camera.)

Useful features for travel

Recording Mode: * * Recording only. (Cannot set.)

[TRAVEL DATE] (Record travel date and destination)

Record information as to what day and where pictures were taken by setting departure dates and destinations.

Set-up: • Clock must be set in advance (→13).

• Press [MENU] → [SETUP] menu → Touch [TRAVEL DATE]

1 Touch [TRAVEL SETUP]

2 Touch [SET]

3 Touch ▲▼ on the screen and set the departure date

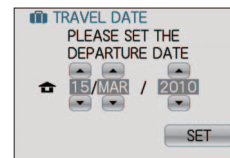

4 Touch [SET]

5 Similarly set the return date and touch [SET]

6 Touch [LOCATION]

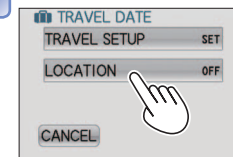

7 Touch [SET]

8 Enter destination
• 'Entering Text' (→63)

9 Touch [CANCEL]

10 Touch [EXIT]

■ To cancel

When the return date has passed, the setting is automatically cancelled.

- To cancel in the interim
 - ① Touch [OFF] in step **2**
 - ② Touch [CANCEL]
 - ③ Touch [EXIT]

Useful features for travel (Continued)

Recording Mode: * * Recording only. (Cannot set.)

- The number of days elapsed is displayed for approx. 5 sec. when switching from Playback to Recording Mode or when power is turned on. (displayed at bottom-right of screen)
- When destination is set in [WORLD TIME] (→54), days elapsed are calculated based on local destination time.
- If settings are made before departure date, number of days to departure are displayed in orange with a minus sign (but not recorded).
- When [TRAVEL DATE] is displayed in white with a minus sign, the [HOME] date is one day in advance of the [DESTINATION] date (this is recorded).
- To print travel date or destination → Use [TEXT STAMP], or print using supplied CD-ROM 'PHOTOfunSTUDIO'.
- [TRAVEL SETUP] can be recorded during motion picture recording, but [LOCATION] cannot.

[WORLD TIME] (Registering local time at your travel destination)

Set-up: • Clock must be set in advance (→13).

• Press [MENU] → [SETUP] menu → Touch [WORLD TIME]

[PLEASE SET THE HOME AREA] will be displayed when setting for the first time. In this case, touch [SET] and skip to step 2.

■ Set home area

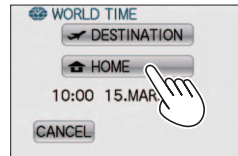

City/area name



Current time

Difference with GMT
(Greenwich Mean Time)

Touch to set / cancel summer time

1 Touch [HOME]

2 Touch ◀▶ to set your home area

3 Touch [SET]

- Screen from step 1 will be displayed only when camera is used for the first time (or has been reset).

■ Set destination area

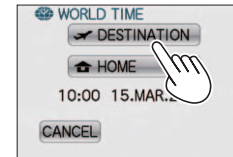

City/area name

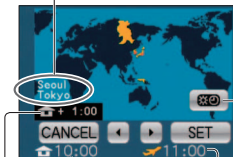

Current time

Current time at selected destination

Difference with home time

Touch to set / cancel summer time

1 Touch [DESTINATION]

2 Touch ◀▶ to set city or area

- If actual destination is unavailable, select based on 'difference with home time'.

3 Touch [SET]

■ Upon your return

Perform steps 1, 2 and 3 (→54) and return clock to home

- When summer time is set in [DESTINATION], the current time is advanced by 1 hour. If the setting is cancelled, the time automatically returns to the current time. Even if you set summer time in [HOME], current time will not be changed. Please advance the current time by 1 hour in [CLOCK SET] (→13).
- Still pictures and motion pictures recorded after you have specified the destination are labeled (destination) during playback.

Using the [REC] menu

For details about the setting procedure in the [REC] menu (→15)

For details about the setting procedure in the [REC] menu (→15)

'Quick menu' (→17) is useful to easily call up frequently-used menus.

⚡ [FLASH]

For details about the setting (→36)

🕒 [SELFTIMER]

For details about the setting (→35)

🖼️ [PICTURE SIZE]

Set size of picture. This setting determines how many pictures you can record.

■ **Mode:** **[A]** **[MS SCN]**

■ **Settings:**

Recording pixel level type		
4:3	14 M	4320 × 3240
4:3	10 M [EZ]*1	3648 × 2736
4:3	5 M [EZ]	2560 × 1920
4:3	3 M [EZ]*1	2048 × 1536
4:3	0.3 M [EZ]	640 × 480
3:2	12.5 M	4320 × 2880
16:9	10.5 M	4320 × 2432

Recording picture capacity (→96)

*1 This setting is not available in **[A]** ([INTELLIGENT AUTO] Mode).

■ **When the description is ON (📄)**

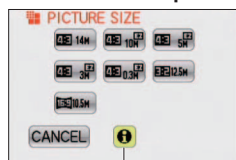

Touch to turn description ON/OFF

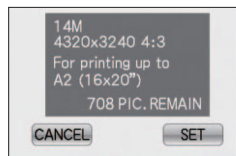

When a recording pixel level is touched, the description for it is displayed.

When [SET] is touched, the recording pixel level with the displayed description is set.

- Reselect a recording pixel level
→ Touch [CANCEL]

- **4:3** **3:2** **16:9** represent the aspect ratios of the still pictures.
- Extra Optical Zoom can be used for picture sizes indicated with **[EZ]**.
- Extra Optical Zoom is not available during motion picture recording, when using [MACRO ZOOM], or in the Scene Modes [TRANSFORM], [HIGH SENS.], [HI-SPEED BURST], [FLASH BURST], or [PHOTO FRAME].
- Mosaic effect may appear depending on subject and recording conditions.

Setting guide

Larger picture size	↔	Smaller picture size*2
Sharper picture		Coarser picture
Lower recording capacity		Higher recording capacity

*2 For example, '0.3 M **[EZ]**' is suitable for e-mail attachments or longer recording.

[ISO] [SENSITIVITY]

Set ISO Sensitivity (sensitivity to lighting) manually.

We recommend higher settings to take clear pictures in darker locations.

■ **Mode:** **[S]**

■ **Settings:** **[F ISO]** (Intelligent ISO) / **[80]** / **[100]** / **[200]** / **[400]** / **[800]** / **[1600]**

Setting guide

[SENSITIVITY]	↔	[1600]
Location (recommended)		Bright (outdoors) / Dark
Shutter speed		Slow / Fast
Interference		Low / High

- **[F ISO]** is automatically set in a range up to 1600 based on subject movement and brightness.
- Scope of flash recording (→37)
- If interference becomes noticeable, we recommend reducing the setting, or selecting [NATURAL] in the [COLOR MODE].



Using the [REC] menu (Continued)

[AF MODE]

Method of aligning focus can be changed according to position and number of subjects.

■ **Mode:** MS SCN

■ **Settings:** / /

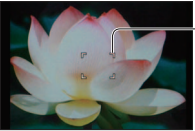
<p>Taking front-on pictures of people</p> <p> (Face Detection)</p>	<p>Recognises faces (up to 15 people) and adjusts exposure and focus accordingly.</p> <p>AF area Yellow : When the shutter button is pressed halfway, the frame turns green when the camera is focused. White : Displayed when more than one face is detected. Other faces that are the same distance away as faces within the yellow AF area are also focused.</p> 
<p>Subject not centred in picture (AF area not displayed until focused)</p> <p> (9-area-focusing)</p>	<p>Automatically focuses on any of 9 points.</p> <p>AF area</p> 
<p>Determined position for focus</p> <p> (1-area-focusing)</p>	<p>Focuses on AF area in centre of picture. (Recommended when focus is difficult to align)</p> <p>AF area</p> 

- AF area becomes larger in dark locations or when using Digital Zoom or Macro Zoom, etc.
- Cannot set to 'Face Detection' in the following cases: [NIGHT SCENERY], [FOOD], [STARRY SKY], [FIREWORKS], [AERIAL PHOTO] Scene Modes
- If the camera misinterprets a non-human subject as a face in the 'Face Detection' setting, switch to another setting.
- The Face Detection function may fail to work under the following conditions: (AF Mode setting is switched to)
 - When the face is not facing the camera or the face is at an angle
 - When the facial features are hidden behind sunglasses, etc.
 - When there is little face shadow
 - When the face is extremely bright or dark
 - When the face appears small on the screen
 - When there is rapid movement
 - When the camera is shaking
 - When the subject is other than a human being such as pets
 - When Digital Zoom is used

For details about the setting procedure in the [REC] menu. (→15)

[MACRO MODE]

For details about the setting. (→38)

[WB] [WHITE BALANCE]

Adjust colouring to suit light source if colours otherwise appear unnatural.

■ **Mode:** MS SCN

■ **Settings:** [AWB] (automatic) / (outdoor, clear sky) / (outdoor, cloudy sky) / (outdoor, shade) / (incandescent lighting) / (uses value set in SET) / SET (set manually)

[AWB] operational range:

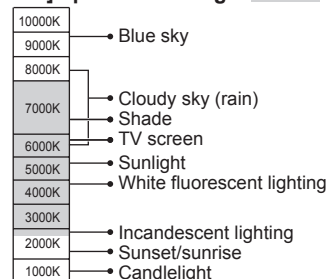

- Picture may appear red or blue if out of range. This function may also not work correctly even within range if there are many light sources present.
- We recommend setting to [AWB] or SET when under fluorescent lighting.

■ **Setting White Balance manually** (SET)



Only takes picture of white objects within frame

- The White Balance you set is retained even after the power is turned off.
- It may not be possible to set the correct White Balance if subjects are too bright or too dark. In this case, adjust the brightness and try to set the White Balance again.

Using the [REC] menu (Continued)

For details about the setting procedure in the [REC] menu. (→15)

[EXPOSURE]

For details about the setting. (→41)

[BURST]

Enables a rapid succession of still pictures to be taken. Succession of still pictures taken while shutter button is held down.

■ **Mode:**   MS SCN

■ **Settings:** [OFF]/

Speed*	No. of pictures
Approx. 1.5 pictures/sec	Until card/built-in memory is full

* Recording becomes progressively slower. (The onset of delay varies depending on the type of card and the recording pixel level.)

- Focus is fixed from first picture. Exposure and White Balance is adjusted for each picture.
- When using self-timer: Fixed at 3 pictures.
- Burst speed may be reduced if ISO Sensitivity is set to high, or if shutter speed is reduced in darker locations.
- When burst is selected, the flash is disabled.
- When burst is performed with the built-in memory, data writing takes some time.
- Settings will be stored even if power is turned off.
- When you record subjects in motion where there is a significant difference between light and dark areas, it may not be possible to achieve the optimal exposure.
- Auto review performed regardless of [AUTO REVIEW] setting.
- Burst is not available in the Scene Modes [TRANSFORM], [HI-SPEED BURST], [FLASH BURST], [STARRY SKY], [FILM GRAIN], and [PHOTO FRAME].
- Using the [HI-SPEED BURST] Scene Mode allows a faster succession of still pictures to be taken. [FLASH BURST] is convenient to take continuous pictures using flash in dark places.

[DIGITAL ZOOM]

Multiplies effect of Optical Zoom or Extra Optical Zoom by up to 4 times. (For details (→30))

■ **Mode:**  MS SCN

■ **Settings:** [OFF]/[ON]

- This is fixed at [ON] when [MACRO ZOOM] is set.
- Not available in Motion Picture Recording Mode. The setting in other Recording Mode is applied.

[COLOR MODE]

Set colour effects.

■ **Mode:**   

■ **Settings:** [STANDARD] / [NATURAL] (soft) / [VIVID] (sharp) / [B/W] / [SEPIA] / [COOL] (more blue) / [WARM] (more red)





- If interference is noticeable in dark locations: Set to [NATURAL].
- In  ([INTELLIGENT AUTO] Mode), [STANDARD], [B/W], and [SEPIA] can only be set.

[STABILIZER]

Automatically detects and prevents jitter.

■ **Mode:**  MS SCN

■ **Settings:**

Settings	Effect
 [OFF]	Pictures deliberately taken with no jitter correction
 [AUTO]	The Optimum Image Stabilizer is performed automatically based on the recording conditions
 1 [MODE 1]	Constant correction (Monitor image stable, composition easy to determine)
 2 [MODE 2]	Correction when shutter button is pressed (More effective than [MODE 1])

- Setting fixed to [MODE 2] in [SELF PORTRAIT] and [OFF] in [STARRY SKY] Scene Modes.
- Cases where Optical Image Stabilizer may be ineffective:
Heavy jitter, high zoom ratio (including Digital Zoom range), fast-moving objects, indoors or in dark locations (due to low shutter speed)
- This is fixed at [MODE 1] during motion picture recording.

Using the [REC] menu (Continued)

For details about the setting procedure in the [REC] menu. (→15)

AF* [AF ASSIST LAMP]

Illuminates lamp when dark to facilitate focus alignment.

■ **Mode:** MS SCN

■ **Settings:** [OFF]: Lamp off (taking pictures of animals in dark, etc.)
[ON]: Lamp illuminated with halfway press of shutter button (AF* and larger AF area displayed)

● Cannot be set in Motion Picture Recording Mode. The setting in other Recording Mode is applied.



Lamp: Effective distance: 1.5 m (4.92 feet)
(Do not cover or look at lamp from close range)

[RED-EYE REMOVAL]

Automatically detects red-eye and corrects still picture data when recording with flash red-eye reduction ().

■ **Mode:** MS SCN

■ **Settings:** [OFF]/[ON]

- Disabled when [AF MODE] is other than (Face Detection).
- Compensation may not be possible, depending on red-eye conditions.
- When [ON] is selected, is displayed in the flash icon. (→36)

[CLOCK SET]

Set the clock. Same function as that in [SETUP] menu (→13).

Entering Text

When registering names in scene modes [BABY] and [PET] or [LOCATION] names in [TRAVEL DATE], use the following procedure to enter text.

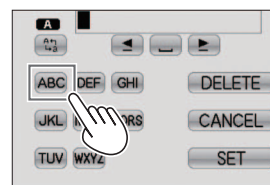
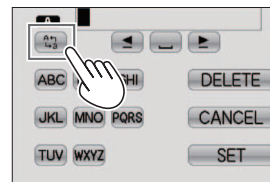

1 (On the setting screen of each menu)
Touch to select the type of characters

: Upper/lower case alphabet
 : Symbols/numbers

2 Touch the character icon to input

- Text is inserted at the cursor position.
- To enter a character, touch the character icon repeatedly until the desired character is displayed.
- If the characters you are going to input next are under the same character icon, touch and move the cursor.
- Touch to insert a space between words.

■ **To correct input characters**

- ① Touch and move cursor to the place you wish to correct
- ② Touch [DELETE]
- ③ Enter the correct characters

3 Touch [SET]

- : A maximum of 30 characters can be entered.
- The entry position cursor can be moved left and right with the zoom lever.
- Touch [CANCEL] to return to the menu screen.
- Text is scrolled if it does not fit on the screen.
- To print the text you have specified, use [TEXT STAMP] (→70) or use the 'PHOTOfunSTUDIO' software on the CD-ROM (supplied).

Viewing as list (Multi Playback/Calendar Playback)

Playback Mode:

You can view 9 (or 18) pictures at once (Multi Playback), or view all pictures taken on a certain date (Calendar Playback).

1 Press the Playback button

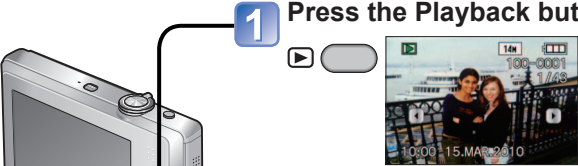

2 Set to multiple screen display

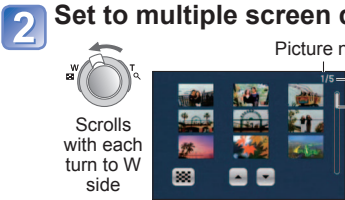

Scrolls with each turn to W side

Picture no. Total no. Scroll bar

- Touch ▲▼ on the screen to change the page.
- Touch to go to 9-screen display.
- Touch to go to 18-screen display.
- Touch to go to the calendar screen.

(9 screens)

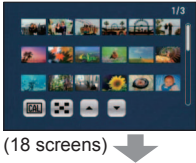

(18 screens)

Selected date (First picture from date)



(Calendar screen)

- Touch ▲▼ on the screen to select the week and touch ◀▶ to select the day, and touch [SET] to display that day's pictures in 9-screen display.

■ To restore

Turn to T side

■ To change from 9/18-screen display to single-screen display

Touch a picture

- Only months when pictures were taken are shown on the calendar screen. Pictures taken without clock settings are displayed with the date 1st January, 2010.
- Cannot be displayed rotated.
- Pictures displayed with [!] cannot be played back.
- Pictures taken with destination settings made in [WORLD TIME] are displayed in the calendar screen using the appropriate date for the destination's time zone.

Watching motion pictures

Playback Mode:

Motion pictures can be played back just as you view still pictures.

1 Press the Playback button

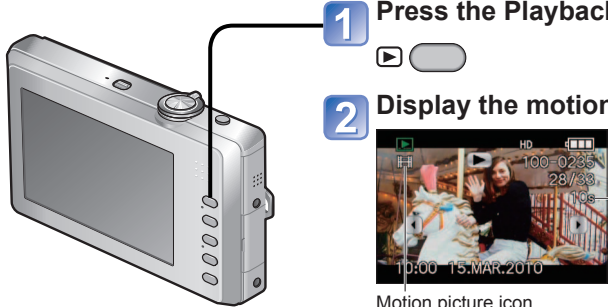

2 Display the motion picture

Motion picture recording time

Motion picture icon

3 Touch

When playback comes to the end, it automatically finishes.

■ Operations during Motion Picture Playback

Touch the screen to display the operations icon.

- If there is no operation for about 2 seconds, the operations icon disappears.

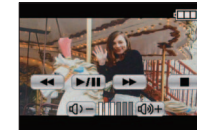

- : Pause/Play
- : Stop
- : Fast rewind (2 steps)/Single-frame rewind (while paused)
- : Fast forward (2 steps)/Single-frame forward (while paused)
- : Volume adjustment (zoom lever can also be used to adjust volume)

- Press during fast rewind or fast forward to return to the normal playback speed.

■ Deleting

(→33)

- Motion pictures recorded on other devices may not be played correctly.
- When using a large-volume memory card, the rewind function may take some time.
- When watching on a computer, use [QuickTime] on the supplied CD-ROM to play motion pictures.

Different playback methods (Playback Mode)

Playback Mode:

Recorded pictures can be played back in a variety of ways.

- 1 Press the Playback button**
- 2 Display the screen for Playback Mode selection**
MODE
- 3 Touch a playback method**

■ **[NORMAL PLAY]**
(→32)

■ **[SLIDE SHOW]**
(→67)

■ **[CATEGORY PLAY]**
(→69)

■ **[MULTI PLAYBACK]**
(→64)

■ **[CALENDAR]**
(→64)

■ **[FAVORITE PLAY]**
(→69)

- When no card is inserted, pictures are played back from the built-in memory.
- After you switch from Recording Mode to Playback Mode, the Playback Mode automatically becomes [NORMAL PLAY].
- [FAVORITE PLAY] is only displayed when pictures have been set as [FAVORITE] and the setting is [ON].

[SLIDE SHOW]

Automatically play still pictures in order and to music. Recommended when viewing on TV screen.

1 Touch a playback method



- **[ALL]** : Playback of all still pictures
- **[CATEGORY SELECTION]** : Touch a category to play
- **[FAVORITE]** : Play still pictures set as [FAVORITE] (displayed only when [FAVORITE] still pictures have been set and setting is [ON]).

2 Set playback effects



- ① Touch [EFFECT]
- ② Touch a playback effect
- ③ Touch [SETUP]
- ④ Change Slide Show settings
- ⑤ Touch [CANCEL]

[EFFECT] (Select music and effects according to picture atmosphere)	
[AUTO]	Camera selects optimum effect from [NATURAL], [SLOW], [SWING], and [URBAN] (only available with [CATEGORY SELECTION] setting)
[NATURAL]	Play with relaxed music and screen transition effects
[SLOW]	
[SWING]	Play with livelier music and screen transition effects
[URBAN]	
[OFF]	No effects

[SETUP]	
[DURATION]	[1 SEC.] / [2 SEC.] / [3 SEC.] / [5 SEC.] (Only available when [EFFECT] is [OFF])
[REPEAT]	[OFF]/[ON] (Repeat)
[MUSIC]	[ON]: The audio portion is played to match effects. [OFF]: The audio portion is not played.

3 Touch [START]

- Touch [CANCEL] to return to the menu screen during Slide Show.

Different playback methods (Playback Mode)

(Continued)

Playback Mode:

Operations during Slide Show

Touch the screen to display the operations icon.

- If there is no operation for about 2 seconds, the operations icon disappears.

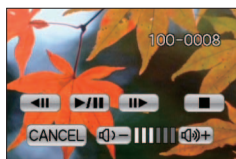

- : Pause/Play
- : Stop
- : (While paused) Previous
- : (While paused) Next
- : Return to settings screen
- : Volume adjustment (zoom lever can also be used to adjust volume)

- When [URBAN] has been selected, the picture may appear in black and white as a screen effect.
- Music effects cannot be added.
- Motion pictures cannot be played back in a Slide Show. When the [MOTION PICTURE] category is selected, the initial screens of motion pictures are used as still pictures for playback in the Slide Show.
- Pictures with different aspect ratios have their edges cut so they can be displayed on the entire screen.

For details about the switching Playback Mode procedure. (→66)

[CATEGORY PLAY]

Pictures can be classified automatically and viewed by category. Automatic classification starts when [CATEGORY PLAY] is selected from the Playback Mode selection menu.

1 Touch a category

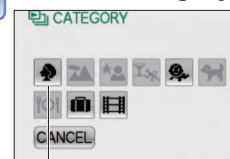

Icons of categories with pictures

2 View pictures

- Calendar display cannot be used.
- The following playback menus only can be set: [ROTATE DISP.], [PRINT SET], [PROTECT]
- To close [CATEGORY PLAY], select [NORMAL PLAY].

[CATEGORY]	Recording information such as Scene Modes
	[PORTRAIT]/ [i PORTRAIT]/ [SOFT SKIN]/ [TRANSFORM]/ [SELF PORTRAIT]/ [NIGHT PORTRAIT]/ [i NIGHT PORTRAIT]/ [BABY]
	[SCENERY]/ [i SCENERY]/ [SUNSET]/ [i SUNSET]/ [AERIAL PHOTO]
	[NIGHT PORTRAIT]/ [i NIGHT PORTRAIT]/ [NIGHT SCENERY]/ [i NIGHT SCENERY]/ [STARRY SKY]
	[SPORTS]/ [PARTY]/ [CANDLE LIGHT]/ [FIREWORKS]/ [BEACH]/ [SNOW]/ [AERIAL PHOTO]
	[BABY]
	[PET]
	[FOOD]
	[TRAVEL DATE]
	[MOTION PICTURE]

★ [FAVORITE PLAY]

Manually play pictures set in [FAVORITE] (displayed only when [FAVORITE] pictures are present and setting is [ON]).

1 View pictures

- Touch on the screen to change the page.

- Calendar display cannot be used.
- The following playback menus only can be set: [ROTATE DISP.], [PRINT SET], [PROTECT]
- To close [FAVORITE PLAY], select [NORMAL PLAY].

Using the [PLAYBACK] menu

Playback Mode:

For details about the setting procedure in the [PLAYBACK] menu (→15)

[TEXT STAMP]

Stamps the recording date or text you have registered in the [BABY] and [PET] Scene Modes or [TRAVEL DATE] on still pictures. Ideal when printing pictures at regular size.

Set-up: Press [MENU] → [PLAYBACK] menu → Touch [TEXT STAMP]

1 Touch [SINGLE] or [MULTI]

2 Select a still picture

● [SINGLE]



- To cancel → Touch [CANCEL]
- To execute → Touch [SET]

● [MULTI] (up to 50 pictures)



- To cancel → Touch [CANCEL]
- To execute → Touch [OK]

3 Touch an item to switch between [ON] and [OFF] and touch [SET]

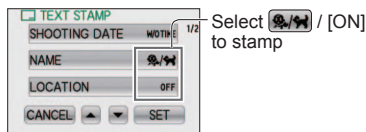

Select / [ON] to stamp

4 Choose whether to stamp the age in years/months



Touch [YES] or [NO]

- This screen is not displayed if you selected [OFF] for [NAME] in step 3.

5 Touch [YES]

(Screen varies according to picture size, etc.)

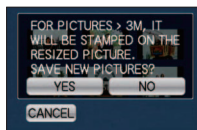

- When you have selected [SINGLE], after step 5, press to return to the menu screen.
- Picture size will be reduced if greater than 3 M. Picture will become slightly grainier.

Picture aspect ratio	After [TEXT STAMP]
4 : 3	3 M
3 : 2	2.5 M
16 : 9	2 M

For details about the setting procedure in the [PLAYBACK] menu (→15)

■ Items that can be stamped

[SHOOTING DATE]	[W/O TIME]: Stamp the recording date [WITH TIME]: Stamp the recording time
[NAME]	Stamp names registered in [BABY] or [PET]
[LOCATION]	Stamp destinations registered in [TRAVEL DATE]
[TRAVEL DATE]	Stamp travel dates registered in [TRAVEL DATE]

- Items you select [OFF] are not stamped.

■ To check stamped text

'Playback zoom' (→32)

- Cannot be used with still pictures taken on other devices, still pictures taken without setting the clock, or motion pictures.
- Still pictures with text stamps cannot be set to [RESIZE], [CROPPING], or restamped, and date-based [PRINT SET] printing cannot be specified.
- Characters may be cut off on certain printers.
- Cannot be set in [CATEGORY PLAY] or [FAVORITE PLAY] Playback Mode.
- **Do not request date printing in store or make date printing on printer for still pictures with date stamps. (Date printing may be overlapping.)**

[RESIZE]

Picture size can be reduced to facilitate e-mail attachment and use in homepages, etc. (Still pictures recorded at the smallest recording pixel level cannot be further reduced.)

Set-up: Press [MENU] → [PLAYBACK] menu → Touch [RESIZE]

■ [SINGLE]

1 Touch [SINGLE]

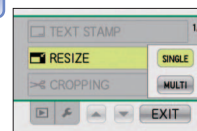

3 Touch the desired size



Current size

Size after change

2 Select a still picture and touch [SET]



4 Touch [YES]

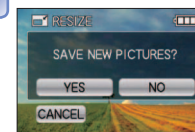

- After confirmation, touch [CANCEL] to return to the menu screen.

- Touch on the screen to change the page.

Using the [PLAYBACK] menu (Continued)

Playback Mode:

For details about the setting procedure in the [PLAYBACK] menu (→15)

■ [MULTI]

1 Touch [MULTI] in step 1 (→71)

2 Select the size after shrinking

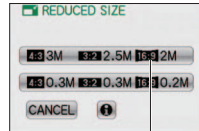

Select number of pixels after resizing

3 Select a still picture and touch [OK] (up to 50 pictures)

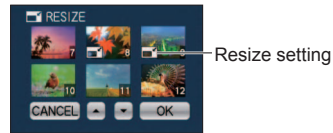

• To cancel → Touch [CANCEL]

4 Touch [YES]

■ When the description is ON ()

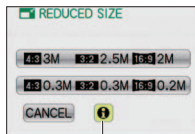

Touch to turn description ON/OFF

When the recording pixel level after resizing is touched, a description is displayed. When [SET] is touched, the recording pixel level with the displayed description is set.

- Reselect a recording pixel level after resizing → Touch [CANCEL]

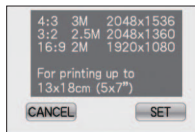

- Picture quality is reduced after resizing.
- Cannot be set in [CATEGORY PLAY] or [FAVORITE PLAY] Playback Mode.
- Motion pictures and text-stamped still pictures cannot be used. May not be compatible with still pictures taken on other devices.

>>> [CROPPING]

Enlarge your still pictures and crop unwanted areas.

Set-up: Press [MENU] → [PLAYBACK] menu → Touch [CROPPING]

1 Use ◀▶ to select a still picture and touch [SET]

2 Expand so that the portion you wish to keep after cropping is displayed



Shrink Enlarge

- You can use ▲▼◀▶ on the screen to move the location displayed.
- Zoom lever can also be used to expand or shrink.

3 Touch [SET]

4 Touch [YES]

- After confirmation, touch [CANCEL] to return to the menu screen.

- Picture quality is reduced after cropping.
- Cannot be set in [CATEGORY PLAY] or [FAVORITE PLAY] Playback Mode.
- Motion pictures and text-stamped still pictures cannot be used. May not be compatible with still pictures taken on other devices.

Using the [PLAYBACK] menu (Continued)

Playback Mode:

[ROTATE DISP.]

Automatically rotate portrait still pictures.

Set-up: Press [MENU] → [PLAYBACK] menu → Touch [ROTATE DISP.]

1 Touch [ON]

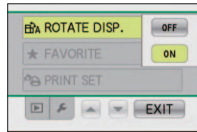

- [ROTATE DISP.] cannot be used with motion pictures.
- Still pictures taken with the lens surface facing directly up or down and still pictures taken on other cameras may not be rotated. Additionally, still pictures taken while holding the camera upside down are not rotated automatically.
- Pictures cannot be rotated during Multi playback and Calendar playback.
- Will only be displayed rotated on computer if in Exif-compatible (→32) environment (OS, software).

★ [FAVORITE]

By labeling your favourite pictures with a star (★), you can enjoy [SLIDE SHOW] or [FAVORITE PLAY] of these pictures only, or you can delete all pictures except your favourites (→33).

Set-up: Press [MENU] → [PLAYBACK] menu → Touch [FAVORITE]

1 Touch [ON]

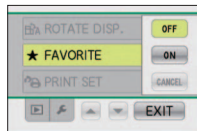

2 Touch [EXIT]

3 (On playback screen) Select a picture and touch ★ (repeat)



Displayed when set (not displayed when [OFF]).

- Up to 999 pictures can be selected.
- To release → Touch again.

■ To clear all

In step 1, touch [CANCEL] → Touch [YES]

- Cannot be set in [FAVORITE PLAY] Playback Mode.
- It may not be possible to set pictures taken with certain other devices as favourites.
- Setting/release can also be made with supplied software 'PHOTOfunSTUDIO'.

For details about the setting procedure in the [PLAYBACK] menu (→15)

[PRINT SET]

Picture/picture no./date printing settings can be made for when printing with DPOF print-compatible shops or printers. (Ask at shop to check compatibility)

Set-up: Press [MENU] → [PLAYBACK] menu → Touch [PRINT SET]

1 Touch [SINGLE] or [MULTI]



2 Select picture

● [SINGLE]



● [MULTI]



3 Set number of pictures by touching ▲▼, and then touch [SET]

(repeat steps 2 and 3 when using [MULTI] (up to 999 pictures))

● [SINGLE]



● [MULTI]



- Date print setting/release → Touch [DATE]
- After confirmation, touch [EXIT] to return to the menu screen.

■ To clear all

In step 1, touch [CANCEL] → Touch [YES]

- When using PictBridge-compatible printers, check settings on actual printer as these may take priority over camera settings.
- To print from built-in memory at a shop, first copy pictures to card (→77) before making settings.
- DPOF print settings may not be made to non-DCF (→32) files.
- Some DPOF information set by other equipment cannot be used. In such cases, delete all of the DPOF information and then set it again with this camera.
- Date printing settings cannot be made for pictures with a [TEXT STAMP] applied. These settings will also be cancelled if a [TEXT STAMP] is applied later.

Using the [PLAYBACK] menu (Continued)

Playback Mode:

[PROTECT]

Set protection to disable picture deletion. Prevents deletion of important pictures.

Set-up: Press [MENU] → [PLAYBACK] menu → Touch [PROTECT]

1 Touch [SINGLE] or [MULTI]

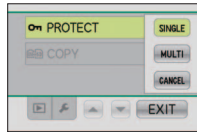

2 Select picture and make setting

- [SINGLE]
Select pictures by touching ◀▶, and then touch [SET]
 - To cancel → Touch [CANCEL]
- [MULTI]
Touch the picture
 - To cancel → Touch again



Picture protected



Picture protected

- After confirmation, touch [EXIT] to return to the menu screen.

■ To clear all

In step 1, touch [CANCEL] → Touch [YES]

■ To cancel while releasing all

Touch [CANCEL]

- May not be effective when using other devices.
- Formatting will cause even protected files to be deleted.
- If the write-protect switch is set to 'LOCK,' pictures cannot be deleted even if they are not protected with the camera setting.

For details about the setting procedure in the [PLAYBACK] menu (→15)

[COPY]

You can copy pictures between built-in memory and memory card.

Set-up: Press [MENU] → [PLAYBACK] menu → Touch [COPY]

1 Select copy method (direction)

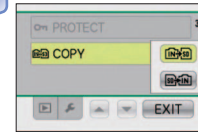

- : Copy all pictures from built-in memory to card (go to step 3)
- : Copy 1 picture at a time from card to built-in memory.

2 When selecting [], select a picture with ◀▶ and touch [SET]

3 Touch [YES]



- To cancel → Touch [CANCEL]
- After confirmation, touch [CANCEL] to return to the menu screen.

(Screen shown is example)

- If there is not enough space on the built-in memory for copying to be performed, turn off the power, remove the card, and delete pictures from the built-in memory.
- Copying of picture data from the built-in memory to memory cards will be terminated midway if there is insufficient space on the card. Using memory cards with higher capacities than the built-in memory (approx. 40 MB) is recommended.
- Copying pictures may take several minutes. Do not turn off power or perform other operations during copying.
- If identical names (folder/file numbers) are present in the copy destination, a new folder for copying will be created when copying from built-in memory to card (). Identically-named files will not be copied from card to built-in memory ().
- Printing and protection settings will not be copied. Set the settings again after copying.
- Only pictures from Panasonic digital cameras (LUMIX) may be copied.
- Original pictures will not be deleted after copying (to delete pictures (→33)).
- This setting can only be made when the Playback Mode is in [NORMAL PLAY].

Using with your PC

Some computers can read directly from the camera's memory card. For details, see the manual for your computer.

Pictures and motion pictures can be imported from the camera to your computer by connecting the two together.

- If your computer does not support SDXC memory cards, a message will be displayed requesting you to format the card. (Do not format the card. This will erase recorded pictures.) If the card is not recognized, refer to the following support website: <http://panasonic.net/avc/sdcard/information/SDXC.html>
- Imported pictures can then be printed or sent by e-mail using the 'PHOTOfunSTUDIO' software on the CD-ROM (supplied).

Getting Ready:

- Use a fully charged battery or connect an AC adaptor (optional).
- When importing pictures from the built-in memory, remove any memory cards.

Check socket direction and insert straight in.
(Damage to socket shape can lead to faulty operation.)

[ACCESS] (sending data)
• Do not disconnect the USB connection cable while [ACCESS] is displayed.

Hold here
(Push until it is fully inserted.)

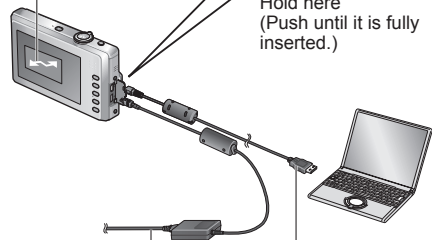

If using AC adaptor, turn off the camera before plugging in or removing.

USB connection cable (always use cable supplied)

1 Turn on power of both camera and computer

2 Connect camera to computer

- Please make sure you use the supplied USB connection cable. Use of cables other than the supplied USB connection cable may cause malfunction.

3 Touch [PC] on the camera

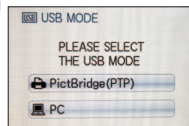

A message may be displayed on screen if [USB MODE] (→21) is set to [PictBridge (PTP)].

4 Operate with your computer

You can save pictures to use on your computer by dragging and dropping folders and files into separate folders on your computer.

Folder and file names on computer

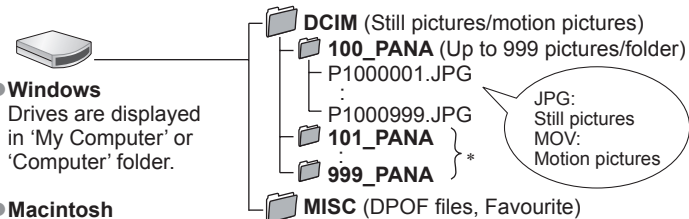

Windows

Drives are displayed in 'My Computer' or 'Computer' folder.

Macintosh

Drives are displayed on the desktop.
(Displayed as 'LUMIX', 'NO_NAME', or 'Untitled'.)

* New folders are created in the following cases:

- When pictures are added to folders containing files numbered 999.
- When using cards already containing the same folder number (including pictures taken with other cameras, etc.)
- File may not be able to be played back on camera after changing file name.

When using Windows XP, Windows Vista, Windows 7, or Mac OS X

The camera can be connected to your computer even if [USB MODE] is set to [PictBridge (PTP)].

- Only picture output can be performed from the camera. (Picture deletion can also be performed with Windows Vista and Windows 7.)
- It may not be possible to import if there are 1000 or more pictures on the card.

Playing motion pictures on your computer

- ① Use the 'QuickTime' software on the supplied CD-ROM.
 - Installed as standard on Macintosh
- ② Save motion pictures to your computer before viewing.

To cancel connection

Click 'Safely Remove Hardware' in the Windows System Tray → disconnect USB connection cable → turn off camera power → disconnect AC adaptor

- Do not use any other USB connection cables except the one supplied.
- Turn off power before inserting or removing memory cards.
- When the battery begins to run out during communication, warning beep sounds. Cancel communication via your computer immediately (recharge the battery before reconnecting).
- Setting the [USB MODE] to [PC] removes the need to make the setting each time the camera is connected to the computer.
- For more details, consult your computer operating manual.

Printing

You can connect directly to a PictBridge-compatible printer for printing.

Getting Ready:

- Use a fully charged battery or connect an AC adaptor (optional).
- When printing pictures from the built-in memory, remove any memory cards.
- Adjust the print quality or other settings on your printer, as needed.

Check socket direction and insert straight in.
(Damage to socket shape can lead to faulty operation.)

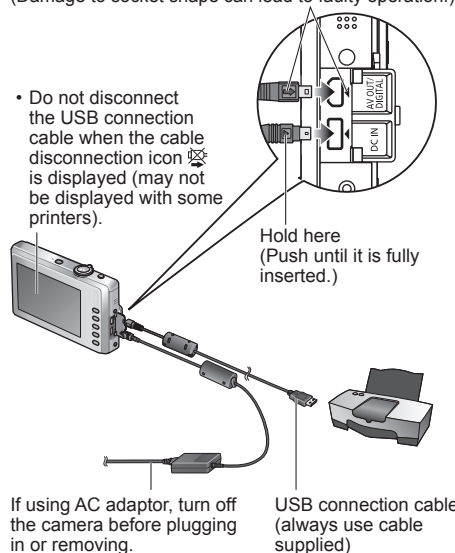

- Do not disconnect the USB connection cable when the cable disconnection icon is displayed (may not be displayed with some printers).

Hold here
(Push until it is fully inserted.)

If using AC adaptor, turn off the camera before plugging in or removing.

USB connection cable
(always use cable supplied)

■ To cancel print

Press [MENU]

- Do not use any other USB connection cables except the supplied one.
- Disconnect USB connection cable after printing.
- Turn off power before inserting or removing memory cards.
- If the battery runs out during communication, a warning beep will sound. Cancel printing and disconnect the USB connection cable. (Recharge the battery before reconnecting the camera and printer.)
- Setting the [USB MODE] to [PictBridge (PTP)] removes the need to make the setting each time the camera is connected to the printer.

1 Turn on power of both camera and printer

2 Connect camera to printer

- Please make sure you use the supplied USB connection cable. Use of cables other than the supplied USB connection cable may cause malfunction.

3 Touch [PictBridge (PTP)] on the camera

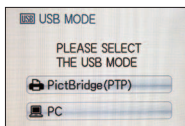

When [CONNECTING TO PC...] is displayed, cancel the connection and set [USB MODE] to either [SELECT ON CONNECTION] or [PictBridge (PTP)].

4 Select a picture to print with ◀▶ and touch [PRINT]

5 Touch [PRINT START]

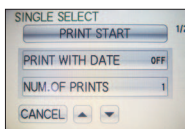

(Print settings (→82))

Some printers can print directly from the camera's memory card.
For details, see the manual for your printer.

Printing multiple pictures

- ① Touch [MULTI PRINT] in step 4 on the previous page.
- ② Select item (See below for details)
- ③ Print (Previous page 5)



- [MULTI SELECT] :① Touch pictures
 - To cancel → Touch again
 - ② Touch [SET]
 - [SELECT ALL] :Print all pictures.
 - [PRINT SET (DPOF)] :Print pictures selected in [PRINT SET].
 - [FAVORITE] :Print pictures selected as [FAVORITE]. (displayed only when [FAVORITE] pictures present and setting set to [ON]).
- Select [YES] if print confirmation screen is displayed.
 - An orange ● displayed during printing indicates an error message.
 - Print may be divided into different stints if printing several pictures. (Remaining sheets display may differ from set number.)

Print with date and text

■ With [TEXT STAMP]

Recording date and the following information can be embedded into still pictures.

- Recording date ● [NAME] and [AGE] from [BABY] and [PET] Scene Modes
- [TRAVEL DATE] elapsed days and destination
 - Do not add date printing in stores or with printers to still pictures where [TEXT STAMP] is applied (text may overlap).

■ Printing date without [TEXT STAMP]

- Printing in store: Only recording date can be printed. Request date printing in store.
 - Making [PRINT SET] settings on the camera in advance allows settings for numbers of copies and date printing to be designated before giving the card to the store.
 - When printing still pictures of 16:9 aspect ratio, check in advance that the store can accept this size.
- Using computer: Print settings for recording date and text information can be made using the supplied CD-ROM 'PHOTOfunSTUDIO'.
- Using printer :Recording date can be printed by setting [PRINT SET] on the camera, or by setting [PRINT WITH DATE] (→82) to [ON] when connecting to a printer compatible with date printing.

Printing (Continued)

Making print settings on camera

(Make settings before selecting [PRINT START])

① Select item

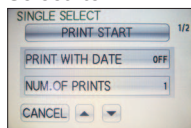

② Select setting

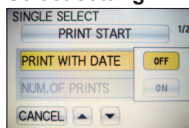

Item	Settings
[PRINT WITH DATE]	[OFF]/[ON]
[NUM. OF PRINTS]	Set number of pictures (up to 999 pictures)
[PAPER SIZE]	<div style="display: flex; justify-content: space-between;"> <div style="width: 45%;"> <p> (printer takes priority)</p> <p>[L/3.5"×5"] (89×127 mm)</p> <p>[2L/5"×7"] (127×178 mm)</p> <p>[POSTCARD] (100×148 mm)</p> <p>[16:9] (101.6×180.6 mm)</p> <p>[A4] (210×297 mm)</p> </div> <div style="width: 45%;"> <p>[A3] (297×420 mm)</p> <p>[10×15 cm] (100×150 mm)</p> <p>[4"×6"] (101.6×152.4 mm)</p> <p>[8"×10"] (203.2×254 mm)</p> <p>[LETTER] (216×279.4 mm)</p> <p>[CARD SIZE] (54×85.6 mm)</p> </div> </div>
[PAGE LAYOUT]	<div style="display: flex; justify-content: space-between;"> <div style="width: 45%;"> <p> (printer takes priority) / (1 picture, no border) / (1 picture, with border)</p> </div> <div style="width: 45%;"> <p> (2 pictures) / (4 pictures)</p> </div> </div>

- Items may not be displayed if incompatible with printer.
- To arrange '2 pictures' or '4 pictures' in the same still pictures, set the number of prints for the still pictures to 2 or 4.
- To print to paper sizes/layouts not supported by this camera, set to and make settings on the printer. (Consult your printer's operating manual.)
- [PRINT WITH DATE] and [NUM. OF PRINTS] are not shown when you have selected [PRINT SET] settings.
- Even with completed [PRINT SET] settings, dates may not be printed, depending on the shop or printer used.
- When setting [PRINT WITH DATE] to [ON], check the date printing settings on the printer (printer settings may be prioritized).

Viewing on TV screen

You can view still pictures and motion pictures on a TV by connecting the camera to your TV with the AV cable (supplied).

- Also consult TV operating manual.

Getting Ready:

- Complete the [TV ASPECT] setting.
- Turn off both the camera and television.

1 Connect camera to TV

2 Turn on TV

- Set to auxiliary input.

3 Turn on camera

4 Press the Playback button



Check socket direction and insert straight in.
(Damage to socket shape can lead to faulty operation.)

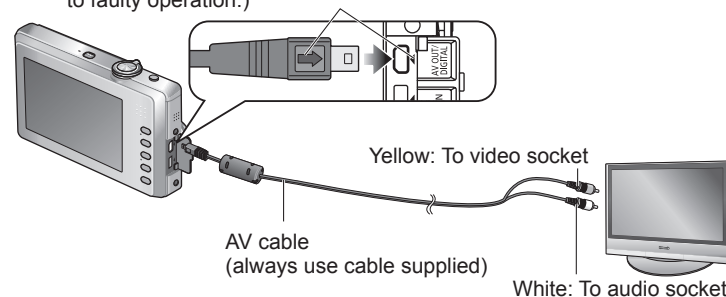

■ When using TVs with an SD card slot

Insert the SD memory card into the SD card slot

- Still pictures only can be played back.
- When using SDHC or SDXC memory cards, be sure to play each type of card in equipment compatible with the particular format.

- Do not use any other AV cables except the supplied one.
- You can play back pictures on TVs in other countries (regions) which use the NTSC or PAL system when you set [VIDEO OUT] in [SETUP] menu.
- [LCD MODE] setting is not reflected on TV.
- Some televisions may cut off the edges of pictures, or not display them full screen.
- Pictures rotated to portrait may be blurred slightly.
- Change settings for picture mode on TV if aspect ratios are incorrect on widescreen or high-definition televisions.

List of LCD monitor displays

Press the [DISPLAY] button to change display. (→7, 34)

In recording

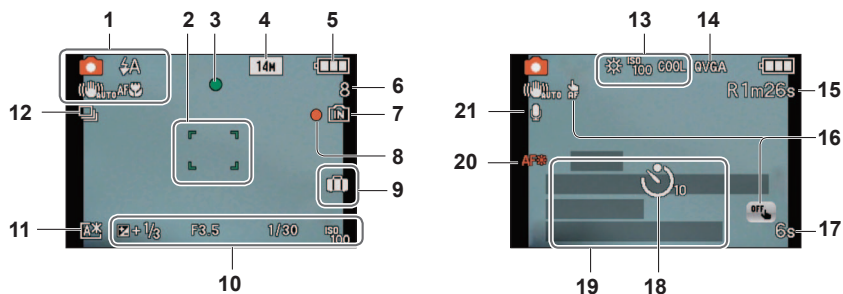

- 1 Recording Mode (→24)
Flash Mode (→36)
Optical Image Stabilizer (→61)
Jitter alert (→28)
Macro recording (→38)
 - 2 AF area (→28)
 - 3 Focus (→28)
 - 4 Picture size (→56)
 - 5 Battery capacity (→12)
 - 6 Number of recordable pictures (→96)
 - 7 Save destination (→12)
 - 8 Recording state
 - 9 Travel date (→53)
 - 10 Exposure compensation (→41)
Aperture value /
Shutter speed (→28)
ISO Sensitivity (→57)
- 0.5m - ∞
EZ W [] T 1X
- Focus range
Zoom (→30)
Macro Zoom (→39)
 - 11 LCD Mode (→19)
 - 12 Burst Mode (→60)
- 13 White Balance (→59)
ISO Sensitivity (→57)
Colour Mode (→61)
 - 14 Recording quality (→52)
 - 15 Remaining recording time (→51)
 - 16 Touch AF Area Selection (→40)
 - 17 Elapsed recording time (→51)
 - 18 Self-timer Mode (→35)
 - 19 Travel elapsed days (→53)
Name (→46)
Travel Location (→53)
Age in years/months (→46)
Current date/time
 - 20 AF Assist Lamp (→62)
 - 21 Audio recording (for motion pictures)

In playback

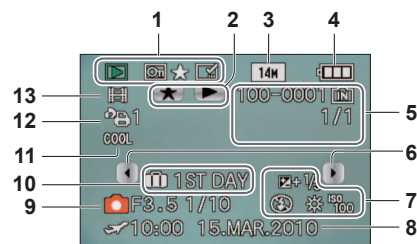

- 1 Playback Mode (→66)
Protected picture (→76)
Favourites (→74)
Text stamped display (→70)
- 2 Favourites settings (→74)
Playback button (→65)
- 3 Picture size (→56)
- 4 Battery capacity (→12)
- 5 Folder/File number (→32, 79)
Picture number/Total pictures (→32)
Motion picture recording time/
Elapsed playback time (→65)
Save destination (→12)
- 6 To go to the next picture/
To go to the previous picture (→32)
- 7 Recording information
- 8 Recorded date and time
Travel destination setting (→53)
Name (→46)
- 9 Recording information
Age in years/months (→46)
- 10 Travel elapsed days (→53)
- 11 Colour Mode (→61)
- 12 Quantity of pictures to print (→75)
- 13 Motion pictures (→65)
Cable disconnection warning icon (→80)

Screens shown here are only examples. The actual display may vary.

Message displays

Meanings and required responses to major messages displayed on LCD monitor.

[THIS MEMORY CARD CANNOT BE USED]

- A MultiMediaCard was inserted.
→ Not compatible with the camera. Use a compatible card.

[THIS MEMORY CARD IS WRITE-PROTECTED]

- Unlock the write-protect switch on the card. (→12)

[NO VALID PICTURE TO PLAY]

- Take pictures, or insert a different card already containing pictures.

[THIS PICTURE IS PROTECTED]

- Release the protection before deleting, etc. (→76)

[SOME PICTURES CANNOT BE DELETED] [THIS PICTURE CANNOT BE DELETED]

- Non-DCF pictures (→32) cannot be deleted.
→ Save needed data on a computer or other device, and then use [FORMAT] on the camera to erase the card. (→22)

[NO ADDITIONAL SELECTIONS CAN BE MADE]

- The number of pictures that can be deleted at once has been exceeded.
- More than 999 pictures have been set as [FAVORITE].
- The number of pictures allowing [TEXT STAMP] or [RESIZE] (multiple settings) at once has been exceeded.

[CANNOT BE SET ON THIS PICTURE]

- Pictures that do not conform to DCF standards cannot be used for [PRINT SET] and [TEXT STAMP].

[PLEASE TURN CAMERA OFF AND THEN ON AGAIN] [SYSTEM ERROR]

- The lens is not working correctly.
→ Turn on power again.
(Consult the dealer or your nearest Service Centre if display still remains)

[SOME PICTURES CANNOT BE COPIED] [COPY COULD NOT BE COMPLETED]

- Pictures cannot be copied in the following cases:
→ Picture of same name already exists in built-in memory when copying from card.
→ File is not of DCF standard.
→ Picture taken or edited on a different device.

[NOT ENOUGH SPACE ON BUILT-IN MEMORY] [NOT ENOUGH MEMORY ON THE CARD]

- There is no space left on the built-in memory or the card. When you copy pictures from the built-in memory to the card (batch copy), the pictures are copied until the capacity of the card becomes full.

[BUILT-IN MEMORY ERROR] [FORMAT BUILT-IN MEMORY?]

- Displayed when formatting built-in memory via computer, etc.
→ Reformat directly using camera. Data will be deleted.

[MEMORY CARD ERROR] [FORMAT THIS CARD?]

- The card format cannot be used with this camera.
→ Save needed data on a computer or other device, and then use [FORMAT] on the camera. (→22)

[INSERT SD CARD AGAIN] [TRY ANOTHER CARD]

- Access to card has failed.
→ Insert card again.
- Try with a different card.

[MEMORY CARD ERROR] [MEMORY CARD PARAMETER ERROR]

- Card is not of SD standard.
- When cards in capacities of 4 GB or more are used, only SDHC or SDXC memory cards are supported.

[READ ERROR]/[WRITE ERROR] [PLEASE CHECK THE CARD]

- Data read has failed.
→ Check whether card has been inserted correctly (→11).
- Data write has failed.
→ Turn off power and remove card, before re-inserting and turning on power again.
- Card may possibly be damaged.
- Try with a different card.

[MOTION RECORDING WAS CANCELLED DUE TO THE LIMITATION OF THE WRITING SPEED OF THE CARD]

- When recording motion picture, use a card rated with an SD speed class* of 'Class 6' or higher.
* SD speed class refers to a specification for sustained write speeds.
- If recording stops even when using a card with speed of 'Class 6' or faster, the data writing speed is low. We recommend backing up the data on the memory card and reformatting it. (→22)
- Motion picture recording may be automatically terminated with certain cards.

[A FOLDER CANNOT BE CREATED]

- Folder numbers in use have reached 999.
→ Save needed data on a computer or other device, and then use [FORMAT] on the camera. (→22)

[PICTURE IS DISPLAYED FOR 16:9 TV] [PICTURE IS DISPLAYED FOR 4:3 TV]

- AV cable is connected to camera.
→ To remove message immediately → Press [MENU].
→ To change aspect ratio → Change [TV ASPECT] (→22).
- USB connection cable is only connected to camera.
→ Message disappears when cable is also connected to another device.

[THIS BATTERY CANNOT BE USED]

- Use a genuine Panasonic battery.
- Battery cannot be recognised as terminal is dirty.
→ Wipe any dirt away from the battery terminal.

[NO BATTERY POWER REMAINS]

- The battery level is low.
→ Charge the battery before use. (→9)

Try checking these items (→88 - 93) first.
(Restoring menu settings to default values may solve certain problems.
Try using [RESET] in [SETUP] menu in Recording Mode (→21).)

Battery, power

Camera does not work even if power is turned on.

- Battery is not inserted correctly (→11), or needs recharging.

The power cuts off during use.

- Battery needs recharging.
- Camera is set to [AUTO POWER OFF]. (→20)
→ Press the Power button to turn the power on again.

Recording

Cannot record pictures.

- The camera is in Playback Mode.
→ Press the Playback button to switch to Recording Mode.
- The lens cover is closed.
→ Open the lens cover.
- Built-in memory/card is full. → Free space by deleting unwanted pictures (→33).

Cannot record to cards.

- Do not format cards on other equipment.
→ Please format cards with this camera. (→22)
- For details about compatible cards. (→12)

Recording capacity is low.

- Battery needs recharging .
→ Use a fully charged battery (not sold pre-charged). (→9)
→ If you leave the power on, the battery will be depleted. Turn the power off frequently by using [AUTO POWER OFF] (→20) etc.
- Please check the recording picture capacity for cards and built-in memory. (→96)

Recorded pictures look white.

- Lens is dirty (fingerprints, etc.).
→ Clean lens surface with a soft, dry cloth.
- Lens is foggy (→5).

Recorded pictures are too bright/too dark.

- Pictures taken in dark locations, or bright subjects (snow, bright conditions, etc.) occupy most of the screen. (Brightness of LCD monitor may differ from that of actual picture)
→ Adjust the exposure (→41).

2-3 pictures are taken when I press the shutter button just once.

- The camera is set to use [BURST] (→60) or [HI-SPEED BURST] (→47) or [FLASH BURST] (→48) Scene Modes.

Focus not aligned correctly.

- Not set to mode appropriate for distance to subject. (Focus range varies according to Recording Mode.)
- Subject outside of focus range.
- Caused by jitter or subject movement (→57, 61).

Recording (continued)

Recorded pictures are blurred. Optical Image Stabilizer ineffective.

- Shutter speed is slower in dark locations and Optical Image Stabilizer is less effective.
→ Hold camera firmly with both hands, keeping arms close to body.
→ Set [DIGITAL ZOOM] to [OFF] and [SENSITIVITY] to [ ISO]. (→31, 57)

Recorded pictures appear coarse, or there is interference.

- ISO Sensitivity is high, or shutter speed is low.
(Default [SENSITIVITY] setting is [ ISO] – interference may appear with indoor pictures.)
→ Lower [SENSITIVITY] (→57).
→ Set [COLOR MODE] to [NATURAL] (→61).
→ Take pictures in brighter locations.
- Camera set to [HIGH SENS.] or [HI-SPEED BURST] Scene Modes.
(Picture becomes slightly coarser in response to high sensitivity)

Pictures appear dark or have poor colouring.

- Colours may appear unnatural due to the effects of light source.
→ Use [WHITE BALANCE] to adjust the colouring. (→59)

Brightness or colouring of recorded picture different from real life.

- Taking pictures under fluorescent lighting may require a faster shutter speed and result in slightly changed brightness or colouring, but this is not a fault.

Red banding may appear on the LCD monitor or part or the entire screen may have a reddish tint, when recording or pressing the shutter button halfway.

- This is a characteristic of CCD and may appear if subject contains brighter areas. Some blurring may occur around these areas, but this is not a fault. This will be recorded in motion pictures, but not in still pictures.
- We recommend keeping the screen away from strong light sources such as sunlight when taking pictures.



Motion picture recording stops midway.

- With some cards, access display may appear briefly after recording, and recording may end midway.
- When recording motion picture, use a card rated with an SD speed class* of 'Class 6' or higher.
* SD speed class refers to a specification for sustained write speeds.
- If recording stops even when using a card with speed of 'Class 6' or faster, the data writing speed is low. We recommend backing up the data on the memory card and reformatting it. (→22)

LCD monitor

LCD monitor dims during motion picture recording.

- LCD monitor may dim if continuing motion picture recording for long periods.

Monitor sometimes shuts off even though power is on.

- After recording, monitor shuts off until next picture can be recorded. (Approx. 6 seconds (Max.) when recording to the built-in memory)

Brightness is unstable.

- Aperture value is set while shutter button is pressed halfway. (Does not affect recorded picture.)

Monitor flickers indoors.

- Monitor may flicker after turning on (prevents influence from fluorescent lighting).

Monitor is too bright/too dark.

- Camera set to [LCD MODE] (→19).

Black/blue/red/green dots or interference appears. Monitor looks distorted when touched.



- This is not a fault, and will not be recorded on the actual pictures, so there is no need to worry.

Date/age is not displayed.

- Current date, travel elapsed days (→53), and names and age in [BABY] and [PET] (→46) Scene Modes are only displayed for approx. 5 sec. when the camera is turned on, after these settings are made, or after switching from Playback Mode to Recording Mode, etc. They cannot be always displayed.

Flash

No flash emitted.

- Flash set to [FORCED FLASH OFF]  (→36).
- When set to [AUTO] , flash may not be emitted in certain conditions.
- Flash is disabled in the Scene Modes [SCENERY], [NIGHT SCENERY], [SUNSET], [HI-SPEED BURST], [FIREWORKS], [STARRY SKY], and [AERIAL PHOTO], and when [BURST] is used.
- No flash is emitted when recording a motion picture.

Multiple flashes are emitted.

- Red-eye reduction is active (→36). (Flashes twice to prevent eyes appearing red.)
- The Scene Mode is set to [FLASH BURST].

Playback

Pictures have been rotated.

- [ROTATE DISP.] is set to [ON]. (Automatically rotates pictures from portrait to landscape. Some pictures taken facing up or facing down may be interpreted as being portrait.)
→ Set [ROTATE DISP.] to [OFF]. (→74)

Cannot view pictures.

- Press the Playback button.
- No pictures in built-in memory or card (pictures are played from card if inserted, from built-in memory if card is not inserted).
- Camera set to [CATEGORY PLAY] or [FAVORITE PLAY].
→ Set Playback Mode to [NORMAL PLAY] (→66).

Playback (continued)

Folder/file number displayed as [-]. Picture is black.

- Picture edited on computer or taken on different device.
- Battery removed immediately after picture taken, or picture taken with low battery.
→ Use [FORMAT] to delete (→22).

Incorrect date displayed in Calendar Playback.

- Picture edited on computer or taken on different device.
- [CLOCK SET] is incorrect (→13). (Incorrect date may be displayed in Calendar Playback on pictures copied to computer and then back to camera, if computer and camera dates differ.)

Depending on the subject, an interference fringe may appear on the screen.

- This is called moire. This is not a malfunction.

White round spots like soap bubbles appear on the recorded picture.







- If you take a picture with the flash in a dark place or indoors, white round spots may appear on the picture caused by the flash reflecting particles of dust in the air. This is not a fault. A characteristic of this is that the number of round spots and their position differ in every picture.



[THUMBNAIL IS DISPLAYED] is shown on the screen.

- The still pictures may have been recorded on another device. If so, they may be displayed with poor picture quality.

Blackened red areas in recorded pictures.

- When digital red-eye correction (, , ) is operating, if a subject is recorded that has skin-coloured areas with red areas inside, the digital red-eye correction function may blacken the red areas.
→ We recommend setting the Flash Mode to ,  or , or [RED-EYE REMOVAL] to [OFF] before recording.

Sounds of camera operations will be recorded in motion pictures.

- Camera operation sounds may be recorded as camera automatically adjusts lens aperture during motion picture recording; this is not a fault.

Motion pictures recorded on this camera cannot be played on other devices.

- Motion pictures (Motion JPEG) recorded with this camera may not be played on digital cameras of other manufacturers. Additionally, motion pictures recorded with this camera cannot be played on Panasonic LUMIX digital cameras sold before July 2008. (However, motion pictures recorded with LUMIX digital cameras sold before this date can be played on this camera.)

TV, computer, printer

No pictures appear on TV. Pictures blurred or not coloured.

- Not connected correctly. (→83)
- The television has not been switched to auxiliary input.
- The television does not support the type of card used.
- Check the [VIDEO OUT] setting (NTSC/PAL) on the camera. (→22)

TV screen display different to LCD monitor.

- Aspect ratio may be incorrect or edges may be cut off with certain televisions.

Cannot play motion pictures on TV.

- Card is inserted into TV.
 - Connect the camera to the TV with the AV cable (supplied), and then access Playback Mode on the camera. (→83)

Picture is not displayed on full TV screen.

- Check [TV ASPECT] settings (→22).

Cannot send pictures to computer.

- Not connected correctly (→78).
- Check whether computer has recognised camera.
- Set [USB MODE] to [PC] (→21).

Computer does not recognise card (only reads built-in memory).

- Disconnect USB connection cable and reconnect with card in place.

I want to play computer pictures on my camera.

- Use the supplied software 'PHOTOfunSTUDIO' to copy pictures from computer to camera.

Cannot print when connecting to printer.

- Printer not compatible with PictBridge.
- Set [USB MODE] to [PictBridge (PTP)] (→21).

Cannot get the date printing.

- Make date printing settings before printing.
 - In shop: Make [PRINT SET] settings (→75), and request printing 'with dates'.
 - With printer: Make [PRINT SET] settings, and use a printer compatible with date printing.
 - With supplied software: Select 'with dates' within print settings.
- Use [TEXT STAMP] before printing (→70).

Edges cut off pictures when printing.

- Release any trimming or edgeless printing settings on printer before printing. (Consult printer operating manual.)
- The pictures were recorded in 16:9 aspect ratio.
 - If printing in shop, check if 16:9 sizes can be printed.

Others

Menu not displayed in desired language.

- Change [LANGUAGE] setting (→23).

Camera rattles if shaken.

- This sound is made by the lens movement and is not a fault. (→6)

Cannot set [AUTO REVIEW].

- Not available when [BURST] is used or in the Scene Modes [SELF PORTRAIT], [HI-SPEED BURST], or [FLASH BURST].

Red lamp illuminated when pressing shutter button halfway in dark locations.

- [AF ASSIST LAMP] set to [ON] (→62).

AF assist lamp is not illuminated.

- [AF ASSIST LAMP] is set to [OFF].
- Not illuminated in bright locations or when using [SCENERY], [NIGHT SCENERY], [SELF PORTRAIT], [FIREWORKS], [AERIAL PHOTO], or [SUNSET] Scene Modes.

Camera is hot.

- Camera may become a little warm during use, but this does not affect performance or quality.

Lens makes a clicking noise.

- When brightness changes, the lens may make a clicking noise and the monitor brightness may also change, but this is due to aperture settings being made. (Does not affect recording.)

Clock is incorrect.

- Camera has been left for a long period.
 - Reset the clock (→13).
- Long time was taken to set clock (clock behind by this amount).

When using zoom, picture becomes slightly warped and the edges of the subject become coloured.

- Pictures may be slightly warped or coloured around the edges, depending on the zoom ratio, but this is not a fault.

File numbers are not recorded in sequence.

- File numbers are reset when new folders are created (→79).

File numbers have jumped backwards.

- Battery was removed/inserted with power on. (Numbers may jump backwards if folder/file numbers are not correctly recorded.)

Touch panel operation cannot be done.

- This may occur when you keep touching the screen for too long a period of time. In this case, keep your finger away from the screen for about 10 seconds and try again.

The card is not recognized by the computer.

(You are using an SDXC memory card.)

- Make sure your computer supports SDXC memory cards. <http://panasonic.net/avc/sdcard/information/SDXC.html>
- When you insert a card, a message will be displayed requesting you to format the card, but do not format it.
- If [ACCESS] remains displayed on the LCD monitor, turn off the camera and then disconnect the USB cable.

Usage cautions and notes

When in use

- Camera may become warm if used for long periods of time, but this is not a fault.
- To avoid jitter, use a tripod and place in a stable location.
(Especially when using telescopic zoom, lower shutter speeds, or self-timer)
- **Keep the camera as far away as possible from electromagnetic equipment (such as microwave ovens, TVs, video games etc.).**
 - If you use the camera on top of or near a TV, the pictures and sound on the camera may be disrupted by electromagnetic wave radiation.
 - Do not use the camera near cell phones because doing so may result in noise adversely affecting the pictures and sound.
 - Recorded data may be damaged, or pictures may be distorted, by strong magnetic fields created by speakers or large motors.
 - Electromagnetic wave radiation generated by microprocessors may adversely affect the camera, disturbing the pictures and sound.
 - If the camera is adversely affected by electromagnetic equipment and stops functioning properly, turn the camera off and remove the battery or disconnect the AC adaptor (optional). Then reinsert the battery or reconnect the AC adaptor and turn the camera on.
- **Do not use the camera near radio transmitters or high-voltage lines.**
 - If you record near radio transmitters or high-voltage lines, the recorded pictures and sound may be adversely affected.
- Do not extend the supplied cord or cable.
- Do not allow camera to come into contact with pesticides or volatile substances (can cause surface damage or coating to peel).
- Never leave the camera and the battery in a car or on a car bonnet in the summer. It may cause leakage of the battery electrolyte, generation of heat, and may cause a fire and the battery to burst due to the high temperature.

Caring for your camera

To clean your camera, remove the battery or disconnect the power plug from the outlet, and wipe with a soft, dry cloth.

- Use a well-wrung wet cloth to remove stubborn stains, before wiping again with a dry cloth.
- Do not use benzene, thinners, alcohol, or kitchen detergent, as these may damage the outer casing and finish of the camera.
- If using a chemically-treated cloth, read the supplied instructions carefully.

When not using for a while

- Turn off camera power before removing battery and card (ensure that battery is removed to prevent damage through over-discharge).
- Do not leave in contact with rubber or plastic bags.
- Store together with a drying agent (silica gel) if leaving in drawer, etc. Store batteries in cool (15 °C - 25 °C) places with low humidity (40% - 60%) and no major temperature changes.
- Charge battery once per year and use completely before storing again.

Memory cards

- To prevent damage to cards and data
 - Avoid high temperatures, direct sunlight, electromagnetic waves, and static electricity.
 - Do not bend, drop, or expose to strong impacts.
 - Do not touch connectors on reverse of card or allow them to become dirty or wet.
- When disposing of/transferring memory cards
 - If using the 'format' or 'delete' functions on your camera or computer, this only changes the file management information, and does not completely delete the data from within the memory card. When disposing of or transferring your memory cards, we recommend physically destroying the memory card itself, or using commercially available computer data erasing software to completely delete the data from the card. Data within memory cards should be managed responsibly.

LCD Monitor

- Do not press hard on the LCD monitor. This may cause uneven display and damage the monitor.
- Do not press on the monitor with sharp, hard instruments such as ballpoint pens.
- Do not rub the LCD monitor forcefully or push on it.
- In cold climates or other situations when the camera becomes cold, the LCD monitor may be slightly less responsive than normal immediately after startup. Normal brightness will return once the internal components have warmed up.

Personal Information

If you complete [NAME] or [AGE] settings in [BABY] Mode, keep in mind that the camera and recorded pictures will contain personal information.

- Disclaimer
 - Data containing personal information can be altered or lost due to malfunction, static electricity, accidents, breakdowns, repairs, or other operations. Panasonic will not be liable for any damage that occurs, direct or indirect, as a result of the alteration or loss of data containing personal information.
- When ordering repairs or transferring/disposing of the camera
 - To protect your personal information, please reset the settings. (→21)
 - If any pictures are contained in the built-in memory, copy (→77) them to a memory card if necessary, and then format (→22) the built-in memory.
 - Remove the memory card from the camera.
 - When ordering repairs, the built-in memory and other settings may be returned to the initial purchase state.
 - If the above operations cannot be performed because of a camera malfunction, consult with the dealer or nearest Service Centre.

When transferring or disposing of your memory card, see 'When disposing of/transferring memory cards' in the previous section.

Recording picture/time capacity

- Figures given are estimates. May vary according to conditions, card type, and subject.
- Recording capacities/times displayed on LCD monitor may not be reduced regularly.

Recording picture capacity (still pictures)

- The number of pictures that can be stored varies depending on the [PICTURE SIZE] setting. (→56)
- When the number of recordable pictures exceeds 99,999, '+99999' is displayed.

Picture aspect ratio	4:3					3:2	16:9	
[PICTURE SIZE]	14 M 4320×3240	10 M EZ 3648×2736	5 M EZ 2560×1920	3 M EZ 2048×1536	0.3 M EZ 640×480	12.5 M 4320×2880	10.5 M 4320×2432	
Built-in memory	8	12	20	27	200	9	11	
Memory card	256 MB	48	68	110	150	1080	54	65
	512 MB	97	135	220	300	2150	105	125
	1 GB	195	270	440	600	4310	210	250
	2 GB	390	550	900	1220	8780	440	520
	4 GB	780	1080	1770	2410	17240	880	1030
	6 GB	1190	1650	2690	3660	26210	1330	1580
	8 GB	1590	2210	3610	4910	35080	1790	2110
	12 GB	2400	3330	5440	7400	52920	2700	3190
	16 GB	3200	4450	7260	9880	70590	3600	4250
	24 GB	4650	6460	10550	14350	102500	5230	6180
	32 GB	6430	8930	14570	19820	141620	7230	8540
48 GB	9330	13000	21420	28020	182140	10400	12560	
64 GB	12670	17650	29070	38020	247160	14120	17040	

Recording time capacity (motion pictures)

- The available recording time varies depending on the [REC QUALITY] setting. (→52)

[REC QUALITY]	[HD]	[WVGA]	[VGA]	[QVGA]
Built-in memory	—	—	—	1 min 26 s
Memory card	256 MB	59 s	2 min 35 s	2 min 40 s
	512 MB	2 min	5 min 10 s	5 min 20 s
	1 GB	4 min	10 min 20 s	10 min 50 s
	2 GB	8 min 20 s	21 min 20 s	22 min 10 s
	4 GB	16 min 30 s	41 min 50 s	43 min 40 s
	6 GB	25 min 10 s	1 h 3 min	1 h 6 min
	8 GB	33 min 40 s	1 h 25 min	1 h 28 min

[REC QUALITY]	[HD]	[WVGA]	[VGA]	[QVGA]
Memory card	12 GB	50 min 50 s	2 h 8 min	2 h 14 min
	16 GB	1 h 8 min	2 h 52 min	2 h 59 min
	24 GB	1 h 38 min	4 h 9 min	4 h 19 min
	32 GB	2 h 16 min	5 h 45 min	5 h 59 min
	48 GB	3 h 20 min	8 h 27 min	8 h 48 min
	64 GB	4 h 29 min	11 h 22 min	11 h 50 min
				34 h 3 min

- Motion pictures can be recorded continuously up to 2 GB. To record more than 2 GB, press the shutter button again. (Remaining time for continuous recording is displayed on the screen.)
The time displayed in the table is the total time.



- SDXC Logo is a trademark of SD-3C, LLC.
- QuickTime and the QuickTime logo are trademarks or registered trademarks of Apple Inc., used under license therefrom.
- Other names, company names, and product names printed in these instructions are trademarks or registered trademarks of the companies concerned.