

Panasonic®

Operating Instructions for advanced features

Digital Camera

Model No. **DMC-S3**
DMC-S1

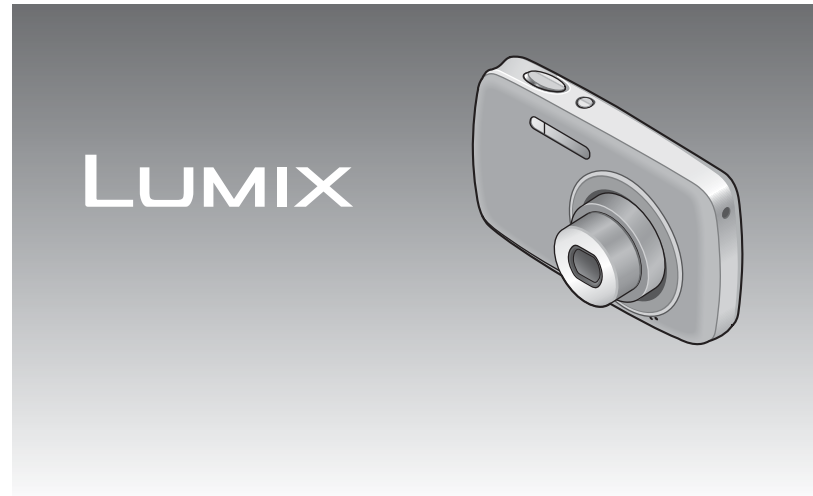

Before use, please read these instructions completely.



Contents

Before use

Before use	4
Standard Accessories	6
Names of parts	7
Cursor button	7

Preparations

Charging the battery	8
Guidelines for the number of recordable pictures and operating time	9
Inserting and removing the card (optional)/the battery	11
Using the DC coupler (optional) instead of battery	13
Picture save destination (cards and built-in memory)	14
Remaining battery and memory capacity	15
Recording capacity guidelines (pictures/recording time)	15
Setting the clock	16

Basics

Taking pictures with automatic settings [Intelligent Auto] Mode	18
Taking pictures with zoom	20
Taking motion pictures [Motion Picture] Mode	21
Viewing your pictures [Normal Play]	22
Watching motion pictures	23
Viewing as list (Multi Playback/Calendar Playback)	24
Deleting pictures	25
To delete multiple (up to 50) or all pictures	25
Setting the menu	26
Using the [Setup] menu	28
[Clock Set]	28
[World Time]	28
[Beep]	28
[Volume]	28
[Focus Icon]	28
[Auto Power Off]	28
[Auto Review]	29
[Reset]	29
[Output]	29
[Rotate Disp.]	30
[Version Disp.]	30
[Format]	30
[Language]	31
[Demo Mode]	31

Recording

Taking pictures with your own settings [Normal Picture] Mode	32
Aligning the focus	33
Changing recording information display	34
Taking pictures with the self-timer	35
Taking pictures with flash	36
Taking pictures with Exposure Compensation	38
Taking pictures according to the scene [Scene Mode]	39
[Portrait]	40
[Soft Skin]	40
[Self Portrait]	40
[Scenery]	40
[Panorama Assist]	41
[Sports]	41
[Night Portrait]	42
[Night Scenery]	42
[Food]	42
[Party]	42
[Baby]	43
[Sunset]	43
[High Sens.]	43
[Fireworks]	44
[Beach]	44
[Snow]	44
Useful features for travel [World Time]	45
Using the [Rec] menu	46
[Picture Size]	46
[Rec Quality]	47
[Sensitivity]	47
[White Balance]	48
[AF Mode]	49
[Digital Zoom]	50
[Burst]	50
[Color Mode]	51
[AF Assist Lamp]	51
[Red-Eye Removal] (DMC-S3 only)	51
[Stabilizer]	52
[Date Stamp]	52
[Clock Set]	52

Playback/Editing

Different playback methods (Playback Mode)	53
[Slide Show]	54
[Filtering Play]	55
[Calendar]	55
Using the [Playback] menu	56
[Upload Set]	56
[Resize]	58
[Favorite]	60
[Protect]	61
[Copy]	62

Connecting with other devices

Using with your PC	63
Using "PHOTOfunSTUDIO" to copy pictures to your computer	65
Uploading pictures to image-sharing websites	65
Printing	66
Printing multiple pictures	67
Print with date	67
Making print settings on the camera	68
Viewing on TV screen	69

Others

List of LCD monitor displays	70
Message displays	72
Q&A Troubleshooting	74
Usage cautions and notes	80

Before use

■ Camera handling



Keep the camera away from excessive vibration, force, or pressure.

- Avoid using the camera under the following conditions, which may damage the lens, LCD monitor, or camera body. This may also cause the camera to malfunction or prevent recording.
 - Dropping or hitting the camera against a hard surface
 - Sitting down with the camera in your pants pocket or forcing it into a full bag
 - Adding accessories to the camera strap
 - Pushing with excessive force on the lens or LCD monitor

The camera is not dust resistant, splash resistant, or waterproof.

Avoid using the camera in places with excessive dust or sand, or where water can come into contact with the camera.

- Avoid using the camera under the following conditions, which present a risk that sand, water, or foreign material may enter the camera through the lens or openings around buttons. Be especially careful, because these conditions may damage the camera and such damage may not be repairable.
 - In extremely dusty or sandy places
 - In the rain or by the shore, where the camera may be exposed to water

■ Condensation (lens clouding)

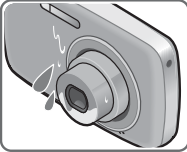

- Condensation may occur when the camera is exposed to sudden changes of temperature or humidity. Avoid these conditions, which may make the lens dirty, cause mold, or damage the camera.
- If condensation does occur, turn off the camera and wait about two hours before using it. Once the camera adjusts to the surrounding temperature, clouded lenses will clear naturally.

■ Always take a test shot first

Before important events when you will use the camera (at weddings, for example), always take a test shot to make sure that pictures and sound record correctly.

■ No compensation for missed shots

We cannot compensate for missed shots if technical problems with the camera or card prevent recording.

■ Carefully observe copyright laws

Unauthorized use of recordings which contain works with copyright for purposes other than personal use is prohibited under copyright law. Recording of certain material may be restricted even for the purpose of personal use.

■ Also refer to “Usage cautions and notes” (→80)

Standard Accessories

Check that all the accessories are supplied before using the camera.

- The accessories and their shape will differ depending on the country or area where the camera was purchased.

For details on the accessories, refer to Basic Operating Instructions.

- Battery Pack is indicated as battery pack or battery in the text.
- Battery Charger is indicated as battery charger or charger in the text.
- Please dispose of all packaging appropriately.
- Keep small parts in a safe place out of the reach of children.

Optional accessories

- Memory cards and AV cable are optional. You can record or play back pictures on the built-in memory when you are not using a card.
- Consult the dealer or your nearest Service Centre if you lose the supplied accessories. (You can purchase the accessories separately.)

Names of parts

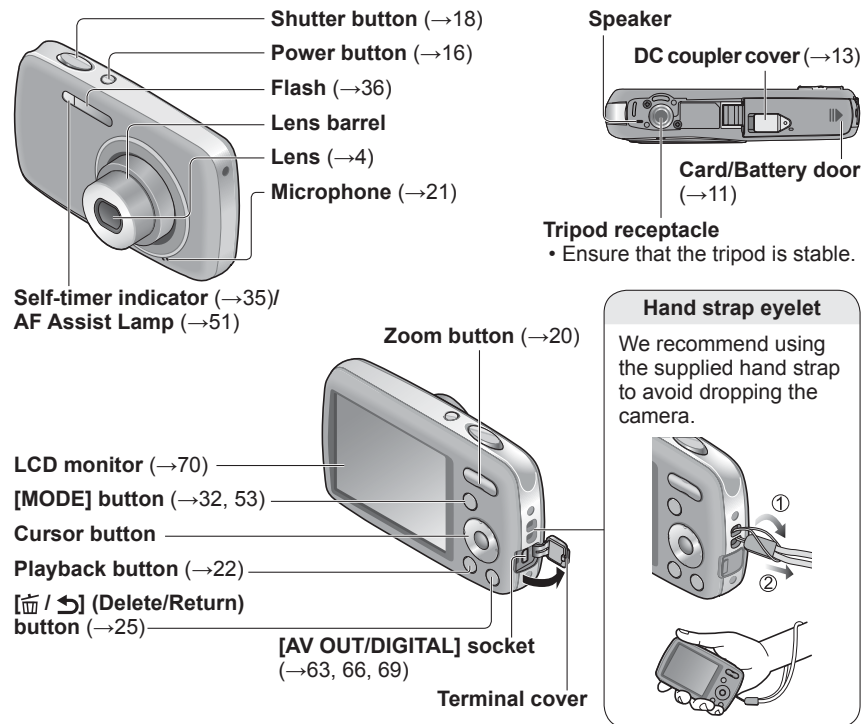

Cursor button

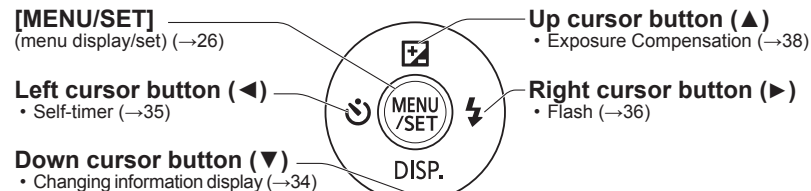

- In this manual, the button that is used is shaded or indicated by ▲▼◀▶.

- The illustrations and screens in this manual may differ from the actual product.
- Some tripods or unipods, and some methods of holding the camera may block the speaker, making it difficult to hear the beep, etc.

Charging the battery

Always charge before first use! (battery shipped uncharged)

■ About batteries that you can use with this unit

Supplied battery or dedicated optional batteries can be used with this unit. Refer to Basic Operating Instructions about the accessory number of the available optional batteries in your area.

It has been found that counterfeit battery packs which look very similar to the genuine products are made available to purchase in some markets. Some of these battery packs are not adequately protected with internal protection to meet the requirements of appropriate safety standards. There is a possibility that these battery packs may lead to fire or explosion. Please be advised that we are not liable for any accident or failure occurring as a result of use of a counterfeit battery pack. To ensure that safe products are used we recommend that a genuine Panasonic battery pack is used.

- Use the dedicated charger and battery.

1 Insert the battery terminals and attach the battery to the charger



2 Connect the charger to the electrical outlet

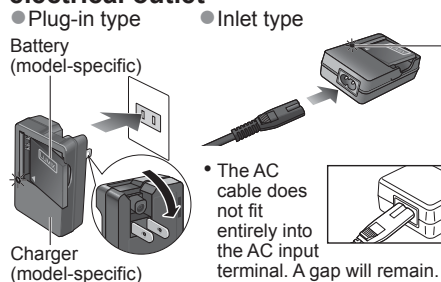

Charging light ([CHARGE])

On: Charging in progress (approx. 115 min. if fully depleted)*

* Charge time is approx. 120 min. for the optional battery

Off: Charging complete

If light is flashing:

- Charging may take longer than normal if battery temperature is too high or too low (charging may be incomplete).
- Battery/charger connector is dirty. Clean with a dry cloth.

3 Detach the battery after charging is completed

Guidelines for the number of recordable pictures and operating time

The number of recordable pictures or available operating time may vary according to surrounding environment and usage conditions. Figures may be reduced if flash, zoom, or other functions are used frequently, or in colder climates.

	Supplied battery	Optional battery
Capacity	660 mAh	680 mAh
Number of recordable pictures	Approx. 250*1/240*2 pictures	Approx. 255*1/245*2 pictures
Recording time	Approx. 125*1/120*2 min.	Approx. 127*1/122*2 min.

*1 DMC-S3

*2 DMC-S1

● Recording conditions by CIPA standard

- CIPA is an abbreviation of [Camera & Imaging Products Association].
- [Normal Picture] Mode.
- Temperature: 23 °C/Humidity: 50 %RH when LCD monitor is on.
- Using a Panasonic SD Memory Card (32 MB).
- Using the supplied battery.
- Starting recording 30 seconds after the camera is turned on. (When the Optical Image Stabilizer function is set to [ON].)
- Recording once every 30 seconds with full flash every second recording.
- Perform a zoom operation every recording (W end → T end, or T end → W end)
- Turning the camera off every 10 recordings and leaving it until the temperature of the battery decreases.

Number reduced if intervals are longer – e.g. to approx. one quarter for 2-minute intervals under the above conditions.

	Supplied battery	Optional battery
Playback time	Approx. 200 min.	Approx. 205 min.

Charging the battery (Continued)

- The time required for charging varies depending on conditions of battery usage. Charging takes longer at high or low temperatures and when the battery has not been used for some time.
- Battery will be warm during charging and for some time thereafter.
- Battery will run out if not used for long periods of time, even after being charged.
- Charge the battery with the charger indoors (10 °C to 30 °C).
- Keep any metal items (such as clips) away from the contact areas of the power plug. Otherwise, a fire and/or electric shocks may be caused by short-circuiting or resulting heat generated.
- We do not recommend frequently charging the battery.
(Frequently charging battery reduces maximum usage time and can cause battery to expand.)
- Do not disassemble or modify the charger.
- If available battery power is significantly reduced, battery is reaching end of lifespan. Please purchase a new battery.
- The battery charger is in the standby condition when the AC power is supplied. The primary circuit is always "live" as long as the battery charger is connected to an electrical outlet.
- When charging:
 - Remove any dirt on connectors of charger and battery with dry cloth.
 - Keep at least 1 m (3.28 feet) away from AM radio (may cause radio interference).
 - Noises may be emitted from inside of charger, but this is not a fault.
 - Remove charger from wall socket after charging (up to 0.1 W consumed if left in place).
- Do not use a damaged or dented battery (especially connectors), e.g. by dropping (can cause faults).

Inserting and removing the card (optional)/the battery

- 1** Turn off the power and slide the card/battery door out (①) before opening the door (②) as illustrated



- 2** Insert the battery and card, making sure that their orientation is correct

- Battery: Insert all the way firmly until a locking sound is heard, and check that the lever is hooked over the battery.
- Card: Insert all the way firmly until it clicks.

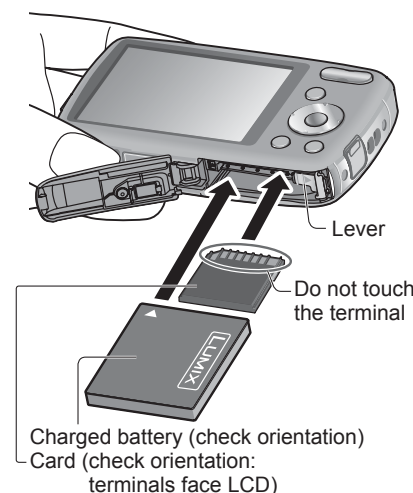

- 3** Close the card/battery door and slide the door in until you hear a locking sound

Inserting and removing the card (optional)/ the battery (Continued)

■ To remove

• To remove battery:

- move lever in direction of arrow.



• To remove card:

- press down in centre.



- Always use genuine Panasonic batteries.
- If you use other batteries, we cannot guarantee the quality of this product.
- Remove battery from camera after use.
 - Keep the battery in a plastic bag, making sure that it is kept away from metallic objects (such as clips) when carrying or storing the battery.
- To remove the card or battery, turn the camera off and wait until the LCD monitor display is completely blank. (Failure to wait may cause the camera to malfunction and may damage the card or recorded data.)
- Keep the Memory Card out of reach of children to prevent swallowing.

Using the DC coupler (optional) instead of battery

By using the AC adaptor (optional) and DC coupler (optional), you can record and play back without worrying about the remaining battery charge.

The optional DC coupler can only be used with the designated Panasonic AC adaptor.

1 Insert DC coupler instead of battery

2 Open DC coupler cover

- If difficult to open, press the DC coupler cover from inside to open it.

3 Close the card/battery door and slide the door in until you hear a locking sound

4 Plug AC adaptor into power outlet

5 Connect AC adaptor to DC IN socket of DC coupler

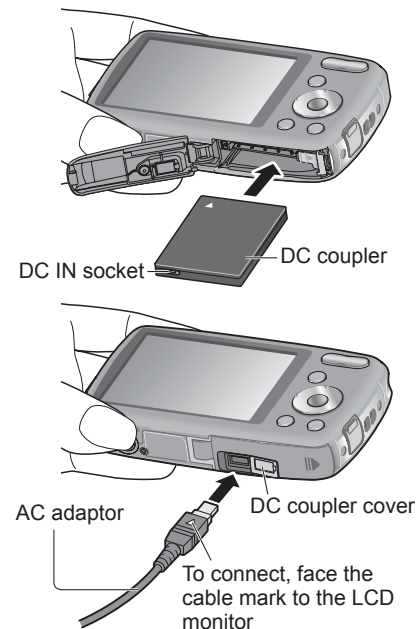

- Always use a genuine Panasonic AC adaptor (optional).
- Use the AC adaptor and DC coupler specifically for this camera. Using other adaptors or couplers could cause camera failure.
- The possibility to install the camera on a tripod or unipod when the DC coupler is connected depends on the type of tripod or unipod.
- The camera cannot stand upright when the AC adaptor is connected. If you are leaving the camera on a surface as you work, it is recommended to place it on a soft cloth.
- When the AC adaptor is connected, always remove the AC adaptor when opening the card/battery door.
- Remove the AC adaptor and DC coupler when not in use and close the coupler cover.
- Also read the AC adaptor and DC coupler operating instructions.

Inserting and removing the card (optional)/ the battery (Continued)

Picture save destination (cards and built-in memory)

Pictures will be saved to a card if one is inserted, or to the built-in memory  if not.

- **Built-in memory (DMC-S3: Approx. 70 MB/DMC-S1: Approx. 20 MB)**
- Pictures may be copied between cards and the built-in memory (→62).
- The access time for the built-in memory may be longer than the access time for a card.
- [QVGA] in [Rec Quality] can only be available to record motion pictures in the built-in memory.

Compatible memory cards (optional)

The following SD standard-based cards (Panasonic brand recommended)

Type of Card	Capacity	Notes
SD Memory Cards	8 MB – 2 GB	<ul style="list-style-type: none"> • Can be used with devices compatible with the respective formats. • Before using SDXC Memory Cards, check that your computer and other devices support this type of card. http://panasonic.net/avc/sdcard/information/SDXC.html • Only the cards listed on the left with the given capacities are supported. • Using a card of SD Speed "Class 6"* or above is recommended for recording motion pictures.
SDHC Memory Cards	4 GB – 32 GB	
SDXC Memory Cards	48 GB, 64 GB	

* SD speed class refers to a specification for sustained write speeds. Confirm the SD speed by checking the card label or other card related materials.

(Example) Class 6 

- Please reformat the card with this camera if it has already been formatted with a computer or another device. (→30)
- If the write-protect switch is set to "LOCK", the card cannot be used to record or delete pictures, and it cannot be formatted.
- It is recommended that you copy important pictures to your computer (as electromagnetic waves, static electricity, or faults may cause data to be damaged).
- Latest information:
<http://panasonic.jp/support/global/cs/dsc/> (This Site is English only.)

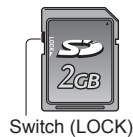

Switch (LOCK)

Remaining battery and memory capacity

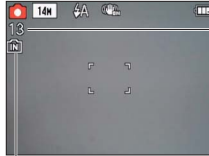

Remaining battery (only when using battery)





(flashes red)

If the battery mark flashes red, recharge or replace battery.

Estimated remaining pictures or recording time capacity (press ▼ to display on/off)

Displayed when no card is inserted (pictures will be saved to built-in memory)

When in operation

 (Card) or  (Built-in memory) are illuminated red. While the light remains lit, an operation is taking place, such as picture writing, reading, deletion or formatting. While the light is lit, do not turn off the power or remove battery, card, AC adaptor (optional) or DC coupler (optional), as this can cause data loss or damage. Keep the camera away from vibrations, impact, or static electricity. Should any of these cause camera operation to be terminated, attempt to perform the operation again.

Recording capacity guidelines (pictures/recording time)

The number of pictures you can take and the recording time varies in proportion to card capacity (and depending on recording conditions and type of card).

- When [Upload Set] is set, the number of pictures that can be recorded or the recording time may decrease.

Recording picture capacity (still pictures)

[Picture Size]	Built-in memory	2 GB	4 GB	16 GB				
4:3 14M *1	13	330	670	2740				
4:3 12M *2	4	450	910	3720				
4:3 5M	26*1	9*2	650*1	890*2	1300*1	1780*2	5300*1	7280*2
4:3 0.3M	410*1	115*2	10050	19940	81340			

- When the number of recordable pictures exceeds 99,999, "+99999" is displayed.

Recording time capacity (motion pictures)

[Rec Quality]	Built-in memory	2 GB	4 GB	16 GB	
[HD]	—	8 min 10 s	16 min 20 s	1 h 7 min	
[VGA]	—	21 min 40 s	43 min 10 s	2 h 56 min	
[QVGA]	2 min 30 s*1	41 s*2	1 h 2 min	2 h 4 min	8 h 28 min

- Motion pictures can be recorded continuously up to 2 GB. To record more than 2 GB, press the shutter button again. (Remaining time for continuous recording is displayed on the screen.) The time displayed in the table is the total time.

*1 DMC-S3

*2 DMC-S1

Setting the clock

The clock is not set when the camera is shipped.

1 Press the Power button

The power is turned on.
If the language select screen is not displayed, proceed to step 4.



2 Press [MENU/SET] while the message is displayed



3 Press ▲ ▼ to select the language, and press [MENU/SET]

4 Press [MENU/SET]

5 Press ◀ ▶ to select the items (year, month, day, hour, minute, display order or time display format), and press ▲ ▼ to set

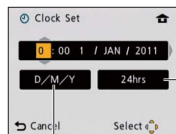
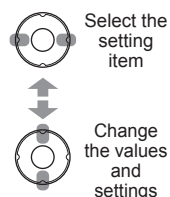

Select either [24hrs] or [AM/PM] for the time display format.

Select the display order for the day, month, and year ([M/D/Y], [D/M/Y], or [Y/M/D]).

• To cancel → Press [Left] / [Right].

6 Press [MENU/SET]

7 Confirm the setting and press [MENU/SET]

• To return to the previous screen, press [Left] / [Right].
• Turn on power again and check time display.
(Time and date can be displayed by pressing ▼ several times.)

To change time setting

Select [Clock Set] from [Setup] or [Rec] menu, perform 5 and 6.

• Clock settings will be saved for approx. 3 months even after battery is removed, provided a fully-charged battery was installed in the camera for 24 hours beforehand.

- Failure to set the date and time will cause the date/time to be improperly printed when printing pictures at a digital photo centre or when using [Date Stamp].
- After the time has been set, the date can be printed correctly even if the date is not displayed on the camera screen.

Taking pictures with automatic settings

[Intelligent Auto] Mode

Recording Mode: **iA**

Optimum settings are made automatically from information such as “face,” “movement,” “brightness,” and “distance” just by pointing the camera at the subject, meaning that clear pictures can be taken without the need to make settings manually.

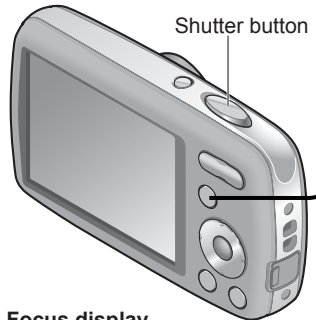

Shutter button

1 Display the screen for Recording Mode selection



2 Select [Intelligent Auto] Mode

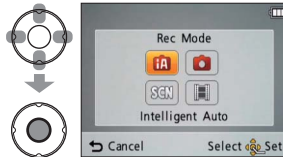

3 Take pictures

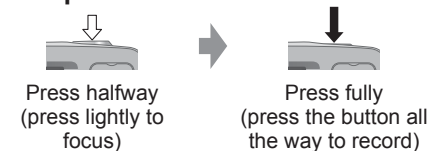

Focus display

(When focus is aligned: illuminated
When focus is not aligned: flashing)



The type of scene detected is indicated by a blue icon for two seconds

■ Holding the camera

AF Assist Lamp/Flash



Speaker

- If jitter becomes noticeable, use both hands, keep your arms close to your body, and stand with your feet at shoulder width.
- Do not touch the lens.
- Do not block the flash or the AF Assist Lamp. Do not look at it from close range.
- Try to hold the camera steady when you press the shutter button.
- Be careful not to block the speaker.
- We recommend the use of the hand strap to avoid dropping the camera.

■ To use flash

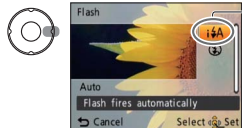

Select either **iA** or **S**.

- When **iA** is selected, the type of flash automatically changes according to the subject and brightness. (→36)
- **iA** and **iS** indicate that the Red-Eye Reduction function is activated.
- The shutter speed is slower in **iS** and **iS**.

■ Automatic Scene Detection

Camera identifies the scene when pointed at the subject, and makes optimum settings automatically.

People are detected	People and night scenery are detected (Only when iA is selected)
Scenery is detected	Night scenery is detected
A close-up shot is detected	A sunset is detected
Reads subject movement to avoid blurring when the scene does not correspond to any of the above.	

If the camera automatically identifies the scene and determines that people appear as subjects in the picture (or), Face Detection is activated, and the focus and exposure are adjusted for the recognised faces.

- According to the following conditions, different scene types may be determined for the same subject:
Face contrast, conditions of subject (size, distance, colouring, contrast, movement), zoom ratio, sunset, sunrise, low brightness, jitter
- If undesired scene type is selected, we recommend manually selecting the appropriate Recording Mode.
- We recommend using a tripod and the self-timer with and .

- In addition to Automatic Scene Detection, [**F ISO**] in [Sensitivity] and Backlight Compensation will operate automatically.
- The following menu items may be set in [Intelligent Auto] Mode:
 - [Rec] menu: [Picture Size]*1, [Burst], [Color Mode]*1
 - [Setup] menu*2: [Clock Set], [World Time], [Beep], [Language], [Stabilizer Demo.]
- *1 Items that may be set differ from other Recording Modes.
- *2 Other items in the [Setup] menu will reflect settings made in other Recording Modes.
- Backlight Compensation
Backlight refers to the light that shines from behind the subject. When this occurs, the subject appears darker, and so backlighting is automatically corrected by increasing the brightness of the entire image.
- The settings for the following functions are fixed:
 - [Auto Review]: [ON]
 - [Auto Power Off]: [5 MIN.]
 - [White Balance]: [AWB]
 - [AF Mode]: (Face Detection)*3
 - [Stabilizer]: [ON]
 - [AF Assist Lamp]: [ON]
 - [Red-Eye Removal]*4: [ON]
- *3 (11-area-focusing) when face cannot be recognised
- *4 DMC-S3 only
- The following functions cannot be used:
[Exposure], [Digital Zoom]

Taking pictures with zoom

Recording Mode:

“Optical Zoom” offers 4 x magnification. You can zoom in even closer without the loss of picture quality by lowering the picture size and using “Extra Optical Zoom.” For zooming in even closer, “Digital Zoom” (→50) is available.

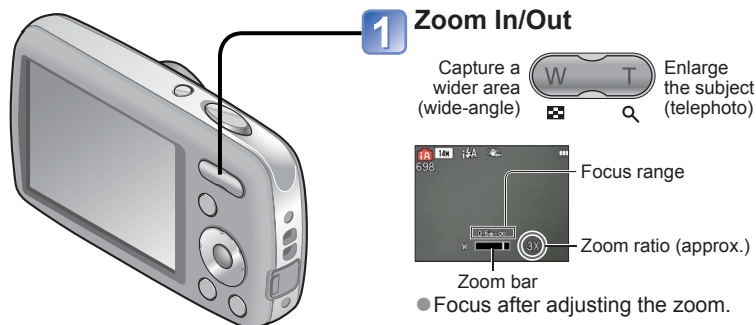

Optical Zoom and Extra Optical Zoom (EZ)

Automatically switches to “Optical Zoom” when using maximum Picture Size (→46), and to “Extra Optical Zoom” (for further zooming) otherwise. (EZ is short for “Extra Optical Zoom”.)

• Optical Zoom



• Extra Optical Zoom



(EZ displayed)

- Extra Optical Zoom system
When the recording pixel level is set to [3 M] (corresponding to 3 million pixels), 3 million pixels of the available pixel level in the centre of the CCD are used in recording, enabling higher magnification.
- The zoom ratio and the zoom bar displayed on the screen are estimates.
- Extra Optical Zoom cannot be used in the following cases:
Motion Picture, [High Sens.] in Scene Mode

Taking motion pictures

[Motion Picture] Mode

Recording Mode:

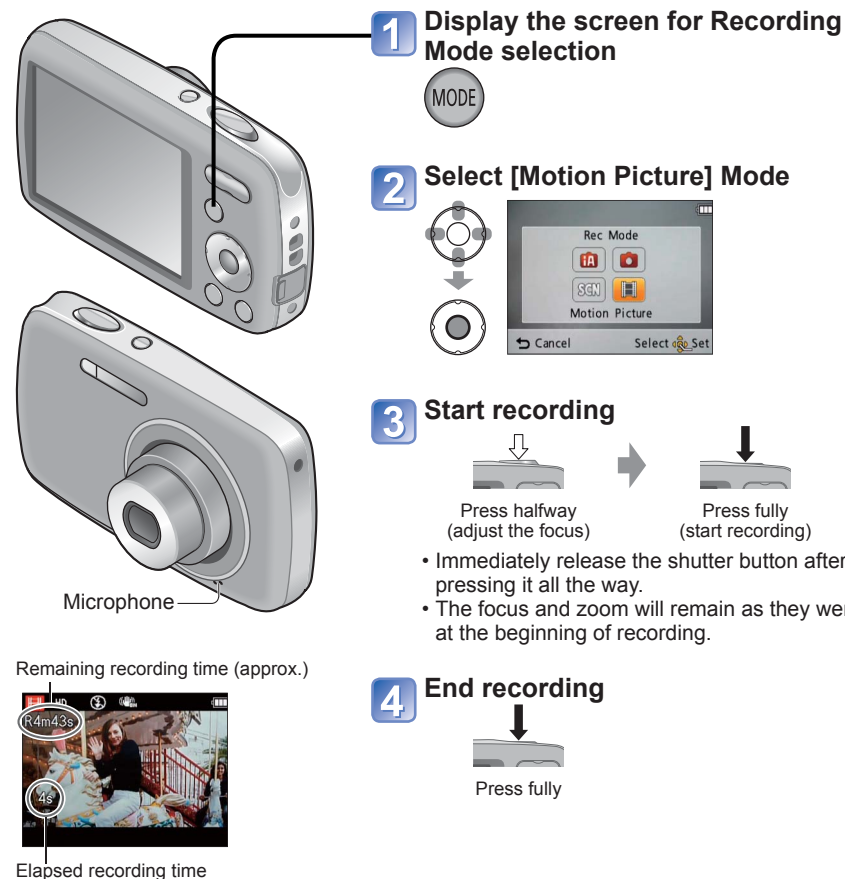

- Depending on the type of card used, a card-access display may appear for a while after motion picture recording. This is not a fault.
- In [AF Mode], (11-area-focusing) is fixed.
- In [Stabilizer], [ON] is fixed.
- When there is no space left to store the motion picture, recording automatically ends. Additionally, recording in progress may be stopped, depending on the card used.

Viewing your pictures [Normal Play]

Playback Mode:

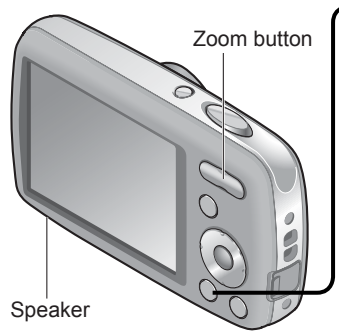

When a card is in the camera, pictures are played back from the card, and without a card, pictures are played back from the built-in memory.



1 Press the Playback button

- Press again to enter the Recording Mode.

2 Scroll through pictures



File number
Picture number/Total pictures

- Hold down to quickly scroll forwards/backwards.
- Press the shutter button to switch to Recording Mode.

■ To enlarge (Playback Zoom)

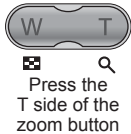

- Each time the T side of the zoom button is pressed, the magnification increases. It moves through four levels after 1x: 2x, 4x, 8x, and 16x. (The picture quality displayed becomes successively lower.)
- To reduce zoom → Press the W side of the zoom button
- Move zoom position →

- Be careful not to block the speaker.
- Some pictures edited on a computer may not be viewed on this camera.
- This camera is compliant with the unified DCF (Design rule for Camera File system) standard formulated by the Japan Electronics and Information Technology Industries Association (JEITA), and with Exif (Exchangeable image file format). Only files that are DCF-compliant can be played back.

Watching motion pictures

1 Select the motion picture and start playback

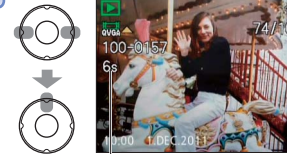

Motion picture recording time*

* When playback starts, the elapsed playback time is displayed in the top right of the screen.

Example: After 3 minutes and 30 seconds: [3m30s]

■ Operations during Motion Picture Playback



- ▲: Pause/Play
- [MENU/SET]: Stop
- ◀: Fast rewind (2 steps)
Single-frame rewind (while paused)
- ▶: Fast forward (2 steps)
Single-frame forward (while paused)

- Press ▲ during fast rewind or fast forward to return to the normal playback speed.
- The volume can be adjusted with the zoom button.

- Motion pictures recorded on other devices may not be played correctly.
- When watching on a computer, use [QuickTime] on the supplied CD-ROM to play motion pictures.

Viewing as list (Multi Playback/Calendar Playback)

Playback Mode:

You can view 12 (or 30) pictures at once (Multi Playback), or view all pictures taken on a certain date (Calendar Playback).

1 Press the Playback button

2 Set to multiple screen display

The display changes each time the W side is pressed

Date recorded Picture no. Total no. Scroll bar

(12 screens)

(30 screens)

Selected date (First picture from the date)

• Select week with ▲▼ and date with ◀▶, and press [MENU/SET] to display that date's pictures on a 12-screen display.

(Calendar screen)

■ To restore

Press the T side of the zoom button

■ To change from 12/30-screen display to single-screen display

Select picture with ▲▼◀▶ and press [MENU/SET]

- Only months when pictures were taken are shown on the calendar screen. Pictures taken without clock settings are displayed with the date 1st January, 2011.
- Pictures displayed with [!] cannot be played back.
- Pictures taken with destination settings of [World Time] are displayed in the calendar screen with appropriate date of the destination's time zone.

Deleting pictures

Playback Mode:

Pictures will be deleted from the card if the card is inserted, or from the built-in memory if the card is not inserted. (Deleted pictures cannot be recovered.)

1 Press to delete the displayed picture

2 Select [Yes]

• Do not turn off the power during deletion.

To delete multiple (up to 50) or all pictures

(after step 1)

2 Select type of deletion

- To use [Delete All] → go to step 5

3 Select the pictures to delete

(Repeat)



- To release → Press [MENU/SET] again

4 Select [OK]

5 Press ◀ to select [Yes], and then press [MENU/SET]

- May take time depending on number of pictures deleted.
- You can select [All Delete Except ★] in [Delete All] if there are pictures that have been set as [Favorite] (→60).

- Use a sufficiently charged battery or an AC adaptor (optional) and DC coupler (optional).
- Pictures cannot be deleted in the following cases:
 - Protected pictures
 - Card switch is in "LOCK" position.
 - Pictures not of DCF standard (→22)

Setting the menu

Refer to the procedure example below when operating the [Setup] menu, [Rec] menu and [Playback] menu.

■ About the menu screen



Buttons used in menu operations

- Ⓐ: [MENU/SET]
- Ⓑ: Cursor button
- Ⓒ: [⏪ / ⏩] (Delete/Return) button

Menu screen configuration

- Ⓓ: Menu description
- Ⓔ: Menu items
- Ⓕ: Operation guide

■ Menu type

[Setup] menu

Making the camera more convenient to use

- Enables you to specify clock settings, sound volume, and so on to make the camera easier to use.

[Rec] menu (Recording Mode only)

Changing picture preferences

- Enables you to specify colour, sensitivity, pixel level, and other settings.

[Playback] menu (Playback Mode only)

Using your pictures

- Enables you to specify picture protection, resizing, and other settings for pictures you have taken.

■ Menu operation flow

Displaying the menu screen

1 Press [MENU/SET]

The menu options screen is displayed.

Selecting the menu type

2 Select [Rec], and press [MENU/SET]

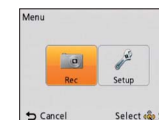

Select the item

3 Press ▲▼ to select [AF Mode], and then press [MENU/SET]

Ⓒ: Pages
The pages can also be selected with the zoom button.



Changing the settings

4 Press ▲▼ to select a setting, and then press [MENU/SET]

The selected setting is set.

- To cancel → Press [⏪ / ⏩]

- Ⓗ: Settings
- Ⓘ: Selected setting

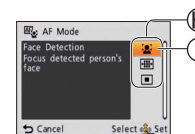

Exiting the menu screen

5 Press [⏪ / ⏩] several times

The menu closes and the monitor returns to the previous screen.

















- The menu types and items that are displayed vary according to the mode.
- The setting methods vary depending on the menu item.
- In Recording Mode, the menu screen can also be exited by pressing the shutter button halfway.





Using the [Setup] menu

For details about the setting procedure in the [Setup] menu. (→26)

For details about the setting procedure in the [Setup] menu. (→26)

[Clock Set], [Auto Review] and [Auto Power Off] are important for clock setting and battery life. Please check these before use.





Item	Settings, Notes
 [Clock Set] (→16)	Set time, date, and display format.
 [World Time] Set the local time at travel destination. (→45)	 [Destination]: Set the local time at travel destination.  [Home]: Set date and time at home area.
 [Beep] Adjust volume of beep sounds.	 /  /  : Low/High/Mute
 [Volume] Adjust volume of sound from speakers (7 levels).	[0] / [1] / [2] / [3] / [4] / [5] / [6] • Cannot be used to adjust TV speaker volume when connected to TV.
 [Focus Icon] Change the focus icon.	 /  /  /  /  / 
 [Auto Power Off] The camera turns off automatically after a specified period of inactivity.	[2 MIN.] / [5 MIN.] / [10MIN.] / [OFF] • To restore → Turn on the power again. • Cannot be used in the following cases: When using AC adaptor (optional) and DC coupler (optional), when connected to computer/printer, during motion picture recording/playback, during Slide Shows, during automatic demo playback • Specific periods apply in the following situations. [Intelligent Auto] Mode: [5 MIN.], and when a Slide Show is paused: [10MIN.]





Item	Settings, Notes
 [Auto Review] Automatically display still pictures immediately after taking them.	[ON] (Automatically displays for 2 seconds.)/ [OFF] • Fixed to [ON] in [Intelligent Auto] Mode. • Auto review occurs immediately after taking still pictures in [Burst] mode, or [Panorama Assist] in Scene Mode, regardless of settings. • Motion pictures cannot be automatically reviewed.
 [Reset] Reset to the default settings.	[Reset Rec. settings?] [Reset setup parameters?] • When [Setup] settings are reset, [Age] setting in [Baby] Scene Mode is also reset. • Folder numbers and clock settings will remain unchanged. • Camera movement may be audible as the lens function is reset. This is normal.
 [Output] Adjust the settings used when the camera is connected to a TV via the AV cable (optional). (Playback Mode only.)	 [Video Out] [NTSC] / [PAL]  [TV Aspect] 16:9 / 4:3

Using the [Setup] menu (Continued)

For details about the setting procedure in the [Setup] menu. (→26)

For details about the setting procedure in the [Setup] menu. (→26)

Item	Settings, Notes
 [Rotate Disp.] Automatically rotate portrait still pictures.	 [OFF] <ul style="list-style-type: none"> • [Rotate Disp.] cannot be used with motion pictures. • Still pictures taken with the lens surface facing up or down, or still pictures taken on other cameras may not rotate. • Pictures cannot be rotated during Multi Playback. • Will only be displayed rotated on computer if in Exif-compatible (→22) environment (OS, software).
 [Version Disp.] Check the version of the camera firmware.	Current version is displayed.
 [Format] Use when [Built-In Memory Error] or [Memory Card Error] appears, or when formatting the built-in memory or card. When a card/built-in memory is formatted, the data cannot be restored. Check the content of the card/built-in memory carefully before formatting.	<ul style="list-style-type: none"> • This requires a sufficiently charged battery, or an AC adaptor (optional) and DC coupler (optional). When formatting the built-in memory, remove the cards. (Only inserted card will be formatted if present; built-in memory will be formatted if no card is inserted.) • Always format cards with this camera. • All protected pictures and other picture data will be deleted. • Do not turn off power or perform other operations during formatting. • Formatting the built-in memory may take several minutes. • Consult the dealer or your nearest Service Centre if format cannot be successfully completed.

Item	Settings, Notes
 [Language] Change display language.	Set the language displayed on the screen.
DEMO [Demo Mode] View demonstration of functions.	[Stabilizer Demo.] Indicates the extent of jitter detected by the camera (Estimate) <div style="display: flex; align-items: center; margin-top: 5px;">  Extent of jitter </div> <div style="display: flex; align-items: center; margin-top: 5px;">  Extent of jitter after stabilization </div> <ul style="list-style-type: none"> • When the demo screen is displayed, press [MENU/SET] to switch the Optical Image Stabilizer between on and off. • To cancel → Press .
	[Auto Demo]: View introductory Slide Show [ON]/[OFF] <ul style="list-style-type: none"> • To cancel → Press . • When a card is not inserted, Automatic Demo Mode will start if there is no operation for about 2 minutes with the power on, connected to the AC adaptor (optional) and DC coupler (optional). • [Auto Demo] cannot be displayed on external devices such as TVs.

Taking pictures with your own settings

[Normal Picture] Mode

Recording Mode:

Using the [Rec] menu to change settings and set up your own recording environment.

Shutter button

- 1 Display the screen for Recording Mode selection**
- 2 Select [Normal Picture] Mode**

 Cancel Select Set
- 3 Take a picture**

 Press halfway (press lightly to focus) →
 Press fully (press the button all the way to record)

Recording Mode list

	[Intelligent Auto] Mode	Take pictures with automatic settings.	(→18)
	[Normal Picture] Mode	Take pictures with your own settings.	-
	[Scene Mode]	Take pictures according to scene.	(→39)
	[Motion Picture] Mode	Take motion pictures.	(→21)

- If a warning is displayed about jitter, use [Stabilizer], a tripod, or [Selftimer].
- If aperture value or shutter speed is displayed in red, correct exposure has not been achieved. Use flash or change [Sensitivity] settings.

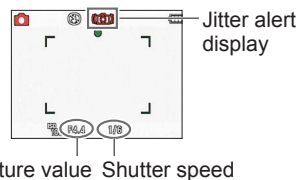

Aligning the focus

Useful when subject is not in the centre of picture.

1 First adjust focus according to subject

Align the AF area with the subject

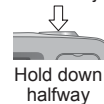

Focus display

(When focus is aligned: illuminated
When focus is not aligned: flashing)

AF area

(When focus is aligned: green
When focus is not aligned: red)

2 Return to desired composition

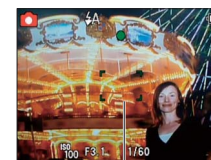
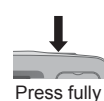

- Subjects/environments which may make focusing difficult:

- Fast-moving or extremely bright objects, or objects with no colour contrast.
- Taking pictures through glass or near objects emitting light. In the dark, or with significant jitter.
- When too close to object or when taking pictures of both distant and close objects together in the same picture.

Focus range

Distance between the lens and the subject

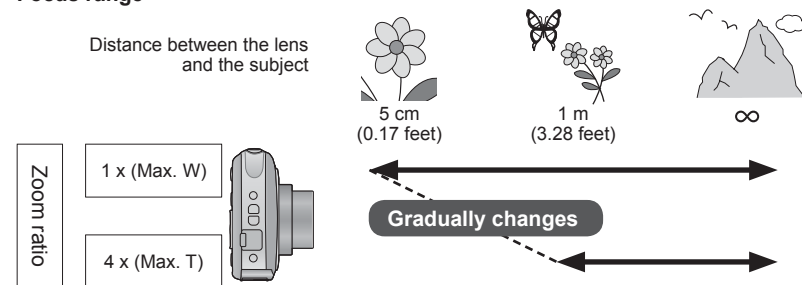

- The focus display flashes and beep sounds when focus is not aligned. Use the focus range displayed in red as a reference. Even if the focus display is lit, the camera may be unable to bring the subject into focus if it is out of range.
- AF area is displayed larger in dark conditions or when using Digital Zoom.



Focus range

Changing recording information display

You can switch between various information shown on the LCD monitor, such as guide lines and recording information.

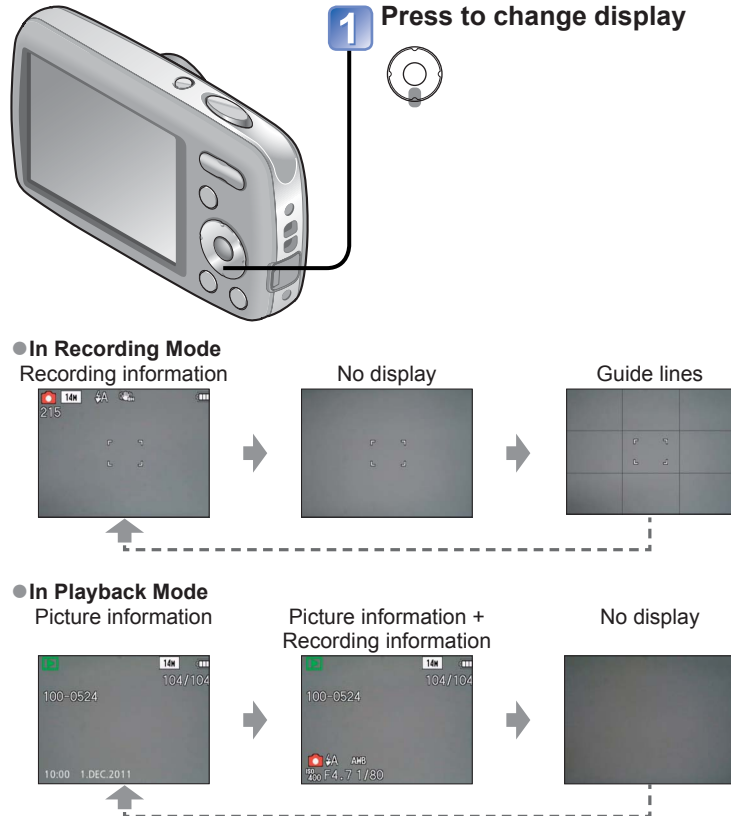

■ Guide lines

- Reference for composition (e.g. balance) when recording.
- For motion picture or Slide Show playback, the operational guidance information is either displayed or not displayed on the LCD monitor.

Taking pictures with the self-timer

Recording Mode: SCN

We recommend using a tripod. This is also effective for correcting jitter when pressing the shutter button, by setting the self-timer to 2 seconds.

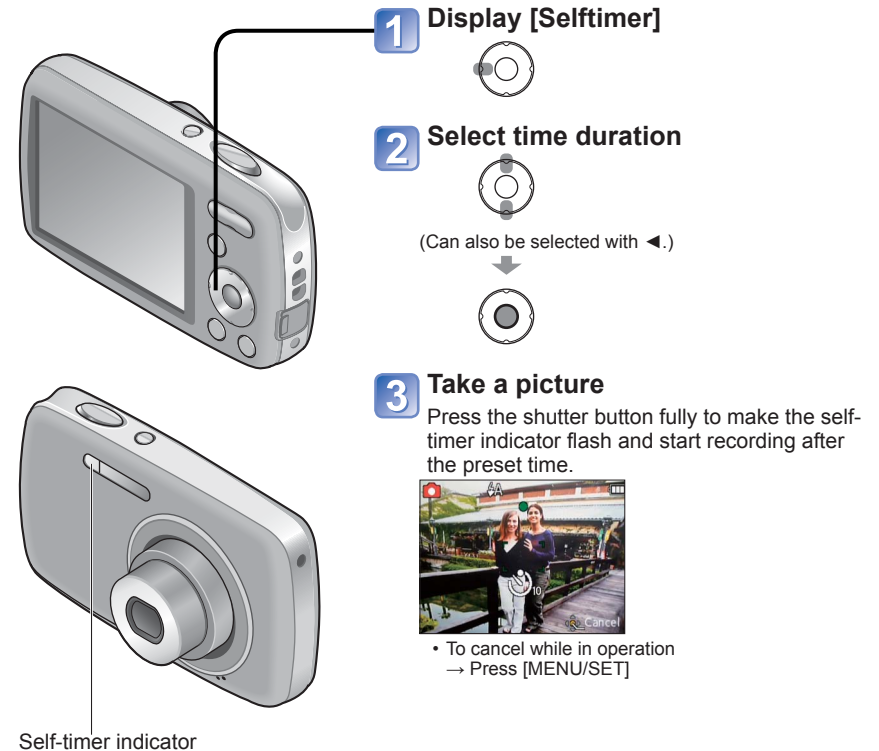

- Focus will be automatically adjusted immediately before recording if shutter button is pressed fully.
- After self-timer lamp stops flashing, it may then be lit for AF Assist Lamp.
- In [Self Portrait] Scene Mode, [10sec.] is unavailable.

Taking pictures with flash

Recording Mode:

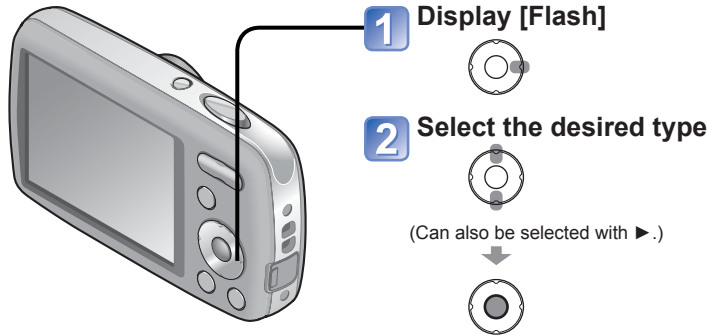

Type, operations	Uses
[Auto] • Automatically judges whether or not to flash	Normal use
[Auto/Red-Eye] *1, *2 • Automatically judges whether or not to flash (reduce red-eye)	Taking pictures of subjects in dark places
[Forced Flash On] • Always flash	Taking pictures with backlight or under bright lighting (e.g. fluorescent)
[Forced On/Red-Eye] *1, *2 • Always flash (reduce red-eye)	Taking pictures of subjects against a nightscape (tripod recommended)
[Slow Sync./Red-Eye] *1, *2 • Automatically judges whether or not to flash (reduce red-eye; slow shutter speed to take brighter pictures)	Places where flash use is prohibited
[Forced Flash Off] • Never flash	

*1 The flash is activated twice. Be sure to stop moving before the second flash. Note that the interval of flashes varies depending on the subject brightness.

*2 When [Red-Eye Removal] is activated in the Recording menu, the icon is displayed, red-eye is automatically detected, and the still picture data is corrected. (Only when [AF Mode] is set to (Face Detection).) (DMC-S3 only)

● Shutter speeds are as follows:

- : 1/60 - 1/1600th
- : 1/8*3 - 1/1600th

*3 Max. 1/4 sec. when [ISO] in [Sensitivity] is set; max. 1 sec. when [Stabilizer] is set to [OFF] or when blur is insignificant. Also varies according to [Intelligent Auto] Mode, [Scene Mode] scene, etc.

● The effect of Red-Eye Reduction varies depending on the subject and is affected by factors such as distance to the subject, whether the subject is looking at the camera during preliminary flash, and so on. In some cases, the effect of Red-Eye Reduction may be negligible.

Available types in each mode

(○: Available, -: Not available, ◻: Default setting)

		iA	[Scene Mode]															
	○	○*4	○	○	○	○	○	○	○	○	○	○	○	○	○	○	○	○
	○	-	○	○	○	-	-	-	-	○	-	-	-	-	-	-	-	-
	○	-	○	○	○	○	-	-	-	○	○	○	○	○	○	○	○	○
	-	-	-	-	-	-	-	-	-	○	-	-	-	-	-	-	-	-
	-	-	-	-	-	-	-	-	-	○	-	-	-	-	-	-	-	-
	○	○	○	○	○	○	○	○	○	○	○	○	○	○	○	○	○	○

*4 Set to , , or according to the subject and brightness.

- The flash cannot be used in Motion Picture Mode and in these Scene Modes: , , , .
- Scene Mode flash settings are restored to default when Scene Mode is changed.

The available flash range when [Sensitivity] setting is ISO

W side (Max.)	Approx. 40 cm (1.32 feet) - 3.3 m (10.8 feet)
T side (Max.)	Approx. 1.0 m (3.28 feet) - 1.6 m (5.24 feet)

- Do not touch or look at the flash (→7) from close distances (i.e. a few cm). Do not use the flash at close distances to other subjects (heat/light may damage subject).
- Flash settings may be changed when changing Recording Mode.
- When [ISO] is set in [Sensitivity], the ISO Sensitivity is automatically set in a range up to 1600.
- No pictures may be taken if these marks (e.g.) are flashing (flash is charging).
- Insufficient light may prevent appropriate exposure or white balance.
- Flash effect may not be fully achieved with high shutter speeds.
- Flash charging may take time if battery is low, or if using flash repeatedly.

Taking pictures with Exposure Compensation

Recording Mode: SCN

Corrects exposure to obtain optimum exposure (for example, if there is difference between brightness of object and background). Depending on the brightness, this may be impossible in some cases.

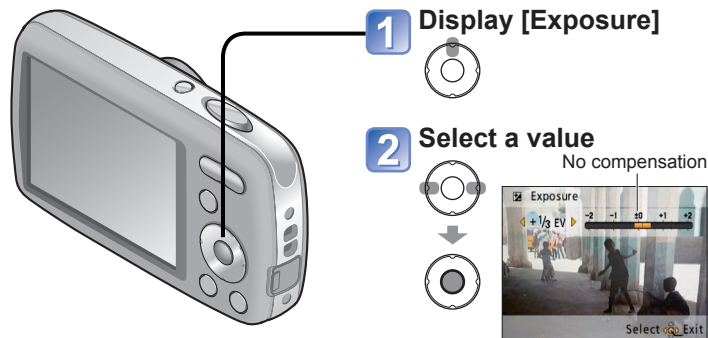

- After exposure adjustment, the adjustment value (+1/3 for example) is displayed.
- The Exposure Compensation value you set is retained even after the camera is turned off.

Taking pictures according to the scene

[Scene Mode]

Recording Mode: SCN

Using [Scene Mode] enables you to take pictures with optimum settings (exposure, colouring, etc.) for given scenes.

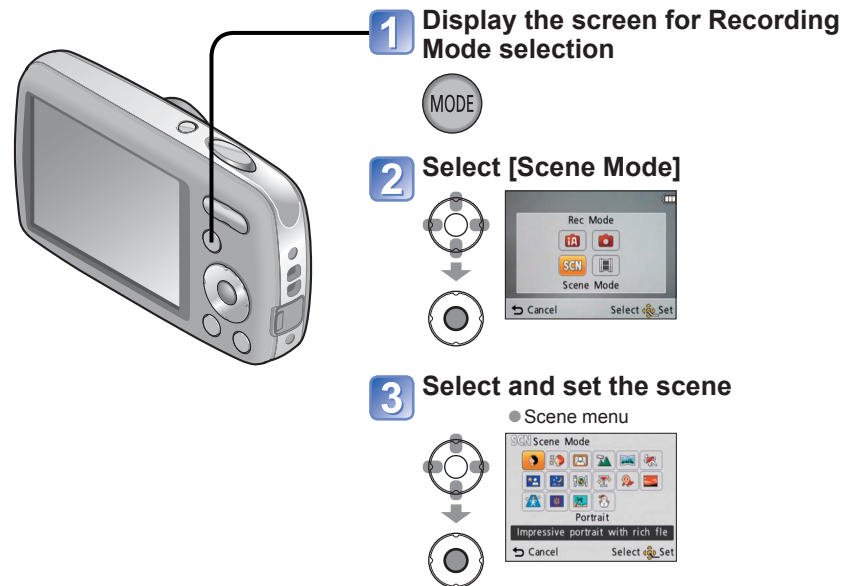

- Selecting a Scene Mode inappropriate for the actual scene may affect the colouring of your picture.
- The following [Rec] menu settings will be automatically adjusted and prevents manual selection (available settings vary according to scene setting): [Sensitivity], [Color Mode]
- [White Balance] can only be set in the following scenes. [Portrait], [Soft Skin], [Self Portrait], [Panorama Assist], [Sports], [Baby], [High Sens.] (Setting is restored to [AWB] when scene is changed.)
- The types of flash available (→37) vary according to the scene. The Scene Mode flash setting is reset to the default setting when the Scene Mode is changed.





Taking pictures according to the scene





[Scene Mode] (Continued)

Recording Mode: SCN

How to select a scene. (→39)

Using flash in Scene Modes. (→37)

Scene	Uses, Tips	Notes
 [Portrait]	<p>Improves the skin tone of subjects for a healthier appearance in bright daylight conditions.</p> <p>Tips</p> <ul style="list-style-type: none"> Stand as close as possible to subject. Zoom: As telescopic as possible (T side) 	-
 [Soft Skin]	<p>Smooths skin colours in bright, outdoor daylight conditions (portraits from chest upwards).</p> <p>Tips</p> <ul style="list-style-type: none"> Stand as close as possible to subject. Zoom: As telescopic as possible (T side) 	<ul style="list-style-type: none"> Clarity of effect may vary depending on brightness. If a part of the background etc. is a colour close to skin colour, this part is also smoothed.
 [Self Portrait]	<p>Take pictures of yourself.</p>  <p>Tips</p> <ul style="list-style-type: none"> Press shutter button halfway → self-timer indicator illuminates → press shutter button fully → review (if self-timer indicator flashes, focus is not correctly aligned) Avoid zoom (harder to focus). 2-second self-timer recommended. 	-
 [Scenery]	<p>Takes clear pictures of wide, distant subjects.</p>	-

Scene	Uses, Tips	Notes
 [Panorama Assist]	<p>Use the supplied software to join multiple pictures into a single panorama picture.</p> <ol style="list-style-type: none"> Use ▲▼ to select the recording direction, and press [MENU/SET] to set. Special panorama guidelines will be displayed. Take the picture.  <ol style="list-style-type: none"> Select [Next], and press [MENU/SET] to set. <ul style="list-style-type: none"> Alternatively, press the shutter button. You can take pictures again by selecting [Retake]. Change the composition and take the picture so that a part of the picture overlaps with the previous picture.  <p>Section of picture that was taken last time</p> <ol style="list-style-type: none"> After you finish taking pictures, select [Exit], and press [MENU/SET] to set. <p>Tips</p> <ul style="list-style-type: none"> Keep your recording location. Use a tripod. 	<ul style="list-style-type: none"> The focus, zoom, Exposure Compensation, White Balance, shutter speed, and ISO Sensitivity are all fixed at the setting for the first picture. When the camera is set to [Stabilizer] and there is very little jitter, or if [Stabilizer] is set to [OFF], shutter speed may slow down up to 8 seconds. Shutter may remain closed for up to 8 seconds after taking picture. Panorama picture stitching cannot be performed by this camera. Use the software on the supplied CD-ROM "PHOTOfunSTUDIO" to make the pictures you record into a panorama still picture with your computer.
 [Sports]	<p>Takes pictures of scenes with fast movement, e.g. sports.</p> <p>Tips</p> <ul style="list-style-type: none"> Stand at least 5 m (16.4 feet) away. 	<ul style="list-style-type: none"> When the camera is set to [Stabilizer] and there is very little jitter, or if [Stabilizer] is set to [OFF], shutter speed may slow down up to 1 second.





Taking pictures according to the scene









[Scene Mode] (Continued)

Recording Mode: SCN

How to select a scene. (→39)

Using flash in Scene Modes. (→37)



Scene	Uses, Tips	Notes
 [Night Portrait]	<p>Takes pictures of people and nightscapes with close to actual brightness.</p> <p>Tips</p> <ul style="list-style-type: none"> Use flash. Subject should keep still. Tripod, self-timer recommended. 	<ul style="list-style-type: none"> When the camera is set to [Stabilizer] and there is very little jitter, or if [Stabilizer] is set to [OFF], shutter speed may slow down up to 1 second (or up to 8 seconds if flash is set to  (Forced Flash Off). Interference may be noticeable with dark scenes. Shutter may remain closed for up to 8 seconds after taking picture.
 [Night Scenery]	<p>Takes clear pictures of night scenes.</p> <p>Tips</p> <ul style="list-style-type: none"> Tripod, self-timer recommended. 	<ul style="list-style-type: none"> When the camera is set to [Stabilizer] and there is very little jitter, or if [Stabilizer] is set to [OFF], shutter speed may slow down up to 8 seconds. Interference may be noticeable with dark scenes. Shutter may remain closed for up to 8 seconds after taking picture.
 [Food]	<p>Takes natural-looking pictures of food.</p>	-
 [Party]	<p>Brighten subjects and background in pictures of indoor events, such as weddings.</p> <p>Tips</p> <ul style="list-style-type: none"> Stand approx. 1.5 m (4.92 feet) away. Zoom: Wide (W side) Use flash. Tripod, self-timer recommended. 	-

Scene	Uses, Tips	Notes
 [Baby]	<p>Uses weak flash to bring out skin colours.</p> <ul style="list-style-type: none"> To record age <ol style="list-style-type: none"> Select [Age], and press [MENU/SET]. Select [Set] with , and press [MENU/SET]. Set birthday with , , and press [MENU/SET]. Select [Exit] with , and press [MENU/SET]. <p>Tips</p> <ul style="list-style-type: none"> Make sure [Age] is [ON] before taking a picture. 	<ul style="list-style-type: none"> Age will be displayed for approx. 5 seconds after setting this mode. When the camera is set to [Stabilizer] and there is very little jitter, or if [Stabilizer] is set to [OFF], shutter speed may slow down up to 1 second.
 [Sunset]	<p>Takes clear pictures of scenes such as sunsets.</p>	-
 [High Sens.]	<p>Prevents blurring of subject in dark, indoor conditions.</p> <p>Select the aspect ratio and the picture size with   and press [MENU/SET].</p>	-

Taking pictures according to the scene

[Scene Mode] (Continued)

Recording Mode: SCN

Scene	Uses, Tips	Notes
 [Fireworks]	Takes clear pictures of fireworks in the night sky. Tips • Stand at least 10 m (32.8 feet) away. • Tripod recommended.	• The shutter speed becomes 1/4 second, or 2 seconds (if there is a little jitter or if Optical Image Stabilizer is off). (Shutter speed can be changed by correcting exposure.)
 [Beach]	Brings out the clear blues of the sky and the sea without darkening subject.	• Do not touch camera with wet hands. • Beware of sand and sea water.
 [Snow]	Brings out the natural colour of snow in ski slope and mountain scenes.	—

Useful features for travel [World Time]

Recording Mode: *  SCN 

* Recording only. (Cannot set.)

You can adjust the time to match the local time at your destination.

Set-up: • Clock must be set in advance (→16).

• Press [MENU/SET] →  [Setup] menu → Select [World Time]

[Please set the home area] will be displayed when setting for the first time. In this case, press [MENU/SET] and skip to step 2.



■ Set home area

1 Select [Home]

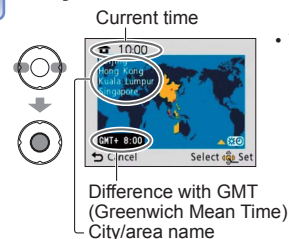

2 Set your home area



• To cancel
→ Press
 / .



■ Set destination area

1 Select [Destination]

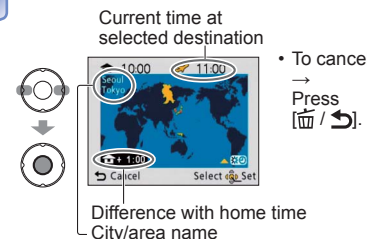

2 Set destination area



• To cancel
→ Press
 / .

If actual destination is unavailable, select based on "difference with home time".

■ Upon your return

Go through steps 1 and 2 on the upper left, and return to the original time.

■ To set/release summer time



Press ▲ in step 2. (Press again to release)

- When summer time is set, the current time is advanced by 1 hour. If the setting is cancelled, the time automatically returns to the current time.
- Still pictures and motion pictures recorded after you have specified the destination are labeled  (destination) during playback.

Using the [Rec] menu

For details about the setting procedure in the [Rec] menu (→26)

For details about the setting procedure in the [Rec] menu (→26)

[Picture Size]

Set the size (number of pixels) of still pictures. This setting determines how many pictures you can record.

■ **Mode:** SCN

■ **Settings:**

DMC-S3

Recording pixel level type		
	14 M	4320×3240
	10 M	3648×2736
	5 M	2560×1920
	3 M	2048×1536
	0.3 M	640×480
	12.5 M	4320×2880
	10.5 M	4320×2432

DMC-S1

Recording pixel level type		
	12 M	4000×3000
	8 M	3264×2448
	5 M	2560×1920
	3 M	2048×1536
	0.3 M	640×480
	10.5 M	4000×2672
	9 M	4000×2248

* This setting is not available in ([Intelligent Auto] Mode).

- represent the aspect ratios of the still pictures.
- Extra Optical Zoom can be used for picture sizes indicated with .
- Extra Optical Zoom is not available in the following cases.
 - [Motion Picture] Mode
 - [High Sens.] in Scene Mode
- Mosaic effect may appear depending on subject and recording conditions.

Setting guide

Larger Picture Size	←→	Smaller Picture Size
Sharper picture		Coarser picture
Lower recording capacity		Higher recording capacity

[Rec Quality]

Set the picture size of motion pictures.

■ **Mode:**

■ **Settings:**

Picture Quality	Picture Size	No. of Frames	Picture Aspect Ratio
	1280 × 720 pixels	30 fps	16:9
	640 × 480 pixels		4:3
	320 × 240 pixels		

*[QVGA] is fixed when recording to the built-in memory.

- Depending on the motion picture recording environment, static electricity or electromagnetic waves may cause the screen to go black momentarily or noise to be recorded.
- When recording motion pictures, it is recommended to use a sufficiently charged battery or an AC adaptor (optional) and DC coupler (optional).
- When recording motion pictures using an AC adaptor, if you unplug the AC adaptor or a power outage occurs, power to the camera is cut, and the motion picture in progress is no longer recorded.
- If you attempt to play motion pictures recorded with the camera on other devices, playback may not be possible, or the picture or sound quality may be poor. Additionally, incorrect recording information may be indicated.

[Sensitivity]

Set ISO Sensitivity (sensitivity to lighting) manually. We recommend higher settings to take clear pictures in darker locations.

■ **Mode:**

■ **Settings:** [ISO] (Intelligent ISO) / [100] / [200] / [400] / [800] / [1600]

Setting guide

[Sensitivity]	[100]	←→	[1600]
Location (recommended)	Bright (outdoors)		Dark
Shutter speed	Slow		Fast
Interference	Low		High
Jitter of the subject	Increased		Less

- [ISO] is automatically set in a range up to 1600 based on subject movement and brightness.
- Scope of flash recording (→37)

Using the [Rec] menu (Continued)

For details about the setting procedure in the [Rec] menu (→26)

[White Balance]

Adjust colouring to suit light source if colours otherwise appear unnatural.

■ **Mode:** SCN

■ **Settings:** [AWB] (automatic) / (outdoor, clear sky) / (outdoor, cloudy sky) / (outdoor, shade) / (incandescent lighting) / (uses value set in SET) / SET (set manually)

[AWB] operational range:

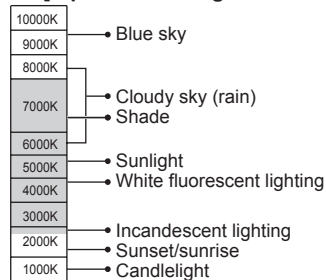

K=Kelvin colour Temperature

- Picture may appear red or blue if out of range. This function may also not work correctly even within the range if there are many light sources present.
- We recommend setting to [AWB] or SET when under fluorescent lighting.

■ **Setting White Balance manually** (SET)

- ① Select SET and press [MENU/SET].
- ② Point the camera towards a white object (e.g. paper) and press [MENU/SET].
- ③ Press [MENU/SET].
 - White Balance is set to .
 - The White Balance you set is retained even after the power is turned off.
 - White Balance setting may not be possible if the subject is too bright or too dark. In such cases, adjust the subject to an appropriate brightness, and then set the White Balance again.

Only takes picture of white objects within frame (step ②)

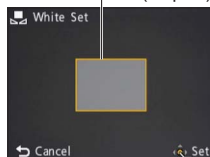

[AF Mode]

Method of aligning focus can be changed according to position and number of subjects.

■ **Mode:** SCN

■ **Settings:** / /

<p>Taking front-on pictures of people</p> <p> (Face Detection)</p>	<p>Detected faces (up to 15 people) and adjusts exposure and focus accordingly.</p>  <p>AF area Yellow: When the shutter button is pressed halfway, the frame turns green when the camera is focused. White: Displayed when more than one face is detected. Other faces that are the same distance away as faces within the yellow AF area are also focused.</p>
<p>Subject not centred in picture (AF area displayed only when focused)</p> <p> (11-area-focusing)</p>	<p>Automatically focuses on any of 11 points.</p>
<p>Determined position for focus</p> <p> (1-area-focusing)</p>	<p>Focuses on AF area in centre of picture. (Recommended when focus is difficult to align)</p>

- AF area becomes larger in dark locations or when using Digital Zoom, etc.
- In [Fireworks] Scene Mode, the AF mode setting is fixed to .
- Cannot set to "Face Detection" in the following cases: [Panorama Assist], [Night Scenery], [Food] Scene Modes
- If the camera misinterprets a non-human subject as a face in the "Face Detection" setting, switch to another setting.
- If faces cannot be detected such as when subjects are looking at places other than the camera or when the subject is moving rapidly, the AF mode setting switches to .

Using the [Rec] menu (Continued)

For details about the setting procedure in the [Rec] menu (→26)

[Digital Zoom]

Multiplies effect of Optical Zoom or Extra Optical Zoom by up to 4 times.

■ **Mode:** SCN

■ **Settings:** [ON]/[OFF]

Digital Zoom area is displayed within zoom bar on screen.

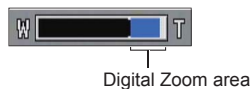

- Zoom motion stops momentarily when entering Digital Zoom range.
- Within Digital Zoom range, AF area is displayed larger when the shutter button is pressed halfway.
- We recommend using a tripod and [Selftimer].

- The setting is fixed to [OFF] in [High Sens.] Scene Mode.
- Cannot change the setting in [Motion Picture] Mode. The setting in other Recording Mode is applied.

[Burst]

Enables a rapid succession of still pictures to be taken. Succession of still pictures taken while shutter button is held down.

■ **Mode:** IA SCN

■ **Settings:** / [OFF]

	Speed	No. of pictures
DMC-S3	Approx. 2 pictures/sec	Until card/built-in memory is full
DMC-S1	The burst speed differs according to the writing speed of the card and picture size.	

- Focus is fixed from first picture. Exposure and White Balance is adjusted for each picture.
- Burst speed may be reduced if ISO Sensitivity is set to high, or if shutter speed is reduced in darker locations.
- When burst is selected, the flash is disabled.
- When you record subjects in motion where there is a significant difference between light and dark areas, it may not be possible to achieve the optimal exposure.
- The setting is fixed to [OFF] in [Panorama Assist] and [Fireworks] Scene Modes.

[Color Mode]

Set colour effects.

■ **Mode:** IA SCN E

■ **Settings:** [STANDARD] / [NATURAL] (soft) / [VIVID] (sharp) / [B/W] / [SEPIA] / [COOL] (more blue) / [WARM] (more red)

- If interference is noticeable in dark locations: Set to [NATURAL].
- In IA ([Intelligent Auto] Mode), [STANDARD], [B/W], and [SEPIA] can only be set.

[AF Assist Lamp]

Illuminates lamp when dark to facilitate focus alignment.

■ **Mode:** SCN

■ **Settings:** [ON]: Lamp illuminated with halfway press of shutter button (and larger AF area displayed)
[OFF]: Lamp off (taking pictures of animals in dark, etc.)

- The AF Assist Lamp has an effective distance of 1 m (3.28 feet).
 - Do not block the lamp with your fingers or look at it from close range.
 - The AF Assist Lamp's effective distance becomes shorter when using the zoom and depending on subject conditions.
- The setting is fixed to [OFF] in the following Scene Modes. [Self Portrait], [Night Scenery], [Scenery], [Sunset], [Fireworks]
- Cannot change the setting in [Motion Picture] Mode. The setting in other Recording Mode is applied.

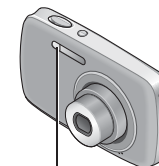

AF Assist Lamp

[Red-Eye Removal] (DMC-S3 only)

Automatically detects red-eye and corrects still picture data when recording with flash Red-Eye Reduction ().

■ **Mode:** SCN

■ **Settings:** [ON]/[OFF]

- Available only when [AF Mode] is set to (Face Detection).
- The red-eye effect may not be corrected under certain conditions.
- When [ON] is selected, is displayed in the flash icon.

Using the [Rec] menu (Continued)

[Stabilizer]

Automatically detects and prevents jitter.

■ **Mode:**  SCN

■ **Settings:** [ON]/[OFF]

- The setting is fixed to [ON] in [Self Portrait] Scene Mode.
- Cases where Optical Image Stabilizer may be ineffective:
Heavy jitter, high zoom ratio (also in the Digital Zoom range), fast-moving objects, indoors or in dark locations (due to low shutter speed)

[Date Stamp]

Stamps the recording date on still pictures, in the date format set in [Clock Set].

■ **Mode:**  SCN

■ **Settings:** [W/O Time]/[With Time]/[OFF]

- Date stamps on still pictures cannot be erased.
- The date is not stamped when [Burst] is set or when [Panorama Assist] is set in Scene Mode.
- Do not request date printing in store or make date printing on printer for still pictures with date stamps. (Date printing may be overlapping.)
- Cannot change the setting in [Intelligent Auto] Mode. The setting in other Recording Mode is applied.

[Clock Set]



Set the clock (→16). Same function as that in [Setup] menu.

Different playback methods (Playback Mode)

Playback Mode: 

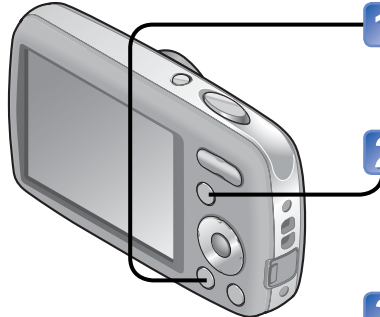
Recorded pictures can be played back in a variety of ways.



- 1 Press the Playback button**

- 2 Display the screen for Playback Mode selection**

- 3 Select the method of playback**

- **[Normal Play]**
(→22)
- **[Slide Show]**
(→54)
- **[Filtering Play]**
(→55)
- **[Calendar]**
(→55)

- When no card is inserted, pictures are played back from the built-in memory.
- After you switch from Recording Mode to Playback Mode, the Playback Mode automatically becomes [Normal Play].

Different playback methods (Playback Mode)

(Continued)

Playback Mode: ▶

For details about the switching Playback Mode procedure (→53)

[Slide Show]

Automatically plays back still pictures in order and to music. Recommended when viewing on TV screen.

1 Select playback method

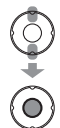

[All]	Playback of all still pictures
[Category Selection]	Select a category and play back. (Select category with ▲▼▶◀ and press [MENU/SET].) (→55)
[Favorite]	Display pictures set as [Favorite].

2 Set playback effects



[Effect] (Select music and effects according to picture atmosphere)		[Setup]	
[AUTO]	Only available with [Category Selection] setting	[Duration]	[1 SEC.] / [2 SEC.] / [3 SEC.] / [5 SEC.] (Only available when [Effect] is [OFF])
[NATURAL]	Playback with relaxed music and screen transition effects	[Repeat]	[ON]/[OFF]
[SLOW]	Playback with livelier music and screen transition effects	[Music]	[ON]: The audio portion is played to match effects. [OFF]: The audio portion is not played.
[SWING]	Playback with livelier music and screen transition effects		
[URBAN]	Playback with livelier music and screen transition effects		
[OFF]	No effects		

3 Select [Start] with ▲ and press [MENU/SET]

- Press [⏏] / [↵] to return to menu screen during Slide Show.

■ Operations during Slide Show

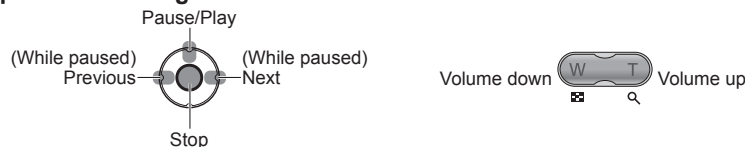

- When [URBAN] has been selected, the picture may appear in black and white as a screen effect.
- When a picture is displayed that was recorded in portrait orientation, some [Effect] items do not operate.
- Music effects cannot be added.
- Motion pictures cannot be played back in a Slide Show. When the [Motion Picture] category is selected, the initial screens of motion pictures are played back as still pictures in the Slide Show.

[Filtering Play]

You can narrow down the pictures displayed to view only a selected category or your favourite pictures.

1 Select the method to narrow down the displayed pictures



[Category Selection]	Display only pictures in the selected category.
[Favorite]	Display pictures set as [Favorite].

2 When [Category Selection] has been selected in step 1, select a category



[Category]	Recording information such as Scene Modes
	[Portrait] / / [Soft Skin] / [Self Portrait] / [Night Portrait] / / [Baby]
	[Scenery] / / [Sunset] /
	[Night Portrait] / / [Night Scenery] /
	[Sports] / [Party] / [Fireworks] / [Beach] / [Snow]
	[Baby]
	[Food]
	[Motion Picture]

[Calendar]

Select the date from the calendar screen to view only the pictures taken on that day (→24).

Using the [Playback] menu

Playback Mode: 

You can edit recorded pictures, such as setting a picture to be uploaded to image-sharing websites, reducing the picture size, setting write-protect, etc.

For details about the setting procedure in the [Playback] menu (→26)

[Upload Set]

You can select pictures on the camera for uploading to image-sharing websites (Facebook or YouTube).

- Only still pictures can be uploaded to Facebook and only motion pictures can be uploaded to YouTube.
- Pictures on the built-in memory cannot be set. Copy pictures to a card (→62) before making [Upload Set] settings.

Set-up: Press [MENU/SET] → [Playback] menu → Select [Upload Set]

1 Select [SINGLE] or [MULTI]

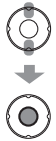

2 Select picture and make setting



3 When [MULTI] has been selected in step 1, select [OK]



4 Press ◀ to select [Yes], and then press [MENU/SET]

For details about the setting procedure in the [Playback] menu (→26)

■ Uploading to image-sharing websites

When setting [Upload Set], the built-in uploading tool automatically makes copies on the card inside the camera. Connect the camera to your computer (→63) before performing uploading operations. For more details, refer to (→65).

■ To clear all

Select [CANCEL] in step 1 and select [Yes].

- May not be compatible with pictures taken on other devices.
- Not available on cards with less than 512 MB.

Using the [Playback] menu (Continued)

Playback Mode:

For details about the setting procedure in the [Playback] menu (→26)

[Resize]

Picture size can be reduced to facilitate e-mail attachment and use in webpages, etc. (Still pictures recorded at the smallest recording pixel level cannot be further reduced.)

Set-up: Press [MENU/SET] → [Playback] menu → Select [Resize]

■ [SINGLE]

1 Select [SINGLE]

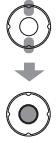

2 Select still picture

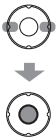

3 Select size

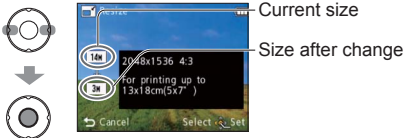

4 Select [Yes]

• After confirmation, press / to return to the menu screen.



■ [MULTI]

1 Select [MULTI] in step 1 on the previous page

2 Select size



3 Select still picture (up to 50 pictures)



• To cancel → Press [MENU/SET] again.

4 Select [OK]



5 Select [Yes]



- Picture quality is reduced after resizing.
- You cannot resize motion pictures, or still pictures that have been taken with [Date Stamp]. May not be compatible with still pictures taken on other devices.

Using the [Playback] menu (Continued)

Playback Mode:

For details about the setting procedure in the [Playback] menu (→26)

[Favorite]

By labeling your favourite pictures with a star (★), you can enjoy [Slide Show] or [Filtering Play] of these pictures only, or you can delete all pictures except your favourites.

Set-up: Press [MENU/SET] → [Playback] menu → Select [Favorite]

1 Select [SINGLE] or [MULTI]

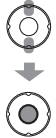

2 Select picture and make setting

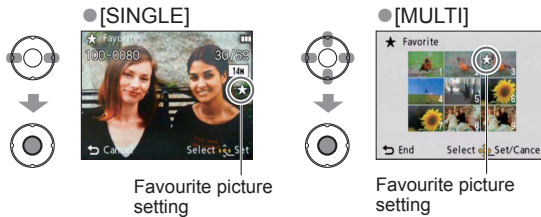

- Up to 999 pictures can be selected.
- To cancel → Press [MENU/SET] again.
- After confirmation, press / to return to the menu screen.

■ To clear all

Select [CANCEL] in step 1 and select [Yes].

- Cannot be set in [Favorite] of [Filtering Play] Playback Mode.
- May not be compatible with still pictures taken on other devices.

[Protect]

Set protection to disable picture deletion. Prevents deletion of important pictures.

Set-up: Press [MENU/SET] → [Playback] menu → Select [Protect]

1 Select [SINGLE] or [MULTI]



2 Select picture and make setting



- To cancel → Press [MENU/SET] again.
- After confirmation, press / to return to the menu screen.

■ To clear all

Select [CANCEL] in step 1 and select [Yes].

■ To cancel while releasing all

Press [MENU/SET].

- May not be effective when using other devices.
- Formatting will cause even protected files to be deleted.
- If the write-protect switch is set to "LOCK," pictures on the card cannot be deleted even if they are not protected with the camera setting.

Using the [Playback] menu (Continued)

Playback Mode: ▶

[Copy]

You can copy pictures between built-in memory and memory card.

Set-up: Press [MENU/SET] → [Playback] menu → Select [Copy]

1 Select the copy method (direction)

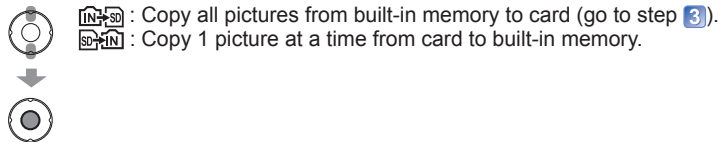

- : Copy all pictures from built-in memory to card (go to step 3).
- : Copy 1 picture at a time from card to built-in memory.

2 When selecting or , press ◀▶ to select a picture, and then press [MENU/SET]

3 Select [Yes]

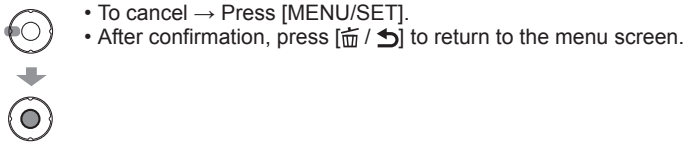

- To cancel → Press [MENU/SET].
- After confirmation, press / to return to the menu screen.

- Copying pictures may take several minutes. Do not turn off power or perform other operations during copying.
- If identical names (folder/file numbers) are present in the copy destination, a new folder for copying will be created when copying from built-in memory to card (). Identically-named files will not be copied from card to built-in memory ().
- The following settings will not be copied. Set them again after copying. [Favorite], [Protect]
- Only pictures from Panasonic digital cameras (LUMIX) may be copied.

Using with your PC

Pictures and motion pictures can be imported from the camera to your computer by connecting the two together.

- If your computer does not support SDXC Memory Cards, a message will be displayed requesting you to format the card. (Do not format the card. This will erase recorded pictures.) If the card is not recognised, refer to the following support website: <http://panasonic.net/avc/sdcard/information/SDXC.html>

Getting Ready:

- Charge the battery sufficiently. Or, connect the AC adaptor (optional) and DC coupler (optional).
- When importing pictures from the built-in memory, remove any memory cards.

Check socket direction and insert straight in.
(Damage to socket shape can lead to faulty operation.)

[Access]
(sending data)
• Do not disconnect the USB connection cable while [Access] is displayed.

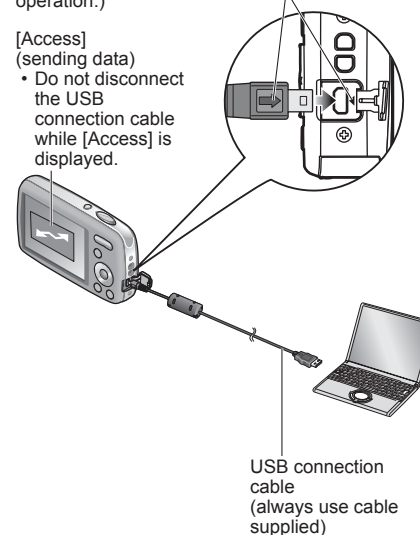

1 Turn on power of both camera and computer

2 Connect camera to computer

- Please make sure you use the supplied USB connection cable. Use of cables other than the supplied USB connection cable may cause malfunction.

3 Select [PC] on the camera



4 Operate with your computer

■ To cancel connection

Click “Safely Remove Hardware” in the Windows System Tray → disconnect USB connection cable → turn off camera power → disconnect AC adaptor

Using with your PC (Continued)

You can save pictures to use on your computer by dragging and dropping folders and files into separate folders on your computer.

■ Folder and file names on computer

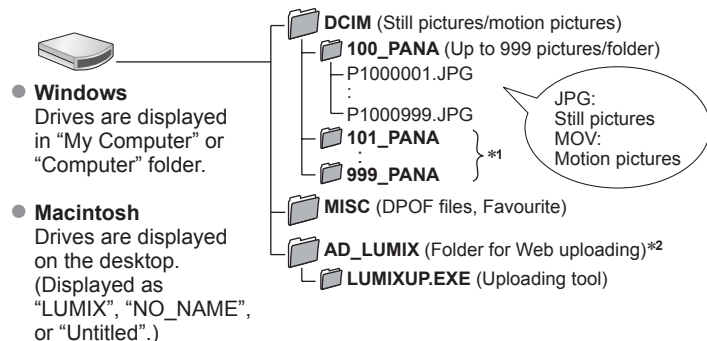

*1 New folders are created in the following cases:

- When pictures are added to folders containing files numbered 999.
- When using cards already containing the same folder number (for example, pictures taken with other cameras, etc.)

*2 Note that if files in the AD_LUMIX folder or its subfolders are deleted, pictures cannot be uploaded to image-sharing websites.

■ When using Windows XP, Windows Vista, Windows 7, or Mac OS X

The camera can be connected to your computer even if you select [PictBridge(PTP)] in the step 3 on the previous page.

- Only picture output can be performed from the camera. (Picture deletion can also be performed with Windows Vista and Windows 7.)
- It may not be possible to import if there are 1000 or more pictures on the card.

- Do not use any other USB connection cables except the one supplied.
- Turn off power before inserting or removing memory cards.
- When the battery begins to run out during communication, warning beep sounds. Cancel communication via your computer immediately. Use a sufficiently charged battery or an AC adaptor (optional) and DC coupler (optional).
- Some computers can read directly from the camera’s memory card. For details, see the manual for your computer.
- For more details, consult your computer operating manual.

Using “PHOTOfunSTUDIO” to copy pictures to your computer

After importing pictures to your computer, you can print or e-mail them.

- Read the separate operating instructions for more information about the operating environment and the installation.

Uploading pictures to image-sharing websites

Using the uploading tool (LUMIX Image Uploader), you can upload still pictures and motion pictures to image-sharing websites (Facebook or YouTube). There is no need to copy pictures to your computer or install specialized software. Uploading pictures from the camera is easy with a computer connected to a network, even when you are away from your regular computing environment.

- This tool supports only computers that run on Windows XP, Windows Vista, and Windows 7.
(To view the manual for LUMIX Image Uploader, use Internet Explorer.)

Getting ready:

- Use [Upload Set] to select the pictures for uploading
- Connect your computer to the Internet
- Create an account for the applicable image-sharing website and prepare your login information

1 Double-click “LUMIXUP.EXE” to start it

- If you have installed “PHOTOfunSTUDIO” from the CD-ROM (supplied), Uploading tool (LUMIX Image Uploader) may start automatically.

2 Select the upload destination

- Do the further steps in accordance with the instructions displayed on the computer screen.

- Because YouTube and Facebook services and specifications are subject to change, operation of online services cannot be guaranteed in the future. Available services and screens are subject to change without notice.
(This service is available as of December 1, 2010)
- Do not upload pictures protected by copyright except when you are the copyright holder or permission has been obtained from the corresponding copyright holder.

Printing

You can connect directly to a PictBridge-compatible printer for printing.

Getting Ready:

- Charge the battery sufficiently. Or, connect the AC adaptor (optional) and DC coupler (optional).
- When printing pictures from the built-in memory, remove any memory cards.
- Adjust the print quality or other settings on your printer, as needed.

Check socket direction and insert straight in. (Damage to socket shape can lead to faulty operation.)

- Do not disconnect the USB connection cable when the cable disconnection icon is displayed (displayed with some printers.).

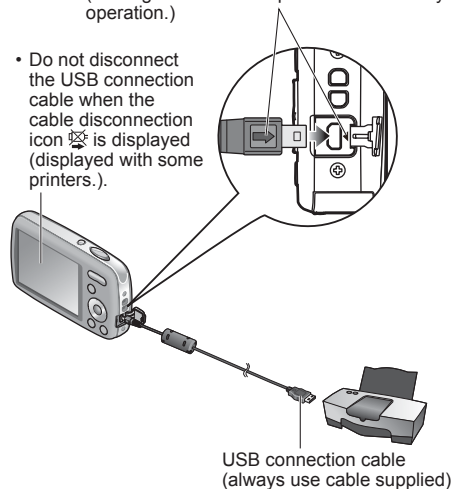

1 Turn on power of camera and printer

2 Connect camera to printer

- Make sure you use the supplied USB connection cable. Use of cables other than the supplied USB connection cable may cause malfunction.

3 Select [PictBridge(PTP)] on the camera



4 Press ◀▶ to select a picture to print, and then press [MENU/SET]

5 Select [Print start]

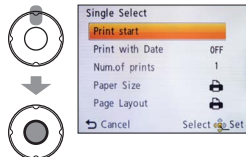

(Print settings (→68))

■ To cancel print

Press [MENU/SET].

- Do not use any other USB connection cables except the one supplied.
- Disconnect USB connection cable after printing.
- Turn off power before inserting or removing memory cards.
- If the battery runs out during communication, a warning beep will sound. Cancel printing and disconnect the USB connection cable. Use a sufficiently charged battery or an AC adaptor (optional) and DC coupler (optional).

Some printers can print directly from the camera's memory card. For details, see the manual for your printer.

Printing multiple pictures

1 Select [Multi Print] in step 4 on the previous page



2 Select item (See below for details)



3 Print (Previous page 5)

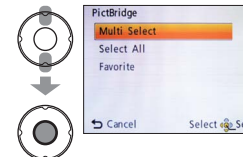

- **[Multi Select]:** ① Scroll between pictures with ▲▼◀▶, select pictures with [MENU/SET] to print. (Press [MENU/SET] again to release selection.)
② Press ◀ to select [OK], and press [MENU/SET].
- **[Select All]:** Print all pictures.
- **[Favorite]:** Print pictures selected as [Favorite].

- Select [Yes] if print confirmation screen is displayed.
- An orange ● displayed during printing indicates an error message.
- Print may be divided into several times if printing a large amount of pictures. (Remaining sheets display may differ from set number.)

Print with date

- **Printing in store:** Only recording date can be printed. Request date printing in store.
 - When printing still pictures of 16:9 Aspect Ratio, check in advance that the store can accept this size.
- **Using computer:** Print settings for recording date and text information can be made using the supplied CD-ROM "PHOTOfunSTUDIO".
- **Using printer:** Recording date can be printed by setting [Print with Date] (→68) to [ON] when connecting to a printer compatible with date printing.

Printing (Continued)

Making print settings on the camera

(Make settings before selecting [Print start])

1 Select item

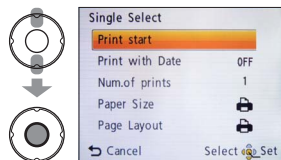

2 Select setting

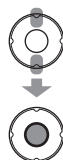

Item	Settings
[Print with Date]	[ON]/[OFF]
[Num. of prints]	Set number of pictures (up to 999 pictures)
[Paper Size]	<div style="display: flex; justify-content: space-between;"> <div style="width: 45%;"> <p> (printer takes priority)</p> <p>[L/3.5"×5"] (89×127 mm)</p> <p>[2L/5"×7"] (127×178 mm)</p> <p>[POSTCARD] (100×148 mm)</p> <p>[16:9] (101.6×180.6 mm)</p> <p>[A4] (210×297 mm)</p> </div> <div style="width: 45%;"> <p>[A3] (297×420 mm)</p> <p>[10×15 cm] (100×150 mm)</p> <p>[4"×6"] (101.6×152.4 mm)</p> <p>[8"×10"] (203.2×254 mm)</p> <p>[LETTER] (216×279.4 mm)</p> <p>[CARD SIZE] (54×85.6 mm)</p> </div> </div>
[Page Layout]	(printer takes priority) / (1 picture, no border) / (1 picture, with border) / (2 pictures) / (4 pictures)

- Items only compatible with the printer may be displayed.
- To arrange "2 pictures" or "4 pictures" in the same still pictures, set the number of prints for the still pictures to 2 or 4.
- To print to paper sizes/layouts not supported by this camera, set to and make settings on the printer. (Consult your printer's operating manual.)
- When setting [Print with Date] to [ON], check the date printing settings on the printer (printer settings may be prioritised).

Viewing on TV screen

You can view still pictures and motion pictures on a TV by connecting the camera to your TV with the AV cable (optional).

- Also consult TV operating manual.

Getting Ready:

- Complete the [TV Aspect] setting.
- Turn off both the camera and television.

Check socket direction and insert straight in. (Damage to socket shape can lead to faulty operation.)

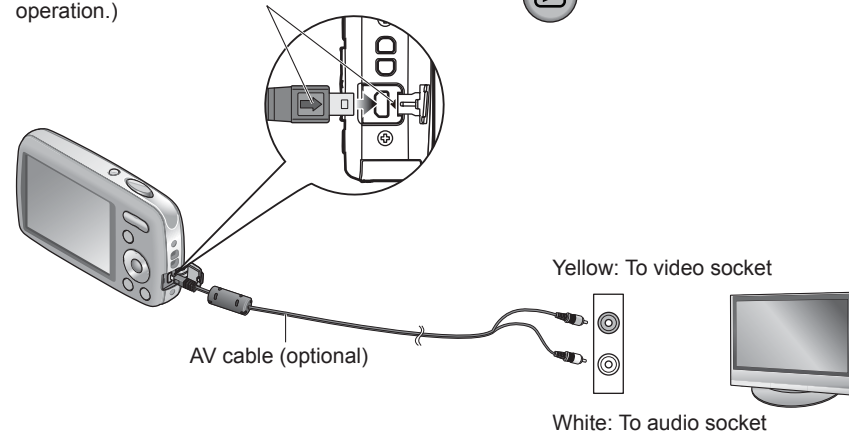

1 Connect camera to TV

2 Turn on TV

- Set to auxiliary input.

3 Turn on camera

4 Press the Playback button



■ When using TVs with an SD card slot

Insert the SD Memory Card into the SD card slot

- Still pictures only can be played back.
- When using SDHC or SDXC Memory Cards, be sure to play each type of card in equipment compatible with the particular format.
- Do not use any other cables except a genuine Panasonic AV cable (optional).
- You can play back pictures on TVs in other countries (regions) which use the NTSC or PAL system when you set [Video Out] in [Setup] menu.
- Some televisions may cut off the edges of pictures, or not display them full screen.
- Pictures rotated to portrait may be blurred slightly.
- If aspect ratios are incorrect or if the top and bottom of the picture are cut off on widescreen or high-definition televisions, change the screen mode settings on the TV side.

List of LCD monitor displays

Press ▼ to change display (→34).

■ In recording

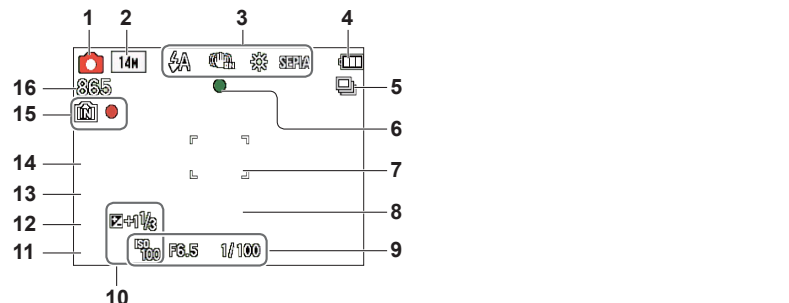

- 1 Recording Mode (→18, 21, 32, 39)
- 2 Picture Size (→46)
Recording quality (→47)
- 3 Flash Mode (→36)
Optical Image Stabilizer (→52)
Jitter alert (→32)
White Balance (→48)
Colour Mode (→51)
- 4 Battery capacity (→15)
- 5 Burst Mode (→50)
- 6 Focus (→18)
- 7 AF area (→33)
- 8 Self-timer Mode (→35)
- 9 ISO Sensitivity (→47)
Aperture value/Shutter speed (→32)
- 10 Exposure Compensation (→38)
AF Assist Lamp (→51)
- 11 Current date/time
- 12 Age in years/months (→43)
- 13 Elapsed recording time (→21)
- 14 Date Stamp (→52)
- 15 Save destination (→14)
Recording state
- 16 Number of recordable pictures (→15)
Remaining recording time (→21)
RXXhXXmXXs*

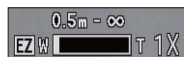

Focus range
Zoom (→20, 50)

■ In playback

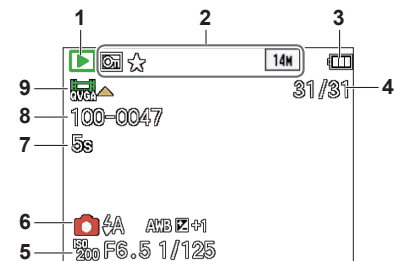

- 1 Playback Mode (→53)
- 2 Protected picture (→61)
Favourites (→60)
Date Stamp (→52)
Colour Mode (→51)
Picture Size (→46)
- 3 Battery capacity (→15)
- 4 Picture number/Total pictures (→22)
Elapsed playback time (→23)
- 5 Recorded date and time
World time setting (→45)
Age in years/months (→43)
Aperture value/Shutter speed (→32)
ISO Sensitivity (→47)
- 6 Recording Mode (→18, 21, 32, 39)
Flash Mode (→36)
White Balance (→48)
Exposure Compensation (→38)
- 7 Motion picture recording time (→23)
XXhXXmXXs*
- 8 Folder/File number (→22, 64)
Save destination (→14)
- 9 Motion pictures (→23)
Cable disconnection warning icon (→66)

* [h], [m] and [s] indicate “hour”, “minute” and “second”.
• Screens shown here are only examples. The actual display may vary.

Message displays

Meanings and required responses to major messages displayed on LCD monitor.

[Some pictures cannot be deleted] [This picture cannot be deleted]

- Non-DCF pictures (→22) cannot be deleted.
→ Save needed data on a computer or other device, and then use [Format] on the camera. (→30)

[No additional selections can be made]

- The number of pictures that can be deleted at once has exceeded.
- More than 999 pictures have been set as [Favorite].
- The number of pictures allowing [Resize] (multiple settings) at once has exceeded.

[Please turn camera off and then on again] [System Error]

- The lens is not working correctly.
→ Turn on power again.
(Consult the dealer or your nearest Service Centre if display still remains)

[Some pictures cannot be copied] [Copy could not be completed]

- Pictures cannot be copied in the following cases:
→ Picture of same name already exists in built-in memory when copying from card.
→ File is not of DCF standard.
→ Picture taken or edited on a different device.

[Not enough space on built-in memory] [Not enough memory on the card]

- There is no space left on the built-in memory or the card. When you copy pictures from the built-in memory to the card (batch copy), the pictures are copied until the capacity of the card becomes full.

[Built-In Memory Error] [Format built-in memory?]

- Displayed when formatting built-in memory via computer, etc.
→ Reformat directly using camera. Data will be deleted.

[Memory card error. This card cannot be used in this camera. Format this card?]

- The card format cannot be used with this camera.
→ Save needed data on a computer or other device, and then use [Format] on the camera. (→30)

[Insert SD card again] [Try another card]

- Access to card has failed.
→ Insert card again.
- Try with a different card.

[Memory Card Error] [Memory card parameter error]

- Card is not of SD standard.
- When cards in capacities of 4 GB or more are used, only SDHC or SDXC Memory Cards are supported.

[Read Error]/[Write Error] [Please check the card]

- Data read has failed.
→ Check whether card has been inserted correctly (→11).
- Data write has failed.
→ Turn off power and remove card, before re-inserting and turning on power again.
- Card may possibly be damaged.
- Try with a different card.

[Motion recording was cancelled due to the limitation of the writing speed of the card]

- When recording motion picture, use a card rated with an SD speed class* of "Class 6" or higher.
* SD speed class refers to a specification for sustained write speeds.
- If recording stops even when using a card with speed of "Class 6" or faster, the data writing speed is low. We recommend backing up the data on the memory card and reformatting it. (→30)
- Motion picture recording may be automatically terminated with certain cards.

[A folder cannot be created]

- Folder numbers in use have reached 999.
→ Save needed data on a computer or other device, and then use [Format] on the camera. (→30)

[Picture is displayed for 16:9 TV] [Picture is displayed for 4:3 TV]

- AV cable is connected to camera.
→ To remove message immediately → Press [MENU/SET].
→ To change aspect ratio → Change [TV Aspect] (→29).
- USB connection cable is only connected to camera.
→ Message disappears when cable is also connected to another device.

Try checking these items (→74 - 79) first.

If the problem persists, performing [Reset] in the [Setup] menu may resolve the issue. (Note that except for some items such as [Clock Set], all settings are returned to their values from the time of purchase.)

Battery, power

Camera does not work even if power is turned on.

- Battery is not inserted correctly (→11), or needs recharging.

The power cuts off during use.

- Battery needs recharging.
- Camera is set to [Auto Power Off]. (→28)
→ Turn on the power again.

Recording

Cannot record pictures.

- The camera is in Playback Mode.
→ Press the Playback button to switch to Recording Mode.
- Built-in memory/card is full. → Free space by deleting unwanted pictures (→25).

Recorded pictures look white.

- Lens is dirty (fingerprints, etc.).
→ Clean lens surface with a soft, dry cloth.
- Lens is foggy (→4).

Recorded pictures are too bright/too dark.

- Adjust the exposure (→38).

2-3 pictures are taken when I press the shutter button just once.

- Camera is set to use [Burst] (→50).

Focus not aligned correctly.

- Not set to mode appropriate for distance to subject. (Focus range varies according to Recording Mode.)
- Subject outside of focus range.
- Caused by jitter or subject movement (→52).

Recorded pictures are blurred. Optical Image Stabilizer ineffective.

- Shutter speed is slower in dark locations and Optical Image Stabilizer is less effective.
→ Hold camera firmly with both hands, keeping arms close to body.
- Set [Digital Zoom] to [OFF] and [Sensitivity] to [ISO]. (→47, 50)

Recording (Continued)

Recorded pictures appear coarse, or there is interference.

- ISO Sensitivity is high, or shutter speed is low.
(Default [Sensitivity] setting is [ISO] – interference may appear with indoor pictures.)
→ Lower [Sensitivity] (→47).
→ Set [Color Mode] to [NATURAL] (→51).
→ Take pictures in brighter locations.
- Camera is set to [High Sens.].
(Picture becomes slightly coarser in response to high sensitivity.)

Brightness or colouring of recorded picture different from real life.

- Taking pictures under fluorescent lighting may require a faster shutter speed and result in slightly changed brightness or colouring, but this is not a fault.

Red banding may appear on the LCD monitor or part or the entire screen may have a reddish tint, when recording or pressing the shutter button halfway.

- This is a characteristic of CCD and may appear if subject contains brighter areas. Some blurring may occur around these areas, but this is not a fault. This will be recorded in motion pictures, but not in still pictures.
- We recommend keeping the screen away from strong light sources such as sunlight when taking pictures.



Motion picture recording stops midway.

- With some cards, access display may appear briefly after recording, and recording may end midway.
- When recording motion picture, use a card rated with an SD speed class* of "Class 6" or higher.
* SD speed class refers to a specification for sustained write speeds.
- If recording stops even when using a card with speed of "Class 6" or faster, the data writing speed is low. We recommend backing up the data on the memory card and reformatting it. (→30)

The beep volume is low.

- The speaker is blocked.

LCD monitor

Monitor sometimes shuts off even though power is on.

- After recording, monitor shuts off until next picture can be recorded. (Approx. 6 seconds (max.) when recording to the built-in memory)

Brightness is unstable.

- Aperture value is set while shutter button is pressed halfway.
(Does not affect recorded picture.)

LCD monitor (Continued)

Monitor flickers indoors.

- Monitor may flicker after turning on (prevents influence from fluorescent lighting).

Black/blue/red/green dots or interference appears. Monitor looks distorted when touched.

- This is not a fault, and will not be recorded on the actual pictures, so there is no need to worry.

Date/age is not displayed.

- The current date and [Age] are displayed for about 5 seconds in instances such as when the camera is turned on, when you switch from Playback Mode to Recording Mode, when you switch to [Baby] Scene Mode.

Flash

No flash emitted.

- Flash set to [Forced Flash Off]  (→36).
- Flash is disabled when using [Burst] or when using the following Scene Modes. [Scenery], [Panorama Assist], [Night Scenery], [Sunset], [Fireworks]

Multiple flashes are emitted.

- Red-Eye Reduction is active (→36). (Flashes twice to prevent eyes from appearing red.)

Playback

Pictures have been rotated.

- [Rotate Disp.] is set to .
- For full-screen display without picture rotation, set [OFF].

Cannot view pictures.

- Press the Playback button.
- No pictures in built-in memory or card (pictures are played from card if inserted, from built-in memory if card is not inserted).
- Camera set to [Filtering Play].
→ Set Playback Mode to [Normal Play] (→53).

Folder/file number displayed as [-]. Picture is black.

- Picture edited on computer or taken with a different device.
- Battery removed immediately after picture taken, or picture taken with low battery.
→ Use [Format] to delete (→30).

The playback volume and beep volume are low.

- The speaker is blocked.

Playback (Continued)

Incorrect date displayed in Calendar Playback.

- Picture edited on computer or taken with a different device.
- [Clock Set] is incorrect (→16).
- (Incorrect date may be displayed in Calendar Playback on pictures copied to computer and then back to camera, if computer and camera dates differ.)

White round spots like soap bubbles appear on the recorded picture.







- If you take a picture with the flash in a dark place or indoors, white round spots may appear on the picture caused by the flash reflecting particles of dust in the air. This is not a fault. A characteristic of this is that the number of round spots and their position differ in every picture.



[Thumbnail is displayed] is shown on the screen.

- The still pictures may have been recorded with another device. If so, they may be displayed with poor picture quality.

Blackened red areas in recorded pictures. (DMC-S3 only)

- When digital red-eye correction (, , ) is operating, if a subject is recorded that has skin-coloured areas with red areas inside, the digital red-eye correction function may blacken the red areas.
→ We recommend setting the Flash Mode to ,  or , or [Red-Eye Removal] to [OFF] before recording.

The sound of the recorded motion pictures sometimes breaks up.

- This unit automatically adjusts the aperture during motion picture recording. At such times, the sound may break up. This is not a malfunction.

Motion pictures recorded on this camera cannot be played on other devices.

- Motion pictures (Motion JPEG) recorded with this camera may not be played on digital cameras of other manufacturers. Additionally, motion pictures recorded with this camera cannot be played on Panasonic LUMIX digital cameras sold before July 2008. (However, motion pictures recorded with LUMIX digital cameras sold before this date can be played on this camera.)

TV, computer, printer

No image appear on TV. Image blurred or not coloured.

- Not connected correctly. (→69)
- The television has not been switched to auxiliary input.
- Check the [Video Out] setting (NTSC/PAL) on the camera. (→29)

TV screen display different to LCD monitor.

- Aspect ratio may be incorrect or edges may be cut off with certain televisions.

Cannot play motion pictures on TV.

- Card is inserted into TV.
→ Connect the camera to the TV with the AV cable (optional), and then access Playback Mode on the camera. (→69)

TV, computer, printer (Continued)

Picture is not displayed on full TV screen.

- Check [TV Aspect] settings (→29).

Cannot send pictures to computer.

- Not connected correctly (→63).
- Check whether computer has recognised camera.
- Select [PC] when connecting the camera to your computer. (→63)

Computer does not recognise card (only reads built-in memory).

- Disconnect USB connection cable and reconnect with card in place.

The card is not recognised by the computer.

(You are using an SDXC Memory Card.)

- Make sure your computer supports SDXC memory cards.
<http://panasonic.net/avc/sdcard/information/SDXC.html>
- When you insert a card, a message will be displayed requesting you to format the card, but do not format it.
- If [Access] remains displayed on the LCD monitor, turn off the camera and then disconnect the USB cable.

Uploading to YouTube or Facebook cannot be performed properly.

- Confirm that the login information (login ID, user name, e-mail address and password) is correct.
- Confirm that the PC is connected to the Internet.
- Confirm that the resident software (such as anti-virus software and the firewall, etc.) is not blocking access to YouTube or Facebook.
- Check the YouTube or Facebook site.

Cannot print when connecting to printer.

- Printer is not compatible with PictBridge.
- Select [PictBridge(PTP)] when connecting the camera to your computer. (→66)

Cannot print the date.

- Make date printing settings before printing.
→ With supplied software: Select “with dates” within print settings.
- Use [Date Stamp] function when taking a picture. (→52)

Edges cut off pictures when printing.

- Release any trimming or edgeless printing settings on printer before printing.
(Consult printer operating manual.)
- The pictures were recorded in **16:9** aspect ratio.
→ If printing in shop, check if 16:9 sizes can be printed.

Others

Menu not displayed in desired language.

- Change [Language] setting (→31).

Camera rattles if shaken.

- This sound is made by the lens movement and is not a fault.

Red lamp illuminated when pressing shutter button halfway in dark locations.

- [AF Assist Lamp] is set to [ON] (→51).

AF Assist Lamp is not illuminated.

- [AF Assist Lamp] is set to [OFF].
- Not illuminated in bright locations or when using [Scenery], [Night Scenery], [Self Portrait], [Fireworks], or [Sunset] Scene Modes.

Camera is hot.

- Camera may become a little warm during use, but this does not affect performance or quality.

Lens makes a clicking noise.

- When brightness changes, the lens may make a clicking noise and the monitor brightness may also change, but this is due to aperture settings being made.
(Does not affect recording.)

Clock is incorrect.

- Camera has been left for a long period.
→ Reset the clock (→16).
- It takes too long to set (clock will be behind by the same lapse of time).

When using zoom, picture becomes slightly warped and the edges of the subject become coloured.

- Pictures may be slightly warped or coloured around the edges, depending on the zoom ratio, but this is not a fault.



File numbers are not recorded in sequence.

- File numbers are reset when new folders are created (→64).

File numbers have jumped backwards.

- Battery was removed/inserted with power on.
(Numbers may jump backwards if folder/file numbers are not correctly recorded.)

When the camera is left alone, the slide show is suddenly displayed.

- This is the [Auto Demo] to introduce the features of the camera. Press  /  to return to the menu screen.

Usage cautions and notes

When in use

- Camera may become warm if used for long periods of time, but this is not a fault.
- **Keep the camera as far away as possible from electromagnetic equipment (such as microwave ovens, TVs, video games etc.).**
 - If you use the camera on top of or near a TV, the pictures and sound on the camera may be disrupted by electromagnetic wave radiation.
 - Do not use the camera near cell phones because doing so may result in noise adversely affecting the pictures and sound.
 - Recorded data may be damaged, or pictures may be distorted, by strong magnetic fields created by speakers or large motors.
 - Electromagnetic wave radiation generated by microprocessors may adversely affect the camera, disturbing the pictures and sound.
 - If the camera is adversely affected by electromagnetic equipment and stops functioning properly, turn the camera off and remove the battery or disconnect the AC adaptor (optional). Then reinsert the battery or reconnect the AC adaptor and turn the camera on.
- **Do not use the camera near radio transmitters or high-voltage lines.**
 - If you record near radio transmitters or high-voltage lines, the recorded pictures and sound may be adversely affected.
- Do not keep objects that may be influenced magnetically close to the speaker.
 - Magnetized objects such as bank cards, commuter passes, watches, may be adversely affected by the magnetic influence of the speaker.
- Do not extend the supplied cord or cable.
- Do not allow camera to come into contact with pesticides or volatile substances (can cause surface damage or coating to peel).
- Never leave the camera and the battery in a car or on a car hood in the summer. It may cause leakage of the battery electrolyte, generation of heat, and may cause a fire and the battery to burst due to the high temperature.

Caring for your camera

To clean your camera, remove the battery or disconnect the power plug from the outlet, and wipe with a soft, dry cloth.

- Use a damp cloth to remove stubborn stains, before wiping again with a dry cloth.
- Do not use benzene, thinners, alcohol, or kitchen detergent, as these may damage the outer casing and finish of the camera.
- If using a chemically-treated cloth, read the supplied instructions carefully.

When not using for a while

- Turn off camera power before removing battery and card (ensure that battery is removed to prevent damage through over-discharge).
- Do not leave in contact with rubber or plastic bags.
- Store together with a drying agent (silica gel) if leaving in a drawer, etc. Store batteries in cool (15 °C - 25 °C) places with low humidity (40 %RH - 60 %RH) and no major temperature changes.
- Charge battery once per year and use completely before storing again.

Memory cards

- To prevent damage to cards and data
 - Avoid high temperatures, direct sunlight, electromagnetic waves, and static electricity.
 - Do not bend, drop, or expose to strong impacts.
 - Do not touch connectors on reverse of card or allow them to become dirty or wet.
- When disposing of/transferring memory cards
 - If using the "format" or "delete" functions on your camera or computer, this only changes the file management information, and does not completely delete the data from within the memory card. When disposing of or transferring your memory cards, we recommend physically destroying the memory card itself, or using commercially available computer data erasing software to completely delete the data from the card. Data within memory cards should be managed responsibly.

LCD Monitor

- Do not press hard on the LCD monitor. This may cause uneven display and damage the monitor.
- Do not press on the monitor with sharp, hard instruments such as ballpoint pens.
- Do not rub the LCD monitor forcefully or push on it.
- In cold climates or other situations when the camera becomes cold, the LCD monitor may be slightly less responsive than normal immediately after startup. Normal brightness will return once the internal components have warmed up.

Personal Information

If you set [Age] in [Baby] Mode, keep in mind that the camera and recorded pictures will contain personal information.

- Disclaimer
 - Data containing personal information can be altered or lost due to malfunction, static electricity, accidents, breakdowns, repairs, or other operations. Panasonic will not be liable for any damage that occurs, direct or indirect, as a result of the alteration or loss of data containing personal information.
- When ordering repairs or transferring/disposing of the camera
 - To protect your personal information, please reset the settings. (→29)
 - If any pictures are contained in the built-in memory, copy (→62) them to a memory card if necessary, and then format (→30) the built-in memory.
 - Remove the memory card from the camera.
 - When ordering repairs, the built-in memory and other settings may be returned to the initial purchase state.
 - If the above operations cannot be performed because of a camera malfunction, consult with the dealer or nearest Service Centre.

When transferring or disposing of your memory card, see "When disposing of/transferring memory cards" in the previous section.



- SDXC Logo is a trademark of SD-3C, LLC.
- QuickTime and the QuickTime logo are trademarks or registered trademarks of Apple Inc., used under license therefrom.
- YouTube is a trademark of Google Inc.
- This product uses "DynaFont" from DynaComware Corporation. DynaFont is a registered trademark of DynaComware Taiwan Inc.
- Other names, company names, and product names printed in these instructions are trademarks or registered trademarks of the companies concerned.