

# Panasonic®

## Owner's Manual <Full version> Network Audio Connector Model No. SH-ALL1C

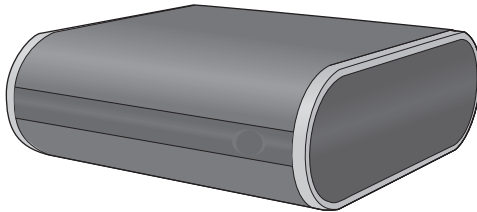

Thank you for purchasing this product.  
Please read these instructions carefully before using this product,  
and save this manual for future use.

Register online at [www.panasonic.com/register](http://www.panasonic.com/register) (U.S. customers only)

SQT0184



# Table of contents

Accessories .....	3
Unit care .....	4
Control reference guide.....	5
Indicator illumination .....	6
Connections .....	8
Network settings.....	12
Enjoying music.....	19
Firmware updates .....	23
Others .....	24
Troubleshooting.....	27
Specifications .....	30

## How to use this manual



Click/Tap this icon to jump to “Table of contents”.

- Pages to be referred to are indicated as “→ ○○”. You can jump to the corresponding page by clicking/tapping this.



# Accessories

## 1 AC power supply cord (AC mains lead)

---

**For the U.S.A. and Canada**  
(K2CB2CB00022)

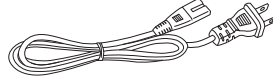

**For the United Kingdom and Ireland**  
(K2CT2YY00097)

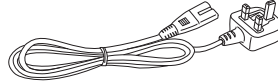

**For Continental Europe**  
(K2CQ2YY00119)

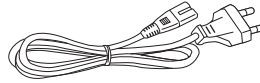

**For Australia and New Zealand**  
(K2CJ2YY00101)

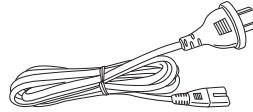

**1 Audio cable**  
(K2KYYYY00242)



**2 Stands**  
(RYQ1443-K1)

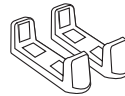

- Do not use AC power supply cord (AC mains lead) with other equipment.
- Product numbers provided in this owner's manual are correct as of May 2014. These may be subject to change.



## Unit care

Clean this unit with a soft, dry cloth.

- Never use alcohol, paint thinner or benzine to clean this unit.
- Before using chemically treated cloth, carefully read the cloth's instructions.

### ■ To dispose or transfer this unit

The unit may keep the user settings information in the unit. If you discard this unit either by disposal or transfer, then follow the procedure to return all the settings to the factory defaults to delete the user settings.

(→ 27, “To return all settings to the factory defaults”)

- The operation history may be recorded in the memory of this unit.

#### **Disposal of Old Equipment Only for European Union and countries with recycling systems**



This symbol on the products, packaging, and/or accompanying documents means that used electrical and electronic products must not be mixed with general household waste.

For proper treatment, recovery and recycling of old products, please take them to applicable collection points in accordance with your national legislation.

By disposing of them correctly, you will help to save valuable resources and prevent any potential negative effects on human health and the environment.

For more information about collection and recycling, please contact your local municipality.

Penalties may be applicable for incorrect disposal of this waste, in accordance with national legislation.



# Control reference guide

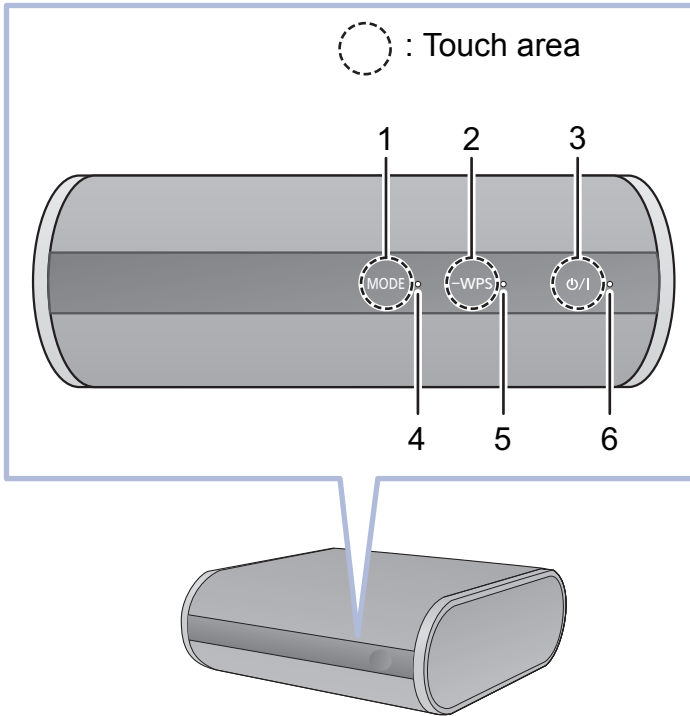



- 1 Mode switch [MODE]  
Set the downsampling setting (→ 24)/  
Turn the beep sound on/off (→ 25)
- 2 WPS pairing switch [-WPS]  
Enter WPS pairing mode (→ 16) / firmware update mode (→ 23)
- 3 Standby/on switch [⏻/⏻]  
Touch to switch the unit from on to standby mode or vice versa. In standby mode, the unit is still consuming a small amount of power.
- 4 Mode indicator (amber)
- 5 Network indicator (blue/red)
- 6 Operation indicator (amber)





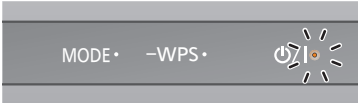
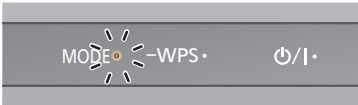

# Indicator illumination

The indicator patterns illustrated below are displayed during normal operational conditions.

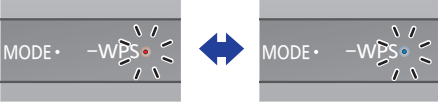
Indicator	Description
<p><b>Operation indicator (amber)</b></p> 	<p><b>Blinks once</b></p> <ul style="list-style-type: none"><li>• The unit detects the switch touched.</li></ul> <p><b>Blinks twice</b></p> <ul style="list-style-type: none"><li>• The unit detects a valid operation performed by touching and holding the switch.</li></ul>
<p><b>Mode indicator (amber)</b></p> 	<p><b>Blinks once</b></p> <ul style="list-style-type: none"><li>• The following setting is turned on.<ul style="list-style-type: none"><li>“Downsampling” (→ 24)</li><li>“Operation sound setting” (→ 25)</li></ul></li><li>– When the setting is turned off, it blinks twice.</li></ul> <p><b>Blinks</b></p> <ul style="list-style-type: none"><li>• The unit is in process of turning to standby mode.<ul style="list-style-type: none"><li>– Do not disconnect the AC power supply cord (AC mains lead). Doing so may cause malfunction or damage.</li></ul></li></ul> <hr/> <p></p> <ul style="list-style-type: none"><li>• The mode indicator also blinks when the volume is changed on the app. (→ 19)</li></ul>

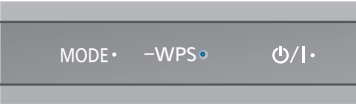

Indicator	Description
<p><b>Network indicator (blue/red)</b></p> 	<p><b>Blinks alternately</b></p> <ul style="list-style-type: none"><li>• The unit is carrying out an internal process.<ul style="list-style-type: none"><li>– Wait for maximum of approximately 60 seconds before the blinking stops.</li><li>– Do not disconnect the AC power supply cord (AC mains lead). Doing so may cause malfunction or damage.</li></ul></li></ul>
<p><b>Network indicator (blue)</b></p> 	<p><b>Blinks slowly</b></p> <ul style="list-style-type: none"><li>• The unit is ready for network setup. (→ 12)</li></ul> <p><b>Blinks</b></p> <ul style="list-style-type: none"><li>• The unit is waiting for the WPS connection. (→ 16)</li></ul> <p><b>Blinks fast</b></p> <ul style="list-style-type: none"><li>• The unit is waiting for the WPS PIN code connection. (→ 16)</li></ul>
<p><b>Network indicator (blue)</b></p> 	<p><b>Lights up</b></p> <ul style="list-style-type: none"><li>• The unit is connected to the network.</li></ul>
<p><b>Network indicator (red)</b></p> 	<p><b>Blinks</b></p> <ul style="list-style-type: none"><li>• The unit is connecting to the network.<ul style="list-style-type: none"><li>– When the network connection cannot be established, the blinking keeps going. Check the network connection. (→ 12)</li></ul></li></ul>



# Connections

You can enjoy music from a device on the network by using this unit. At first, you must connect an audio system, amplifier or receiver, etc. to this unit.

Ex. Connecting to an audio system

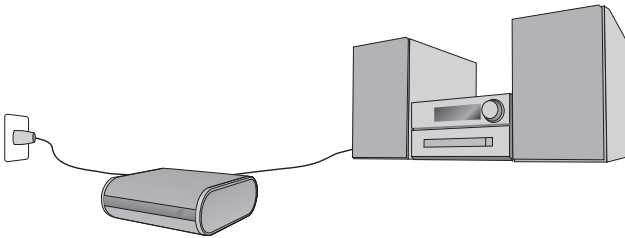

## STEP1: Installation

This unit can be installed either vertically or horizontally.

### ■ Horizontal

Install the unit with the rubber feet side down as shown below.

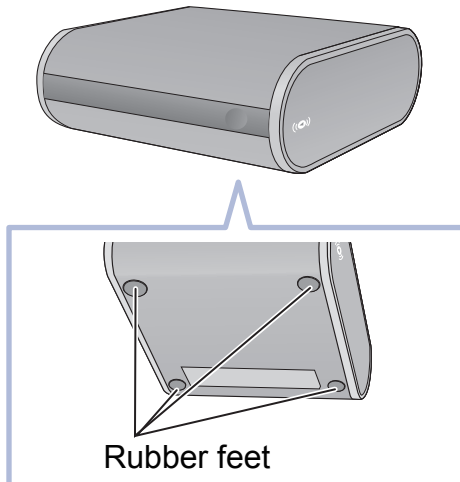





## ■ Vertical

Place the stands and fit the unit into them.

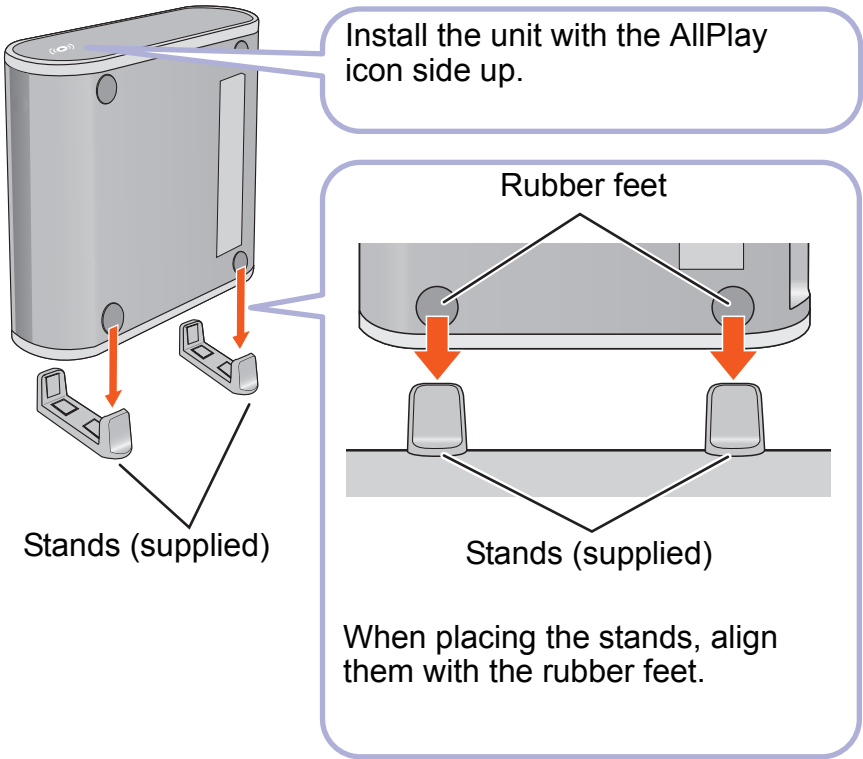



## STEP2: Connecting to an audio system, etc.

Connect an audio system, amplifier or receiver, etc. to this unit using an audio cable (supplied) or an optical cable (not supplied).

### ■ Using an audio cable (supplied)

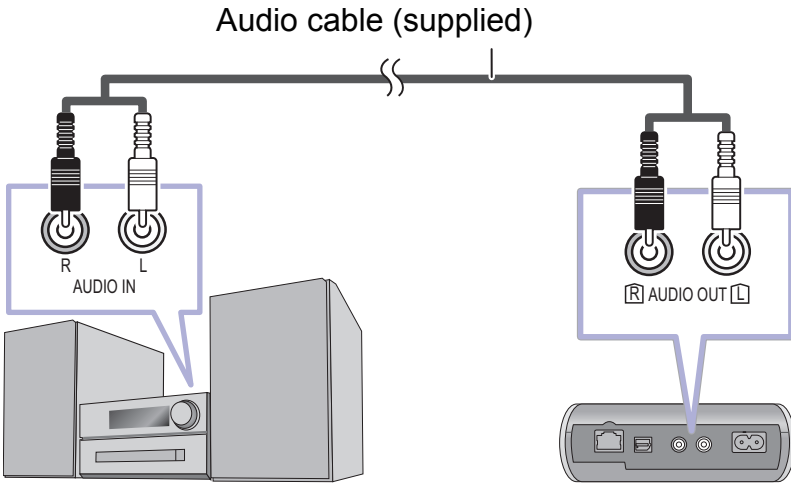

### ■ Using an optical cable (not supplied)

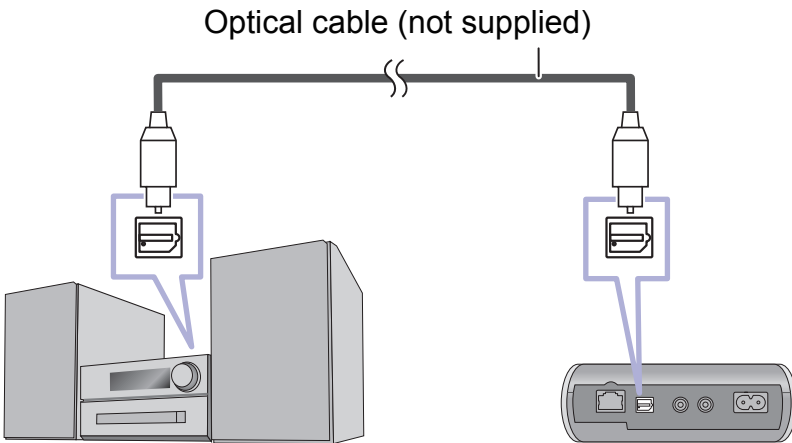

- For details, refer to the operating instructions of the connected device.



## STEP3: Connecting to an AC outlet

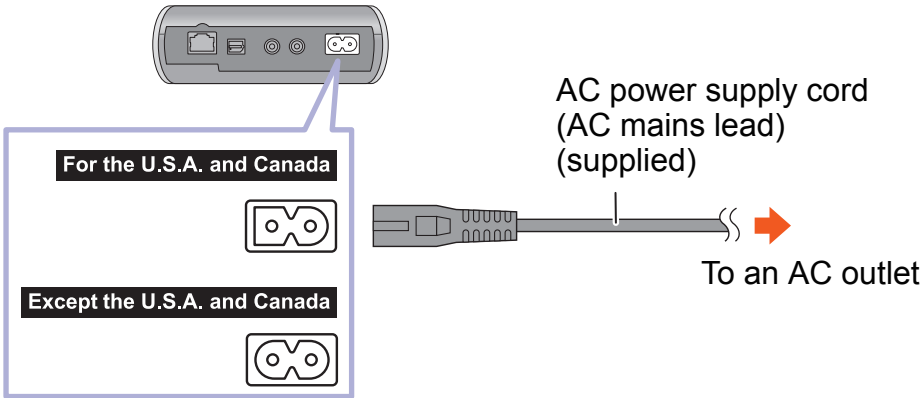

- It takes some time until the unit connects to a network and becomes ready for use after it is connected to an AC outlet and turned on.  
Once connected to a network, the unit can be used at all times unless the AC outlet is turned off.  
We recommend connecting the unit to an AC outlet that is always live.
- Since the network function of the unit remains active even in standby mode, the unit consumes approximately 2.5 W of power in standby mode.
- For the purpose of power conservation, the unit can be disconnected if you will not be using it for extended period of time.
- Do not disconnect the AC power supply cord (AC mains lead) when the unit is on. Doing so may cause malfunction or damage.



# Network settings

You can stream music from a device on the network by using the Qualcomm® AllPlay™ smart media platform or DLNA feature. To use these features, this unit must join the same network as the device.

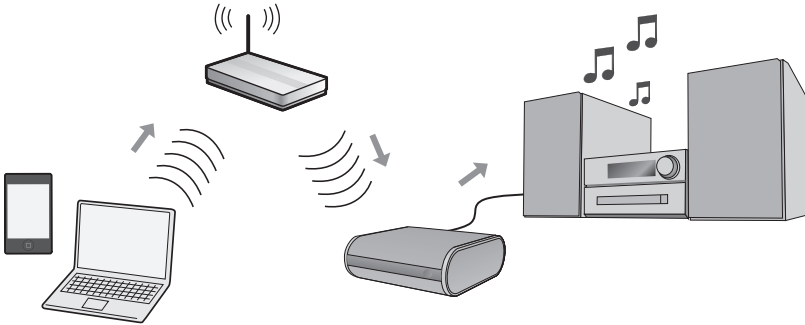

**Choose a network setting method from the following.**

## “Using an Internet browser” (→ 13)

- You can access this unit’s network settings from the Internet browser on your smartphone or PC, etc.

## “Using WPS (Wi-Fi Protected Setup™)” (→ 16)

- If your wireless router supports WPS, you can set up a connection by either pressing the WPS button, or entering the WPS PIN code.

## “Using a LAN cable” (→ 17)

- You can make a stable connection to the network with a LAN cable.



- The setting will be canceled after the set time limit. In that case, try the setting again.
- To cancel this setting in the middle, touch [⏻/I] to turn off the unit.



## Using an Internet browser

- The following steps are based on a smartphone.
- Do not connect a LAN cable. Doing so will disable the Wi-Fi® function.

### 1 Turn this unit on.

### 2 Go to Wi-Fi® settings on the device.

- Proceed to the next step after the network indicator changes from blinking in blue and red to blinking in blue.
  - The blinking in blue starts after maximum of approximately 60 seconds. If the blinking in blue does not start, restore the factory defaults. (→ 27)
- Make sure that DHCP is enabled for the network settings on the device.



### 3 Select “AllPlay XXXXXX\_AJ” to connect to this unit.

- “X” stands for a digit that is unique to each set.





#### 4 Start the Internet browser on the device to display the settings page.

- **iOS** : The settings page will be automatically displayed.
- **Except iOS** : Once you open the Internet browser, the settings page will be displayed
  - If the settings page is not displayed, type “http://172.19.42.1/” into the URL address field.

#### 5 Type a device name and then select “Next”.

- The device name will be displayed as this unit’s name on the network.
- The guaranteed limit is 32 characters.
- The device name is set when “Next” is selected.
- You can also change the device name after the network connection is set up. (→ 18)

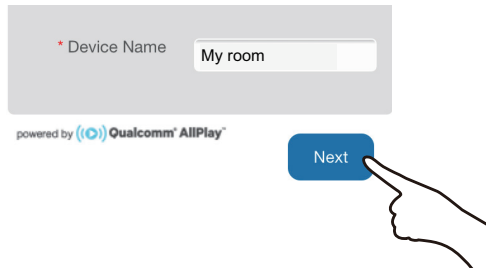



## 6 Select your network name (SSID) and type the password.

- Check the wireless router for the network name (SSID) and the password.
- A list of network names (SSIDs) will be appeared when you select the “Network Name” box.
- To show the characters typed in the “Password” box, select “Show Password”.
- If your network requires specific settings, select “DHCP” to disable DHCP.
  - You can use specific IP address, subnet mask, default gateway, primary DNS, etc.

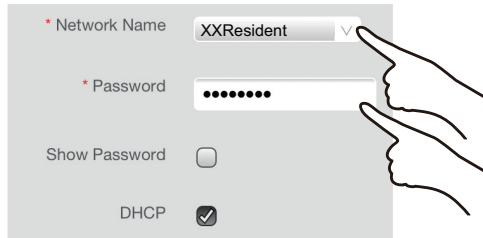

## 7 Select “Connect” to apply the settings.

- When the connection is established, the network indicator (blue) lights up.
- Depending on the device, the connection complete screen may not be displayed.

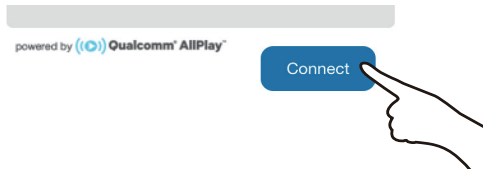

If the network indicator does not light up, check the network name (SSID) and the password, and then try the setting again.

## 8 Make sure the device is connected to your network.



- Enable Java and cookies in your browser settings.



## Using WPS (Wi-Fi Protected Setup™)

- Do not connect a LAN cable. Doing so will disable the Wi-Fi function.

e.g.,

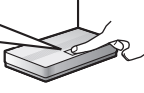

A compatible wireless router may have the WPS identifier mark.

### 1 Turn this unit on.

- Proceed to the next step after the network indicator changes from blinking in blue and red to blinking in blue.
  - The blinking in blue starts after maximum of approximately 60 seconds. If the blinking in blue does not start, restore the factory defaults. (→ 27)

### 2 Touch and hold [-WPS] on the unit.

- The network indicator (blue) blinks faster.

### 3 Press the WPS button on the wireless router.

- When the connection is established, the network indicator (blue) lights up.

## ■ Using the WPS PIN code

### After step 2

#### 1 Touch and hold [-WPS] again.

- The network indicator (blue) blinks even faster.

#### 2 Enter the PIN code “64428147” into the wireless router.

- When the connection is established, the network indicator (blue) lights up.



- When canceling the setting in the middle by touching [⏻/|], the unit takes a while to turn off.
  - The mode indicator (amber) blinks until the unit is turned off.
- Once the unit enters WPS PIN code mode, you cannot set up using the WPS button. To use the WPS button, turn off and then on the unit, and redo the network settings.
- For details, refer to the operating instructions of the wireless router.





## Using a LAN cable

- 1 Disconnect the AC power supply cord (AC mains lead).
- 2 Connect this unit to a broadband router, etc. using a LAN cable.  
e.g.,

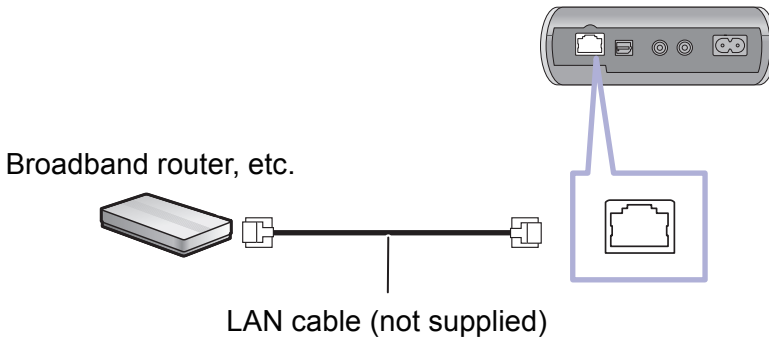

- 3 Connect the AC power supply cord (AC mains lead) to this unit, and turn the unit on.

- When the connection is established, the network indicator (blue) lights up.



- Use category 5 or above straight LAN cables (STP) when connecting to peripheral devices.
- The LAN cable must be connected or disconnected while the AC power supply cord (AC mains lead) is disconnected.
- Inserting any cable other than a LAN cable in the LAN port can damage the unit.
- If the LAN cable is disconnected, the network-related settings (→ 18) will be initialized. In that case, make the settings again.
- When a LAN cable is connected, the Wi-Fi function will be disabled.
  - Power consumption will be reduced when the unit is turned on or is in standby mode.



## To make network-related settings

You can change this unit's name on the network, and use specific IP address, subnet mask, default gateway, primary DNS, etc.

### Preparation

- Complete the network settings.

**1 Check this unit's IP address (→ 26), and note it down.**

**2 Connect your device to the same network as this unit.**

**3 Start an Internet browser on your device and then type this unit's IP address into the address field to display the settings page.**

- It may take a few minutes until the settings page is displayed depending on the environment. In that case, reload the browser.
- If the unit is connected with Wi-Fi, only a device name can be changed. Close the settings page after changing the device name.
  - To change the device name, select “Change”, and type a new device name, and then select “Apply”.

**4 Type a device name and then select “Next”.**

- Refer to the step 5 of “Using an Internet browser” (→ 14) for details on a device name.

**5 Select and input the details.**

- If your network requires specific settings, select “DHCP” to disable DHCP.
  - You can use specific IP address, subnet mask, default gateway, primary DNS, etc.

**6 Select “Connect” to apply the settings.**

- When the connection is established, the network indicator (blue) lights up.



# Enjoying music

You can enjoy music on your home network and online music services.

## Home network

To stream music from the device on the network to this unit as AllPlay/DLNA speakers, you need to download the app “Panasonic Music Streaming” (free of charge), etc.

- **iOS** : App Store
- **Android** : Google Play™



### Preparation

- Connect the following devices to the same network as this unit.
  - Device with “Panasonic Music Streaming”, etc. installed
  - Device containing music

The following steps are based on “Panasonic Music Streaming”.

### 1 Turn this unit on.

- The network indicator (blue) lights up.
  - If the network indicator is blinking in blue and red, wait until the blinking stops.

### 2 Start the app “Panasonic Music Streaming”.

### 3 Select a music source.

- To add music source, select “+” and then select the device containing music.
  - The added music source is numbered in order from 1.

### 4 Select a song to playback.

- To stop the playback, select stop or pause.





**5 iOS** : From “

e.g.,



**Android** : From “Select Speaker”, select this unit as the output speakers.

- If you have multiple AllPlay speakers, you can enjoy synchronized sound from them. Select “

- This unit will turn on automatically from standby mode when you select the unit as the output speakers.
  - In these cases, the beginning part of the music may not be played back.
  - Depending on the app, the conditions for activating this function may differ.
  - The unit may not turn on even when selected as the output speakers. In that case, start playback.
- This unit will be displayed as “Panasonic ALL1C” if the device name is not set.
  - DLNA speakers (www.panasonic.com/global/consumer/homeav/allseries/service
  - For details on the app “Panasonic Music Streaming”, visit <http://panasonic.jp/support/global/cs/>

(These sites are in English only.)



## Online music services

This unit is compatible with several music services.

Visit the following website for the compatibility information.

[www.panasonic.com/global/consumer/homeav/allseries/service](http://www.panasonic.com/global/consumer/homeav/allseries/service)

### Preparation

- Make sure that the network is connected to the Internet.
- Connect a device with a compatible app installed to the same network as this unit.

### 1 Turn this unit on.

- The network indicator (blue) lights up.
  - If the network indicator is blinking in blue and red, wait until the blinking stops.

### 2 Start the app, and select a song to playback.

### ■ Using Spotify

- **For Canada** Spotify is not available.
- You will need Spotify Premium. For details, visit the following website.  
[www.spotify.com/connect/](http://www.spotify.com/connect/)

### After step 2

### 3 Select the square image of the song's cover art in the bottom left of the playback screen.

### 4 From “”, select this unit as the output speakers.

- To enjoy synchronized sound from the multiple AllPlay speakers, you need to group the speakers using the app “Panasonic Music Streaming”. (→ 19)



## ■ Using online music services other than Spotify

### After step 2

#### 3 From “((O))”, select this unit as the output speakers.

- Depending on the service, you might need to open full screen player to display “((O))”.
- If you have multiple AllPlay speakers, you can enjoy synchronized sound from them. Select “Group” and then select the speakers to group.



- This unit will turn on automatically from standby mode when you select the unit as the output speakers.
  - In these cases, the beginning part of the music may not be played back.
  - Depending on the app, the conditions for activating this function may differ.
  - The unit may not turn on even when selected as the output speakers. In that case, start playback.
- This unit will be displayed as “Panasonic ALL1C” if the device name is not set.
- Registration/subscription is required.
- Fees may apply.
- Services, icons, and specifications subject to change.
- For details, visit the individual music service’s website.



# Firmware updates

Occasionally, Panasonic may release updated firmware for this unit that may add or improve the way a feature operates. These updates are available free of charge.

## Preparation

- Connect this unit to the network. (→ 12)
  - Make sure that the network is connected to the Internet.

## 1 Touch and hold [-WPS]. When the operation indicator (amber) starts blinking and while you are still touching and holding [-WPS], touch [MODE].

- The mode indicator (amber) starts blinking.
  - Release your fingers from the switches after the blinking starts.
  - If the mode indicator goes off after approximately 1 minute, the latest firmware is already installed. The firmware update will be canceled.
  - No other operations can be performed.
- The update will require approximately 4 minutes.
  - Do not disconnect the AC power supply cord (AC mains lead). Doing so may cause malfunction or damage.

## 2 After the mode indicator (amber) stops blinking and lights up, disconnect the AC power supply cord (AC mains lead).

## 3 After 3 minutes, reconnect the AC power supply cord (AC mains lead), and turn the unit on.

- The network indicator will blink in blue and red alternately for up to a minute. The update is complete when it stops blinking.



- If the mode indicator (amber) keeps blinking for more than 5 minutes, an error may have occurred. Refer to firmware update troubleshooting. (→ 28)



# Others

## Downsampling

Set whether the high quality audio output from the optical terminal will be output as is (“off”) or not (“on”).

- **When this unit is connected to a device that does not support a sampling frequency of 88.2 kHz or higher, change the setting to “on”.**

**This unit will downsample the frequency as follows before outputting audio.**

(Audio will not be heard when “off” (default) is set.)

- 88.2 kHz / 176.4 kHz → 44.1 kHz
- 96 kHz / 192 kHz → 48 kHz

### **Touch and hold [MODE].**

- The mode indicator (amber) blinks.
  - Blinks once: on
  - Blinks twice: off (default)

And then, the network indicator is blinking in blue and red while the setting is being changed.

Operations other than turning on/off this unit cannot be performed. Wait until the blinking stops.



- For a sampling frequency of the connected device, refer to the operating instruction for the connected device.
- If you set the downsampling setting to “on”, audio from the analog terminal will also be downsampled.





## Operation sound setting

You can turn the beep sound on/off.

### Touch [MODE].

- The mode indicator (amber) blinks.
  - Blinks once: on (default)
  - Blinks twice: off



- If the network indicator is blinking in blue and red, wait until the blinking stops.

## Wi-Fi signal strength

To check the Wi-Fi signal strength where the unit is located.  
If you are playing music on the network, stop the playback.

### Touch and hold both [-WPS] and [MODE].

- The mode indicator (amber) blinks once and then blinks again to show the Wi-Fi signal strength.
  - If the mode indicator (amber) does not blink again, the unit is not connected to the network.

Number of blinks	Wi-Fi signal strength
1	Weak
2	
3	Strong



- If the network indicator is blinking in blue and red, wait until the blinking stops.
- If the Wi-Fi signal strength cannot be checked, deselect the unit from AllPlay/DLNA speakers, and try again.



## IP/MAC address

To check the unit's IP address and the MAC address.

### Preparation

- Download the app “Panasonic Music Streaming”. (→ 19)

**1 Start the app “Panasonic Music Streaming”.**

**2 iOS** : Select “(⏮)”.

**Android** : Select “Select Speaker”.

**3 Select “GROUP”.**

e.g.,

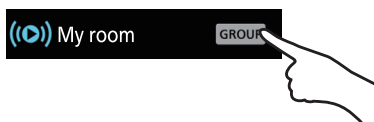

**4 Touch and hold “Group” in the title bar at the top.**

e.g.,

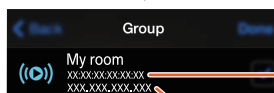

MAC address  
IP address



- This unit will be displayed as “Panasonic ALL1C” if the device name is not set.
- If the network indicator is blinking in blue and red, wait until the blinking stops.



# Troubleshooting

Before requesting service, make the following checks.  
If the problem remains unresolved, consult your dealer for instructions.

## For the U.S.A. and Canada

Refer to the limited warranty on the “Owner’s Manual <Setup>”.

### Do you have the latest firmware installed?

- Panasonic is constantly improving the unit’s firmware to ensure that our customers are enjoying the latest technology. (→ 23)

## General

### To return all settings to the factory defaults

- ① Turn this unit on.
  - If the network indicator is blinking in blue and red, proceed to the next step after the blinking stops.
- ② Touch and hold [⏻/I].
  - The operation indicator (amber) starts to blink.
- ③ While continuing to hold [⏻/I], touch [-WPS].
  - The mode indicator (amber) blinks 4 times.

---

### Humming heard during playback.

- There are cords of other appliances or fluorescent light near the unit’s AC power supply cord (AC mains lead). Turn the appliances off or keep them away from the AC power supply cord (AC mains lead).

---

### Cannot hear an audio from a device connected with an optical cable.

- Audio will not be heard if a device connected to this unit with an optical cable does not support the sampling frequency of the audio being output from this unit. Downsample the audio using this unit.  
(→ 24, “Downsampling”)



---

**The network indicator does not stop blinking in blue and red.**

- The unit needs to be repaired. Consult your dealer.
- 

**This unit has stopped producing operation sounds.**

- Set the operation sound setting to on. (→ 25)
- 

## Firmware updates

**The mode indicator (amber) keeps blinking twice.**

- This unit is not connected to the network. Touch any switch, and then check the network connection. (→ 12)
- 

**The mode indicator (amber) keeps blinking three times.**

- The update has been failed. Touch any switch, and then try again.
- 

**The mode indicator (amber) keeps blinking fast.**

- An error has occurred. Disconnect the AC power supply cord (AC mains lead) and reconnect it. Turn the unit on and try again.
- 

## Network

**The network indicator (red) keeps blinking.**

- This unit is not connected to the network. Check the network connection. (→ 12)
- 

**Cannot connect to the network.**

- This unit's Wi-Fi security supports WPA2™ only. Use a wireless router that provides a WPA2™ connection. For details on security supported by the router, refer to the operating instructions of the router.
- If the network is set to be invisible, make the network visible while you set up the network for this unit or make a wired LAN connection. (→ 17)
- Make sure that the multicast function on the wireless router is enabled.
- Depending on the routers, WPS button may not work. Try other methods. (→ 12)



---

**The device name is not changed.**

- Turn the unit off, and then disconnect and reconnect the AC power supply cord (AC mains lead).

---

**Cannot select this unit as the output speakers.**

- Make sure that the devices are connected to the same network as this unit.
- Reconnect the devices to the network.
- Turn off and then on the wireless router.

---

**Playback does not start.****The sound is interrupted.**

- If using the 2.4 GHz band on the wireless router, simultaneous use with other 2.4 GHz devices, such as microwaves, cordless telephones, etc., may result in connection interruptions. Increase the distance between this unit and these devices.
  - If your wireless router supports 5 GHz band, try using the 5 GHz band. To change to the 5 GHz band, restore the factory defaults (→ 27), and redo the network settings using an Internet browser (→ 13). On the step 6, make sure to select your network name (SSID) for the 5 GHz band.
- Do not place this unit inside a metal cabinet, for it might block the Wi-Fi signal.
- Place this unit closer to the wireless router.
- If several wireless devices are simultaneously using the same network as this unit, try turning off the other devices or reducing their network usage.
- Reconnect the devices to the network.
- Turn off and then on the wireless router.
- Try a wired LAN connection. (→ 17)



# Specifications

## ■ GENERAL

### Power supply

For the U.S.A. and Canada

AC 120 V, 60 Hz

For the United Kingdom and Ireland

For Continental Europe

For Australia and New Zealand

AC 220 V to 240 V, 50 Hz

### Power consumption

3 W

### Power consumption in standby mode

Approx. 2.5 W

## Dimensions (W×H×D)

### Horizontal installation

135 mm×51 mm×142 mm  
(5 11/32" × 2 1/32" × 5 19/32")

### Vertical installation with stand

71 mm×142 mm×142 mm  
(2 13/16" × 5 19/32" × 5 19/32")

## Mass (Weight)

Approx. 0.34 kg (0.75 lbs)

### With stand

Approx. 0.35 kg (0.78 lbs)

## Operating temperature range

0 °C to +40 °C (+32 °F to +104 °F)

## Operating humidity range

20 % to 80 % RH (no condensation)

## ■ Wi-Fi SECTION

### WLAN Standard

IEEE802.11a/b/g/n

### Frequency range

2.4 GHz band / 5 GHz band

### Security

WPA2™

### WPS version

Version 2.0

## ■ TERMINALS SECTION

### LAN port

10 Base-T/100 Base-TX



## ■ AUDIO SECTION

### ANALOG AUDIO OUTPUT

Output Level (1 kHz, 0 dB)	Stereo Pin jack
Frequency Response (fs 192 kHz)	2 Vrms
Signal to Noise Ratio (IHF-A) (1 kHz, 0 dB, fs 192 kHz)	4 Hz to 80 kHz, -3dB
Total Harmonic Distortion Plus Noise (1 kHz, 0 dB, fs 192 kHz)	102 dB or more
	0.005 % or less

### DIGITAL AUDIO OUTPUT

Optical

## ■ Audio support format (AllPlay)

### MP3/AAC

Sampling frequency	32/44.1/48 kHz
Audio word size	16 bit
Channel count	2 ch
Bit-rate	8-320 kbps

### FLAC/ALAC/WAV

Sampling frequency	32/44.1/48/88.2/96/176.4/192 kHz
Audio word size	16 bit, 24 bit
Channel count	2 ch

## ■ Audio support format (DLNA)

### MP3

Sampling frequency	32/44.1/48 kHz
Audio word size	16 bit
Channel count	2 ch
Bit-rate	8-320 kbps

### FLAC/WAV

Sampling frequency	32/44.1/48/88.2/96/176.4/192 kHz
Audio word size	16 bit, 24 bit
Channel count	2 ch



- Specifications are subject to change without notice.
- Mass and dimensions are approximate.
- Uncompressed FLAC files may not operate correctly.

Qualcomm® AllPlay™ smart media platform is a product of Qualcomm Connected Experiences, Inc. Qualcomm is a trademark of Qualcomm Incorporated, registered in the United States, and other countries and used with permission. AllPlay and the AllPlay icon are trademarks of Qualcomm Connected Experiences, Inc., and used with permission.

This product incorporates Spotify software which is subject to 3rd party licenses found here: [www.spotify.com/connect/third-party-licenses](http://www.spotify.com/connect/third-party-licenses)

Google Play and Android are trademarks of Google Inc.

DLNA, the DLNA Logo and DLNA CERTIFIED are trademarks, service marks, or certification marks of the Digital Living Network Alliance.

App Store is a service mark of Apple Inc.



The Wi-Fi CERTIFIED Logo is a certification mark of the Wi-Fi Alliance. The Wi-Fi Protected Setup Mark is a mark of the Wi-Fi Alliance. “Wi-Fi”, “Wi-Fi Protected Setup” and “WPA2” are marks or registered marks of the Wi-Fi Alliance.

Windows is a trademark or a registered trademark of Microsoft Corporation in the United States and other countries.

MPEG Layer-3 audio coding technology licensed from Fraunhofer IIS and Thomson.





## For the United Kingdom and Ireland customers

### Sales and Support Information

#### Customer Communications Centre

- For customers within the UK: 0844 844 3899
- For customers within Ireland: 01 289 8333
- Monday–Friday 9:00 am – 5:00 pm  
(Excluding public holidays).
- For further support on your product, please visit our website:  
[www.panasonic.co.uk](http://www.panasonic.co.uk)

#### Direct Sales at Panasonic UK

- Order accessory and consumable items for your product with ease and confidence by phoning our Customer Communications Centre Monday–Friday 9:00 am – 5:00 pm  
(Excluding public holidays).
- Or go on line through our Internet Accessory ordering application at  
[www.pas-europe.com](http://www.pas-europe.com).
- Most major credit and debit cards accepted.
- All enquiries transactions and distribution facilities are provided directly by Panasonic UK.
- It couldn't be simpler!
- Also available through our Internet is direct shopping for a wide range of finished products. Take a browse on our website for further details.

## For Canada

This device is restricted to indoor use due to its operation in the 5.15 to 5.25 GHz frequency range.

High-power radars are allocated as primary users (i.e. priority users) of the bands 5.25 to 5.35 GHz and 5.65 to 5.85 GHz and that these radars could cause interference and/or damage to LE-LAN devices.

The maximum antenna gain permitted for the device is 4.3 dBi, to comply with the EIRP limit in 5250-5350 MHz, 5470-5725 MHz, and 5725-5825 MHz specified for point-to-point operation.

Manufactured by: Panasonic Corporation  
Kadoma, Osaka, Japan  
Importer for Europe: Panasonic Marketing Europe GmbH  
Panasonic Testing Centre  
Winsbergring 15, 22525 Hamburg, Germany

---

**For the U.S.A.**

**Panasonic Corporation of  
North America**

Two Riverfront Plaza, Newark, NJ  
07102-5490

***<http://www.panasonic.com>***

**For Canada**

**Panasonic Canada Inc.**

5770 Ambler Drive,  
Mississauga, Ontario,  
L4W 2T3

***[www.panasonic.com](http://www.panasonic.com)***

**For the United Kingdom and Ireland**

**For Continental Europe**

**For Australia and New Zealand**

**Panasonic Corporation**

**Web Site:** <http://panasonic.net>