

# Panasonic®

English

Model No.

**Australia**

TH-L32XV6A  
TH-L39EV6A

**New Zealand**

TH-L32XV6Z  
TH-L39EV6Z

## Operating Instructions LED TV



# VIERA

## Contents

### Be Sure to Read

Important Notice .....	2
Safety Precautions .....	3

### Quick Start Guide

Accessories .....	5
Connections .....	7
Identifying Controls .....	11
First time Auto Tuning .....	13

### Using your VIERA

Watching TV .....	13
How to Use eHELP .....	14

### Others

FAQs .....	15
Maintenance .....	15
Specifications .....	16

For more detailed instructions, refer to [eHELP]  
(Built-in Operating Instructions).

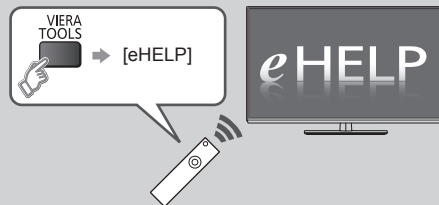

• How to use [eHELP] ➔ (p. 14)

Thank you for purchasing this Panasonic product.  
Please read these instructions carefully before operating this product and  
retain them for future reference.  
The images shown in this manual are for illustrative purposes only.





- For the information of the trademarks, refer to [eHELP] (Support > Licence).

## Important Notice

Panasonic does not guarantee operation and performance of peripheral devices made by other manufacturers; and we disclaim any liability or damage arising from operation and/or performance from usage of such other maker's peripheral devices.

The recording and playback of content on this or any other device may require permission from the owner of the copyright or other such rights in that content. Panasonic has no authority to and does not grant you that permission and explicitly disclaims any right, ability or intention to obtain such permission on your behalf. It is your responsibility to ensure that your use of this or any other device complies with applicable copyright legislation in your country. Please refer to that legislation for more information on the relevant laws and regulations involved or contact the owner of the rights in the content you wish to record or playback.

This product is licensed under the AVC patent portfolio license for the personal and non-commercial use of a consumer to (i) encode video in compliance with the AVC Standard ("AVC Video") and/or (ii) decode AVC Video that was encoded by a consumer engaged in a personal and non-commercial activity and/or was obtained from a video provider licensed to provide AVC Video. No license is granted or shall be implied for any other use. Additional information may be obtained from MPEG LA, LLC. See <http://www.mpegla.com>.

Panasonic and its affiliates make no representations or warranties of any kind with respect to the USB devices and the performance of communication between the USB devices and the USB port of Panasonic products, and expressly disclaims any and all warranties, whether express or implied or otherwise, including without limitation any implied warranty of fitness for a particular purpose, any loss of data, and any implied warranties arising from course of dealing or course of performance of data communication between the USB devices and the USB port of Panasonic products.

Transport only in upright position

# Safety Precautions

To help avoid risk of electrical shock, fire, damage or injury, please follow the warnings and cautions below:

## ■ Mains plug and lead

### Warning

If you detect anything unusual, immediately remove the mains plug.

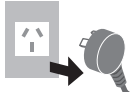

- This TV is designed to operate on AC 220-240 V, 50 / 60 Hz.
- Insert the mains plug fully into the socket outlet.
- Ensure that the mains plug is easily accessible.
- Disconnect the mains plug when cleaning the TV.
- Do not touch the mains plug with wet hands.



- Do not damage the mains lead.
  - Do not place a heavy object on the lead.



- Do not place the lead near a high temperature object.



- Do not pull on the lead. Hold onto the mains plug body when disconnecting the plug.



- Do not move the TV with the lead plugged into a socket outlet.
- Do not twist the lead, bend it excessively or stretch it.
- Do not use a damaged mains plug or socket outlet.
- Ensure the TV does not crush the mains lead.
- Do not use any mains lead other than that provided with this TV.

## ■ Take care

### Warning

- Do not remove covers and never modify the TV yourself as live parts are accessible when they are removed. There are no user serviceable parts inside.
- Do not expose the TV to rain or excessive moisture. This TV must not be exposed to dripping or splashing water and objects filled with liquid, such as vases, must not be placed on top of or above the TV.
- Do not insert foreign objects into the TV through the air vents.
- Do not use an unapproved pedestal / mounting equipment. Be sure to ask your local Panasonic dealer to perform the setup or installation of approved wall-hanging brackets.
- Do not apply strong force or impact to the display panel.
- Do not place the TV on sloped or unstable surfaces, and ensure that the TV does not hang over the edge of the base.



## Important information

If the TV is not positioned in a sufficiently stable location, it can be potentially hazardous due to falling. Many injuries, particularly to children, can be avoided by taking simple precautions such as:

- Using cabinets or stands recommended by the manufacturer of the TV.
- Only using furniture that can safely support the TV.
- Ensuring the TV is not overhanging the edge of the supporting furniture.
- Not placing the TV on tall furniture (for example, cupboards or bookcases) without anchoring both the furniture and the TV to a suitable support.
- Not standing the TV on cloth or other materials placed between the TV and supporting furniture.
- Educating children about the dangers of climbing on furniture to reach the TV or its controls.

- This TV is designed for indoor use.
- This TV is designed for table-top use.
- Do not expose the TV to direct sunlight and other sources of heat.



**To prevent the spread of fire, keep candles or other open flames away from this product at all times**



## ■ Dangerous part / Small object

### Warning

- This product contains possibly dangerous parts such as plastic bags, that can be breathed in or swallowed by young children accidentally. Keep these parts out of reach of young children.

## ■ Pedestal

### Warning

- Do not disassemble or modify the pedestal.

### Caution

- Do not use any pedestal other than the one provided with this TV.
- Do not use the pedestal if it becomes warped or physically damaged. If this occurs, contact your nearest Panasonic dealer immediately.
- During setup, make sure that all screws are securely tightened.
- Ensure that the TV does not suffer any impact during installation of the pedestal.
- Ensure that children do not climb onto the pedestal.
- Install or remove the TV from the pedestal with at least two people.
- Install or remove the TV by the specified procedure.

## ■ Radio wave

### Warning

- Do not use the TV in any medical institutions or locations with medical equipment. Radio waves may interfere with the medical equipment and cause accidents due to the malfunction.
- Do not use the TV near any automatic control equipment such as automatic doors or fire alarms. Radio waves may interfere with the automatic control equipment and cause accidents due to the malfunction.
- Keep the distance at least 22 cm from the TV when you have a cardiac pacemaker. Radio waves may interfere with the operation of the pacemaker.
- Do not disassemble or alter the TV in any way.

## ■ Built-in wireless LAN

### Caution

- Do not use the built-in wireless LAN to connect to any wireless network (SSID\*) for which you do not have usage rights. Such networks may be listed as a result of searches. However, using them may be regarded as illegal access.  
\*SSID is a name for identifying a particular wireless network for transmission.
- Do not subject the built-in wireless LAN to high temperatures, direct sunlight or moisture.
- Data transmitted and received over radio waves may be intercepted and monitored.
- The built-in wireless LAN uses 2.4 GHz and 5 GHz frequency bands. To avoid malfunctions or slow response caused by radio wave interference, keep the TV away from the devices such as other wireless LAN devices, microwaves, mobile phones and the devices that use 2.4 GHz and 5 GHz signals when using the built-in wireless LAN.
- When noises occur due to the static electricity, etc., the TV might stop operating for the protection of the devices. In this case, turn the TV off with Mains power On / Off switch, then turn it on again.
- Additional information for the wireless LAN and access point may be on the following website.  
<http://panasonic.net/viera/support>

## ■ Ventilation

### Caution

Allow sufficient space around the TV in order to help prevent excessive heat, which could lead to early failure of some electronic components.

Minimum distance:

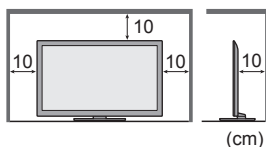

- Ventilation should not be impeded by covering the ventilation openings with items such as newspapers, tablecloths and curtains.
- Whether you are using a pedestal or not, always ensure the vents at the bottom of the TV are not blocked and there is sufficient space to enable adequate ventilation.



## ■ Moving the TV

### Caution

Before moving the TV, disconnect all cables.

- Move the TV with at least two people. Support as shown to avoid injury by the TV tipping or falling.



## ■ When not in use for a long time

### Caution

This TV will still consume some power even in the Off mode, as long as the mains plug is still connected to a live socket outlet.

- Remove the mains plug from the wall socket when the TV is not in use for a prolonged period of time.

## ■ Battery for the Remote Control

### Caution

- Incorrect installation may cause battery leakage, corrosion and explosion.
- Replace only with the same or equivalent type.
- Do not mix old and new batteries.
- Do not mix different battery types (such as alkaline and manganese batteries).
- Do not use rechargeable batteries (Ni-Cd, etc.).
- Do not burn or break up batteries.
- Do not expose batteries to excessive heat such as sunshine, fire or the like.
- Make sure you dispose of batteries correctly.

# Accessories

## Remote Control

→ (p. 11)



• N2QAYB000817

## Batteries (2)

• R6

→ (p. 11)



Operating Instructions with  
Warranty statement

## Pedestal

→ (see below)

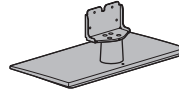

## Mains lead

→ (p. 7)

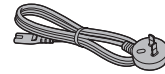

Fall-prevention parts  
→ (p. 6)

- Accessories may not be placed all together. Take care not to throw them away unintentionally.
- For the information of optional accessories, refer to [eHELP] (Support > Optional accessories).

## Assembling / Removing the pedestal

### (A) Assembly screw (4)



M5 × 16

### (B) Assembly screw (4)



M4 × 25

### (C) Bracket



### (D) Base

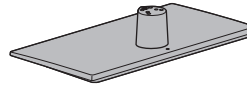

## ■ Assembling the pedestal

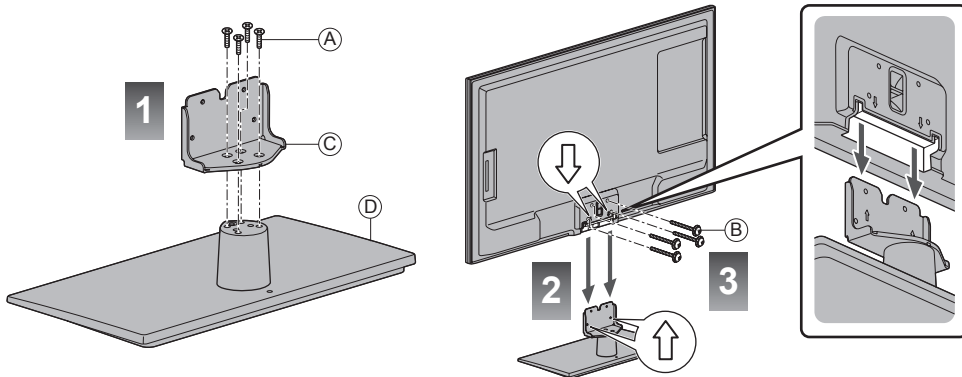

### ■ Preventing the TV from falling over

It is recommended to secure the pedestal to a furniture as shown to prevent the TV from falling over.

- This information is designed to reduce the risk of injuries caused by the TV falling over. However, no measure can guarantee protection in all cases.

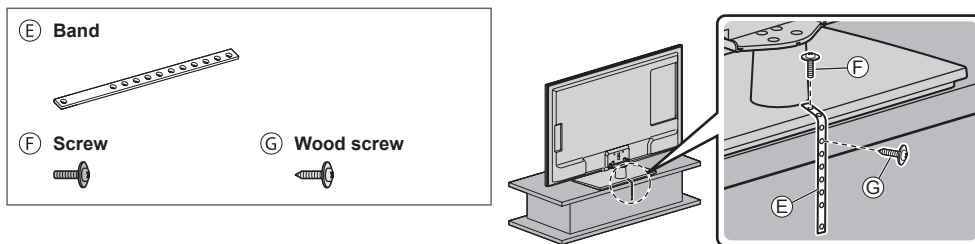

### Removing the pedestal from the TV

Be sure to remove the pedestal in the following way when using the wall-hanging bracket or repacking the TV.

- 1 Remove the assembly screws (B) from the TV.
- 2 Pull out the pedestal from the TV.
- 3 Remove the assembly screws (A) from the bracket.

# Connections

- External equipment and cables shown are not supplied with this TV.
- Ensure that the unit is disconnected from the mains socket before attaching or disconnecting any leads.
- Check the type of terminals and cable plugs are correct when connecting.
- Always use a fully wired HDMI cable.
- Keep the TV away from electronic equipment (video equipment, etc.) or equipment with an infrared sensor. Otherwise, distortion of image / sound may occur or operation of other equipment may be interfered.
- Also read the manual of the equipment being connected.

## Terminals

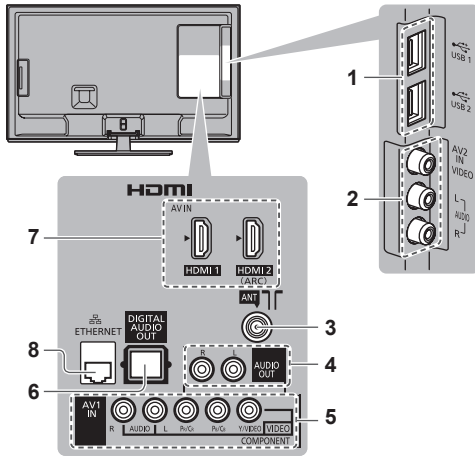

- 1 USB 1 - 2 port
- 2 AV2
- 3 Aerial terminal  
→ (see below)
- 4 AUDIO OUT
- 5 AV1 (COMPONENT / VIDEO)  
→ (p. 9)
- 6 DIGITAL AUDIO OUT
- 7 HDMI1 - 2 → (p. 8, 9)
- 8 ETHERNET → (p. 8)

## Basic connections

### Mains lead and aerial

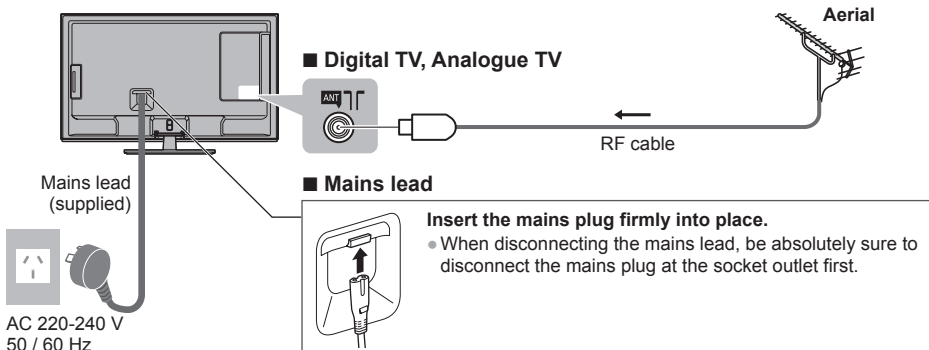

- Keep RF (aerial) cable away from the mains lead to avoid and minimise mains interference pickup.
- Do not place the RF cable under the TV.
- An aerial, correct cable (75  $\Omega$  coaxial) and correct terminating plug are required to obtain optimum quality picture and sound.
- If a communal aerial system is used, you may require the correct connection cable and plug between the wall aerial socket and the TV.
- Your local Television Service Centre or dealer may be able to assist you in obtaining the correct aerial system for your particular area and the accessories required.
- Any matters regarding aerial installation, upgrading of existing systems or accessories required, and the costs incurred, are the responsibility of you, the customer.

## AV devices

### ■ DVD Recorder / VCR

TV

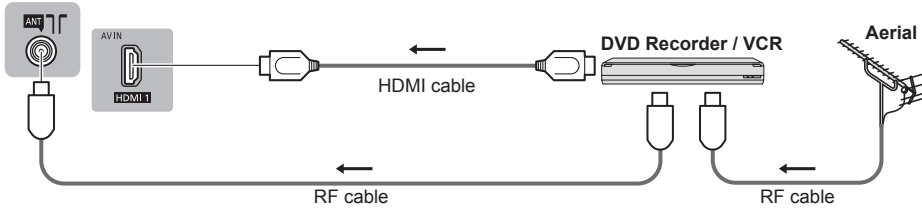

### ■ Set top box

TV

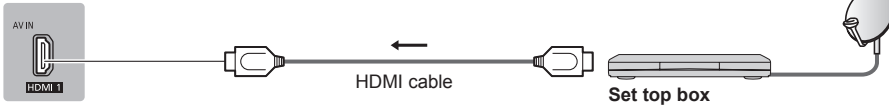

## Network

- To enable the network service functions (VIERA Connect, etc.), you need to connect the TV to a broadband network environment. If you do not have any broadband network services, please consult your retailer for assistance.
- Prepare the internet environment for wired connection or wireless connection.
- Setup of the network connection will start when first using the TV. ➔(p. 13)

### ■ Wired connection

TV

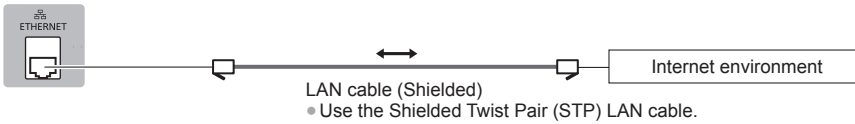

### ■ Wireless connection

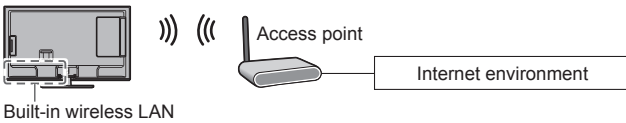



## Other connections

### ■ DVD player (COMPONENT equipment)

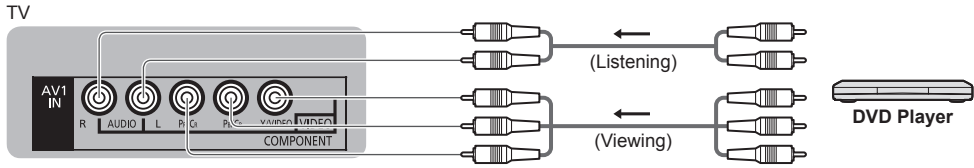

### ■ Camcorder / Game equipment (VIDEO equipment)

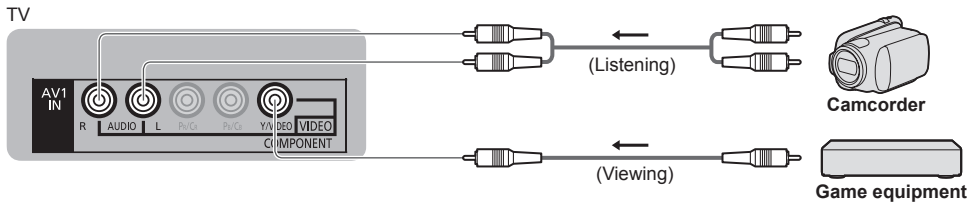



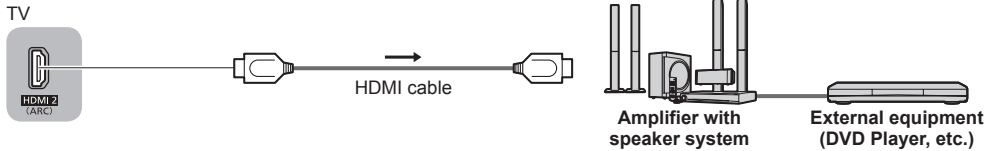



### ■ Amplifier (to listen with speakers)



- Use HDMI2 for connecting an amplifier. This connection is applicable when using an amplifier that has ARC (Audio Return Channel) function.  
As for an amplifier without ARC function, use DIGITAL AUDIO OUT.
- To enjoy the sound from the external equipment in multi-channel sound (e.g. Dolby Digital 5.1ch), connect the equipment to the amplifier. For the connections, read the manuals of the equipment and amplifier.

**Types of connectable equipment to each terminal**

Features	Terminal						
	AV1		AV2	AUDIO OUT	DIGITAL AUDIO OUT	ETHERNET	HDMI 1 - 2
	COMPONENT	VIDEO					
							
To play back videocassettes / DVDs (VCR / DVD Player)	○	○	○				○
To watch satellite broadcasts (Set top box)		○	○				○
To watch camcorder images (Video camera)		○	○				○
To play games (Game equipment)		○	○				○
To use amplifier with speaker system				○	○		○*
To use network services						○	
VIERA Link							○

○ : Recommended Connection

\*: Use HDMI2 for connecting an amplifier. This connection is applicable when using an amplifier that has ARC (Audio Return Channel) function.

# Identifying Controls

## Remote Control

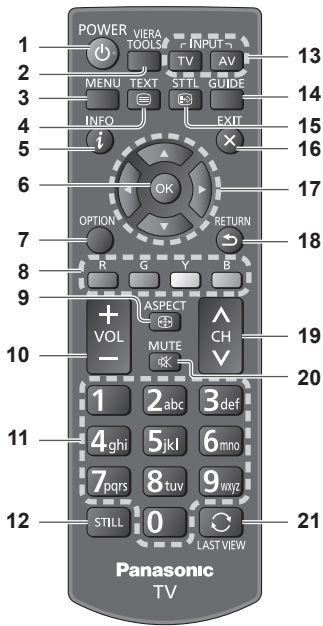

### 1 Standby On / Off switch

### 2 VIERA TOOLS

- Displays some special feature icons and accesses easily.

### 3 [Main Menu]

- Press to access Picture, Sound, Network, Timer, Setup and Help Menus.

### 4 Teletext button

- This button is not used for this model. (Australia)
- Switches to teletext mode. (New Zealand)

### 5 Information

- Displays channel and programme information.

### 6 OK

- Confirms selections and choices.
- Press after selecting channel positions to quickly change channel.
- Displays the Channel List.

### 7 [Option Menu]

- Easy optional setting for viewing, sound, etc.

### 8 Coloured buttons (red-green-yellow-blue)

- Used for the selection, navigation and operation of various functions.

### 9 Aspect

- Changes aspect ratio.

### 10 Volume Up / Down

### 11 Numeric buttons

- Changes channel. (Australia)
- Changes channel and teletext pages. (New Zealand)
- Sets characters.
- When in Standby mode, switches TV on.

### 12 STILL

- Freeze / unfreeze picture.

### 13 Input mode selection

- TV - switches to Digital TV / Analogue TV.
- AV - switches to AV input mode from Input Selection list.

### 14 TV Guide (Australia)

### Freeview Guide (New Zealand)

### 15 Subtitles

- Displays subtitles.

### 16 Exit

- Returns to the normal viewing screen.

### 17 Cursor buttons

- Makes selections and adjustments.

### 18 Return

- Returns to the previous menu / page.

### 19 Channel Up / Down

### 20 Sound Mute On / Off

### 21 Last view

- Switches to previously viewed channel or input mode.

## ■ Installing / Removing batteries

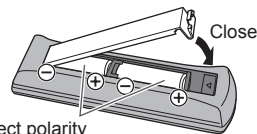
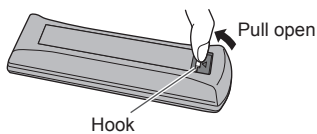

Note the correct polarity (+ or -)

## Indicator / Control panel

- When pressing 1, 2, 3 buttons, the control panel guide appears on the right side of the screen for 3 seconds to highlight the pressed button.

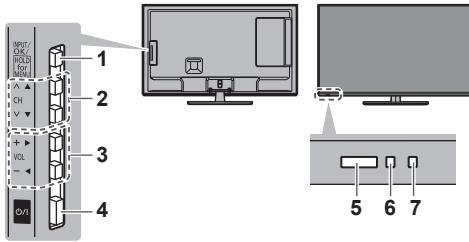

Rear side of the TV

### 1 Input mode selection

- Press repeatedly until you reach the desired mode.

#### [Main Menu]

- Press and hold for about 3 seconds to display main menu.

**OK** (when in the menu system)

### 2 Channel Up / Down

- Cursor Up / Down (when in the menu system)

### 3 Volume Up / Down

- Cursor Left / Right (when in the menu system)

### 4 Mains power On / Off switch

- Use to switch the mains power.

### 5 Remote control signal receiver

- Do not place any objects between the TV remote control signal receiver and remote control.

### 6 Ambient sensor

- Senses brightness to adjust picture quality when [Ambient Sensor] in the Picture Menu is set to [On].

### 7 Power LED

**Red:** Standby

**Green:** On

- The LED blinks when the TV receives a command from the remote control.

## Using the On Screen Displays - Operation guide

Many features available on this TV can be accessed via the On Screen Display menu.

### ■ Operation guide

Operation guide will help your operation by using the remote control.

Example: [Sound Menu]

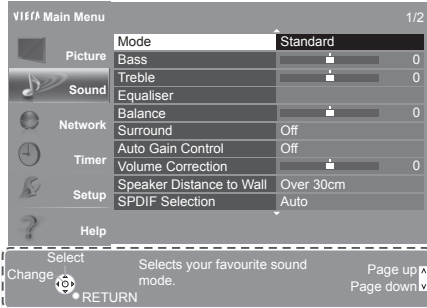

Operation guide

### ■ How to use remote control



Open the main menu



Move the cursor / select from a range of options / select the menu item (up and down only) / adjust levels (left and right only)



Access the menu / store settings after adjustments have been made or options have been set

RETURN



Return to the previous menu



Exit the menu system and return to the normal viewing screen

# First time Auto Tuning

Automatically sets up the TV and searches for available TV channels when the TV is turned on for the first time.

- These steps are not necessary if the setup has been completed by your local dealer.
- Please complete connections (p. 7 - 10) and settings (if necessary) of the connected equipment before starting Auto Tuning. For details of settings for the connected equipment, read the manual of the equipment.

## 1 Plug the TV into mains socket and turn power on

POWER • Takes a few seconds to be displayed.



## 2 Select the following items

Set up each item by following the on-screen instructions.

### Select [Home]

Select [Home] viewing environment to use in your home environment.

- [Shop] is for shop display.
- To change viewing environment later on, you will need to initialise all settings by accessing Shipping Condition.

### Set up the network connection

Select your area (Australia)

Tick the TV signal mode to tune, and then select [Start Auto Tuning]

: tune (search for the available channels)

: skip tuning

**Auto Tuning is now complete and your TV is ready for viewing.**

If tuning has failed, check the connection of the network, RF cable, and then follow the on-screen instructions.

### Note

- The TV will automatically go into Standby mode when no operation is performed for 4 hours if [Auto Standby] in the Timer Menu is set to [On].
- The TV will automatically go into Standby mode when no signal is received and no operation is performed for 10 minutes if [No signal Power off] in the Timer Menu is set to [On].
- To retune all channels → [Auto Tuning] in [Tuning Menu] (Setup Menu)
- To add the available TV signal mode later → [Add TV Signal] in [Tuning Menu] (Setup Menu)
- To initialise all settings → [Shipping Condition] in [System Menu] (Setup Menu)

# Watching TV

## 1 Turn power on

⏻/I (TV)

or

POWER



• Mains power On / Off switch should be on. (p. 12)  
(Remote Control)

## 2 Select Digital TV or Analogue TV

TV

## 3 Select a channel

▲ up  
CH  
▼ down

or

1 2 3 4 5 6 7 8 9 0  
3 def 9 m 9 ms

• To select 2 or more-digit channel position number, e.g. 399

# How to Use eHELP

[eHELP] is the detailed operating instructions built into the TV, and helps you to get more understanding of the operations for each feature.

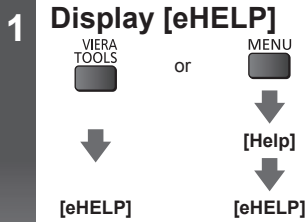

- [Read first] will be displayed on the top page. Please read these instructions fully to get more understanding of the operation in [eHELP].
- If this is not the first time to view [eHELP] from when the TV is turned on, the confirmation screen is displayed to select whether [First Page] or [Last Page].

## 2 Select the category and item

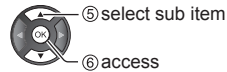
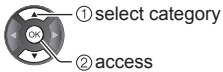
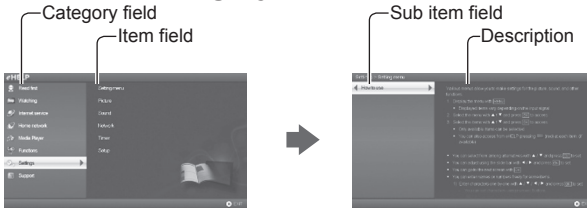

- To return to the previous field



- To scroll the description (if more than 1 page)  
While the description is highlighted



- To display the menu related to the description (only for some descriptions)



# FAQs

Before requesting service or assistance, please follow these simple guides to solve the problem.

- For more information, refer to [eHELP] (Support > FAQs).

## The TV does not switch on

- Check the mains lead is plugged into the TV and the socket outlet.

## The TV goes into Standby mode

- Auto power standby function is activated.

## The remote control does not work or is intermittent

- Are the batteries installed correctly? ➔ (p. 11)
- Has the TV been switched on?
- The batteries may be running low. Replace them with new ones.
- Point the remote control directly at the TV's remote control signal receiver (within about 7 m and a 30 degree angle of the signal receiver).
- Situate the TV away from sunshine or other sources of bright light not to shine on the TV's remote control signal receiver.

## No image can be displayed

- Check the TV is turned on.
- Check the mains lead is plugged into the TV and the socket outlet.
- Check the correct input mode is selected.
- Check the setting of [AV1] ([COMPONENT] / [VIDEO]) in [Input Selection] to match the output of the external equipment.
- Is [Contrast], [Brightness] or [Colour] in the Picture Menu set to the minimum?
- Check all required cables and connections are firmly in place.

## Unusual image is displayed

- Turn the TV off with Mains power On / Off switch, then turn it on again.
- If the problem persists, initialise all settings. ➔ [Shipping Condition] in [System Menu] (Setup Menu)

## Parts of the TV become hot

- Even if the temperature of parts of the front, top and rear panels has risen, these temperature rises do not cause any problems in terms of performance or quality.

## The LCD panel moves slightly and clattered sound is heard when it is pushed with a finger

- There is some flexibility around the panel to prevent damage to the panel. This is not a malfunction.

# Maintenance

First, remove the mains plug from the socket outlet.

## Display panel, Cabinet, Pedestal

### Regular care:

Gently wipe the surface of the display panel, cabinet, or pedestal by using a soft cloth to clean the dirt or fingerprints.

### For stubborn dirt:

First clean the dust on the surface. Dampen a soft cloth with clean water or diluted neutral detergent (1 part detergent to 100 parts water). Wring the cloth and wipe the surface. Finally, wipe away all the moisture.

### Caution

- Do not use a hard cloth or rub the surface too hard, otherwise this may cause scratches on the surface.
- Take care not to subject the TV's surfaces to water or detergent. Liquid inside the TV could lead to product failure.
- Take care not to subject the surfaces to insect repellent, solvent, thinner or other volatile substances. This may degrade surface quality or cause peeling of the paint.
- The surface of the display panel is specially treated and may be easily damaged. Take care not to tap or scratch the surface with your fingernail or other hard objects.
- Do not allow the cabinet and pedestal to make contact with a rubber or PVC substance for a long time. This may degrade surface quality.

## Mains plug

Wipe the mains plug with a dry cloth at regular intervals. Moisture and dust may cause fire or electrical shock.

# Specifications

		XV6 series	EV6 series
<b>Model No.</b>		TH-L32XV6A TH-L32XV6Z	TH-L39EV6A TH-L39EV6Z
<b>Power</b>	<b>Rating</b>	AC 220-240 V, 50 / 60 Hz 0.57 A	AC 220-240 V, 50 / 60 Hz 0.36 A
	<b>Normal (Home) mode</b>	35 W	38 W
	<b>Standby power consumption</b>	0.25 W	0.2 W
<b>Visible screen size (diagonal)</b>		80 cm	98 cm
<b>Display resolution</b>		1,366 (W) × 768 (H)	1,920 (W) × 1,080 (H)
<b>Panel</b>		LED backlight Liquid Crystal Display	
<b>Sound</b>	<b>Speaker</b>	(90 mm × 25 mm) × 2, 8 Ω	(90 mm × 22 mm) × 2, 8 Ω
	<b>Audio output</b>	10 W (5 W + 5 W)	20 W (10 W + 10 W)
<b>Dimensions (W × H × D)</b>		731 mm × 493 mm × 207 mm (With Pedestal) 731 mm × 439 mm × 59 mm (TV only)	879 mm × 573 mm × 217 mm (With Pedestal) 879 mm × 519 mm × 49 mm (TV only)
<b>Mass</b>		8.0 kg Net (With Pedestal) 7.0 kg Net (TV only)	13.0 kg Net (With Pedestal) 11.0 kg Net (TV only)

		Australia	New Zealand
<b>Model No.</b>		TH-L32XV6A TH-L39EV6A	TH-L32XV6Z TH-L39EV6Z
<b>Connection terminals</b>	<b>AV1 IN (COMPONENT / VIDEO)</b>	<b>VIDEO</b> RCA PIN Type × 1	1.0 V[p-p] (75 Ω)
		<b>AUDIO L - R</b> RCA PIN Type × 2	0.5 V[rms]
		<b>Y</b> 1.0 V[p-p] (including synchronisation) <b>Pb/Cb, Pr/Cr</b> ±0.35 V[p-p]	
	<b>AV2 IN</b>	<b>VIDEO</b> RCA PIN Type × 1	1.0 V[p-p] (75 Ω)
		<b>AUDIO L - R</b> RCA PIN Type × 2	0.5 V[rms]
	<b>AUDIO OUT</b>	<b>AUDIO L - R</b> RCA PIN Type × 2	0.5 V[rms]
	<b>HDMI 1 / 2 input</b>	TYPE A Connectors HDMI 1: Content Type HDMI 2: Content Type, Audio Return Channel • This TV supports "HDAVI Control 5" function.	
	<b>ETHERNET</b>	10BASE-T / 100BASE-TX	
	<b>USB 1 / 2</b>	USB 2.0 DC 5 V, Max. 500 mA	
	<b>DIGITAL AUDIO OUT</b>	PCM / Dolby Digital / DTS, Fibre optic	
<b>Receiving systems / Band name</b>	<b>Digital TV</b>	7 MHz VHF / UHF (Australia) free-to-air TV broadcast reception	8 MHz UHF (New Zealand) free-to-air TV broadcast reception
	<b>PAL B / G</b>	Reception of Off air broadcasts	
	<b>PAL 60 Hz</b>	Playback of NTSC tape from some PAL Video recorders (VCR)	
	<b>M.NTSC</b>	Playback from M.NTSC Video recorders (VCR)	
	<b>NTSC</b>	Playback from NTSC Video recorders (VCR)	
<b>Aerial input</b>		Standard Belling & Lee connector VHF / UHF	



<b>Operating conditions</b>	<b>Temperature:</b> 0 °C - 35 °C <b>Humidity:</b> 20 % - 80 % RH (non-condensing)
<b>Built-in wireless LAN</b>	<b>Standard compliance and Frequency range*:</b> IEEE802.11a/n 5.15 GHz - 5.35 GHz, 5.47 GHz - 5.85 GHz IEEE802.11b/g/n 2.40 GHz - 2.4835 GHz
	<b>Security:</b> WPA2-PSK (TKIP/AES) WPA-PSK (TKIP/AES) WEP (64 bit/128 bit)

\* The frequency and channel differ depending on the country.

**Note**

- Design and Specifications are subject to change without notice. Mass and Dimensions shown are approximate.
- For the information of the open source software, refer to [eHELP] (Support > Licence).

**■ When using the wall-hanging bracket**

- Choosing to wall mount the TV shall be done at the owner's risk. Always use a qualified installer to perform a TV wall bracket installation. Incorrect fitting may cause equipment to fall, resulting in injury and product damage. Any such damage will void your warranty.

32-inch model

**a: 200 mm**  
**b: 100 mm**

39-inch model

**a: 200 mm**  
**b: 200 mm**

- Holes for wall-hanging bracket installation

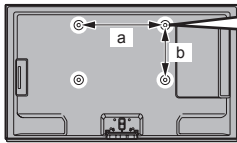

Rear of the TV

**Depth of screw**

32-inch model

**minimum: 24 mm**  
**maximum: 25 mm**

39-inch model

**minimum: 17 mm**  
**maximum: 18 mm**

**Type of screw: M6**

Screw for fixing the TV onto the wall-hanging bracket (not supplied with the TV)

(View from the side)

## Panasonic Warranty

1. The product is warranted for 12 months from the date of purchase. Subject to the conditions of this warranty Panasonic or its Authorised Service Centre will perform necessary service on the product without charge for parts or labour, if in the opinion of Panasonic, the product is found to be faulty within the warranty period.
2. This warranty only applies to Panasonic products purchased in Australia and sold by Panasonic Australia or its Authorised Distributors or Dealers and only where the products are used and serviced within Australia or its territories. Warranty cover only applies to service carried out by a Panasonic Authorised Service Centre and only if valid proof of purchase is presented when warranty service is requested.
3. This warranty only applies if the product has been installed and used in accordance with the manufacturer's recommendations (as noted in the operating instructions) under normal use and reasonable care (in the opinion of Panasonic). The warranty covers normal domestic use only and does not cover damage, malfunction or failure resulting from use of incorrect voltages, incorrect installation, accident, misuse, neglect, build-up of dirt or dust, abuse, maladjustment of customer controls, mains supply problems, thunderstorm activity, infestation by insects or vermin, tampering or repair by unauthorised persons (including unauthorised alterations), introduction of sand, humidity or liquids, commercial use such as hotel, office, restaurant, or other business or rental use of the product, exposure to abnormally corrosive conditions or any foreign object or matter having entered the product.
4. This warranty does not cover the following items unless the fault or defect existed at the time of purchase:
 

(a) Cabinet Part(s)	(e) DVD, Blu-ray, or Recordable Discs
(b) Video or Audio Tapes	(f) Video / Audio Heads from wear and tear in normal use
(c) SD cards or USB devices	(g) Information stored on Hard Disk Drive, USB stick or SD card
(d) User replaceable Batteries	(h) DTV reception issues caused by TV Aerial / Cabling / Wall socket(s)

 etc
5. Some products may be supplied with Ethernet connection hardware. The warranty is limited on such products and will not cover
  - (a) Internet and or DLNA connection / setup related problems
  - (b) Access fees and or charges incurred for internet connection
  - (c) The use of incompatible software or software not specifically stipulated in the product operations manual; and
  - (d) Any indirect or consequential costs associated with the incorrect use or misuse of the hardware, its connection to the internet or any other device.
6. To claim warranty service, when required, you should:
  - Telephone Panasonic's Customer Care Centre on 132600 or visit our website referred to below and use the Service Centre Locator for the name/address of the nearest Authorised Service Centre.
  - Send or take the product to a Panasonic Authorised Service Centre together with your proof of purchase receipt as a proof of purchase date. Please note that freight and insurance to and / or from your nearest Authorised Service Centre must be arranged by you.
  - Note that home or pick-up/delivery service is available for the following products in the major metropolitan areas of Australia or the normal operating areas of the nearest Authorised Service Centres:
    - Plasma/LCD televisions / displays (screen size greater than 103 cm)
7. The warranties hereby conferred do not extend to, and exclude, any costs associated with the installation, de-installation or re-installation of a product, including costs related to the mounting, de-mounting or remounting of any screen, (and any other ancillary activities), delivery, handling, freighting, transportation or insurance of the product or any part thereof or replacement of and do not extend to, and exclude, any damage or loss occurring by reason of, during, associated with, or related to such installation, de-installation, re-installation or transit.

Panasonic Authorised Service Centres are located in major metropolitan areas and most regional centres of Australia, however, coverage will vary dependant on product. For advice on exact Authorised Service Centre locations for your product, please telephone our Customer Care Centre on 132600 or visit our website and use the Service Centre Locator.

In addition to your rights under this warranty, Panasonic products come with consumer guarantees that cannot be excluded under the Australian Consumer Law. If there is a major failure with the product, you can reject the product and elect to have a refund or to have the product replaced or if you wish you may elect to keep the goods and be compensated for the drop in value of the goods. You are also entitled to have the product repaired or replaced if the product fails to be of acceptable quality and the failure does not amount to a major failure.

If there is a major failure in regard to the product which cannot be remedied then you must notify us within a reasonable period by contacting the Panasonic Customer Care Centre. If the failure in the product is not a major failure then Panasonic may choose to repair or replace the product and will do so in a reasonable period of time from receiving notice from you.

**THIS WARRANTY CARD AND THE PURCHASE DOCKET (OR SIMILAR PROOF OF PURCHASE) SHOULD BE RETAINED BY THE CUSTOMER AT ALL TIMES**

If you require assistance regarding warranty conditions or any other enquiries, please visit the **Panasonic Australia** website **www.panasonic.com.au** or contact by phone on **132 600** *If phoning in, please ensure you have your operating instructions available.*

**Panasonic Australia Pty. Limited**

ACN 001 592 187 ABN 83 001 592 187

1 Innovation Road, Macquarie Park NSW 2113

PRO-031-F11 Issue: 4.0

01-01-2011

## **WARRANTY - New Zealand only**

WE WARRANT that the Panasonic Television that you have purchased is free from defects in material and workmanship under normal home use and service.

Accordingly, we undertake to repair, or at our option, replace without cost to the owner, either for material or labour, any part which within 12 months from the date of delivery is found to be defective, provided that the appliance has been used for domestic purposes only and in accordance with the instructions given in the Instruction Book and not been subjected to misuse, neglect or installed, dismantled, repaired or serviced by any other than an authorised Panasonic New Zealand Dealer or Panasonic New Zealand Authorised Service Centre.

**NOTE**

- Before reporting a fault, please ensure that you read the item "Troubleshooting" in the information section of your Panasonic Instruction Book.
- It is important to retain your proof of purchase as this will be required by the serviceman or retailer as proof of purchase date, should service be required.
- In the event of service being required, contact your Panasonic New Zealand retailer or Panasonic New Zealand Authorised Service Centre.

**IMPORTANT**

Any request for warranty service must be through an Authorised Panasonic New Zealand Service Centre who during the period of the warranty, undertakes to make any necessary adjustment and fit any replacement part supplied by the manufacturer, during normal working hours, or alternatively will arrange for such service to be provided by some other Panasonic New Zealand Authorised Service Centre.

## **NEW ZEALAND**

**Distributed in New Zealand by Panasonic New Zealand Limited**

**350 Te Irirangi Drive East Tamaki, Private Bag 14911, Panmure Auckland**

**Tel. 09 272 0100**

Customer Care Center

Email: [Customerservice@nz.panasonic.com](mailto:Customerservice@nz.panasonic.com)

[www.panasonic.co.nz](http://www.panasonic.co.nz)

### Information on Disposal in other Countries outside the European Union



This symbol is only valid in the European Union. If you wish to discard this product, please contact your local authorities or dealer and ask for the correct method of disposal.

### Customer's Record

The model number and serial number of this product may be found on its rear panel. You should note this serial number in the space provided below and retain this book, plus your purchase receipt, as a permanent record of your purchase to aid in identification in the event of theft or loss, and for Warranty Service purposes.

**Model Number**

**Serial Number**

**Panasonic Corporation**

Web Site: <http://panasonic.net>

M0113-0

© Panasonic Corporation 2013

Printed in Malaysia