

Panasonic®

Model No.

TH-L32D25A
TH-L37D25A
TH-L42D25A

Operating Instructions LCD TV

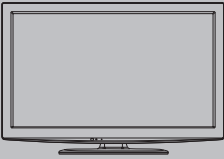

VIERA



Thank you for purchasing this Panasonic product. Please read these instructions before operating your set and retain them for future reference. The images shown in this manual are for illustrative purposes only.

English

ZN
TQB4GC0379-1

Experience an amazing level of multimedia excitement

Receive digital terrestrial services using an integrated Digital TV tuner
Sharp pictures with HDMI terminal
Create home theatre and DVD recorder link-ups with "VIERA Link"
without complicated settings!

Enjoy rich multimedia

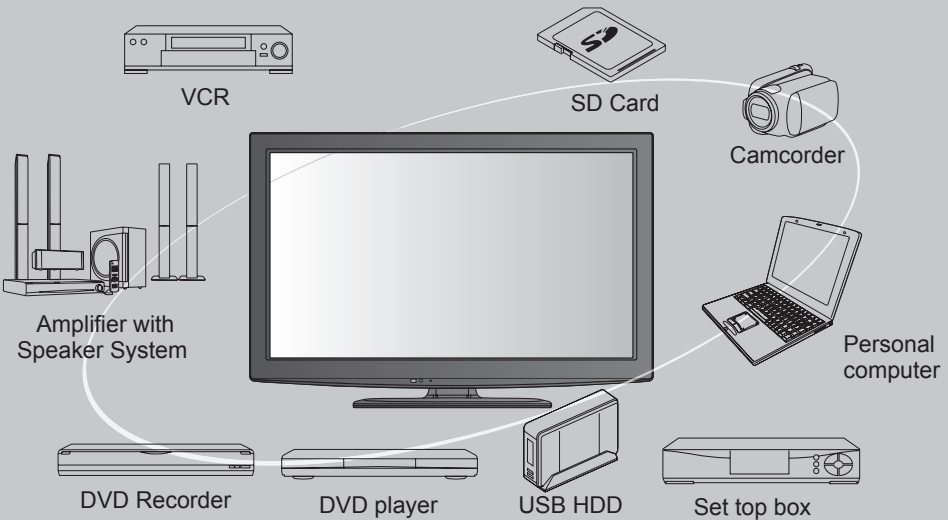

Notice about Digital TV Functions

- The MPEG-4 AVC feature was designed to specifications as we know them today. This specification may be subject to future changes beyond our control that may not guarantee the decoding of such services.

February 2010

The recording and playback of content on this or any other device may require permission from the owner of the copyright or other such rights in that content. Panasonic has no authority to and does not grant you that permission and explicitly disclaims any right, ability or intention to obtain such permission on your behalf. It is your responsibility to ensure that your use of this or any other device complies with applicable copyright legislation in your country. Please refer to that legislation for more information on the relevant laws and regulations involved or contact the owner of the rights in the content you wish to record or playback.

This product is licensed under the AVC patent portfolio license for the personal and non-commercial use of a consumer to (i) encode video in compliance with the AVC Standard ("AVC Video") and/or (ii) decode AVC Video that was encoded by a consumer engaged in a personal and non-commercial activity and/or was obtained from a video provider licensed to provide AVC Video. No license is granted or shall be implied for any other use. Additional information may be obtained from MPEG LA, LLC. See <http://www.mpegla.com>.

Standard accessories

Check that you have the accessories and items shown

- Remote Control
 - N2QAYB000496



- Pedestal → p. 6

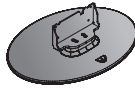

- Batteries for the Remote Control (2)
 - R6 (AA)



- Fall-prevention parts → p. 7

- Operating Instructions with Warranty statement

Caution

- This product contains possibly dangerous parts (such as plastic bags), which can be breathed in or swallowed by young children accidentally. Keep these parts out of reach of young children.

Inserting and removing remote's batteries

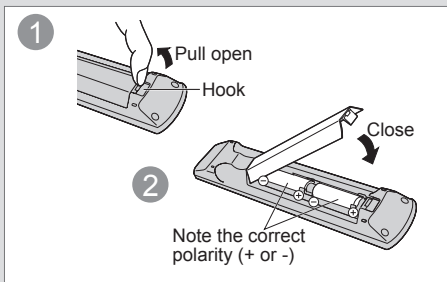

Caution

- Incorrect installation may cause battery leakage and corrosion, resulting in damage to the remote control.
- Do not mix old and new batteries.
- Do not mix different battery types (such as alkaline and manganese batteries).
- Do not use rechargeable (Ni-Cd) batteries.
- Do not burn or breakup batteries. Batteries must not be exposed to excessive heat such as sunshine, fire or the like.
- Do not disassemble or modify the remote control.

Contents

Be sure to Read

- Safety Precautions 4
(Warning / Important Installation Notices)

Quick Start Guide

- Accessories / Options 6
- Basic Connection 8
- Identifying Controls 10
- Auto Tuning 12

Quick Start Guide

Basic Features

- Watching TV 14
- Using TV Guide (Digital TV mode) 17
- Viewing Teletext 18
- Watching External inputs 20

Basic

Advanced Features

- How to Use VIERA TOOLS 22
- How to Use Menu Functions 23
- Tuning and Editing Channels 30
- Advanced Picture Settings 34
- Child Lock 36
- Input Labels 37
- Shipping Condition (Reset settings) 38
- Updating the TV Software (Digital TV mode) 39
- USB HDD Recording 40
- Using Media Player 44
- Using Network Services (DLNA / VIERA CAST) 52
- VIERA Link Functions 61
- VIERA Link "HDAVI Control"™ 64
- External Equipment 66

Advanced

Technical

- Technical Information 68
- Maintenance 74
- FAQs 75
- Licence 78
- Specifications 79
- WARRANTY 80

Technical

Safety Precautions

Warning

Handling the mains plug and lead

- Insert the mains plug fully into the socket outlet. (If the mains plug is loose, it could generate heat and cause fire.)
- Ensure that the mains plug is easily accessible.
- Do not touch the mains plug with a wet hand. (This may cause electrical shock.)
- Do not damage the mains lead. (A damaged lead may cause fire or electrical shock.)
 - Do not move the TV with the lead plugged in the socket outlet.
 - Do not place a heavy object on the lead or place the lead near a high-temperature object.
 - Do not twist the lead, bend it excessively, or stretch it.
 - Do not pull on the lead. Hold onto the mains plug body when disconnecting lead.
 - Do not use a damaged mains plug or socket outlet.

If you find any abnormality, remove the mains plug immediately!

AC 220 - 240 V
50 / 60 Hz



Power source / Installation

- This TV is designed for:
 - AC 220 - 240 V, 50 / 60 Hz
 - Indoor use
 - Table-top use

Do not remove covers and NEVER modify the TV yourself

- Do not remove the rear cover as live parts are accessible when it is removed. There are no user serviceable parts inside. (High-voltage components may cause serious electrical shock.)
- Have the TV checked, adjusted, or repaired at your local Panasonic dealer.

Do not expose to rain or excessive moisture

- To prevent damage which might result in electric shock or fire, do not expose this TV to rain or excessive moisture. This TV must not be exposed to dripping or splashing water and objects filled with liquid, such as vases, must not be placed on top of or above the TV.

Do not expose to direct sunlight and other sources of heat

- Avoid exposing the TV to direct sunlight and other sources of heat. To prevent fire never place any type of candle or naked flame on top or near the TV.

Do not insert foreign objects into the TV

- Do not allow any objects to drop into the TV through the air vents. (Fire or electrical shock may result.)

Do not place the TV on sloped or unstable surfaces

- The TV may fall off or tip over.

Use only the dedicated pedestals / mounting equipment

- Using an unapproved pedestal or other fixtures may make the TV unstable, risking injury. Be sure to ask your local Panasonic dealer to perform setup.
- Use approved pedestals (p. 6) / wall-hanging brackets (p. 7).

Do not allow children to handle SD Card

- As with any small object, SD Cards can be swallowed by young children. Please remove SD Card immediately after use and store out of reach of children.

Important Installation Notices

■ Install TV on a stable surface

If a television is not positioned in a sufficiently stable location, it can be potentially hazardous due to falling. Many injuries, particularly to children, can be avoided by taking simple precautions such as:

- Using cabinets or stands recommended by the manufacturer of the television.
- Only using furniture that can safely support the television.
- Ensuring the television is not overhanging the edge of the supporting furniture.
- Not placing the television on tall furniture (for example, cupboards or bookcases) without anchoring both the furniture and the television to a suitable support.
- Not standing the televisions on cloth or other materials placed between the television and supporting furniture.
- Educating children about the dangers of climbing on furniture to reach the television or its controls.

■ When cleaning the TV, remove the mains plug

- Cleaning an energized TV may cause electrical shock.

■ When the TV is not going to be used for a long period of time, remove the mains plug

- This TV will still consume some power even in the Off mode, as long as the mains plug is still connected to a live socket outlet.

■ Transport only in upright position

■ Allow sufficient space around the TV for radiated heat

- When using the pedestal, keep a space between the bottom of the TV and the surface where the TV is set.
- If using a wall-hanging bracket, refer to its manual.

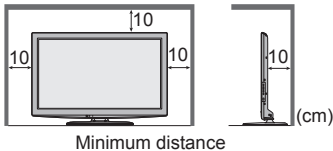

■ Do not block the rear air vents

- Blocked ventilation by newspapers, table cloths, curtains, etc. may cause overheating, fire or electrical shock.

■ Do not apply strong force or impact to the display panel.

- This may cause damage resulting in injury.

■ Do not expose your ears to excessive volume from the headphones

- Irreversible damage can be caused.

■ Auto power standby function

- If no signal is received and no operation is performed in Analogue TV mode for 30 minutes, the TV will automatically go to standby mode.

■ Keep the TV away from these types of equipment

- Electronic equipment
In particular, do not place video equipment near the TV. Electromagnetic interference may distort images / sound.
- Equipment with an infrared sensor
This TV also emits infrared rays. This may affect operation of other equipment.

Adjust the LCD panel to your desired angle

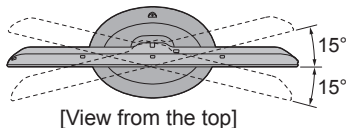
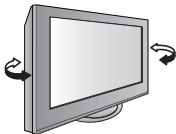

- Ensure that the pedestal does not hang over the edge of the base even if the TV swivels to the full rotation range.
- Do not place any objects or hands within the full rotation range.

Accessories / Options

Attaching the pedestal

Warning

Do not disassemble or modify the pedestal.

- Otherwise the TV may fall over and become damaged, and personal injury may result.

Caution

Do not use the pedestal for any other TV or displays.

- Otherwise the TV or the display may fall over and become damaged, and personal injury may result.

Do not use the pedestal if it becomes warped or physically damaged.

- If you use the pedestal while it is physically damaged, personal injury may result. Contact your nearest Panasonic dealer immediately.

During set-up, make sure that all screws are securely tightened.

- If insufficient care is taken to ensure screws are properly tightened during assembly, the pedestal will not be strong enough to support the TV, and it might fall over and become damaged, and personal injury may result.

Ensure that the TV does not fall over.

- If the TV is knocked or children climb onto the pedestal with the TV installed, the TV may fall over and personal injury may result.

Two or more people are required to install and remove the TV.

- If two or more people are not present, the TV may be dropped, and personal injury may result.

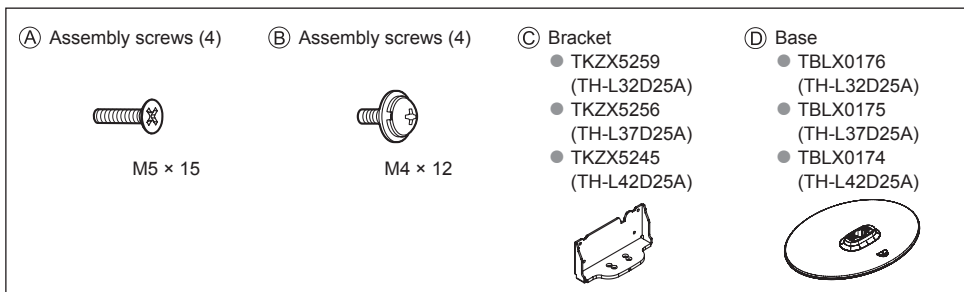

Assembling the pedestal

Use the assembly screws **(A)** to fasten the bracket **(C)** to the base **(D)** securely.

- Make sure that the screws are securely tightened.

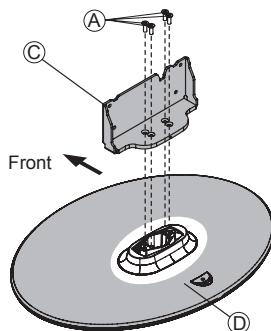

Securing the TV

Insert the bracket into the TV, and then fasten securely with the assembly screws **(B)**.

- Make sure that the screws are securely tightened.

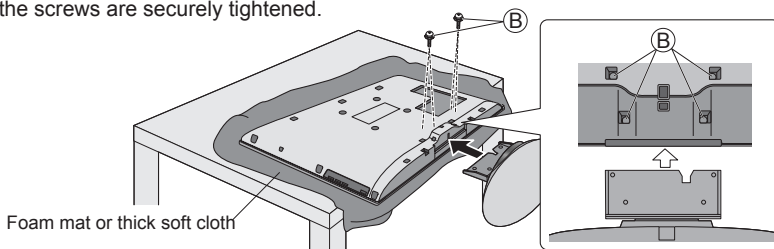

Preventing the TV from falling over

This TV could fall over if it is pushed, pulled or knocked down.

We therefore recommend the TV is secured to the furniture as illustrated.

- This measure is designed to reduce the risk of injury from a falling TV. However, it cannot guarantee protection in all cases.

Fall-prevention parts

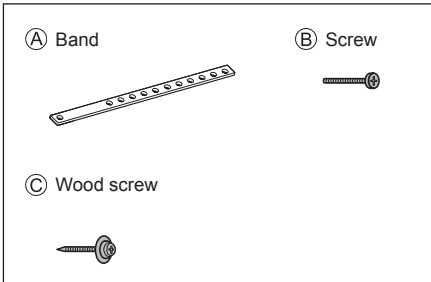

Securing to a furniture

Fix pedestal and furniture together with band.

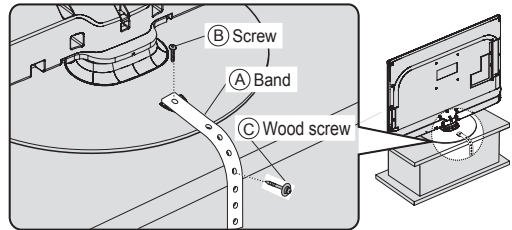

This image is for illustrative purposes only.

Optional accessories

Please contact your nearest Panasonic dealer to purchase the recommended optional accessories. For additional details, please refer to the manual of the optional accessories.

Wireless LAN Adaptor

- DY-WL10E-K



Caution

- To use the Wireless LAN Adaptor, your network needs to have a Wireless Access Point.
- It is recommended to use the Wireless LAN Adaptor with the extension cable.
- To avoid radio wave interface, keep the TV away from the devices such as other wireless LAN devices, microwaves and the devices that use 2.4 GHz and 5 GHz signals when using the Wireless LAN Adaptor. Otherwise malfunction may occur.
- This optional accessory may not be available in your market region.
- Additional information for Wireless LAN Adaptor and Wireless Access Point may be found at the following web site. (English only)
<http://panasonic.jp/support/global/cs/tv/>

Communication Camera

- TY-CC10W

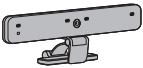

Caution

- This camera can be used on VIERA CAST (p. 60).
- Please also read the manual of the camera.
- Depending on the area, this optional accessory may not be available. For details, consult your local Panasonic dealer.

Wall-hanging bracket

- TY-WK3L2RW

The angle of wall-hanging bracket can be adjusted in "zero tilting (vertical)" and "5-degree tilting" for this TV.

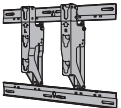

Rear of the TV

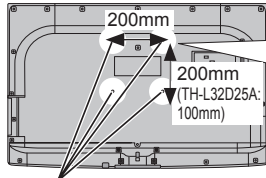

Holes for wall-hanging bracket installation

Screw for fixing the TV onto the wall-hanging bracket (not supplied with the TV)

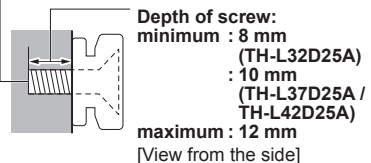

Warning

- Using other wall-hanging brackets, or installing a wall-hanging bracket by yourself have the risk of personal injury and product damage. In order to maintain the unit's performance and safety, be absolutely sure to ask your dealer or a licensed contractor to secure the wall-hanging brackets. Any damage caused by installing without a qualified installer will void your warranty.
- Do not mount the unit directly below ceiling lights (such as spotlights, floodlights or halogen lights) which typically give off high heat. Doing so may warp or damage plastic cabinet parts.
- Take care when fixing wall brackets to the wall. Always ensure that there are no electrical cables or pipes in the wall before hanging bracket.
- To prevent fall and injury, remove the TV from its fixed wall position when it is no longer in use.

Basic Connection

External equipment and cables shown are not supplied with this TV.
Please ensure that the TV is disconnected from the mains socket before attaching or disconnecting any leads.

Connecting aerial

TV only

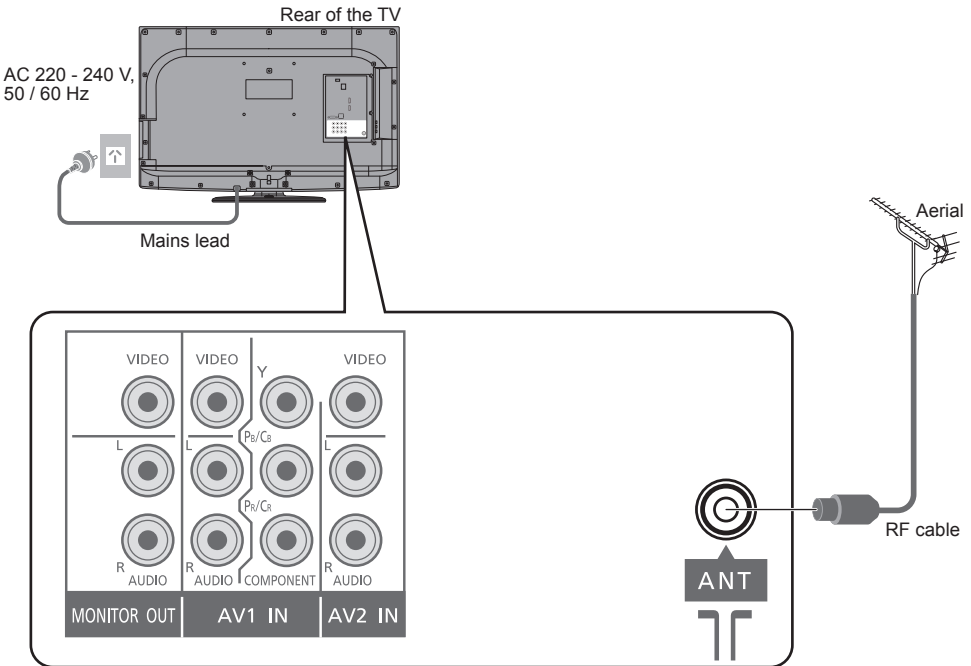

Note

- Do not put the RF cable close to the mains lead to avoid noise.
- Do not place the RF cable under the TV.
- To obtain optimum quality picture and sound, an aerial, the correct cable (75 Ω coaxial) and the correct terminating plug are required.
- If a communal aerial system is used, you may require the correct connection cable and plug between the wall aerial socket and the TV.
- Your local Television Service Centre or dealer may be able to assist you in obtaining the correct aerial system for your particular area and the accessories required.
- Any matters regarding aerial installation, upgrading of existing systems or accessories required, and the costs incurred, are the responsibility of you, the Customer.
- VIERA Link connection \rightarrow p. 61
- Read the manual of the equipment, too.
- Other equipment connection \rightarrow p. 66, 67, 76

Connecting DVD Recorder / VCR

TV, DVD Recorder or VCR

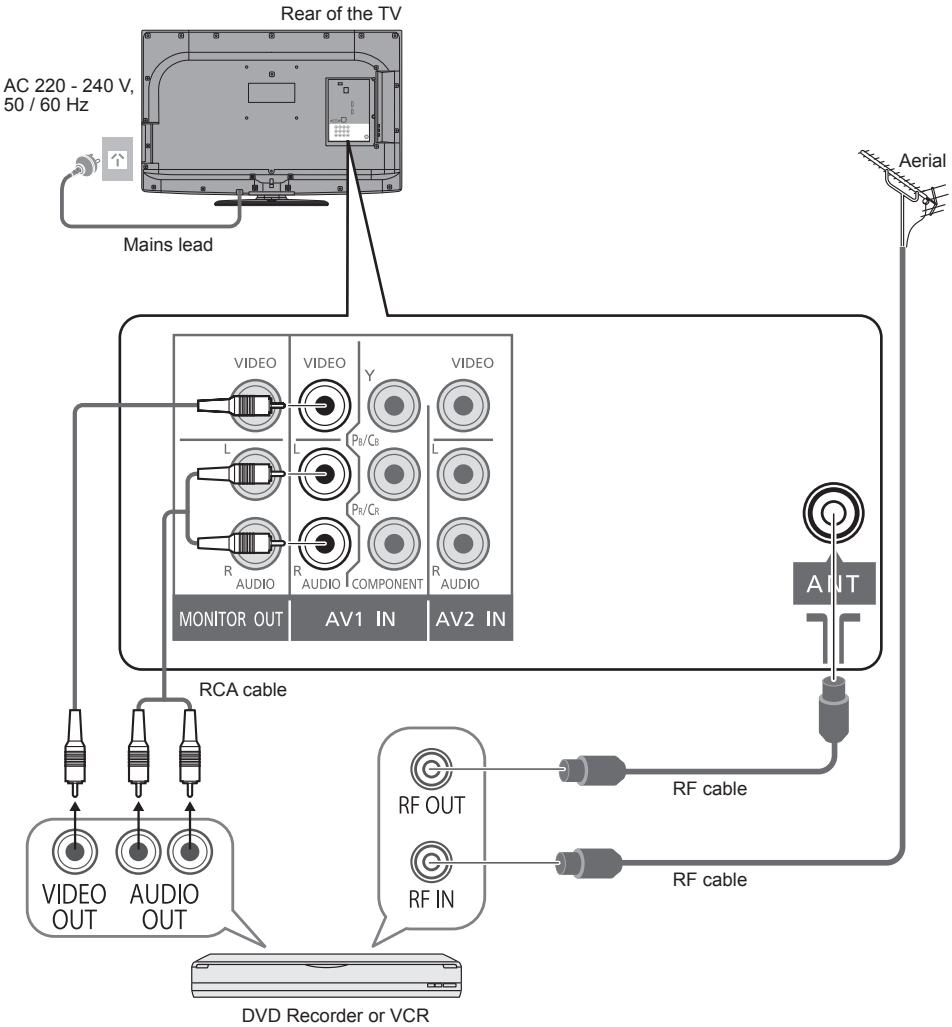

Identifying Controls

Remote control

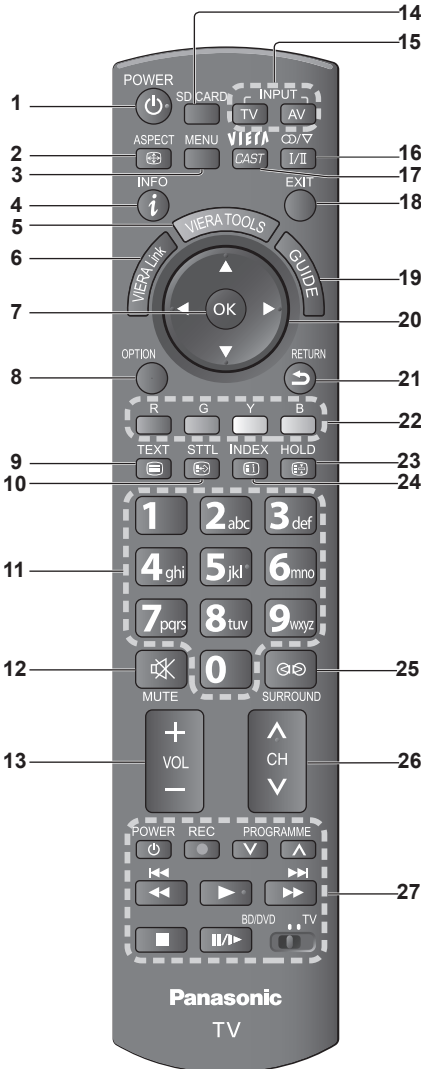

- 5 VIERA TOOLS (p. 22)**
 - Displays some special feature icons and accesses easily
- 6 VIERA Link (p. 61)**
 - Accesses VIERA Link Menu
- 7 OK**
 - Confirms selections and choices
 - Press after selecting channel positions to quickly change programme
- 8 Option Menu (p. 15)**
 - Easy setting for sound options
- 9 Teletext (p. 18)**
 - Switches to teletext mode
- 10 Subtitles (p. 14)**
 - Displays subtitles
- 11 Numeric buttons**
 - Changes channel and teletext pages
 - When in Standby mode, switches TV On
- 12 Sound Mute**
 - Switches sound mute On or Off
- 13 Volume Up / Down**
- 14 Media Player (p. 44)**
 - Switches to SD Card and USB device viewing / listening mode
- 15 Input mode selection**
 - TV - switches Digital TV / Analogue TV mode (p. 14)
 - AV - switches to AV input mode from Input Selection list (p. 20)
- 16 Stereo / Bilingual Sound Selection (p. 68)**
 - Changes the sound track when more than two choices are available (Digital TV mode) (p. 15)
- 17 VIERA CAST (p. 60)**
 - Displays VIERA CAST home screen
- 18 Exit**
 - Returns to the normal viewing screen
- 19 Guide (p. 17)**
 - Displays TV Guide
- 20 Cursor buttons**
 - Makes selections and adjustments
- 21 Return**
 - Returns to the previous menu / page
- 22 Coloured buttons**
 - Used for the selection, navigation and operation of various functions
- 23 Hold**
 - Freeze / unfreeze picture (p. 14)
 - Holds the current teletext page (teletext mode) (p. 18)
- 24 Index (p. 18)**
 - Returns to the teletext index page (teletext mode)
- 25 Surround (p. 26)**
 - Switches surround sound setting
- 26 Channel Up / Down**
 - Selects channel in sequence
- 27 Connected equipment operations (p. 21)**

TV

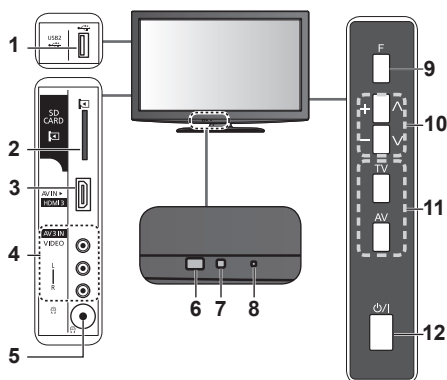

- 1 USB2 port
- 2 SD card slot
- 3 HDMI3 terminal
- 4 AV3 terminals
- 5 Headphone jack
- 6 Remote control signal receiver
 - Do not place any objects between the TV remote control signal receiver and remote control.

- 7 C.A.T.S. (Contrast Automatic Tracking System) sensor
 - Senses brightness to adjust picture quality when "Eco Mode" in the Picture Menu is set to "On" (p. 25)
- 8 Power LED
 - Standby: red On: green
 - When using the remote control, indicates the TV has received a command.
- 9 Function Select
 - Volume / Backlight / Contrast / Brightness / Colour / Sharpness / Tint (NTSC mode) / Bass ("Music" or "Speech" mode in the Sound Menu) / Treble ("Music" or "Speech" mode in the Sound Menu) / Balance / "Digital TV Auto Tuning" or "Analogue TV Auto Tuning" (p. 25 - 28)
- 10 Increases or decreases the channel position by one. When a function is already displayed, press to increase or decrease the selected function. When in standby mode, switches TV on.
- 11 Changes the input mode
- 12 Mains power On / Off switch
 - Switch On to turn on the TV or turn the TV to Standby mode by the remote control.

Using the On Screen Displays

Many features available on this TV can be accessed via the On Screen Display menu.

Example (Sound Menu):

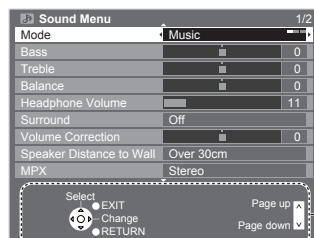

Operation guide will help you.

How to use remote control

MENU



Open the Main Menu



Move the cursor / select the menu item



Move the cursor / adjust levels / select from a range of options



Access the menu / store settings after adjustments have been made or options have been set

RETURN



Return to the previous menu

EXIT



Exit the menu system and return to the normal viewing screen

Auto Tuning

Search and store TV channels automatically.

- These steps are not necessary if the setup has been completed by your local dealer.
- Please complete connections (p. 8 and p. 9) and settings (if necessary) of the connected equipment before starting Auto Setup. For details of settings for the connected equipment, read the manual of the equipment.



1 Plug the TV into mains socket and switch On

- You can now use the remote control to turn On the TV or switch the TV to standby mode. (Power LED: On)

2 Select your area

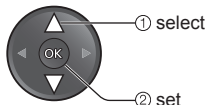
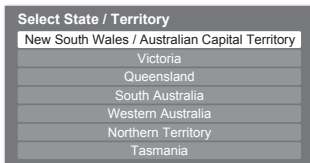

3 Select Auto Scan Type

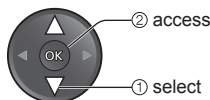
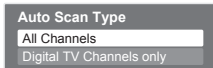

Auto Tuning starts

| CH | Channel Name | Type | Quality |
|----|-----------------|-------------|---------|
| 62 | CBBC Channel | Digital TV | 10 |
| 62 | BBC Radio Wales | Digital TV | 10 |
| 62 | E4 | Digital TV | 10 |
| 62 | Cartoon Nwk | Digital TV | 10 |
| 29 | | Analogue TV | - |
| 33 | | Analogue TV | - |

Digital TV: 4 Analogue TV: 2 Searching

- Auto Tuning will start to search for TV channels and store them. The sorted channel order depends upon the TV signal, the broadcasting system and reception conditions.

4 Setup the wireless LAN connection

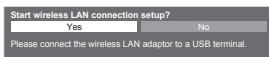

- For details → p. 13

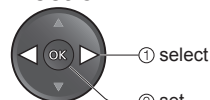

5 Select "Home"

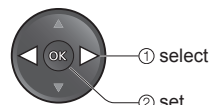

Auto Tuning is complete

*Viewing environment mode

Home : Recommended mode for viewing at home. Select "Home" for optimal picture / power consumption. "Viewing Mode" is set as "Normal" (p. 25).

Shop : Demonstration mode to explain main features of this TV (for in-store display). "Viewing Mode" is set as "Dynamic" (p. 25).

To return to viewing environment selection mode if you selected "Shop"

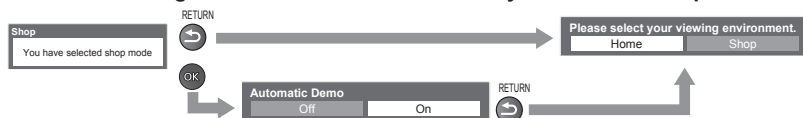

- To change viewing environment mode later on, reset all settings by accessing Shipping Condition. → "Shipping Condition" (p. 38)

Setup the wireless LAN connection

Setup the wireless LAN connection to enable the network service functions.

- To setup the wireless LAN connection, the wireless LAN Adaptor (optional accessory) is required. For the information about the Wireless LAN adaptor ➔ "Optional accessories" (p. 7)
- Confirm the encryption key, settings and positions of your access point before starting setup. For details, read the manual of the access point.
- Please note that this TV does not support wireless public access points.



① Connect the Wireless LAN Adaptor to the USB 1 or 2 port

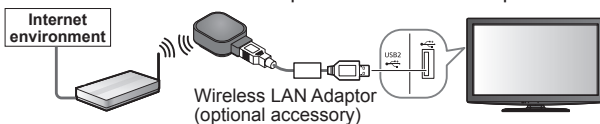

You can setup the wireless LAN connection later ➔ "Network Setup" (p. 54)

- To skip this step
EXIT
➔ or select "No"

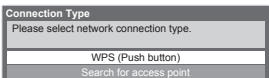

Select the connection type



- If your access point supports WPS (Push button), then select this option. If not, select "Search for access point".

WPS (Push button)

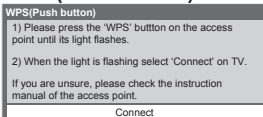

Press the WPS button on the access point until the light flashes. And then, press the OK button to connect the Wireless LAN Adaptor and the access point.

- Ensure that your access point supports WPS for this method.
- WPS: Wi-Fi Protected Setup™

Search for access point

| No. | SSID | Wireless type | Encrypt | Protection |
|-----|----------------|---------------|---------|------------|
| 01 | Access Point A | 11n (40MHz) | B | WPA2 |
| 02 | Access Point B | 11n (20MHz) | B | WPA2 |
| 03 | Access Point C | 11n (20MHz) | B | WPA2 |
| | | | | |
| | | | | |

Access points found automatically are listed. Select your desired access point.

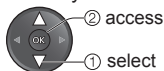

- To search access points again ➔
- For the information of the highlighted access point ➔ INFO

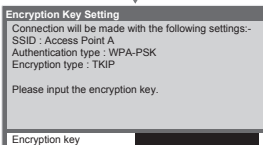

Access the encryption key input mode

- If the selected access point is not encrypted, the confirmation screen will be displayed. It is recommended to select the encrypted access point.



Enter the encryption key of the access point. Set characters one by one

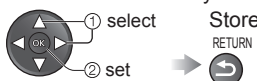

- You can set characters by using numeric buttons (p 23).

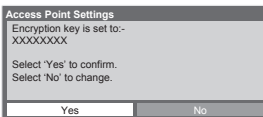

Select "Yes"

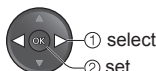

- To re-enter the encryption key, select "No".

Wireless LAN connection setup is completed

- If the connection is failed, check the encryption key, settings or positions of your access point. For details, read the manual of the access point.
- If connection to the access point is successful, we recommend you perform the "Connection Test" to confirm connection to the internet has been made. The "Connection Test" can be found in the Network Setup menu (p. 56).

Watching TV

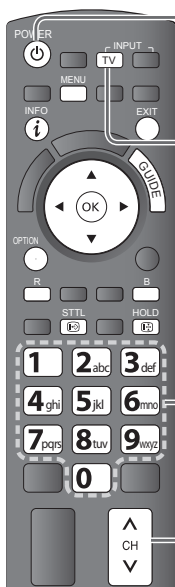

1 Turn power on

POWER



- Mains power On / Off switch should be On (p. 11).

2 Select Digital TV or Analogue TV mode



- Also possible to select the mode pressing the TV button repeatedly on the remote control or side panel of the TV. (p. 11).

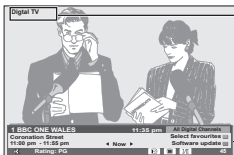

The selected mode is displayed.

Information banner appears whenever you select a channel

- For details → p. 15

3 Select a channel

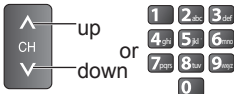

- To select the two or three-digit channel number, e.g. 39
 → 3.def → 9.mno (in a short time)
- If one or two-digit channel number
 → OK → quickly changes the channel

- To select from the Channel List → OK

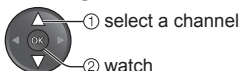

Note

- When the TV is switched to standby, there will be a clicking sound after a short delay. This is normal.

Select a channel using information banner (p. 15)

Possible to confirm the programme name before selecting channels.

Display information banner if it is not displayed



Possible to set display timeout in "Banner Display Timeout" (p. 28).

While the banner is displayed, select a channel

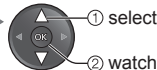

Select a channel using TV Guide (Digital TV mode) (p. 17)

Possible to confirm the TV Guide (EPG) before selecting channels.

Display TV Guide

Select a channel



Other useful functions

Hold



Freeze / unfreeze picture

Display subtitles



Display / hide subtitles (if available)

Off Timer

Turn the TV off automatically after a fixed period of time (Off / 15 / 30 / 45 / 60 / 75 / 90 minutes)

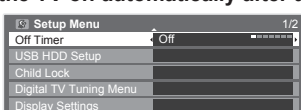

Select "Off Timer" and set the time

- To cancel → Set to "Off" or turn the TV off.
- To display the remaining time → Information banner
- When the remaining time is within 3 minutes, the remaining time will flash on screen.

Other useful functions

Display information banner



Display information banner

- Also appears when changing a channel

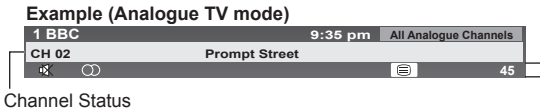
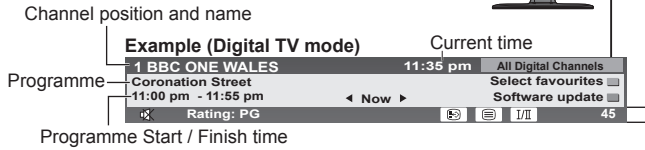

- To confirm another tuned channel name →
- To watch the programme listed in the banner →
- Information on the next programme (Digital TV mode) →
- To select a favourite list (Digital TV mode) →
- To update the TV software →
- To hide →
- Extra information (press again to hide the banner) (Digital TV mode) →
- To set display timeout → "Banner Display Timeout" (p. 28)

Features available / Message meanings

| | |
|-------------------|---|
| | Sound mute On |
| Rating | Rating information (p. 68) (Digital TV mode) |
| Bad signal | Poor TV signal quality (Digital TV mode) |
| Encrypted | Scrambled programme (Digital TV mode) |
| | Subtitle service available (Digital TV mode) |
| | Multiple image or audio available (Digital TV mode) |
| | Teletext service available |
| | Audio mode (p. 68) (Analogue TV mode) |
| | Off Timer remaining time |
| 1 - 90 | ● For settings → p. 14 |

Display the selectable settings for the current programme



Check or change the current programme status instantly

Audio Selection (Digital TV mode)
Allows you to select between alternative language for sound tracks (if available)

Dual Audio (Digital TV mode)
Selects multiplex sound (if available)

USB Remove Safely
Takes this operation to remove the connected USB device safely from the TV.

- To change

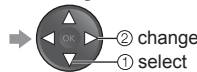

MPX (Analogue TV mode)
Selects multiplex sound (if available)
→ Sound Menu (p. 27)

Volume Correction
Adjusts volume of individual programme or input mode → Sound Menu (p. 26)

Watching TV

Other useful functions

Change aspect ratio

Enjoy viewing the picture at its optimum size and aspect.

ASPECT

 **Display Aspect Selection list**

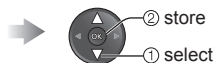
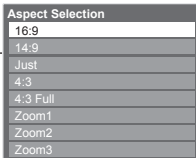

While the list is displayed, select the mode

To change the mode using the ASPECT button only

ASPECT

➔  Press repeatedly until you reach the desired mode

16:9



Directly displays the image at "16:9" without distortion (anamorphic).

14:9



Displays the image at the standard "14:9" without distortion.

Just



Displays a "4:3" image full-screen. Stretching is only noticeable at the left and right edges.

4:3



Displays the image at the standard "4:3" without distortion.

4:3 Full



Displays a "4:3" image enlarged horizontally to fit the screen.
● Digital TV mode and HD signal only

Zoom1



Displays a "16:9" letterbox or "4:3" image without distortion.

Zoom2



Displays a "16:9" letterbox (anamorphic) image full-screen without distortion.

Zoom3



Displays a "2.35:1" letterbox (anamorphic) image full-screen without distortion. At "16:9", displays the image at its maximum (with slight enlargement).

Note

- Only "16:9" and "4:3 Full" are available in Digital TV mode.
- Only "16:9" and "4:3" are available in PC input mode.
- Aspect is fixed to "16:9" when "Viewing Mode" is set to "Game" in the Picture Menu.
- Not available in teletext mode.
- Aspect mode can be memorized separately for each SD (Standard definition) and HD (High definition) signals except in Digital TV mode.

Region Select Adjust the standard time

Select the region where you live to adjust the standard time.

- The time contained in the broadcast signal is UTC (Universal Time coordinated) formally known as GMT (Greenwich Mean Time).

Daylight Saving Time Adjust for Summer Time

Select time offset from the standard time for Summer Time.

- Normally select "Auto".
- If there is a gap between displayed time and actual time, set this function.

| Region | Standard time | Daylight Saving Time: Auto (During Summer Time) |
|--------------------|---------------|---|
| NSW / ACT | +10:00 | +11:00 |
| Victoria | | |
| Queensland | +10:00 | |
| South Australia | +9:30 | +10:30 |
| Western Australia | +8:00 | |
| Northern Territory | +9:30 | |
| Tasmania | +10:00 | +11:00 |

(Based on GMT)

Using TV Guide (Digital TV mode)

Using TV Guide enables you to select a programme easily, view programme information, etc. TV Guide—Electronic Programme Guide (EPG) provides an on screen listing of the current and future programmes over the next seven days depending on broadcasters.

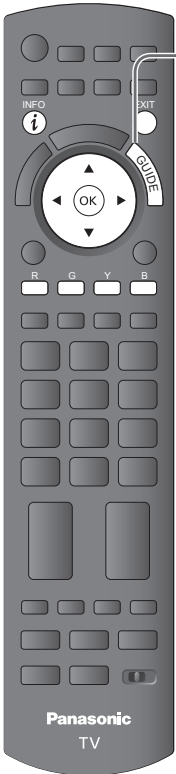

View TV Guide

Each time pressed, the layout will be changed. (Landscape / Portrait)

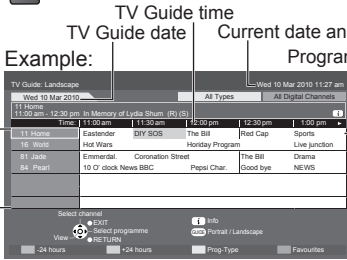

Landscape (Displays by channel)

Example:

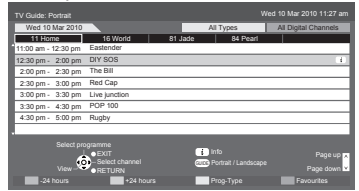

Portrait (Displays by time)

Channel position and name

To watch the programme

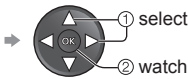

To view a channel list of the selected favourite list



(favourite list)

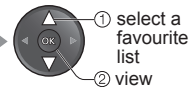
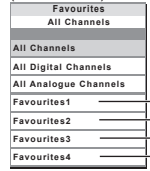

To list favourite channels ▶ p. 31

To return to TV



To view details of the programme



To the previous day



To the next day



To view a channel list of the selected type



(Type list)

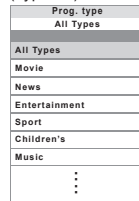

Note

- When this TV is turned on for the first time, or the TV is switched off for more than a week, it may take some time before the TV Guide is completely shown.

Viewing Teletext

Teletext services are the text information provided by the broadcasters. The features may vary depending on the broadcasters.

What is FASTEXT mode?

In FASTEXT mode, four differently coloured subjects are situated at the bottom of the screen. To access more information about one of these subjects, press the appropriately coloured button. This facility enables fast access to information on the subjects shown.

What is TOP mode? (In case of TOP text broadcasting)

TOP is a particular improvement of the standard teletext service that results in an easier search and effective guide.

- Fast overview of the teletext information available
- Easy to use step-by-step selection of the topical subject
- Page status information at the bottom of the screen

Available page up / down ➔ 

To select among subject blocks ➔ 

To select next subject within the subject block

(After the last subject, it moves to the next subject block.) ➔ 





What is List mode?

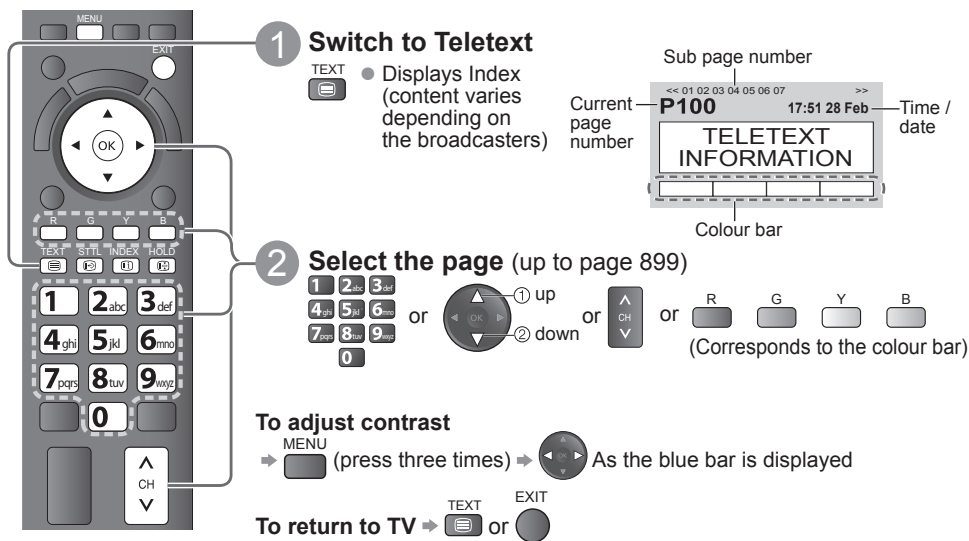

In List mode, four differently coloured page numbers are situated at the bottom of the screen. Each of these numbers can be altered and stored in the TV's memory. ("Store frequently viewed pages" ➔ p. 19)



To change mode ➔ "Teletext" in Setup Menu (p. 28)









1 Switch to Teletext
 ● Displays Index (content varies depending on the broadcasters)

2 Select the page (up to page 899)
 or  or  or 
 (Corresponds to the colour bar)

To adjust contrast
 ➔  (press three times) ➔  As the blue bar is displayed

To return to TV ➔  or 

Functions (Teletext mode)

| | |
|--|---|
| <p>Hold</p> <p> Stop automatic updating (If you wish to hold the current page without updating)</p> <p>To resume ➔ </p> | <p>Reveal hidden data</p> <p> ➔  Reveal hidden words e.g. quiz page answers</p> <p>To hide ➔ </p> |
| <p>INDEX</p> <p> Return to the main index page</p> | <p>Call up Subtitle</p> <p> Display subtitles</p> <ul style="list-style-type: none"> ● Call up P801 (subtitle page) if available. ● If you press this button during P801 is displayed, teletext mode will be cancelled and return to TV. |

Functions (Teletext mode)

View in multi window

Watch TV and Teletext in two windows at once

MENU (press twice) →  Select teletext only or picture / teletext



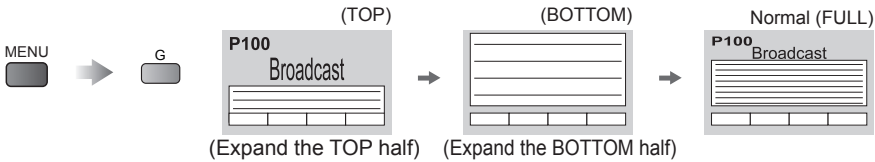

- Operations can be made only in Teletext screen.

FULL / TOP / BOTTOM



Store frequently viewed pages

Store frequently viewed pages in the colour bar (List mode only)

 →  press and hold

Corresponding colour button (As page is displayed)

P100 Broadcast

101 200 400 888

The number changes to white.

To change stored pages

→  →  press and hold



Colour button you want to change

1 2 3
4 5 6
7 8 9
0

Enter new page number

View sub page

View sub page (Only when teletext is more than one page)

<<01|02|03 04 05— Appears at top of the screen

To view specific sub page

→ MENU → B

T****

Broadcast

0 0 0 6 Enter the 4-digit number



→ T0006

- Sub pages:
The number of sub pages varies depending on the broadcasters.
It may take some time for searching, during which time you can watch TV.

Watch TV while waiting for update

View the TV picture while searching for a teletext page

Teletext automatically updates itself when new information becomes available.

MENU → Y →  →  → View the updated page

P108

Appears when updating is completed

Changes to TV screen temporarily (You cannot change the programme.)

- The news page provides a function that indicates arrival of latest news ("News Flash").

Watching External inputs

Connect the external equipment (VCRs, DVD equipment, PC, etc.) and you can watch through the input.

● To connect the equipment → p. 66, 67

The Remote Control is capable of operating some functions of selected external equipment. For details, see the manual of the equipment or ask your local dealer.



1 Display the input selection menu

AV

2 Select the input mode of the connected equipment

- You can also select the input using the AV button on the remote control or the side panel of the TV (p. 11). Press the button repeatedly until the desired input is selected.
- You can label or skip each input mode → “Input Labels” (p. 37). Skipped inputs will not be displayed when the AV button is pressed.

Example (AV2)

| Input Selection |
|-----------------|
| AV1 |
| AV2 |
| AV3 |
| PC |
| HDMI1 |
| HDMI2 |
| HDMI3 |
| TV |
| Media Server |

Example (PC)

| Input Selection |
|-----------------|
| AV1 |
| AV2 |
| AV3 |
| PC |
| HDMI1 |
| HDMI2 |
| HDMI3 |
| TV |
| Media Server |

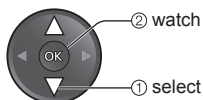

3 View

The selected mode is displayed on the screen.

Example (AV2)

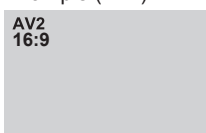

- If the external equipment has an aspect adjustment function, set to “16:9”.

Example (PC)

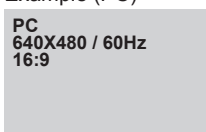









- You can also listen to PC sound with the audio cable connected. (To connect → p. 66 - 67)
- You can setup some functions, PC Setup in Setup Menu (p. 27).
- For HDMI-compatible PC, possible to connect to HDMI terminals (HDMI1 / HDMI2 / HDMI3) by using HDMI cable.

To return to TV



→ TV

Operating the equipment with the TV remote control

The equipment connected to the TV can be directly operated with the below buttons of this TV remote control.

| | |
|---|---|
|  | BD/DVD / TV switch* Switch to BD/DVD to operate Panasonic DVD Recorder, DVD Player, Player theatre, Blu-ray Disc theatre or VCR Switch to TV to operate USB HDD Recording, Media Player or VIERA Link equipment ➔ "USB HDD Recording" (p. 40) ➔ "Media Player" (p. 44) ➔ "VIERA Link Control" (p. 64) |
|  | Standby Set to Standby mode / Turn on |
|  | Play Playback videocassette / DVD |
|  | Stop Stop the operation |
|  | Rewind / Skip / Search VCR: Rewind, view the picture rapidly in reverse DVD / video content: Skip to the previous track or title (not available for the operation of USB HDD Recording) Press and hold to search backward |
|  | Fast-forward / Skip / Search VCR: Fast-forward, view the picture rapidly forward DVD / video content: Skip to the next track or title (not available for the operation of USB HDD Recording) Press and hold to search forward |
|  | Pause Pause / Resume DVD: Press and hold to play at slow speed |
|  | Programme Up / Down Select programme |
|  | Record Start recording |

*Setting your remote control to operate Panasonic VCR, DVD, etc.

- ① Switch to BD/DVD ➔ 
- ② Press and hold  during the following operations
- Enter the appropriate code
- See table below



| Type of equipment | Code |
|---------------------------------------|--------------|
| DVD Recorder / DVD Player | 70 (default) |
| Player theatre / Blu-ray Disc theatre | 71 |
| VCR | 72 |

Note

- Confirm if the remote control works correctly after changing the code.
- The codes may be reset to default values if batteries are replaced.
- Some operations may not be possible on some equipment models.

How to Use VIERA TOOLS

You can access some special features easily by using the VIERA TOOLS function.

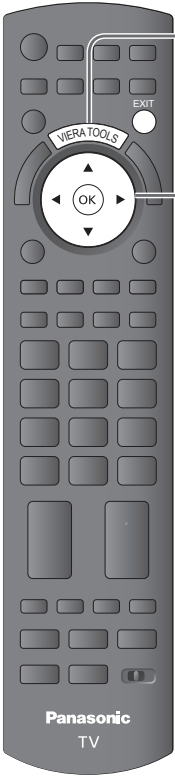

1 Display icons of the feature



2 Select a feature

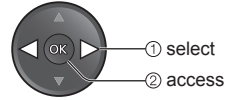

3 Follow the operation of each feature

- VIERA Link Control → "VIERA Link Control" (p. 64)



When two or more compatible equipment are connected, a selection screen will be displayed.
Please select the correct description and access.

- Pause Live TV → "Pause Live TV" (p. 63)



- Photo → "Photo mode" (p. 46)



When two or more available devices are connected, a selection screen will be displayed.
Please select the correct description and access.

- Video → "Video mode" (p. 48)



When two or more available devices are connected, a selection screen will be displayed.
Please select the correct description and access.

- Music → "Music mode" (p. 51)



When two or more available devices are connected, a selection screen will be displayed.
Please select the correct description and access.

- VIERA CAST → "VIERA CAST™" (p. 60)



- Media Server → "Using DLNA® features" (p. 57)



To return to TV



Note

- If the selected feature is not available, the demonstration to explain how to use it can be displayed. Press the OK button to view the demonstration after selecting the unavailable feature.

How to Use Menu Functions

Various menus allow you to make settings for the picture, sound, and other functions.



1 Display the menu



- Displays the functions that can be set (varies according to the input signal)

2 Select the menu

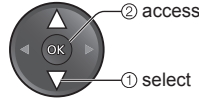

3 Select the item

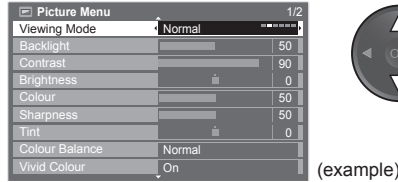

4 Adjust or select

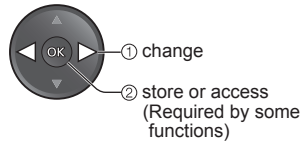
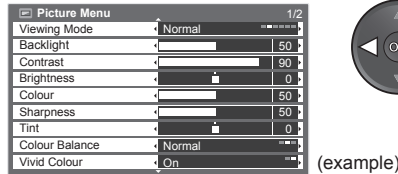

To return to TV at any time



To return to the previous screen



To change menu pages

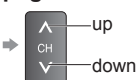

Choose from among alternatives

Number and positions of alternatives

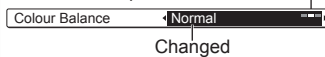

Changed

Adjust using the slide bar

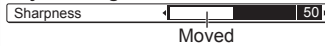

Moved

Go to the next screen



Displays the next screen

Enter characters by free input menu

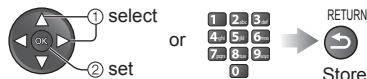

- To delete a character → R
- To delete all characters → B

Every press changes the character by one. Leave it for a second to set the character, or press OK or any numeric button within a second.

See the table below for the corresponding characters for each numeric button.

| Numeric buttons | Characters | Numeric buttons | Characters |
|-----------------|---------------------|-----------------|-------------------|
| 1 | . ! : # + - * _ () | 6 | m n o 6 M N O |
| 2 | a b c 2 A B C | 7 | p q r s 7 P Q R S |
| 3 | d e f 3 D E F | 8 | t u v 8 T U V |
| 4 | g h i 4 G H I | 9 | w x y z 9 W X Y Z |
| 5 | j k l 5 J K L | 0 | Space 0 |

VIERA Main Menu

Picture

Sound

Setup

Picture (p. 25, 26)

| | |
|------------------|--------|
| Picture Menu 1/2 | |
| Viewing Mode | Normal |
| Backlight | 50 |
| Contrast | 90 |
| Brightness | 0 |
| Colour | 50 |
| Sharpness | 50 |
| Tint | 0 |
| Colour Balance | Normal |
| Vivid Colour | On |

| | |
|------------------------|--------|
| Picture Menu 2/2 | |
| Reversal Film Effect | Off |
| Eco Mode | Off |
| P-NR | Off |
| 3D-COMB | On |
| Panel | On |
| Advanced Settings | Access |
| Reset Picture Defaults | Reset |

Sound (p. 26, 27)

| | |
|--------------------------|-----------|
| Sound Menu 1/2 | |
| Mode | Music |
| Bass | 0 |
| Treble | 0 |
| Equalizer | Access |
| Balance | 0 |
| Headphone Volume | 12 |
| Surround | Off |
| Volume Correction | 0 |
| Speaker Distance to Wall | Over 30cm |

| | |
|--------------------------|---------|
| Sound Menu 2/2 | |
| MPX | Stereo |
| Digital Audio Preference | Dolby D |
| SPDIF Selection | Auto |
| MPEG Optical Level | 0 dB |
| HDMI1 Input | Digital |
| Reset Sound Defaults | Reset |

Setup (p. 27 - 29)

| | |
|-------------------------|--------|
| Setup Menu 1/2 | |
| PC Setup | Access |
| DVI Position Settings | Access |
| Off Timer | Off |
| USB HDD Setup | Access |
| Child Lock | Access |
| Digital TV Tuning Menu | Access |
| Analogue TV Tuning Menu | Access |
| Display Settings | Access |
| VIERA Link Settings | Access |

| | |
|----------------|--------|
| Setup Menu 2/2 | |
| Network Setup | Access |
| DivX® VOD | Access |
| Advance(ifccc) | On |
| System Menu | Access |
| Other Settings | Access |

| | |
|-------------------------|--------|
| Digital TV Tuning Menu | |
| Favourites Edit | Access |
| Channel List | Access |
| Auto Tuning | Access |
| Manual Tuning | Access |
| Update Channel List | Access |
| New Channel Message | On |
| Signal Condition | Access |
| Add MPEG-4 AVC Channels | Access |

(p. 28)

| | |
|-------------------------|--------|
| Analogue TV Tuning Menu | |
| Channel List | Access |
| Auto Tuning | Access |
| Manual Tuning | Access |

(p. 28)

| | |
|------------------------|-----------|
| Display Settings | |
| Teletext | TOP |
| Input Labels | Access |
| Banner Display Timeout | 3 seconds |
| Playing Time Display | On |

(p. 28)

| | |
|--------------------------|-----|
| VIERA Link Settings | |
| VIERA Link | On |
| HDMI Content Type | Off |
| Power on Link | Off |
| Power off Link | On |
| Standby Power Save | Off |
| Intelligent Auto Standby | Off |

(p. 28)

| | |
|--------------------|--------|
| System Menu | |
| Shipping Condition | Access |
| System Update | Access |
| Software Licence | Access |
| System Information | Access |

(p. 29)



| | |
|----------------------|---------|
| Other Settings | |
| Motion Picture Pro | Off |
| 24p Smooth Film | Off |
| Resolution Enhancer | Off |
| Auto Standby | Off |
| Power Save | Off |
| 16:9 Overscan | On |
| Region Select | NSW/ACT |
| Daylight Saving Time | Auto |
| Video Preview | On |
| DVI Input Setting | Normal |

(p. 29)

Menu list

| Menu | Item | Adjustments / Configurations (alternatives) |
|---------|--|--|
| Picture | Viewing Mode | <p>Basic picture mode (Dynamic / Normal / Cinema / True Cinema / Game / Photo / Professional1 / Professional2)</p> <p>In each Viewing Mode, Backlight, Contrast, Brightness, Colour, Sharpness, Tint, Colour Balance, Vivid Colour, Eco Mode, P-NR and 3D-COMB can be adjusted and stored to suit your particular viewing requirement.</p> <ul style="list-style-type: none"> ● Set for each input signal. <p>Dynamic : Provides enhanced picture contrast and sharpness when viewing in a bright room</p> <p>Normal : Recommended for viewing under normal ambient room lighting conditions.</p> <p>Cinema : For watching movies in a darkened room with improving the performance of contrast, black and colour reproduction</p> <p>True Cinema : Precisely reproduces the original quality of the image without any revision.</p> <p>Game : Fast response signal specifically to provide suitable images for playing games</p> <ul style="list-style-type: none"> ● Not valid on TV mode ● A continuous record of time spent using Game mode can be displayed in the top right of the screen. <ul style="list-style-type: none"> ➔ "Playing Time Display" (p. 28) <p>Photo : Set "Reversal Film Effect" to "On" to provide the suitable image quality for photos</p> <ul style="list-style-type: none"> ● For HDMI input, Media Player and VIERA CAST <p>Professional: Allows you to set the professional picture settings in "Advanced Settings", "Lock Settings" and "Copy Adjustment" ➔ p. 34</p> <ul style="list-style-type: none"> ● This mode is available only when "Advance(isfcc)" in the Setup Menu is set to "On". ● Not valid on VIERA CAST ● If the certified professional dealer sets these modes, "Professional1" and "Professional2" may be displayed as "isf Day" and "isf Night". |
| | Backlight, Contrast, Brightness, Colour, Sharpness | Increases or decreases the levels of these options according to your personal preference |
| | Tint | <p>With an NTSC signal source connected to the TV, the picture hue can be adjusted to suit your taste.</p> <ul style="list-style-type: none"> ● For NTSC or Component / HDMI input signal reception only ● Not valid when "Viewing Mode" for HDMI input is set to "Photo" |
| | Colour Balance | <p>Allows you to set the overall colour tone of the picture (Cool / Normal / Warm)</p> <ul style="list-style-type: none"> ● Not valid when "Viewing Mode" is set to "True Cinema", "Professional1" or "Professional2" |
| | Vivid Colour | <p>Automatically adjusts colours to vivid ones (Off / On)</p> <ul style="list-style-type: none"> ● Not valid on PC signal ● Not valid when "Viewing Mode" is set to "Professional1" or "Professional2" |
| | Reversal Film Effect | <p>Provides the picture effect such as the reversal film (Off / On)</p> <ul style="list-style-type: none"> ● This function is available when "Viewing Mode" is set to "Photo". |
| | Eco Mode | <p>Automatically adjusts the screen brightness appropriately as the surrounding light level lowers to reduce the power consumption (Off / On)</p> <ul style="list-style-type: none"> ● Not available in shop mode (Dynamic picture mode) |

| Menu | Item | Adjustments / Configurations (alternatives) |
|---------|--------------------------|--|
| Picture | P-NR | Picture Noise Reduction Automatically reduces unwanted picture noise and flicker noise in the contoured parts of a picture (Off / Min / Mid / Max) <ul style="list-style-type: none"> ● Not valid on PC signal ● Not valid when “Viewing Mode” is set to “Professional1” or “Professional2” |
| | 3D-COMB | Makes still or slow moving pictures look more vivid (Off / On) <ul style="list-style-type: none"> ● Occasionally, while viewing still or slow moving pictures, colour patterning may be seen. Set to “On” to display sharper and more accurate colours. ● For PAL or NTSC signal reception only ● Not valid on Component, PC, HDMI and Media Player |
| | Panel | Turns the screen off when you select “Off” (Off / On) <ul style="list-style-type: none"> ● The sound is active even if the screen turns off. ● Press any buttons to turn the screen on. ● This function is effective in reducing power consumption when listening to a sound without watching the TV screen. |
| | Advanced Settings | Sets the detailed picture settings (p. 34) |
| | Reset Picture Defaults | Press the OK button to reset the present Picture Menu settings to the default. |
| Sound | Mode | Selects basic sound mode (Music / Speech / User) <ul style="list-style-type: none"> ● The selected mode affects all input signals. Music : Improves sound quality for watching music video, etc. Speech : Improves sound quality for watching news, drama, etc. <ul style="list-style-type: none"> ● In Music and Speech mode, you can adjust “Bass” and “Treble” settings, and those settings will be stored for each mode. User : Adjusts the sounds manually by using the equalizer to suit your favourite sound quality. <ul style="list-style-type: none"> ● For the User mode, “Equalizer” will appear on the Sound Menu instead of “Bass” and “Treble”. Select the “Equalizer” and adjust the frequency. ➔ “Equalizer” (below) |
| | Bass | Increases or decreases level to enhance or minimise lower, deeper sound output |
| | Treble | Increases or decreases level to enhance or minimise sharper, higher sound output |
| | Equalizer | Adjusts the frequency level to suit your favourite sound quality <ul style="list-style-type: none"> ● This function is available when “Mode” is set to “User”. ● Select the frequency and change the frequency level by using the cursor button. ● If you want to enhance the bass sound, raise the level of the lower frequency. If you want to enhance the treble sound, raise the level of the higher frequency. ● To reset the levels of each frequency to the default settings, select the “Reset Sound Defaults” by using cursor button, and then press the OK button. |
| | Balance | Adjusts the volume level of right and left speakers |
| | Headphone Volume | Adjusts the volume of the headphones |
| | Surround | Surround sound settings (Off / V-Audio / V-Audio Surround / V-Audio ProSurround) <ul style="list-style-type: none"> V-Audio : Provides a dynamic enhancer of width to simulate improved spatial effects V-Audio Surround : Provides a dynamic enhancer of width and depth to simulate improved spatial effects V-Audio ProSurround : Provides a three-dimensional sound space with digital reverb effects ● Switching is also possible by the Surround button on the remote control (p. 10). |
| | Volume Correction | Adjusts the volume of individual channel or input mode |
| | Speaker Distance to Wall | Adjusts the low frequency sound (Over 30cm / Up to 30cm) <ul style="list-style-type: none"> ● If the back space between the TV and wall is over 30 cm, “Over 30cm” is recommended. ● If the back space between the TV and wall is within 30 cm, “Up to 30cm” is recommended. |

| Menu | Item | Adjustments / Configurations (alternatives) | |
|----------------------|--|---|---|
| Sound | MPX | Selects multiplex sound mode (if available) (p. 68) <ul style="list-style-type: none"> ● Normally : Stereo ● Stereo signal cannot be received: Mono ● M1 / M2 : Available while mono signal is transmitted ● Analogue TV mode only | |
| | Digital Audio Preference | Selects the initial setting for Audio tracks (Dolby D / MPEG) If programme has both Dolby Digital and MPEG audio tracks, priority is given to what you select Dolby D : A method of coding digital signals developed by Dolby Laboratories. Apart from stereo (2ch) audio, these signals can also be multi-channel audio. MPEG : An audio compression method that compresses audio to small size without any considerable loss of audio quality. <ul style="list-style-type: none"> ● Digital TV mode only | |
| | SPDIF Selection | SPDIF : A standard audio transfer file format Selects the initial setting for digital audio output signal from DIGITAL AUDIO OUT terminal (Auto / PCM) Auto : Dolby Digital is output as Dolby Digital Bitstream. HE-AAC and MPEG are output as PCM. PCM : Digital output signal is fixed to PCM. <ul style="list-style-type: none"> ● For Digital TV mode or Video mode (p. 48) | |
| | MPEG Optical Level | Adjusts the audio level of MPEG output from DIGITAL AUDIO OUT terminal as the initial setting (0 / -2 / -4 / -6 / -8 / -10 / -12dB) <ul style="list-style-type: none"> ● Normally, MPEG sound is louder comparing with the other types of audio track. ● Digital TV mode only | |
| | HDMI1 / 2 / 3 Input | Select to fit the input signal (Digital / Analogue) (p. 69). Digital : HDMI cable connection Analogue : HDMI-DVI adaptor cable connection <ul style="list-style-type: none"> ● HDMI input mode only | |
| | Reset Sound Defaults | Press the OK button to reset the present settings of Mode, Balance, Headphone Volume, and Surround in Sound Menu to the default. | |
| | Setup | PC Setup | Input Resolution |
| Clock | | | Set to the minimum level if noise occurs. |
| H-pos | | | Adjusts horizontal position  |
| V-pos | | | Adjusts vertical position  |
| Clock Phase | | | Eliminates flicker and distortion <ul style="list-style-type: none"> ● Adjust after Clock adjustment ● Set to the minimum level if noise occurs |
| Sync | | | PC sync signal type (H & V / SOG) H & V : by the horizontal and vertical signals from your PC SOG : Sync on Green sync from your PC |
| Reset PC Settings | | | Press the OK button to reset the present PC Setup settings to the default. |
| DVI Position Setting | | H-pos | Adjusts horizontal position settings of DVI |
| | V-pos | Adjusts vertical position settings of DVI | |
| | Reset DVI Position Settings | Press the OK button to reset the present DVI Position settings to the default. | |
| Off Timer | Sets the time the TV automatically goes to Standby mode (Off / 15 / 30 / 45 / 60 / 75 / 90 minutes) | | |

| Menu | Item | Adjustments / Configurations (alternatives) | |
|-------|----------------------------|--|--|
| Setup | USB HDD Setup | Registers the connected USB HDD and makes the settings for the recording (p. 40) | |
| | Child Lock | Locks a channel / AV input to prevent access to it (p. 36) | |
| | Tuning Menu | Favourites Edit | Creates list of favourite channels (Digital TV mode) (p. 31) |
| | | Channel List | Skips the unwanted channels or edits channels (p. 31, 33) |
| | | Auto Tuning | Sets all Digital TV or Analogue TV channels automatically (p. 32, 33) |
| | | Manual Tuning | Sets the TV channels manually (p. 32, 33) |
| | | Update Channel List | Updates the channel list with keeping your settings (Digital TV mode) (p. 32) |
| | | New Channel Message | Selects whether to give a notification message when a new channel is found (Digital TV mode) (Off / On) (p. 32) |
| | | Signal Condition | Checks the Digital TV signal condition (p. 32) |
| | | Add MPEG-4 AVC Channels | Activates the reception of MPEG-2 and MPEG-4 AVC Channels <ul style="list-style-type: none"> ● Use this function if MPEG-4 AVC services start in your area. ● All previous tuning setting are erased. ● Once activated, this option is removed from the Digital TV Tuning Menu. |
| | Display Settings | Teletext | Teletext display mode (TOP(FASTEXT) / List) (p. 18) |
| | | Input Labels | Labels or skips each input terminal (p. 37) |
| | | Banner Display Timeout | Sets how long the information banner stays on screen (p. 15) (0 (No display) / 1 / 2 / 3 / 4 / 5 / 6 / 7 / 8 / 9 / 10 seconds) |
| | | Playing Time Display | Set to "On" to display a continuous record of time spent using Game mode every 30 mins (Off / On) <ul style="list-style-type: none"> ● This function is available when "Game" is selected in "Viewing Mode" (p. 25). |
| | VIERA Link Settings | VIERA Link | Sets to use VIERA Link functions (Off / On) <ul style="list-style-type: none"> ● VIERA Link functions become available when "VIERA Link" is set to "On" (p. 61). |
| | | HDMI Content Type | Adjusts the picture settings according to the content type from the connected equipment via HDMI cable (Off / Auto) <ul style="list-style-type: none"> ● This function is available if the connected equipment supports HDMI Content Type. ● The content type information will be displayed for several seconds when this function works. |
| | | Power on Link | Sets to use Power on Link functions (Off / On) (p. 62) |
| | | Power off Link | Sets to use Power off Link functions (Off / On) (p. 62) |
| | | Standby Power Save | Controls the power consumption in Standby mode of the connected equipment to reduce the power consumption (Off / On) (p. 62) <ul style="list-style-type: none"> ● This function is available when "VIERA Link" is set to "On" and "Power off Link" is set to "On". |
| | | Intelligent Auto Standby | Makes non-watched or non-used connected equipment go into Standby mode to reduce the power consumption (Off / On (With reminder) / On (No reminder)) (p. 62) <ul style="list-style-type: none"> ● This function is available when "VIERA Link" is set to "On". |
| | Network Setup | Sets the network setting to use in your network environment (p. 54) | |
| | DivX® VOD | Displays DivX VOD registration code (p. 72) | |
| | Advance(isfcc) | Enables the advanced picture settings (Off / On) <ul style="list-style-type: none"> ● Set to "On" to enable the mode of "Professional1" and "Professional2" in "Viewing Mode". ● Set to "On" to display the advanced items in the Picture Menu - "Advanced Settings", "Lock Settings" and "Copy Adjustment". "Copy Adjustment" will be displayed when "Viewing Mode" is set to "Professional1" or "Professional2". ● "isfcc" is the picture setting for the certified professional dealer. For details, consult your local dealer. | |



| Menu | Item | Adjustments / Configurations (alternatives) | |
|-------|----------------|---|--|
| Setup | System Menu | Shipping Condition | Resets all settings to the original condition (p. 38) |
| | | System Update | Downloads new software to TV (p. 39) |
| | | Software Licence | Displays the software licence information |
| | | System Information | Displays the system information of this TV |
| | Other Settings | Motion Picture Pro | Automatically compensates the picture frame rate and removes juddering movements to make the images smooth and clear (Off / Mid / Max) <ul style="list-style-type: none"> This function is not available for selection (default to "Off") when "Viewing Mode" is set to "Game" or in the mode of PC input, photo or Network service operations. |
| | | 24p Smooth Film | Automatically compensates the picture frame rate to make the 24p source movie images smooth (Off / Mid / Max) <ul style="list-style-type: none"> This is available only for 24p signal input and displayed instead of "Motion Picture Pro". This function is not available for selection (default to "Off") when "Viewing Mode" is set to "Game" or in the mode of PC input, photo or Network service operations. |
| | | Resolution Enhancer | Enhances the picture resolution to make the image sharper (Off / Mid / Max) <ul style="list-style-type: none"> This function is available for SD (Standard definition) signal. As for HD (High definition) signal, this function is available when aspect mode is set to 16:9 (16:9 Overscan is set to "On"), 4:3 Full or Zoom. Not valid on PC, VIERA CAST and Media Player |
| | | Auto Standby | Sets the time the TV automatically goes to Standby mode when no operation is performed for the selected times (Off / 2 hours / 4 hours) <ul style="list-style-type: none"> Inserting the SD Card to the card slot does not affect this function. Automatic input switching with the connected equipment affects this function and time-count will be reset. The notification message will appear 3 minutes before going to Standby mode. |
| | | Power Save | Reduces brightness of picture to economise on power consumption (Off / On) |
| | | 16:9 Overscan | Selects the screen area for displaying the image (Off / On) <p>On: Enlarges the image to hide the edge of the image Off: Displays the image in the original size</p> <ul style="list-style-type: none"> Set to "On" if noise is generated on the edges of the screen. This function is available when aspect is set to "16:9". This function can be memorized separately for SD (Standard Definition) and HD (High Definition) signals. |
| | | Region Select | Selects the region where you live to adjust the standard time (NSW / ACT / Victoria / Queensland / South Australia / Western Australia / Northern Territory / Tasmania) (p. 16) |
| | | Daylight Saving Time | Select time offset from the standard time for Summer Time (Auto / Off / +1/2 hour / +1 hour) (p. 16) <ul style="list-style-type: none"> Set to "Auto" normally. |
| | | Video Preview | Selects the displaying of the preview window when a video file is selected (Off / On) |
| | | DVI Input Setting | Changes the black level in the image for HDMI input mode with DVI input signal manually (Normal / Full) <ul style="list-style-type: none"> When the DVI input signal from the external equipment, especially from PC, is displayed, the black level may not be suitable. In this case, select "Full". The black level for HDMI input signal will be adjusted automatically. |

- A different menu will be displayed when "Advance(isfcc)" in the Setup Menu is set to "On" or in the mode of Media Player or Network service operations. (p. 34 and p. 44 - 60)
- Only available items can be selected.

Tuning and Editing Channels

You can make Auto Tuning, listing your favourite channels, skipping unwanted channels, etc.

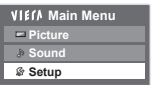
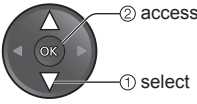

- 1 Select Digital TV or Analogue TV**

 - The selected mode is displayed on the screen (p. 14).
- 2 Display the menu**

- 3 Select "Setup"**

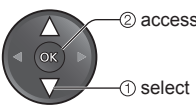

4 Select "Digital TV Tuning Menu" or "Analogue TV Tuning Menu"

| Digital TV Tuning Menu | | Analogue TV Tuning Menu | |
|------------------------|--------|-------------------------|--------|
| Setup Menu | 1/2 | Setup Menu | 1/2 |
| Off Timer | Off | Off Timer | Off |
| USB HDD Setup | | USB HDD Setup | |
| Child Lock | | Child Lock | |
| Digital TV Tuning Menu | Access | Analogue TV Tuning Menu | Access |
| Display Settings | | Display Settings | |
| VIERA Link Settings | | VIERA Link Settings | |



To return to TV



For Auto Tuning, using the buttons on the side panel of the TV (p. 11)

① Press repeatedly until "Auto Tuning" appears



② Access "Auto Tuning"



③ Start "Auto Tuning"



To return to TV



5 Select a function

| Digital TV Tuning Menu | | Analogue TV Tuning Menu | |
|------------------------|--------|-------------------------|--------|
| Digital TV Tuning Menu | | Analogue TV Tuning Menu | |
| Favourites Edit | Access | Channel List | Access |
| Channel List | Access | Auto Tuning | Access |
| Auto Tuning | Access | Manual Tuning | Access |
| Manual Tuning | Access | | |
| Update Channel List | Access | | |
| New Channel Message | On | | |
| Signal Condition | Access | | |

● For details → p. 31, 32

● For details → p. 33

6 Set (see next page)

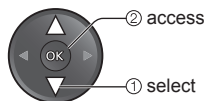

Digital TV Tuning Menu

Favourites Edit List favourite channels

Create your favourite channel lists (Favourites) from various broadcasters (up to 4: Favourites1 to 4). The Favourites lists are available from the Information banner (p. 15) and the TV Guide (p. 17).

① Select a channel to list

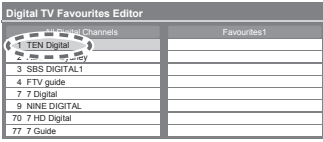

To display another Favourites
 → **G**

② Add it to the Favourites list

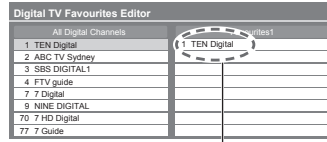

To add all channels to the list → **Y**

A channel is added

To edit List



Select the field of Favourites to edit and:

To name the Favourites → **R**



(maximum: ten characters)

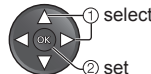

Set characters

You can set characters by using numeric buttons (p. 23).

RETURN

Store

To move the channel → **G** → Select the new position → **G** → **Confirm**

To delete the channel → **OK**

To delete all channels → **Y**

③ Store



Note

- Channel numbers are defined by the broadcaster and cannot be changed.
- Hidden channels (see below) can be selected but not viewed.

Channel List Skip unwanted channels / Edit channels

Select a channel and reveal / hide

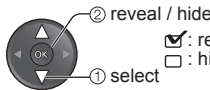
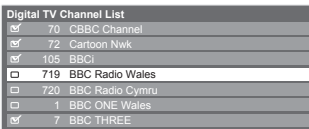

: reveal
: hide (skip)

You can hide unwanted channels. The hidden channels cannot be displayed except in this function. Use this function to skip unwanted channels.

To reveal all channels → **Y**

To retune each channel (Manual Tuning) (p. 32) → **R**

To edit channels

You can also edit each channel in Channel List.

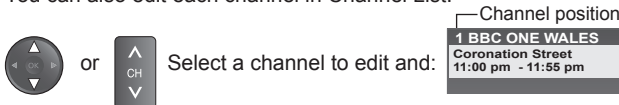

To swap the channel position (if available) → **G** → Enter the new position number → **G** → **Store**

To move the channel position (if available) → **G** → Select the new position → **G** → **Store**

Digital TV Tuning Menu

Auto Tuning Set all channels automatically

Start Auto Tuning

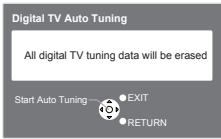

Settings are made automatically

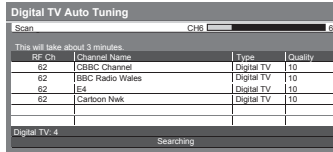

Automatically retune all Digital TV channels received in the area.

- All the previous tuning settings are erased.
- When the operation is completed, the channel at channel position “1” will be displayed.
- Search begins in the order from the lower channels to the higher channels. Channels received during this process are added to the list (p. 31).
- If tuning has not been done completely ⇒ “Manual Tuning” (see below)

Manual Tuning Set Digital TV channel manually

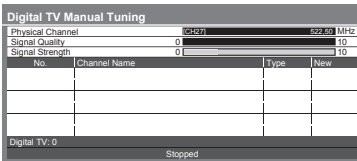

Normally use “Auto Tuning” or “Update Channel List” to update Digital TV channels on your channel list. If tuning has not been done completely or for adjusting the direction of the aerial, use this function.



- ① select physical channel
- ② adjust frequency (set where the level of “Signal Quality” becomes the maximum)
- ③ search

- All channels found will be added to the Digital TV Channel List.

Update Channel List Update channels automatically

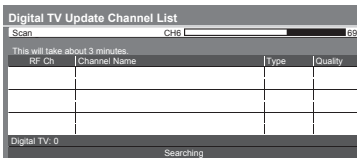

You can add new channels, delete duplicated channels, update channel name and position automatically to Channel List.

- Channel List is updated with keeping your settings in Favourites Edit, Channel List, Child Lock, etc.

New Channel Message Display a notification message

New channels found!
Press OK to update channel list.
Press EXIT to ignore.

Selects whether to give a message when new Digital TV channel is found. (**Off / On**)

- Selecting OK will perform “Update Channel List”.

Signal Condition Check Digital TV signal

- To change the channel ⇒

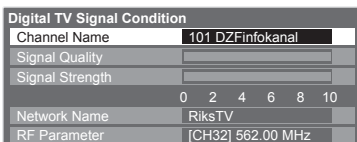

Selects a channel and checks the Digital TV signal condition.

A good Signal Strength is not an indication of suitable signal for Digital TV reception. Please use the Signal Quality indicator as follows:

Signal Quality:

- Green bar ⇒ Good
- Yellow bar ⇒ Poor
- Red bar ⇒ Bad (Check the aerial)

Analogue TV Tuning Menu

Channel List Skip unwanted channels / Edit channels (Change name, Move)

Select a channel and reveal / hide

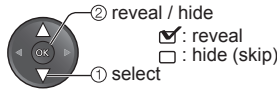
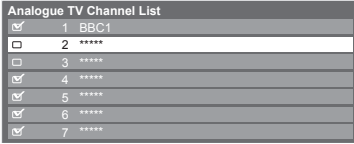

You can hide unwanted channels. The hidden channels cannot be displayed except in this function. Use this function to skip unwanted channels.

To reveal all channels →

To edit channels

You can also edit each channel in Channel List.

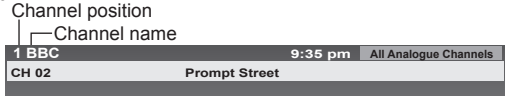
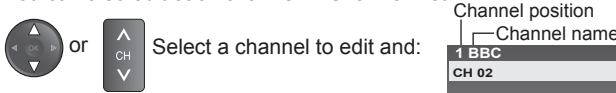

- To move the channel position → → Select the new position → Store
- To rename the channel name →



(maximum: five characters)

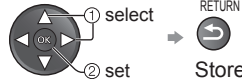

Set characters

- You can set characters by using numeric buttons (p. 23).

Note

- If a VCR is connected only with the RF cable, edit "VCR".

Auto Tuning Set all Analogue TV channels automatically

Start Auto Tuning

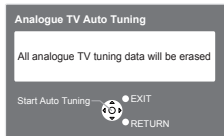

Settings are made automatically

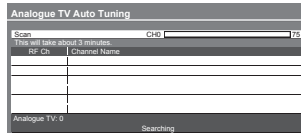

Automatically retune all Analogue TV channels received in the area.

- All the previous tuning settings are erased.
- When the operation is completed, the channel at channel position "1" will be displayed.
- Search begins in the order from the lower channels to the higher channels. Channels received during this process are added to the list (see above).
- If tuning has not been done completely → "Manual Tuning" (see below)

Manual Tuning Set Analogue TV channel manually

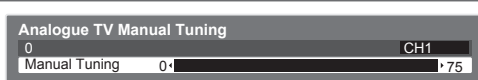

Set Analogue TV channel manually after Auto Tuning.

- If a VCR is connected only with the RF cable, select channel position "0".

Select a channel position



Select a channel



Search and store

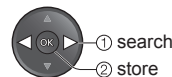

Advanced Picture Settings

You can adjust and setup the detailed picture settings for each input and Viewing Mode.

- To use this function completely, set "Advance(isfcc)" to "On" in the Setup Menu. ➔ p. 28
- For PC input mode, some functions are available without setting "Advance(isfcc)".



1 Select the input mode to adjust and setup
➔ p. 20



2 Display the menu



3 Select "Picture"

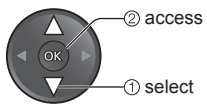
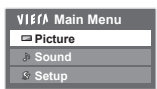

4 Select "Viewing Mode" and set the mode

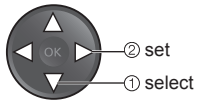
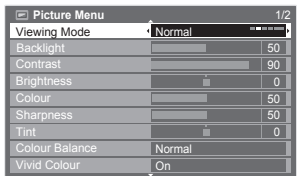

5 Select one of the following functions

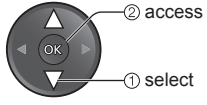
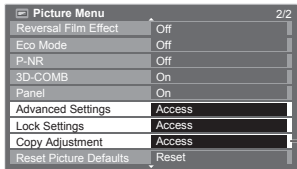

"Copy Adjustment" is available when "Viewing Mode" in the Picture Menu is set to "Professional1" or "Professional2"

6 Set (See below and next page)

To return to TV



Lock Settings Lock the picture setting

Advanced Settings can be locked for each Viewing Mode and input. Additionally, Backlight, Contrast, Brightness, Colour, Sharpness, Tint, and Reset Picture Defaults in the Picture Menu can be locked for "Professional1" and "Professional2".

1 Enter the PIN number (4 digits)



- Enter the PIN number twice at first setting.
- Make a note of the PIN number in case you forget it.

2 Select "Adjustment Lock" and set to "On"



To change the PIN number
Select "Change PIN"

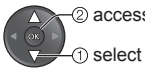

Enter a new PIN number twice



Advanced Settings Adjust the detailed picture settings

- To make settings → “How to Use Menu Functions” ① to ④ (p. 23)

| Advanced Settings | |
|-------------------------|-------|
| R-Gain | 0 |
| G-Gain | 0 |
| B-Gain | 0 |
| R-Cutoff | 0 |
| G-Cutoff | 0 |
| B-Cutoff | 0 |
| Gamma | 2.2 |
| Reset Advanced Settings | Reset |



| Menu | Item | Adjustments / Configurations (alternatives) |
|-------------------|--------------------------------|---|
| Advanced Settings | R-Gain | Adjusts the white balance of bright red area |
| | G-Gain | Adjusts the white balance of bright green area |
| | B-Gain | Adjusts the white balance of bright blue area |
| | R-Cutoff | Adjusts the white balance of dark red area |
| | G-Cutoff | Adjusts the white balance of dark green area |
| | B-Cutoff | Adjusts the white balance of dark blue area |
| | Gamma | Switches the gamma curve (1.8 / 2.0 / 2.2 / 2.4 / 2.6) |
| | Reset Advanced Settings | Press the OK button to reset to the default Advanced Settings |

For the mode of “Professional1” or “Professional2” in “Viewing Mode”

- White Balance
- Colour Management
- Gamma

| Advanced Settings | |
|-------------------|--------|
| White Balance | Access |
| Colour Management | Access |
| Gamma | Access |



| White Balance | |
|---------------------|-------|
| R-Gain | 0 |
| G-Gain | 0 |
| B-Gain | 0 |
| R-Cutoff | 0 |
| G-Cutoff | 0 |
| B-Cutoff | 0 |
| Reset White Balance | Reset |

| Colour Management | |
|-------------------------|-------|
| R-Hue | 0 |
| G-Hue | 0 |
| B-Hue | 0 |
| R-Saturation | 0 |
| G-Saturation | 0 |
| B-Saturation | 0 |
| Reset Colour Management | Reset |

| Gamma | |
|-------------|-------|
| Gamma | 2.2 |
| Reset Gamma | Reset |

| Menu | Item | Adjustments / Configurations (alternatives) | |
|--------------------|-------------------|---|---|
| Advanced Settings | White Balance | R-Gain | Adjusts the white balance of bright red area |
| | | G-Gain | Adjusts the white balance of bright green area |
| | | B-Gain | Adjusts the white balance of bright blue area |
| | | R-Cutoff | Adjusts the white balance of dark red area |
| | | G-Cutoff | Adjusts the white balance of dark green area |
| | | B-Cutoff | Adjusts the white balance of dark blue area |
| | | Reset White Balance | Press the OK button to reset to the default White Balance |
| | Colour Management | R-Hue | Adjusts the picture hue of red area |
| | | G-Hue | Adjusts the picture hue of green area |
| | | B-Hue | Adjusts the picture hue of blue area |
| | | R-Saturation | Adjusts the saturation of red area |
| | | G-Saturation | Adjusts the saturation of green area |
| | | B-Saturation | Adjusts the saturation of blue area |
| | | Reset Colour Management | Press the OK button to reset to the default Colour Management |
| | Gamma | Gamma | Switches the gamma curve (1.8 / 2.0 / 2.2 / 2.4 / 2.6) |
| Reset Gamma | | Press the OK button to reset to the default Gamma | |

Copy Adjustment Copy the settings to the other input

You can copy the selected “Professional1” or “Professional2” settings to that of the other input. The settings of Backlight, Contrast, Brightness, Colour, Sharpness, Tint and Advanced Settings will be copied. **Select the destination to copy to**

| Copy Adjustment | |
|-----------------|-----|
| Destination | All |

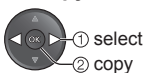

- You cannot copy to the locked mode.

Child Lock

You can lock specific channels / AV input terminals and control who watches them. When the locked channel / input is selected, a message appears; by entering the PIN number, you can watch it.

- 1 Display the menu**
MENU
- 2 Select "Setup"**
VIERA Main Menu
Picture
Sound
Setup
- 3 Select "Child Lock"**
Setup Menu 1/2
Off Timer Off
USB HDD Setup
Child Lock Access
Digital TV Tuning Menu
Display Settings
VIERA Link Settings
- 4 Set (see below)**

To return to TV
EXIT

Child Lock Control channel audience

- 1 Enter the PIN number (4 digits)**
Child Lock-PIN Entry
Please enter PIN for access
PIN

 - "0000" has been stored as the default PIN number.

- 2 Select "Child Lock List" or "Parental Rating"**
Child Lock
Change PIN
Child Lock List Access
Parental Rating No Block

To set "Child Lock List"

| Name | Input | Type | Lock |
|-----------------|------------|------------|------|
| 1 BBC1 | Digital TV | Digital TV | |
| 2 **** | Digital TV | Digital TV | |
| 7 BBC THREE | Digital TV | Digital TV | |
| 14 E4 | Digital TV | Digital TV | |
| 101 BBC 1 Wales | Digital TV | Digital TV | |
| AV1 | External | AV | |
| AV2 | External | AV | |

To set "Parental Rating"

- Parental Rating → p. 68

To change the PIN number
Select "Change PIN" in "Child Lock" and enter a new PIN number twice.

- Make a note of the PIN number in case you forget it.

Appears when the channel / input is locked

- To cancel
→ Select the locked channel / input → OK
- To lock all → G
- To cancel all locks → Y
- To jump to the top of the next input → R

Note

- Performing "Shipping Condition" (p. 38) erases the PIN number and all settings.
- If you have forgotten the PIN number which you have changed by yourself, input "6969" as the PIN number.
- Keep this Operating Instructions out of reach of children.

Input Labels

For easier identification and selection of the input mode, you can label each input terminals or skip terminal that is not connected to any equipment.

- To select the input mode → p. 20



1 Display the menu



2 Select "Setup"

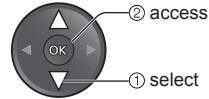
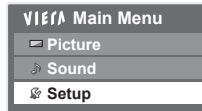

3 Select "Display Settings"

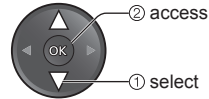
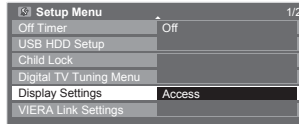

4 Select "Input Labels"

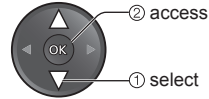
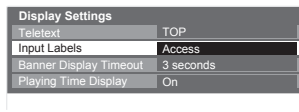

5 Select an input terminal and set

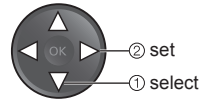
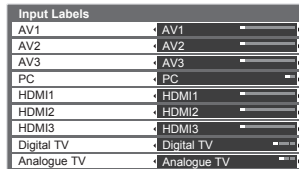

To return to TV



The labels you set will be displayed in "Input Selection" menu (p. 20) or banner.

- If "Skip" is selected, you cannot select the mode.

User input

You can name each input terminals freely.

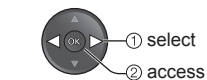

Select "User input"

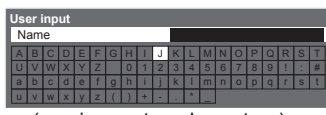

(maximum: ten characters)

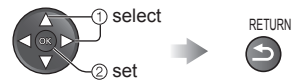

Set characters
You can set characters by using numeric buttons (p. 23).



Store

Shipping Condition (Reset settings)

Resets the TV to its original condition, i.e. no channels tuned in. All settings are reset (channels, picture, sound settings, etc.).

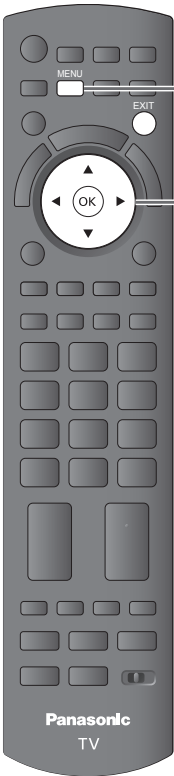

1 Display the menu



2 Select "Setup"

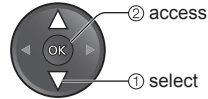
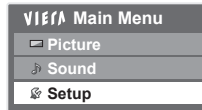

3 Select "System Menu"

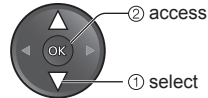
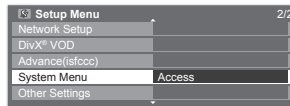

4 Select "Shipping Condition"

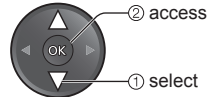
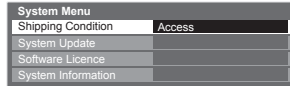

5 Set (see below)

To return to TV



Shipping Condition Reset Settings

① Check the message and reset

Shipping Condition

All tuning data will be erased
Are you sure?
Are you sure?

Confirm (confirm)
 EXIT
 RETURN

↓
 (confirm)
↓
 (start Shipping Condition)

② Follow the on screen instructions



Reset to Factory Shipping Condition Completed.
Please switch off TV.

- "Auto Tuning" will automatically start when Mains power On / Off switch is next turned On (p. 12).

To retune TV channels only, e.g. after moving house
→ "Auto Tuning" in "Tuning and Editing Channels" (p. 32, 33)

Updating the TV Software (Digital TV mode)

From time to time, a new version of software may become available for download to enhance the performance or operations of the TV. If there is an update available, a notification banner is displayed when the channel has the update information. This function is available in Digital TV mode.

- To download →  ● If you choose not to download → 
- You can update any new software automatically or manually.

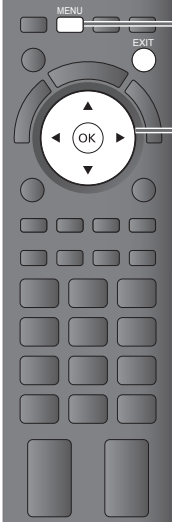

1 Display the menu



2 Select "Setup"

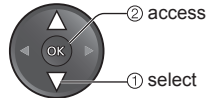
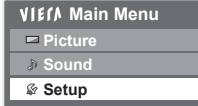

3 Select "System Menu"

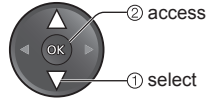
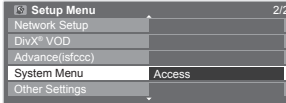

4 Select "System Update"

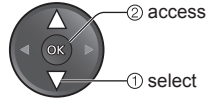
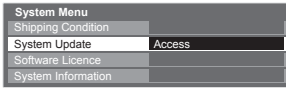





5 Set (see below)

To return to TV

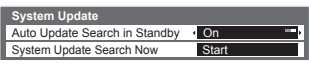
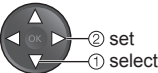

Shipping Condition (Reset settings)
Updating the TV Software (Digital TV mode)

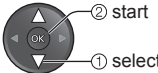
System Update Update TV's software system

| | |
|---|---|
| <h4>To update automatically</h4>   <p>Set "Auto Update Search in Standby" to "On"</p> <ul style="list-style-type: none"> ● Every time you set, the TV automatically performs a search in standby and downloads an update, if any software updates are available. ● The automatic updating is performed at 3:00 AM and 5:00 AM every morning under the following conditions: <ul style="list-style-type: none"> • Standby (TV turned Off with the remote control) • Direct TV Recording is not in progress. | <h4>To update immediately</h4>   <p>Select "System Update Search Now"</p> <p>Searches for an update (for several mins.) and displays a corresponding message if any</p> <p>Download </p> |
|---|---|

If System Update is performed, the software will be updated (it may change TV functions). If you do not wish to do so, set "Auto Update Search in Standby" to "Off".

Advanced

Note

- Download may take about 60 mins.
- During software download and update, DO NOT switch Off the TV or press any buttons. The TV will automatically be activated after downloading is completed.
- The message might be the notification beforehand. In this case, the schedule information (the date that the new version can be used) will appear. You can set the reservation for update. The update will not start when the TV is set to Off.
- A clicking sound will occur at 3:00 AM and 5:00 AM when "Auto update Search in Standby" is set to "On". This sound is normal.
- During downloading, the TV will display a blank screen for 40 to 50 seconds. Do not interrupt the TV during this procedure.

USB HDD Recording

You can record the digital TV programmes to the connected USB HDD and enjoy playing back in various ways.

- Analogue TV programme cannot be recorded to the USB HDD.
 - The data broadcasting (MHEG, etc.), radio broadcasting and the periods without any signal will not be recorded.
 - Not all the programmes can be recorded depending on the broadcaster and service provider.
 - This TV supports USB HDD with capacity from 160 GB up to 2 TB.
 - If the remaining capacity of the USB HDD is run out, the recording cannot be done.
 - Regarding the performance, not all USB HDDs are guaranteed.
- Check the recommended USB HDDs that have been tested for the performance with this TV at the following website. (English only)
<http://panasonic.jp/support/global/cs/tv/>

Caution

- Register the USB HDD with this TV in order to use it for recording. Please note that USB HDD will be formatted and all data (including the data from your PC, etc.) in it will be erased when you register it.
- In order to use the USB HDD with your PC after you use it with this TV for recording, format the drive on your PC. To format, refer to the manual of the PC. Please note that all data in the USB HDD will be erased when it is formatted.
- The data recorded to the USB HDD with this TV can only be played back on this TV. You cannot playback its contents with another TV (including the TV of the same model number) or any PCs.
- If your TV is repaired due to a malfunction, the registered USB HDD may not be available with your repaired TV. Register this USB HDD again to use it with your repaired TV. (All data in it will be erased.)

USB HDD connection

Connect the USB HDD to the USB 1 or 2 port socket outlet

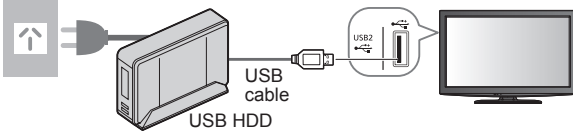

- Be sure to connect the USB HDD to the socket outlet.
- Do not turn off or disconnect the USB HDD during operation. It may cause malfunction of the drive or damage the recorded data.
- To remove the USB HDD safely from the TV → p. 41, 45

Setting for USB HDD

Register and setup the USB HDD with this TV in order to use it for recording. Connect the USB HDD before starting this settings. → “USB HDD connection” (above)

- Before the settings, be sure to turn on the USB HDD.
- You cannot change the settings for the USB HDD while recording is in progress.
- Please note that USB HDD will be formatted and all data in it will be erased when you register it.



1 Display the menu



2 Select “Setup”

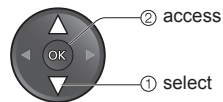
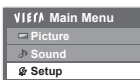

3 Select “USB HDD Setup”

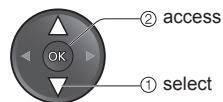
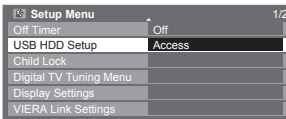

4 Select “Device Setup” and set (see next page)

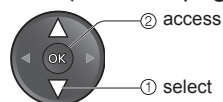
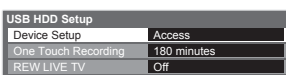

To return to TV



To return to the previous screen



Device Setup Register and setup the USB HDD

All the USB devices recognized as a mass storage device will be listed. You can only register USB HDDs.

- Up to 8 USB HDDs can be registered with this TV. However you can only choose one USB HDD for recording at a time.
- Some USB HDD may not be registered.

Select the USB HDD for recording and start registration / setup

| Connect | Product | Name |
|---------|----------------|------|
| Yes | USB Drive A | |
| Yes | USB Flash Disk | |
| | | |
| | | |
| | | |
| | | |
| | | |
| | | |



- For the information of the highlighted device



- Caution of USB HDD recording and playing back

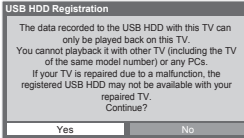

- Confirmation of USB HDD registration

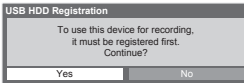

- Confirmation of USB HDD format

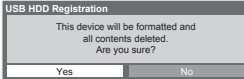

- Confirmation of USB HDD name

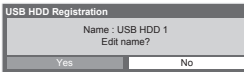

The name for the registered USB HDD is created automatically. If you want to edit the name, select "Yes".

Set characters one by one



Store

RETURN



- You can set characters by using numeric buttons → (p. 23)

- Confirmation to enable USB HDD for recording
If the registered USB HDD for recording already exists, this confirmation screen will be displayed to switch to enable this USB HDD for recording.

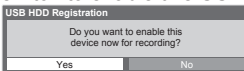

- The USB HDD is registered and available for recording / playing back if the connection status is "Yes". Only one registered USB HDD on the list can be available for recording.
- ▶ The USB HDD is registered and available for playing back if the connection status is "Yes".

| Connect | Product | Name |
|---------|----------------|-----------|
| Yes | USB Drive A | USB HDD 1 |
| Yes | USB Flash Disk | |
| | | |
| | | |
| | | |
| | | |
| | | |
| | | |

Name is displayed if the registration is completed

Connection status (Yes: connected / No: not connected)

To remove the USB HDD safely from the TV, ensure the status is "No" before removing.

- To change the status →
- You can also remove the USB HDD safely from Media Player → "Remove the USB devices safely" (p. 45)

To unregister the registered USB HDD

- Once you unregister the USB HDD, it will not be possible to playback any of the recorded content on any TV.

Select the USB HDD



Unregister



- The confirmation screen will be displayed twice. Select "Yes" to unregister.

USB HDD Recording

Recording the TV programme to USB HDD

You can record the current programme immediately by using “One Touch Recording”. You can also record the current programme constantly for the selected period by using “REW LIVE TV” so that you can go back or pause the current programme.

- Ensure the connection, registration and setup are completed before start recording ➔ p. 40 and p. 41
- Ensure not to connect or disconnect any USB devices during USB HDD recording. Otherwise the recording may not work properly.

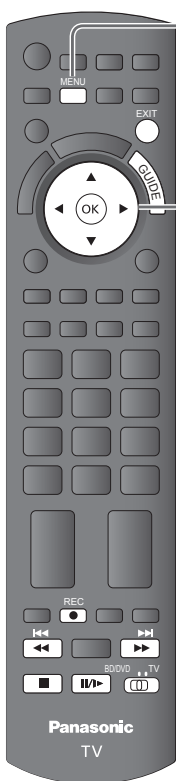

1 Display the menu



2 Select “Setup”

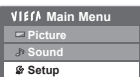

- ② access
- ① select

3 Select “USB HDD Setup”

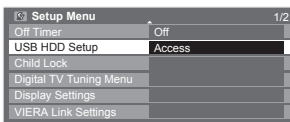

- ② access
- ① select

4 Select “One Touch Recording” or “REW LIVE TV”

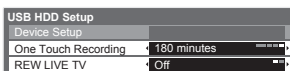

- ② access
- ① select

5 Set (see next page)

To return to TV



One Touch Recording Direct TV Recording - What you see is What you record

Recording the current programme in the USB HDD immediately.
 Select the maximum recording time (30 / 60 / 90 / 120 / 180 minutes)

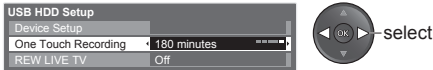

To start One Touch Recording

Set the position to "TV" Start



- No other channel can be selected while the recording is in progress.

To stop recording on the way



To playback or delete the recorded contents

➔ "Using Media Player" (p. 44)

- Even if One Touch Recording is in progress, you can playback all the contents. However, the recording may not work properly while playback.

REW LIVE TV Record constantly

Recording the current programme constantly.

Select "On" to start REW LIVE TV

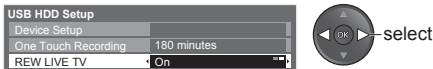

- When you select "On", the recording will start automatically.

To operate the REW LIVE TV

Set the position to "TV"



- To pause ➔

- To search backward ➔ (press and hold for about a second)

- After pausing or searching backward, the following buttons are available to operate.

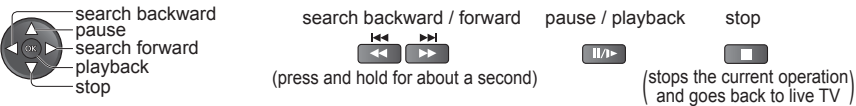

To stop the REW LIVE TV



- If you stop the REW LIVE TV, the recorded content for the REW LIVE TV will be deleted.

- REW LIVE TV will be stopped and the recorded content deleted automatically in the following conditions:
 (Even if REW LIVE TV stops for the following conditions, as long as the setting is "On", the new recording will start automatically in a condition that makes the recording available.)
 - selected other channels
 - selected locked channel
 - selected invalid channel
 - no TV signal
 - when the other recording starts
 - when the TV is turned off or standby

Using Media Player

Media Player allows you to enjoy photo, video or music recorded on an SD Card and a USB Flash Memory, and recorded contents on the registered USB HDD.

VIERA IMAGE VIEWER is the function of the easy viewing for photos or videos recorded on an SD Card on the TV screen by simply inserting into the SD card slot.

Photo mode : Still pictures recorded by digital cameras will be displayed.

Video mode : (For SD Card or USB Flash Memory) Moving pictures recorded by digital video cameras will be played back.
(For registered USB HDD) TV programmes recorded in USB HDD registered to this TV will be played back.

Music mode : Digital music data will be played back.

When these functions are used, the audio signal is output from audio output terminals, but video signals are not output.

- "Date" shows the date on which the recording was made by the recording equipment. The file without record of the date is shown "***/**/*****".

Data format for SD Card / USB Flash Memory browsing

- Photo : Still images recorded with digital still cameras compatible with JPEG files of DCF* and EXIF standards
Data format - Baseline JPEG (Sub-sampling 4:4:4, 4:2:2 or 4:2:0)
Image resolution - 8 × 8 to 30,719 × 17,279 pixels
- Video : SD-Video Standard Ver. 1.2 [MPEG-2 (PS format)] and AVCHD Standard compatible files with an audio format that is either MPEG-1/Layer-2 format or Dolby Digital format
(A modified data with a PC may not be displayed correctly.)
DivX ➔ p. 72
- Music : Data format - MP3 and AAC (Copy-protected files cannot be played back.)
- SD Card format : SDXC Card - exFAT
SDHC Card / SD Card - FAT16 or FAT32
- Compliant card type (maximum capacity): SDXC Card (64 GB), SDHC Card (32 GB), SD Card (2 GB), miniSD Card (2 GB) (requiring miniSD adapter)
- If miniSD Card is used, insert / remove it together with the adapter.
- Check the latest information on the card type at the following website. (English only)
<http://panasonic.jp/support/global/cs/tv/>
- USB Flash Memory format : FAT16, FAT32 or exFAT
(A USB HDD formatted by PC is not supported in Media Player.)





*DCF (Design rule for camera file system): Unified standard established by Japan Electronics and Information Technology Industries Association (JEITA).

Note

- Format the device with the recording equipment.
- The picture may not appear correctly on this TV depending on the recording equipment used.
- Display may take some time when there are many files and folders.
- This function cannot display Motion JPEG and still image not JPEG formatted (i.e. TIFF, BMP).
- A data modified with a PC may not be displayed.
- Images imported from a PC must be compatible with EXIF (Exchangeable Image File) 2.0, 2.1, and 2.2.
- Partly degraded files might be displayed at a reduced resolution.
- The folder and file names may be different depending on the digital camera or digital video camera used.
- Do not use two-byte characters or other special codes.
- The device may become unusable with this TV if the file or folder names are changed.

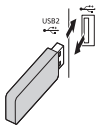
To insert or remove the SD Card / USB Flash Memory

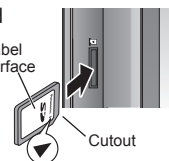
- For the USB HDD Connection ➔ p. 40

| | |
|--|--|
| <h3>USB Flash Memory</h3>  <ul style="list-style-type: none">● Insert or remove straightly and completely.● Before removing the USB Flash Memory, ensure to perform "Remove the USB devices safely" (p. 45) |  |
| <h3>SD Card</h3> <ul style="list-style-type: none">● To insert SD Card Gently insert the SD Card label surface facing front. Push until a click is heard● To remove SD Card Push the centre of the card   | |

Starting Media Player



1 Insert the SD Card or USB Flash Memory

- For registered USB HDD, ensure the connection status is "Yes".
➔ p. 41



2 Switch to Media Player

- When SD Card is inserted, switching will be done automatically.

3 Select the icon you want to access to



selected device name

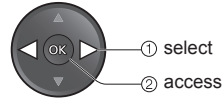

- If two or more devices are not connected, this step will be skipped.
- For the registered USB HDD, all the USB HDD of which the connection status is "Yes" is available.
➔ "Register and setup the USB HDD" (p. 41)

4 Select the content



- Photo ➔ "Photo mode" (p. 46)
- Video ➔ "Video mode" (p. 48)
- Music ➔ "Music mode" (p. 51)

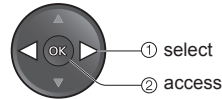

- For registered USB HDD, this step will be skipped and recorded contents list will be displayed. ➔ p. 49

To return to TV



To return to the previous screen



Change the device

You can change to the other device directly in the same mode if two or more devices are connected.

Display the menu
MENU

Select "Drive Select"



Appears if the USB device is connected to the TV.

Select the icon you want to access to



selected device name



Remove the USB devices safely

Before remove the USB devices, please take the following steps in order to protect the devices.

Display the menu
MENU

Select "USB Remove Safety"



Appears if the USB device is connected to the TV.

Select the USB Flash Memory or USB HDD to remove

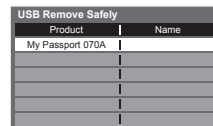

Using Media Player

Photo mode

Photo mode will read all “.jpg” extension files in the SD Card or USB Flash Memory. The thumbnail of all the photos in the SD Card or USB Flash Memory will be displayed.

Error display (titles that could not be loaded, etc.)



(Thumbnail - All photos)

- You can also access Photo mode directly by using VIERA TOOLS (p. 22).
- To change the background music → “Photo Setup” (p. 47)
- To display the information of the highlighted photo

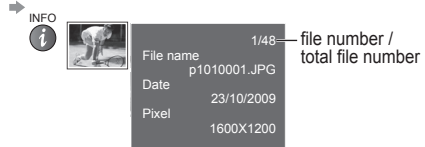

- To change the number of photos on a thumbnail screen at a time
→ Y (7 × 4 ↔ 10 × 6)

To sort by folder, recorded date or recorded month

Display the view selection



Select the sort type

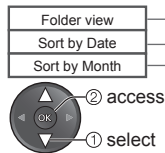

- Displays the thumbnail grouped by folder
 - The files which are not into a folder will be collected to the folder named “f”.
- Displays the thumbnail grouped by the same date
 - The group of the photos without recorded date is shown as “Unknown”.
- Displays the thumbnail grouped by the same month
 - The group of the photos without recorded date is shown as “Unknown”.

● To return to the thumbnail of all photos



Select one of the sorted group to display the thumbnail of the selected group



- To display the information of the highlighted group

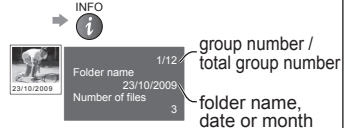

Single view - Display one photo at a time.

Select the file from the thumbnail of photos to be viewed



- To display / hide the operation guide



- To operate Single view

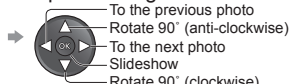

- To return to thumbnail view → RETURN



Slideshow - Slideshow will be completed within the thumbnail from which it was started.

Select the file from the thumbnail of photos for the first view



Start Slideshow



- To display / hide the operation guide → INFO

- To pause (return to Single view) → OK

- To return to thumbnail → RETURN



Photo Setup

Display the menu

MENU

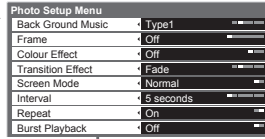

| Menu | Item | Adjustments / Configurations (alternatives) |
|-------------|-------------------|---|
| Photo Setup | Back Ground Music | <p>Selects the back ground music during the Photo mode (Off / Type1 / Type2 / Type3 / Auto / User)</p> <ul style="list-style-type: none"> Type1, Type2 and Type3 are the fixed music each installed in this TV. Auto : Music data stored in the root folder of the SD Card will be played back randomly. <ul style="list-style-type: none"> If there is no available music data, no sound will be produced. User : Music data in the current device registered by yourself in Music mode will be played back. <ul style="list-style-type: none"> To register the music ➔ "Set background music for Photo mode" (p. 51) If no music has been registered or the registered music device are removed, no sound will be produced. |
| | Frame | <p>Selects the indication frame of the slideshow (Off / Multi / Collage / Drift (+ calendar) / Drift / Gallery (+ calendar) / Gallery / Cinema)</p> <p>Multi : 9 division display like tiled design Collage : A photo is displayed at random position and random scale. Drift (+ calendar) / Drift : Photos are displayed like flow images. <ul style="list-style-type: none"> You can select to display the calendar or not. The month of calendar is turned by pressing up or down cursor button. Gallery (+ calendar) / Gallery : The various size of photos in the frame are displayed. <ul style="list-style-type: none"> You can select to display the calendar or not. The month of calendar is turned by pressing up or down cursor button. Cinema : Photos are displayed like old films (sepia tone)</p> |
| | Colour Effect | <p>Selects the colour effect of photos (Off / Sepia / Gray scale)</p> <ul style="list-style-type: none"> This function is not available when "Frame" is set to "Drift", "Gallery" or "Cinema". |
| | Transition Effect | <p>Selects the transition effect for switching the photo during the slideshow (Off / Fade / Slide / Dissolve / Motion / Random)</p> <p>Fade : The next photo fades in gradually. Slide : The next photo slides and appears from the left side. Dissolve : The photo is replaced by an indefinite block unit. Motion : The photo is replaced with enlarged, reduced, moved up or moved down. Random : Each transition is selected at random. <ul style="list-style-type: none"> This function is available when "Frame" is set to "Off". </p> |
| | Screen Mode | <p>Selects whether enlarged or normal viewing on Single view and Slideshow (Normal / Zoom)</p> <ul style="list-style-type: none"> This function is not available when "Frame" is set to "Collage", "Drift", "Gallery" or "Cinema". This function is not available when "Transition Effect" is set to "Motion". Depending on the photo size, the photo may not be enlarged. |
| | Interval | <p>Selects slideshow interval (5 / 10 / 15 / 30 / 60 / 90 / 120 seconds)</p> <ul style="list-style-type: none"> This function is not available when "Frame" is set to "Drift", "Gallery" or "Cinema". This function is not available when "Transition Effect" is set to "Motion". |
| | Repeat | Slideshow repeat (Off / On) |
| | Burst Playback | <p>Selects whether the continuous shots are displayed in rapid interval during the slideshow (Off / On)</p> <ul style="list-style-type: none"> This function is not available when "Frame" is set to "Drift", "Gallery" or "Cinema". This function is not available when "Transition Effect" is set to "Motion". |

Change the contents

You can switch to the other mode of Media Player from the thumbnail.

- The mode can be switched in the current device.
- To change the device ➔ "Change the device" (p. 45)

While the thumbnail is displayed, display the contents selection



Select the contents



- Photo ➔ "Photo mode" (p. 46)
- Video ➔ "Video mode" (p. 48)
- Music ➔ "Music mode" (p. 51)

Using Media Player

Video mode

For SD Card or USB Flash Memory

Video mode supports AVCHD, MPEG2 and DivX® file formats.

Film icon will be displayed if the file does not support thumbnail view.

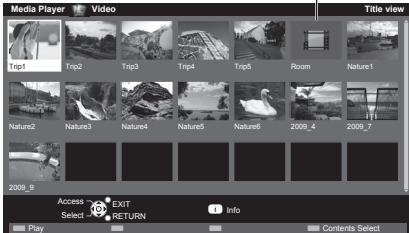

(Thumbnail - Title view)

The thumbnail of video titles in the SD Card or USB Flash Memory will be displayed. The preview will start when the title is highlighted if it supports a preview.

- You can also access Video mode directly by using VIERA TOOLS (p. 22).
- To off the preview → "Video Setup" (p. 50)
- To display the information of the highlighted title

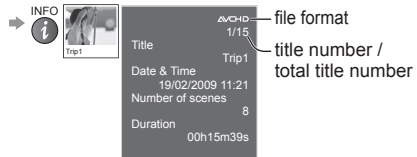

Playback from Title view

Playback of the selected title will start.

Select the title → Start playback



Playback from the selected scene in the title (AVCHD or MPEG2)

Playback will start from the selected scene to the end of the title.

Select the title → Select the scene to start playback

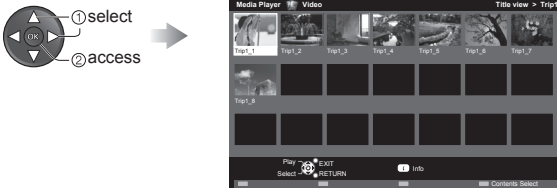

(Thumbnail - Scene view)



The preview will start when the scene is highlighted if it supports a preview.

- To turn off the preview → "Video Setup" (p. 50)

- To repeat playback

→ "Video Setup" (p. 50)

- To display the information of the highlighted scene

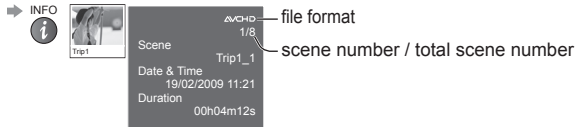

How to operate during the playback

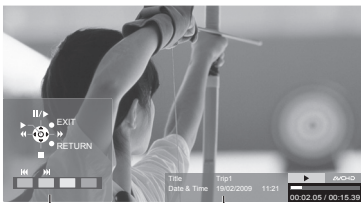

Operation guide information banner (Playback)

- To display / hide the operation guide and information banner



- To operate the playback

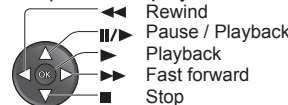

- To change aspect (only for the 4:3 video content)



- To the previous scene → R

- To the next scene → G

- To return to thumbnail → RETURN

- You can also use the following buttons. Set the position to "TV"



- To confirm or change the current status (if available) → OPTION



For registered USB HDD

Remaining capacity of the HDD
 ● This value may not be accurate depending on the condition.

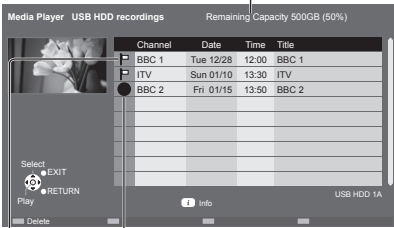

Contents list of the registered USB HDD will be displayed.

● You can also access the contents list directly by using VIERA TOOLS (p. 22).

● To display the information of the highlighted content



Content under recording

Content not played back

● Once you playback the content, this icon will disappear.

Playback the content from the list

Select the content

Start playback



Delete the selected content

Select the content

Delete the content



How to operate in the playback



Operation guide

information banner

(Playback)

● To display / hide the operation guide and information banner → INFO

● To change aspect → ASPECT

● To operate the playback

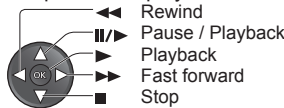

● To return to list → RETURN

● To display the subtitle (if available) → STTL

● You can also use the following buttons. Set the position to "TV"



● To confirm or change the current status (if available) → OPTION

Note

● Depending on the recorded programmes, some playback operations may not work properly.

Using Media Player

Sound Settings

You can enjoy the multi-channel sound via an amplifier connected to DIGITAL AUDIO OUT terminal.

To confirm or change the current sound status (during playback)

Display the Option menu

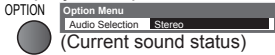

Change the sound (if the video has multiple audio signals)



- It may take several seconds to change the sound.

Audio output settings

Display the menu



Select "Sound"

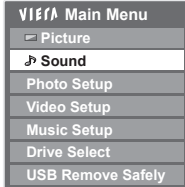

Select "SPDIF Selection" and set

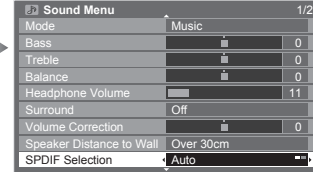

| Menu | Item | Adjustments / Configurations (alternatives) |
|-------|-----------------|---|
| Sound | SPDIF Selection | <p>SPDIF : A standard audio transfer file format Selects the initial setting for digital audio output signal from DIGITAL AUDIO OUT terminal (Auto / PCM) Auto: Dolby Digital is output as Dolby Digital Bitstream. MPEG is output as PCM. PCM: Digital output signal is fixed to PCM.</p> |

Video Setup Setup for Video mode

Display the menu



Select "Video Setup"



Select "Other Settings"



Select the items and set

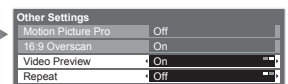

| Menu | Item | Adjustments / Configurations (alternatives) |
|-------------|----------------|--|
| Video Setup | Other Settings | |
| | Video Preview | <p>Sets to start the preview of the title or scene in the thumbnail screen (Off / On) ● Image may not be displayed for an instant in the thumbnail screen. Set the preview "Off" to resolve this.</p> |
| | Repeat | <p>● Playback repeat within the title (Off / On)</p> |

Music mode

Music mode supports MP3 and AAC file format.

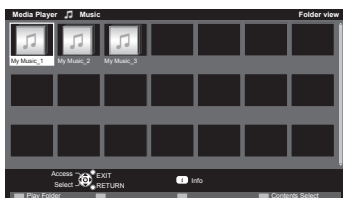

The thumbnail of music folders in the SD Card or USB Flash Memory will be displayed.

- You can also access Music mode directly by using VIERA TOOLS (p. 22).

To display the information of the highlighted title

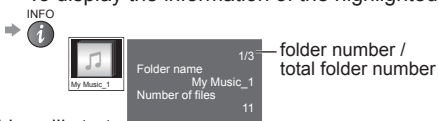

Playback from Folder view

Playback all the files in the selected folder will start.

Select the folder → Start playback



Playback from File view

Playback of the selected file will start.

Select the folder → Select the file to start playback

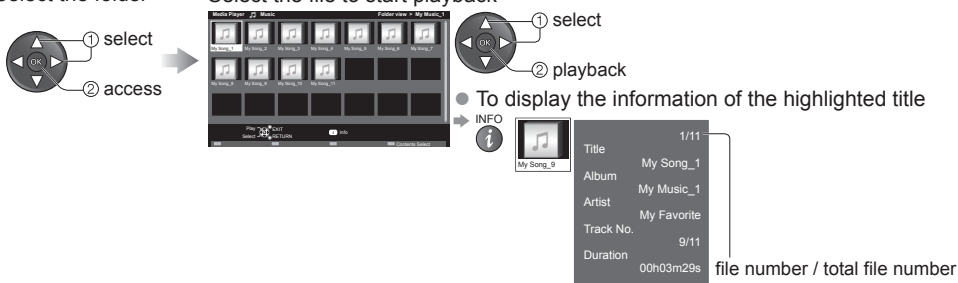

How to operate in the playback

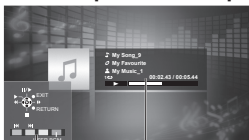

Operation guide (Playback) information banner

- To display/ hide the operation guide → INFO
- To operate the playback :
 - Rewind
 - Pause / Playback
 - Playback
 - Fast forward
 - Stop
- To the previous track → R
- To the next track → G
- To return to thumbnail → RETURN

Music Setup

Setup the setting for Music mode.

Display the menu → Select "Music Setup"

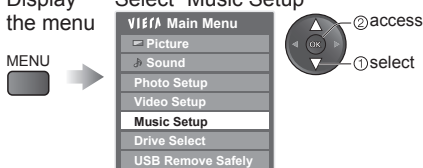

Set



Folder : Playback repeat within the selected folder
One : Playback repeat of the selected one file

Set background music for Photo mode

You can register your favourite music as background music for Photo mode.

- Select "User" in "Back Ground Music" → "Photo Setup" (p. 47)
- If you remove the device in which the registered music is stored, the setting of "User" will be reset.

While playing music, display the selection screen



File : The current music will be registered as back ground
Folder : All the music in the current folder will be registered as back ground music.

Using Network Services

(DLNA / VIERA CAST)

DLNA®

This TV is a DLNA Certified™ product.

DLNA (Digital Living Network Alliance) is a standard that makes DLNA Certified digital electronics easier and more convenient to use on a home network. To learn more, visit www.dlna.org.

It allows you to share photos and video stored in the DLNA Certified media server (for example, PC with windows 7 installed, DIGA Recorder etc.) connected to your home network, and enjoy watching them on the TV screen.

Applicable data format

Photo : JPEG (Sub-sampling 4:4:4, 4:2:2 or 4:2:0)

Image resolution - 8 × 8 to 30,719 × 17,279 pixels

- MOTION JPEG and Progressive JPEG are not supported.

Video : MPEG-2 (PS format and TS format)

- AVCHD and DivX files are not supported by DLNA, but can be played by Media Player (p. 48).
- Music files are not supported by DLNA, but MP3 and AAC files can be played back by Media Player (p. 51).

Media server

Ensure the connected equipment has a DLNA Certified media server.

To use the PC, install the server software on the PC for obtaining a media server.

Store photos or videos into the media server, and then you can watch them on the TV.

“TwonkyMedia” and “Windows 7” are the server software that has been tested for the performance with this TV (current as of January, 2010).

For installing, read the manual of the server software.

- The DLNA control function of Windows 7 is not supported with this TV.
- When a server software for the media server is installed on the PC, the data may be at risk of being accessed by other people. Please take care of the settings and connections under the network circumstances at the office, hotel or even at home when not using a router.

By connecting a DLNA compatible DIGA Recorder to your home network, you can enjoy and control it as one of the media servers.

- For details, read the manual of the DIGA Recorder.

Network connection

- ➔ Example 1 or Example 2 in “Network connections” (p. 53)

Network setup

- ➔ p. 54 - p. 56

DLNA operations

- ➔ p. 57 - 59

VIERA CAST™

VIERA CAST is a gateway to the internet services unique to Panasonic.

By connecting the TV to the internet environment, VIERA CAST allows you to enjoy internet content on the TV screen such as photos, movies, weather, etc. from VIERA CAST home screen.

You can access VIERA CAST home screen directly by pressing the VIERA CAST button on the remote control.

Network connection

- ➔ Example 1 or Example 3 in “Network connections” (p. 53)

Network setup

- ➔ p. 54 - p. 56

VIERA CAST operations

- ➔ p. 60

Network connections

- If you do not have a Broadband network service, please consult your retailer for assistance.
- Confirm the terms and conditions of the contracts with your Internet Service Provider (ISP) or telecommunications company.
- Set up and connect any equipment required for the network environment.
- Required speed (effective): at least 1.5 Mbps for SD and 6 Mbps for HD picture quality, respectively.
- Read the manual of the network equipment, too.

Example 1

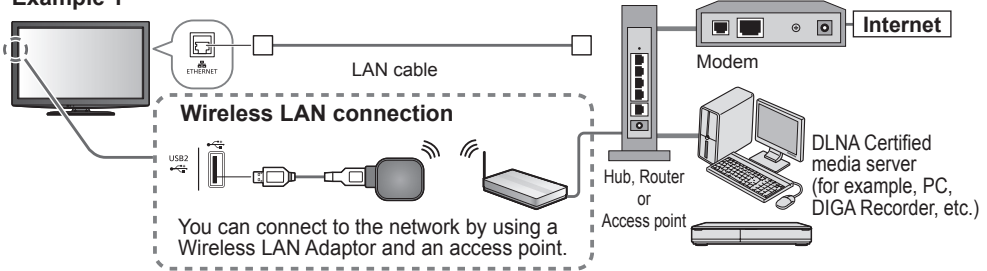

- Ensure to use a LAN straight cable for this connection.
- If your modem has no broadband router functions, use a broadband router.
- If your modem has broadband router functions but there are no vacant ports, use a hub.
- Ensure that the Broadband routers and hubs are compatible with 10BASE-T / 100BASE-TX.
- If you use the equipment compatible only with 100BASE-TX, category 5 LAN cables are required.

Example 2

You can connect the TV and the equipment directly to use DLNA features.

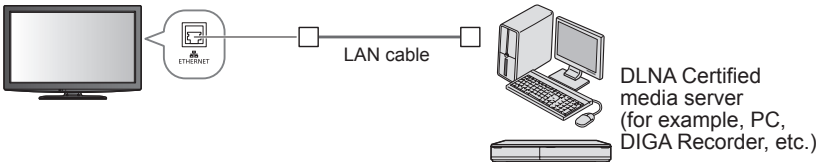

- Ensure to use a LAN cross cable for this connection.

Example 3

You can connect the TV and the telecommunication equipment directly to use VIERA CAST features.

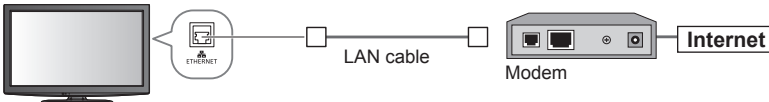

Note

- Depending on the ISP or telecommunications company, the required equipment and the internet connection procedure are different. Ensure that you use the network equipment that are authorized by your ISP and telecommunications company.
- You cannot make settings for the network equipment on this TV. You may be required to make settings on your computer.
- Depending on the terms and conditions of the contracts with your ISP or telecommunications company, additional fees may be charged or multiple connections to the internet may be impossible.
- Please contact your ISP or telecommunications company if you require further assistance regarding the network equipment.

Using Network Services

(DLNA / VIERA CAST)

Network Setup

- Ensure the connections are completed before starting Network Setup.
 - ➔ “Network connections” (p. 53)



1 Display the menu



2 Select “Setup”

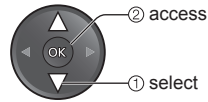
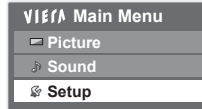

3 Select “Network Setup”

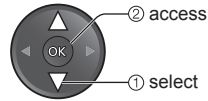
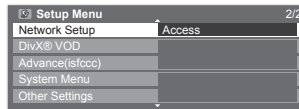

To return to TV



4 Set (see below and next page)

Edit the name of this TV

You can set your favourite name for this TV. This name will be used to display the name of this TV on the screen of the other DLNA compatible equipment.

Select “VIERA Name”

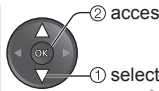
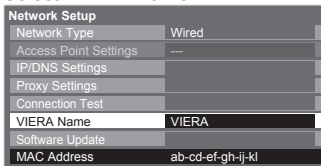

Edit the name
Set characters one by one

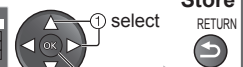

Store

- You can set characters by using numeric buttons.
 - ➔ (p. 23)

Update TV's software

Accesses the specific web site to update TV's software and search if any software updates are available.

Select “Software Update”

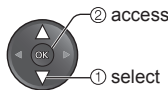
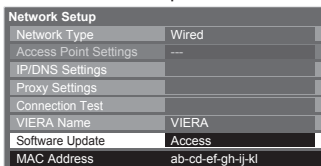

- Follow the on screen instructions

Note

MAC Address

- MAC address is a unique address that identifies hardware in the network. (for information only)

| Network Setup | |
|-----------------------|-------------------|
| Network Type | Wired |
| Access Point Settings | --- |
| IP/DNS Settings | --- |
| Proxy Settings | --- |
| Connection Test | --- |
| VIERA Name | VIERA |
| Software Update | Access |
| MAC Address | ab-cd-ef-gh-ij-kl |

Network settings for the LAN Cable connection

This setting is for the network connection by using the LAN cable.

① Select "Network Type" and set to "Wired"

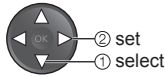
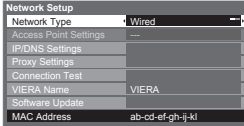

If you make the network connection like "Example2" (p. 53), you do not have to set "Acquire DNS Address", "Proxy" and "Proxy Port".

② Select "IP/DNS Settings" and set the items

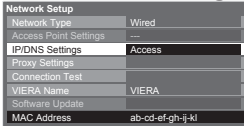

After settings, return to "Network Setup" screen → RETURN

Acquire IP Address Acquire DNS Address

Sets IP Address, Subnet Mask, Gateway, Primary DNS and Secondary DNS.

For most users, the recommended method of connection to your network is by using Auto feature.

Select "Acquire IP Address" and then set to "Auto"

Select "Acquire DNS Address" and then set to "Auto"

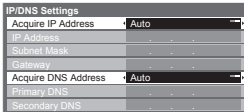

- The available settings are displayed automatically.

Manual settings

If you wish to set these functions manually, select "Manual".

Select "IP Address", "Subnet Mask", "Gateway", "Primary DNS" or "Secondary DNS"



③ Select "Proxy Settings" and set the items

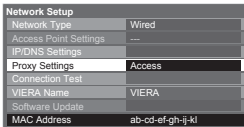

After settings, return to "Network Setup" screen → RETURN

Proxy

Sets Proxy address.

- This is the address of the relay server that is connected to the target server instead of the browser and sends data to the browser. Setting is required if specified by the provider.

Select "Proxy"

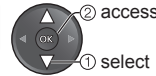
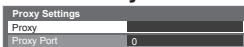

Enter the address

Set characters one by one

Store



- You can set characters by using numeric buttons.

Proxy Port

Sets Proxy port number.

- This number is also specified by the provider with the Proxy address.

Select "Proxy Port"



Move the cursor and enter the number

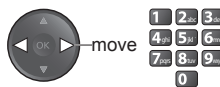

④ Select "Connection to Test" and access to test

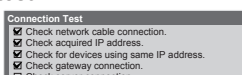
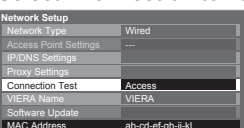

- succeeded**
The test is successful and the TV is connected to the network.
- failed**
Check the settings and connections, and then perform this function again

Performs automatic testing of the network connection for the TV. (It takes a while to test.)

Using Network Services (DLNA / VIERA CAST)

Network settings for the Wireless LAN connection

This setting is for the network connection by using Wireless LAN Adaptor.

① Select "Network Type" and set to "Wireless"

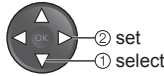
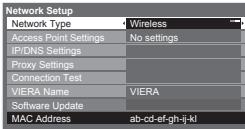

② Select "Access Point Settings"

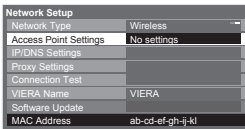

③ Select the connection method and set

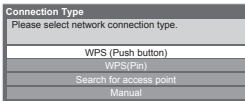

WPS(Push button) → p. 13

WPS(PIN) : Sets by entering the PIN code to the access point

Search for access point → p. 13

Manual : Sets manually by entering the SSID of access point

④ Confirm the connection status of "Access Point Settings"

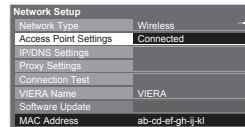

--- : "Wired" is selected in "Network Type".

No adaptor : Wireless LAN Adaptor is not connected.

No settings : Setting to connect to the access point has not been set.

Connecting... : Connecting to the access point in progress.

Connected : Wireless LAN connection to the access point succeeded.

- To display the current access point settings, press the OK button.

To change the settings, select "No" on this screen.

- Some access points do not allow access to the internet. Perform "Connection Test" (below) to check if internet connection is available.

USB

overcurrent : Overcurrent error

⑤ Select "Connection Test" and access to test

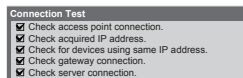
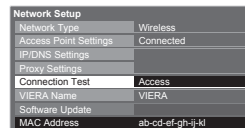

: **succeeded**

The test is successful and the TV is connected to the network.

: **failed**

Check the settings and connections, and then perform this function again.

If you continue to have difficulty, please contact your internet service provider.

Performs automatic testing of the network connection for the TV. (This may take some time.)

Using DLNA® features

- Ensure the preparation of media server, network connections and network settings are completed.
 - ➔ “Media server” (p. 52), “Network connections” (p. 53), “Network Setup” (p. 54 - 56)



1 Display the input selection menu

AV

2 Select “Media Server”

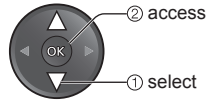
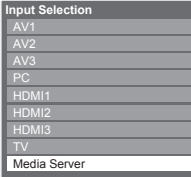

- You can also access directly by using VIERA TOOLS (p. 22).

3 Select one of the media servers you want to access

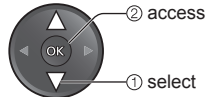
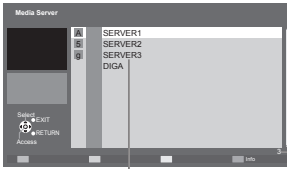

- To display the information of the highlighted media server

➔ INFO or B

To return to TV



To return to the previous screen



4 Select the file to be viewed

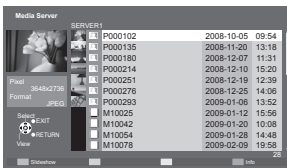

(File list)

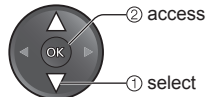

- Depending on the conditions of media server, you may need to select the folder before selecting the file.

- Slideshow ➔ p. 58

- To display the information of the highlighted file

➔ INFO or B

(See next page)

Using Network Services

(DLNA / VIERA CAST)

For photo file

Single view - Displayed one at a time



- To display / hide the operation guide → INFO
- To operate Single view
 - To the previous photo
 - Rotate 90° (anti-clockwise)
 - To the next photo
 - Slideshow
 - Rotate 90° (clockwise)
- To return to list → RETURN

Slideshow - Slideshow will be started from the selected photo file and completed within the list.

Start Slideshow



- To display / hide the operation guide → INFO
- To pause (return to Single view) → OK
- To return to list → RETURN

For video file

Playback - Playback will start.

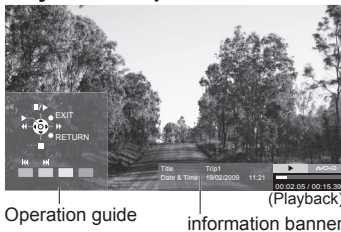

- To display / hide the operation guide and information banner → INFO
- To operate the playback
 - ◀◀ Rewind
 - ⏸ Pause / Playback
 - ▶▶ Playback
 - ▶▶ Fast forward
 - Stop
- To the previous scene → R
- To the next scene → G
- To change aspect (only for the 4:3 video content) → ASPECT
- To return to list → RETURN

For DIGA Recorder

Control the DIGA Recorder

The screen of the DIGA Recorder will be displayed. You can control the functions of the DIGA Recorder with this TV remote control according to the operation guide.

- Before operating, register this TV on the DIGA Recorder.
- For details, read the manual of the DIGA Recorder.

Example:

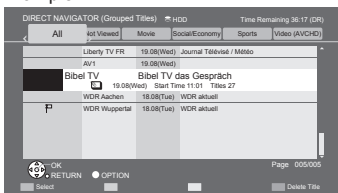

Photo Setup (for photo contents)

Setup the settings for Photo mode.

Display the menu



Select "Photo Setup"

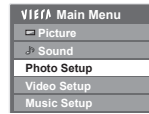

Select the items and set

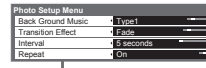

| Menu | Item | Adjustments / Configurations (alternatives) |
|-------------|-------------------|---|
| Photo Setup | Back Ground Music | <p>Selects the back ground music while photo (Off / Type1 / Type2 / Type3 / User)</p> <ul style="list-style-type: none"> Type1, Type2 and Type3 are the fixed music each installed in this TV. User: Music data registered by yourself in Music mode will be played back. <ul style="list-style-type: none"> To register the music → "Set background music for Photo mode" (p. 51) Only available music files can be registered. If no music has been registered or you change to the other media server, no sound will be produced. |
| | Transition Effect | <p>Selects the effect for switching the photo during the slideshow (Off / Fade / Slide / Dissolve / Motion / Random)</p> <p>Fade : The next photo fades in gradually. Slide : The next photo slides and appears from the left side. Dissolve: The photo is replaced by an indefinite block unit. Motion : The photo is replaced with enlarged, reduced, moved up or moved down. Random: Each transition is selected at random.</p> |
| | Interval | Selects slideshow interval (5 / 10 / 15 / 30 / 60 / 90 / 120 seconds) |
| | Repeat | Slideshow repeat (Off / On) |

Sound Settings (for video contents)

You can enjoy the multi-channel sound via an amplifier connected to DIGITAL AUDIO OUT terminal.

To confirm or change the current sound status (during playback)

Display the Option menu



Example:



Change the sound (if the video has multiple audio signals)



● It may take several seconds to change the sound.

Audio output settings

Display the menu



Select "Sound"



Select "SPDIF Selection" and set

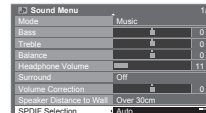

| Menu | Item | Adjustments / Configurations (alternatives) |
|-------|-----------------|--|
| Sound | SPDIF Selection | <p>SPDIF : A standard audio transfer file format</p> <p>Selects the initial setting for digital audio output signal from DIGITAL AUDIO OUT terminal (Auto / PCM)</p> <p>Auto: Dolby Digital is output as Dolby Digital Bitstream. MPEG is output as PCM. PCM: Digital output signal is fixed to PCM.</p> |

Using Network Services

(DLNA / VIERA CAST)

VIERA CAST™

You can access a selection of internet services from VIERA CAST home screen. For example, YouTube, Picasa Web Albums (current as of March, 2010).

- VIERA CAST requires a broadband internet connection. Dial-up internet connections cannot be used.
- Ensure the network connections and network settings are completed.
 - ➔ "Network connections" (p. 53), "Network Setup" (p. 54)



Access VIERA CAST



- Depending on the usage conditions, it may take a while to read all the data.
- Messages might be displayed before VIERA CAST home screen. Please read the instructions carefully and follow the on screen instructions.
- You can also access VIERA CAST by using VIERA TOOLS (p. 22).

Example:



VIERA CAST home screen

- Video communication requires an exclusive Communication Camera TY-CC10W (optional accessory ➔ p. 7). For details, read the manual of the Communication Camera.

EXIT

To return to TV ➔

How to operate VIERA CAST (current as of March, 2010)

- To go to the next level ➔ Select "MORE"
- To back to the previous level ➔ Select "BACK"
- To move the cursor / select the item ➔
- To access ➔
- To return to the previous screen ➔
- To return to VIERA CAST home screen ➔
- When the key words are displayed on colour bar ➔
- When options with numbers are displayed ➔

- Setup menu (Items in the "Setup" may change without notice.)

| | |
|-----------------------------|---|
| Customize HomeScreen | Changes the position of each services on VIERA CAST home screen |
| My Account | Confirms or removes the account information of the TV you entered on VIERA CAST |
| Lock | Sets to restrict access to some services |
| Beep | Sets beep sound On or Off when operating VIERA CAST |
| Notices | Displays the information of VIERA CAST |

USB keyboard

You can input characters on VIERA CAST screen by using the USB Keyboard connected to the USB port.

- You cannot use two or more keyboards simultaneously.
- The USB Keyboard which requires the driver is not supported.
- Characters may not be displayed correctly on the TV screen depending on the connected keyboard.

Note

- Be sure to update the software when a software update notice is displayed on the TV screen. If the software is not updated, you will not be able to use VIERA CAST. You can update the software later manually ➔ "Software Update" in the Network Setup Menu (p. 54)
- VIERA CAST™ home screen is subject to change without notice.
- The services through VIERA CAST™ are operated by their respective service providers, and service may be discontinued either temporarily or permanently without notice. Therefore, Panasonic will make no warranty for the content or the continuity of the services.
- All features of websites or content of the service may not be available.
- Some content may be inappropriate for some viewers.
- Some content may only be available for specific countries and may be presented in specific languages.
- Depending on the connection environment, the internet connection may be slow or may not be successful.
- Turn the TV off, and then on again when changing or reconnecting the network connection.

VIERA Link Functions

VIERA Link "HDAVI Control"™

Enjoy additional HDMI interoperability with Panasonic products which have "HDAVI Control" function. This TV supports "HDAVI Control 5" function.

Connections to the equipment with HDMI cable such as DIGA Recorder, HD Video Camera, Player theatre, Amplifier, etc., allow you to interface them automatically.

These features are limited to models incorporating "HDAVI Control" and "VIERA Link".

- Some functions are not available depending on the equipment's version of HDAVI Control. Please confirm the connected equipment's version of HDAVI Control.
- VIERA Link "HDAVI Control", based on the control functions provided by HDMI which is an industry standard known as HDMI CEC (Consumer Electronics Control), is a unique function that we have developed and added. As such, its operation with other manufacturers' equipment that supports HDMI CEC cannot be guaranteed.
- Please refer to individual manuals for the equipment. About applicable Panasonic equipment, consult your local Panasonic dealer.

Summary of features

| Features | Connected equipment with VIERA Link function | DIGA Recorder*1 | DVD Player / Blu-ray Disc Player*1 | HD Video Camera / LUMIX Camera*1 | Player theatre*2 | Blu-ray Disc theatre*2 | Amplifier*2 |
|---|--|-----------------|------------------------------------|----------------------------------|------------------|------------------------|-------------|
| Channel download | | ○*4 | — | — | — | — | — |
| Easy playback | | ○ | ○ | ○ | ○*7 | ○*7 | — |
| Power on link | | ○ | ○ | ○ | ○ | ○ | — |
| Power off link | | ○ | ○ | ○ | ○ | ○ | ○ |
| Reduce unnecessary power consumption in standby | | ○*5 | ○*5 | — | — | ○*5 | — |
| Auto standby for unnecessary equipment | | ○*3 | ○*3 | — | ○*3 | ○*3 | ○*3 |
| Pause Live TV programme | | ○*4 ○*6 | — | — | — | — | — |
| Direct TV Recording | | ○*4 | — | — | — | — | — |
| Control the menu of the connected equipment by VIERA remote control | | ○*3 | ○*3 | ○*3 | ○*3 | ○*3 | ○ |
| Speaker control | | — | — | — | ○ | ○ | ○ |

*1: HDMI Connection only

*2: HDMI and Audio out connections

*3: available with the equipment which has "HDAVI Control 2 or later" function

*4: available with the equipment which has "HDAVI Control 3 or later" function

*5: available with the equipment which has "HDAVI Control 4 or later" function

*6: available with DIGA Recorder which has HDD

*7: while playback a disc

*8: except for watching a disc

Connection

- To use DIGA Recorder / DVD Player / Blu-ray Disc Player / HD Video Camera / LUMIX Camera

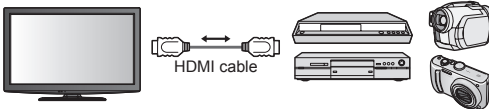

- To use Player theatre / Blu-ray Disc theatre:
- To use Amplifier:

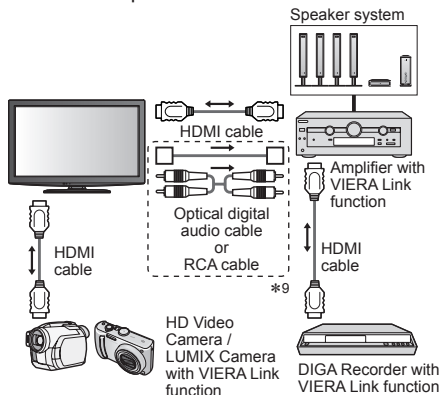
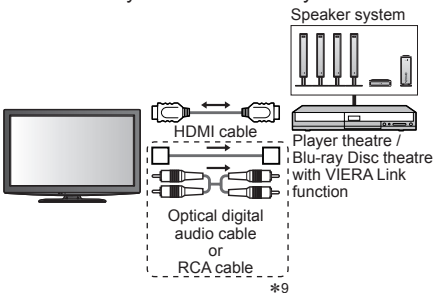

*9: If the connected equipment has "HDAVI Control 5" function, you do not have to use this audio cable (Optical digital audio cable or RCA cable). In this case, connect the equipment to the TV's HDMI2 terminal via an HDMI cable.

VIERA Link Functions

Note

- This function may not work properly depending on the connected equipment.
- For DIGA Recorder / DVD Player / Blu-ray Disc Player / HD Video Camera / LUMIX Camera with VIERA Link function, connect to HDMI1, HDMI2 or HDMI3 terminal via an HDMI cable.
- For Player theatre / Blu-ray Disc theatre / Amplifier, connect to HDMI1, HDMI2 or HDMI3 or terminal via an HDMI cable and/or either the optical digital audio cable or RCA cable for audio output from the TV.
- Use fully wired HDMI compliant cable. Non-HDMI-compliant cables cannot be utilized.
Recommended Panasonic's HDMI cable part number:
 - RP-CDHS15 (1.5 m)
 - RP-CDHS30 (3.0 m)
 - RP-CDHS50 (5.0 m)

Preparations

- Connect the equipment supporting VIERA Link.
- Set up the connected equipment. Read the manual of the equipment.
- For optimal recording, the settings of the recorder might be required. For details, read the manual of the recorder.
- Set VIERA Link On in Setup Menu ➔ "VIERA Link" (p. 28)
- Set up the TV ➔ **After connection, turn the equipment on and then switch the TV on. Set the input mode to HDMI1, HDMI2 or HDMI3 (p. 20), and make sure that an image is displayed correctly.**
This setup should be done each time when the following conditions occur:
 - for the first time
 - when adding or reconnecting equipment
 - when changing setup

Features available

Channel download

Channel setting can be downloaded to the recorder.

Easy playback

Automatic input switching - When the connected equipment is operated, input mode is switched automatically.

Power on link

Set Power on Link "On" in Setup Menu to use this function ➔ "Power on Link" (p. 28)

When the connected equipment starts playback or direct navigator / function menu for the equipment are activated, the TV is automatically turned on. (Only when the TV is in Standby mode.)

Power off link

Set Power off Link "On" in Setup Menu to use this function ➔ "Power off Link" (p. 28)

When the TV is set to Standby mode, the connected equipment is also automatically set to Standby.

- This function will work even if the TV enters standby mode automatically by Off Timer function or auto power standby function.

Standby Power Save Reduce unnecessary power consumption in standby

Set Standby Power Save "On" in the Setup Menu to use this function

➔ "Standby Power Save" (p. 28)

The power consumption in Standby mode of the connected equipment is controlled higher or lower in synchronization with the TV On / Off state to reduce the consumption.

When the TV is set to Standby mode, the connected equipment is automatically set to Standby and the power consumption in Standby mode of the connected equipment is automatically minimized.

When the TV is turned on, the connected equipment is still in Standby mode, but the power consumption is increased to make startup time early.

- This function is effective if the connected equipment can change the power consumption in Standby mode and is set to higher consumption.
- This function will work when "Power off Link" is set to "On".

Intelligent Auto Standby Auto standby for unnecessary equipment

Set Intelligent Auto Standby "On (With reminder)" or "On (No reminder)" in the Setup Menu to use this function ➔ "Intelligent Auto Standby" (p. 28)

When the TV is On, non-watched or non-used connected equipment goes into Standby mode automatically to reduce the power consumption. For example, when the input mode is switched from HDMI, when Speaker Selection is changed to "TV" (except for watching a disc).

- If you select "On (With reminder)", the on screen message will be displayed to be noticed before working this function.
- This function may not work properly depending on the connected equipment. If required, set to "Off".

Features available (Using VIERA Link Menu)

Pause Live TV Pause Live TV programme

Access and pause the live TV programme

You can pause the live TV programme and resume later.

Live TV programme will be recorded on HDD of the connected DIGA Recorder.

- This function is available with DIGA Recorder which has HDD.
- If you connect several recorders including other manufacturers' recorders at the same time, please connect DIGA Recorder which has HDD to the TV's lower HDMI terminal number. For example, if you use HDMI1 and HDMI2 for two recorders, in this case connect DIGA Recorder which has HDD to HDMI1.
- If you cannot operate, check the settings and the equipment
 ➔ "Summary of features", "Connection", "Preparations" (p. 61, 62)



① Display "VIERA Link Menu"

② Select "Pause Live TV" and pause

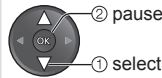
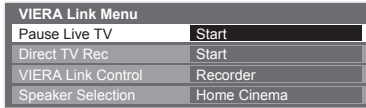

② pause TV picture will be paused.
 ① select

- You can also access Pause Live TV by using VIERA TOOLS. ➔ p. 22
- Live TV programme is recorded on HDD from where it was paused.
- If the paused TV picture disappears after a few minutes
 ➔ OPTION (the paused picture will be restored)

To operate Pause Live TV

- Operations may be different depending on the recorder. In this case, follow the operation guide or read the manual of the recorder.

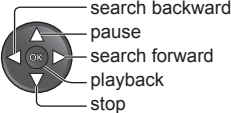

To return to Live TV (stop playback of Pause Live TV / cancel pause)

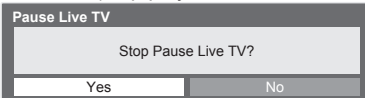

Select "Yes"

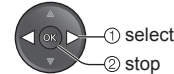

- If you stop playback or cancel pause, the recorded programme will be deleted from HDD.

Direct TV Rec Direct TV Recording - What you see is What you record

Recording the current programme in DIGA Recorder immediately.

- If you connect a variety of recorders including other manufacturers' recorders at the same time, please connect DIGA Recorder to the TV's lower HDMI terminal number. For example, if you use HDMI1 and HDMI2 for two recorders, in this case connect DIGA Recorder to HDMI1.
- If you cannot operate, check the settings and the equipment
 ➔ "Summary of features", "Connection", "Preparations" (p. 61, 62)



① Display "VIERA Link Menu"

② Select "Direct TV Rec" and start recording

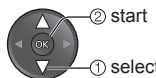
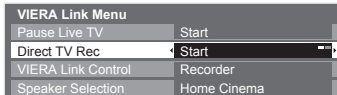

② start

① select

To stop recording

Select "Stop" in "Direct TV Rec" and stop recording

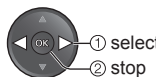
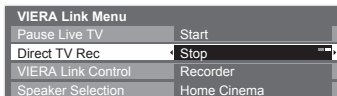

① select

② stop

VIERA Link “HDAVI Control™”

Features available (Using VIERA Link Menu)

VIERA Link Control Operate the connected equipment with VIERA remote control

Access and operate the menu of the equipment

You can control some functions of the connected equipment with this TV remote control by pointing at the TV's signal receiver.

- If you cannot operate, check the settings and the equipment
 - ➔ “Summary of features”, “Connection”, “Preparations” (p. 61, 62)
- For details of the operations of the connected equipment, read the manual of the equipment.

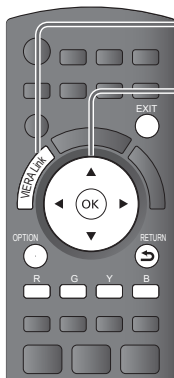

① Display “VIERA Link Menu”

② Select “VIERA Link Control”

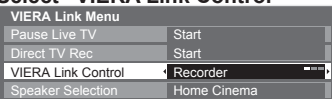

③ Select the equipment you want to access

The type of the connected equipment is displayed. Select the type of the equipment and access.

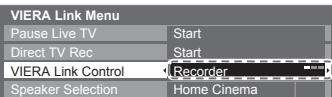

Recorder / Player / Home Cinema / Video Camera / LUMIX / Digital Camera / Other

- You can also access VIERA Link control by using VIERA TOOLS. ➔ p. 22
- The displayed item may vary depending on the connected equipment.
- “Home Cinema” means Player theatre, Blu-ray Disc theatre or Recorder theatre.
- “Other” means Tuner set top box.

The menu of the accessed equipment
(Input mode will be changed automatically)

④ Operate the connected equipment

1. Switch to TV BD/DV, TV

2. Follow the operation guide

- To display the operation guide ➔ Store / set / access ➔
 - Move the cursor / select the menu ➔ Return to the previous menu ➔
 - Move the cursor / access / adjust ➔ Exit the menu ➔
- When the key words are displayed on colour bar ➔

Note

- Some operations may not be available depending on the equipment. If so, use its own remote control.

If multiple recorders or players are connected

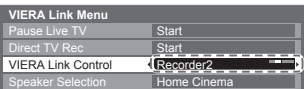

Recorder1-3 /
Player1-3

The number is given from the TV's lower HDMI terminal number connected to the same type equipment. For example, two recorders to HDMI2 and HDMI3, in this case the recorder connected to HDMI2 is displayed as “Recorder1”, and the recorder connected to HDMI3 is displayed as “Recorder2”.

If you access non-VIERA Link equipment

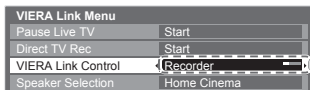

Type of the connected equipment is displayed.

You can access the menu of the equipment. But you cannot operate it. Use its own remote control to operate the equipment.

Features available (Using VIERA Link Menu)

Speaker Selection Speaker control

Access and control the speaker volume

You can control the theatre speaker with this TV remote control by pointing at the TV's signal receiver.

- If you cannot operate, check the settings and the equipment
➔ "Summary of features", "Connection", "Preparations" (p. 61, 62)

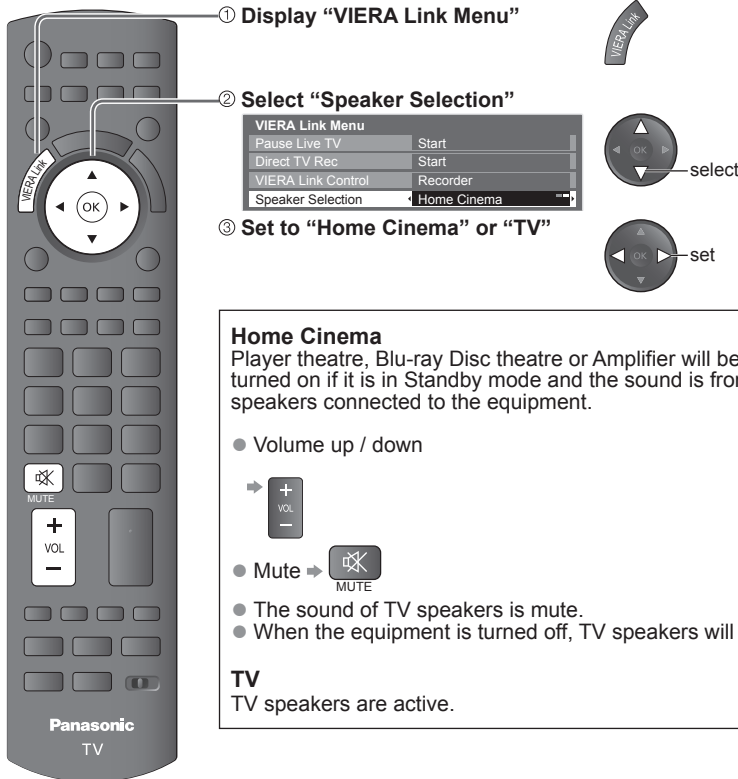



① Display "VIERA Link Menu"

② Select "Speaker Selection"

| VIERA Link Menu | |
|--------------------|-------------|
| Pause Live TV | Start |
| Direct TV Rec | Start |
| VIERA Link Control | Recorder |
| Speaker Selection | Home Cinema |

③ Set to "Home Cinema" or "TV"

Home Cinema
Player theatre, Blu-ray Disc theatre or Amplifier will be automatically turned on if it is in Standby mode and the sound is from theatre speakers connected to the equipment.

- Volume up / down
➔ 
- Mute ➔ 
- The sound of TV speakers is mute.
- When the equipment is turned off, TV speakers will be active.

TV
TV speakers are active.

Note

- If you wish to enjoy the multi-channel sound (e.g. Dolby Digital 5.1ch) via an Amplifier, connect with HDMI cable and Optical digital audio cable (p. 61), and then select "Home Cinema". If your Amplifier has "HDAVI Control 5" function, you can connect only with HDMI cable. In this case, connect your Amplifier to the TV's HDMI2 terminal.
To enjoy the sound from the DIGA Recorder in multi-channel sound, connect an HDMI cable from the DIGA Recorder to the Amplifier (p. 61).

Note

- These functions may not work properly depending on the connected equipment.
- Image or sound may not be available for the first few seconds when input mode is switched.
- Easy playback may be available by using the remote control for Player theatre, Blu-ray Disc theatre or Amplifier. Read the manual of the equipment.
- "HDAVI Control 5" is the newest standard (current as of December, 2009) for HDAVI Control compatible equipment. This standard is compatible with conventional HDAVI equipment.
- To confirm this TV's version of HDAVI Control ➔ "System Information" (p. 29)

External Equipment

These diagrams show our recommendations for how to connect the TV to your various equipment.
For other connections, consult the instructions for each piece of equipment, the table below, and the specifications (p. 79).

PC Computer

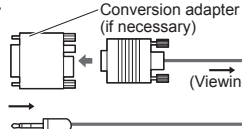

HDMI equipment

→ "HDMI connection" (p. 61, 69)



To listen with speakers

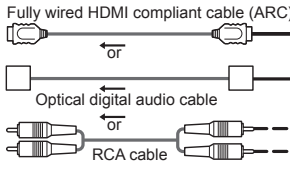
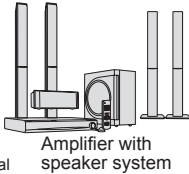

To record / playback

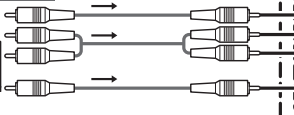
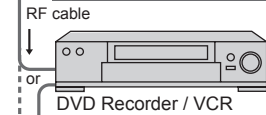

To watch DVDs

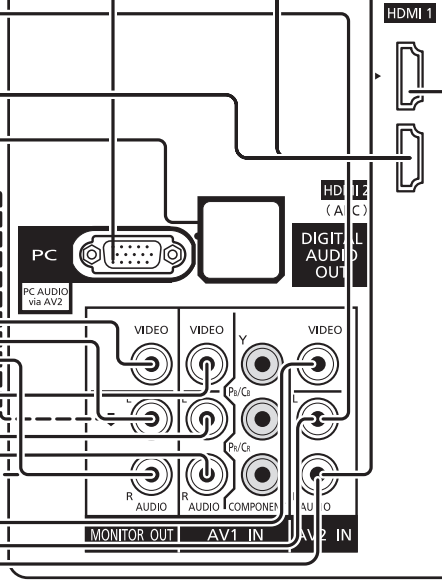
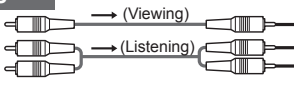

Types of connectable equipment to each terminal

| Recording / Playback (equipment) | Terminal | AV1 IN AV2 IN AV3 IN | MONITOR OUT | DIGITAL AUDIO OUT | ETHERNET |
|---|----------|----------------------------|-------------|-------------------|----------|
| To record / playback videocassettes / DVDs (VCR / DVD recorder) | | ○ | ○ | | |
| To watch DVDs (DVD player) | | ○ | | | |
| To watch camcorder images (Video camera) | | ○ | | | |
| To watch satellite broadcasts (Set top box) | | ○ | | | |
| To play games (Game equipment) | | ○ | | | |
| To use Network services | | | | | ○ |
| To use amplifier with speaker system | | | ○ | ○ | |
| USB HDD Recording | | | | | |
| VIERA Link | | | | | |

○: Recommended Connection
*1: applicable if your amplifier has ARC (Audio Return Channel) function

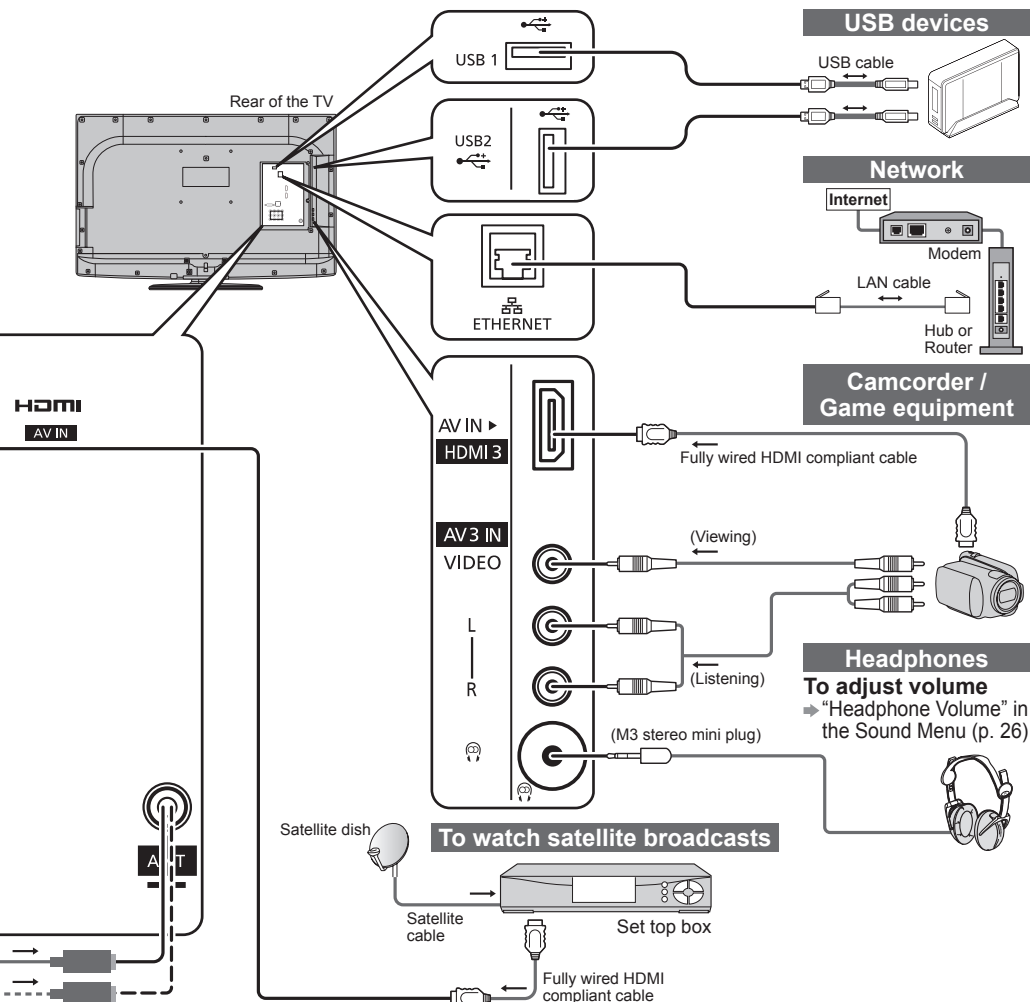

External Equipment

Advanced

| | HDMI | | | USB | |
|--|------|-----|---|-----|---|
| | 1 | 2 | 3 | 1 | 2 |
| | ○ | ○ | ○ | | |
| | ○ | ○ | ○ | | |
| | ○ | ○ | ○ | | |
| | ○ | ○ | ○ | | |
| | | ○*1 | | ○ | ○ |
| | | | | ○ | ○ |
| | ○ | ○ | ○ | | |

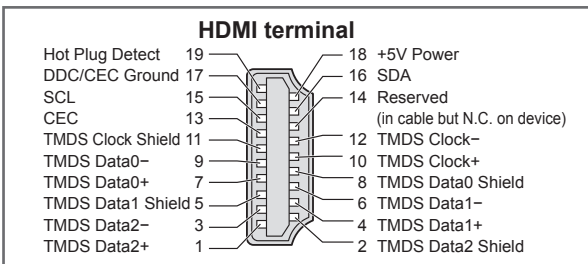

Technical Information

Channel Allocation (Analogue TV mode)

| CH Display / Receive Channel | | | |
|------------------------------|---------------|-------------|---------------|
| CH 0 - CH 5 | S 2 - S 10 | CH 5A | CH 6 - CH 9 |
| CH 9A | CH 10 - CH 12 | S 11 - S 44 | CH 20 - CH 75 |

Rating (Digital TV mode)

| Rating | Meaning | Rating | Meaning |
|----------|-------------------------------|--------|---------------------------|
| No Block | Not classified | M | Mature |
| P | Pre school | MA 15+ | Mature Adult 15+ |
| C | Children | AV 15+ | Adult strong Violence 15+ |
| G | General | R | Restricted 18+ |
| PG | Parental Guidance recommended | | |

Stereo / Bilingual Sound Selection (Analogue TV mode)

⊕/▽ **I/II** When you receive the stereo / bilingual sound system, sound output modes can be selected by pressing the **Stereo / Bilingual Sound Selection** button.

| | | | | |
|----------------|--------|--------|--------|------|
| Audio Signal | STEREO | MAIN I | SUB II | MONO |
| Mode Indicator | ⊕ | I | II | ▽ |

NICAMUsed in New Zealand, Singapore, Hong Kong etc.

| | | | | |
|-------------------|------------------------------------|---------------------------------|--------------|-----------------------------------|
| Type of broadcast | Regular broadcast (Standard Audio) | Regular + NICAM MONO I (MAIN I) | NICAM STEREO | NICAM DUAL MONO (MAIN I / SUB II) |
| Mode Indicator | No Indicator ← ▽ | I ↔ ▽ | ⊕ ↔ ▽ | I ↔ II I ▽ II |

A2 (German)Used in Australia, Malaysia etc.

| | | | |
|-------------------|------------------------------------|---|--------|
| Type of broadcast | Regular broadcast (Standard Audio) | BILINGUAL or DUAL MONO: MAIN I / SUB II | STEREO |
| Mode Indicator | No Indicator ← ▽ | I ↔ II | ⊕ ↔ ▽ |

- If the stereo signal is poor or the receiving conditions are not optimum or if STEREO:MONO automatic switching occurs, it is recommended you switch from STEREO to MONO.
- Even when the contents of the receiving signal undergo changes, selection mode is kept intact.
- When the receiving conditions deteriorate, listening will be easier if the mode is set to the MONO position, using the stereo / bilingual sound selection button.
- DUAL, also known as DUAL MONO or as BILINGUAL is not currently transmitted in some countries.

HDMI connection

HDMI (high-definition multimedia interface) is the world's first complete digital consumer AV interface complying with a non-compression standard.

HDMI allows you to enjoy high-definition digital images and high-quality sound by connecting the TV and the equipment.

HDMI-compatible equipment (*1) with an HDMI or DVI output terminal, such as a DVD player, a set top box or a game equipment, can be connected to the HDMI terminal using an HDMI compliant (fully wired) cable. About connections, see "External Equipment" (p. 66, 67).

Applicable HDMI features

- Input audio signal : 2ch Linear PCM (sampling frequencies - 48 kHz, 44.1 kHz, 32 kHz)
- Input video signal : 480i, 480p, 576i, 576p, 720p, 1080i and 1080p
 - ➔ "Input signal that can be displayed" (p. 70)
 - Match the output setting of the digital equipment.
- Input PC signal : ➔ "Input signal that can be displayed" (p. 70)
 - Match the output setting of the PC.
- VIERA Link (HDAVI Control 5) : ➔ "VIERA Link" (p. 61)
- Audio Return Channel (*2) (HDMI2 terminal only)

DVI connection

If the external equipment has only a DVI output, connect to the HDMI terminal via a DVI to HDMI adaptor cable (*3).

When the DVI to HDMI adaptor cable is used, connect the audio cable to the audio input terminal (HDMI1 / 2: use AV2 audio terminals / HDMI3: use AV3 audio terminals).

If the picture position is not fit to the screen during the DVI connection, adjust the position on "DVI Position Settings" in Setup Menu (p. 27). The settings are memorized for each HDMI terminals and input signals.

Note

- Audio settings can be made on the "HDMI1 / 2 / 3 Input" in the Sound Menu. (p. 27)
- If the connected equipment has an aspect adjustment function, set the aspect ratio to "16:9".
- These HDMI connectors are "type A".
- These HDMI connectors are compatible with HDCP (High-Bandwidth Digital Content Protection) copyright protection.
- An equipment having no digital output terminal may be connected to the input terminal of either "COMPONENT" or "VIDEO" to receive analogue signals.
- This TV incorporates HDMI™ technology.

(*1): The HDMI logo is displayed on HDMI-compliant equipment.

(*2): Audio Return Channel (ARC) is a function to be able to send digital sound signals via an HDMI cable.

(*3): Enquire at your local digital equipment retailer shop.

PC connection

A PC may be connected to this TV so that the PC screen is displayed and sound is heard from the TV.

- PC signals that can be inputted: Horizontal scanning frequency 31 to 69 kHz; vertical scanning frequency 59 to 86 Hz. More than 1,024 signal lines could result in incorrect display of the image.
- A PC adaptor is not necessary for the DOS/IV-compliant D-sub 15-pin connector.

Note

- Some PC models cannot be connected to this TV.
- When using PC, set the colour display quality of PC to the highest position.
- For details of the applicable PC signals, see p. 70.
- Max. display resolution

| Aspect | 4:3 | 1,440 × 1,080 pixels |
|--------|------|----------------------|
| | 16:9 | 1,920 × 1,080 pixels |

- D-sub 15-pin connector signal

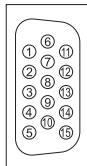

| Pin No. | Signal Name | Pin No. | Signal Name | Pin No. | Signal Name |
|---------|--------------------|---------|--------------------|---------|--------------------|
| ① | R | ⑥ | GND (Ground) | ⑪ | NC (not connected) |
| ② | G | ⑦ | GND (Ground) | ⑫ | NC (not connected) |
| ③ | B | ⑧ | GND (Ground) | ⑬ | HD |
| ④ | NC (not connected) | ⑨ | NC (not connected) | ⑭ | VD |
| ⑤ | GND (Ground) | ⑩ | GND (Ground) | ⑮ | NC (not connected) |

Technical Information

Input signal that can be displayed

COMPONENT (Y, P_B/C_B, P_R/C_R), HDMI

* Mark: Applicable input signal

| Signal name | COMPONENT | HDMI |
|---------------------|-----------|------|
| 525 (480) / 60i | * | * |
| 525 (480) / 60p | * | * |
| 625 (576) / 50i | * | * |
| 625 (576) / 50p | * | * |
| 750 (720) / 60p | * | * |
| 750 (720) / 50p | * | * |
| 1,125 (1,080) / 60i | * | * |
| 1,125 (1,080) / 50i | * | * |
| 1,125 (1,080) / 60p | * | * |
| 1,125 (1,080) / 50p | * | * |
| 1,125 (1,080) / 24p | * | * |

PC (from D-sub 15P)

Applicable input signal for PC is basically compatible to VESA standard timing.

| Signal name | Horizontal frequency (kHz) | Vertical frequency (Hz) |
|----------------------------|----------------------------|-------------------------|
| 640 × 400 @70 Hz | 31.47 | 70.07 |
| 640 × 480 @60 Hz | 31.47 | 59.94 |
| 640 × 480 @75 Hz | 37.50 | 75.00 |
| 800 × 600 @60 Hz | 37.88 | 60.32 |
| 800 × 600 @75 Hz | 46.88 | 75.00 |
| 800 × 600 @85 Hz | 53.67 | 85.06 |
| 852 × 480 @60 Hz | 31.44 | 59.89 |
| 1,024 × 768 @60 Hz | 48.36 | 60.00 |
| 1,024 × 768 @70 Hz | 56.48 | 70.07 |
| 1,024 × 768 @75 Hz | 60.02 | 75.03 |
| 1,024 × 768 @85 Hz | 68.68 | 85.00 |
| 1,280 × 1,024 @60 Hz | 63.98 | 60.02 |
| 1,280 × 768 @60 Hz | 47.70 | 60.00 |
| 1,366 × 768 @60 Hz | 48.39 | 60.04 |
| Macintosh13" (640 × 480) | 35.00 | 66.67 |
| Macintosh16" (832 × 624) | 49.73 | 74.55 |
| Macintosh21" (1,152 × 870) | 68.68 | 75.06 |

PC (from HDMI terminal)

Applicable input signal for PC is basically compatible to HDMI standard timing.

| Signal name | Horizontal frequency (kHz) | Vertical frequency (Hz) |
|---------------------|----------------------------|-------------------------|
| 640 × 480 @60 Hz | 31.47 | 60.00 |
| 750 (720) / 60p | 45.00 | 60.00 |
| 1,125 (1,080) / 60p | 67.50 | 60.00 |

Note

- Signals other than above may not be displayed properly.
- The above signals are reformatted for optimal viewing on your display.
- PC signal is magnified or compressed for display, so that it may not be possible to show fine detail with sufficient clarity.

SD Card

- Use an SD Card which meets SD standards. If not, it may cause the TV to malfunction.
- Do not remove the card while the TV is accessing data (this can damage card or TV).
- Do not touch the pins on the back of the card.
- Do not subject the card to a high pressure or impact.
- Insert the card in the correct direction (otherwise, card may be damaged).
- Electrical interference, static electricity, or erroneous operation may damage the data or card.
- Back up the recorded data at regular intervals in case of deteriorated or damaged data or erratic operation of the TV. (Panasonic is not liable for any deterioration or damage of recorded data.)
- About SD Card format and maximum capacity → p. 44

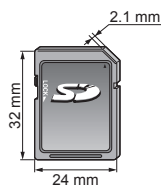

On screen messages

| Message | Meaning / Action |
|---|--|
| Cannot read file | <ul style="list-style-type: none"> ● The file is broken or unreadable. ● The TV does not support the format. (For the applicable formats and data, see above.) |
| Please confirm the SD card is OK | <ul style="list-style-type: none"> ● The inserted SD Card has a problem. |
| No SD card inserted | <ul style="list-style-type: none"> ● Confirm SD Card is inserted correctly. |
| No valid file to play | <ul style="list-style-type: none"> ● The card has no data. |
| This operation is not possible | <ul style="list-style-type: none"> ● Your operation is not available. |

Technical Information

DivX

ABOUT DIVX VIDEO:

DivX® is a digital video format created by DivX, Inc. This is an official DivX Certified device that plays DivX video. Visit www.divx.com for more information and software tools to convert your files into DivX video.

DivX video file

DivX Certified to play DivX video up to HD 1080p, including premium content.

Extension - ".divx" or ".avi"

Image resolution - Up to 1,920 × 1,080 pixels

Video

- Number of stream: Up to 1
- Codec: DIV3, DIV4, DIVX, DX50, DIV6
- FPS (Frame Per Second): Up to 60 fps

Audio

- Number of stream: Up to 8
- Format: MP3, MPEG, AC3
- Multi channel: AC3 is possible. MPEG multi is 2 ch conversion.

- GMC (Global Motion Compensation) is not supported.

Subtitle text file of DivX

Subtitles format - MicroDVD, SubRip, Tmplayer

- The DivX video file and subtitles text file are inside the same folder, and the file names are the same except for the file extensions.
- If there are more than one subtitles text files inside the same folder, they are displayed in the following order of priority: ".srt", ".sub", ".txt".
- To confirm or change the current subtitle status while playing DivX content, press the OPTION button to display Option Menu.
- Depending on the methods used to create the file or the state of recording, only parts of the subtitles may be displayed, or the subtitles may not be displayed at all.

Note

- Depending on how you make SD Card or USB Flash Memory, files and folders may not be displayed in the order you numbered.
- Depending on the software you use to create DivX files, the files may not play.
- Depending on how you create the files and the structure of folders, the files and folders may not be displayed.
- When there are many files and folders, operation may take time to complete or some files may not be displayed or playable.

ABOUT DIVX VIDEO-ON-DEMAND:

This DivX Certified® device must be registered in order to play DivX Video-on-Demand (VOD) content. To generate the registration code, locate the DivX VOD section in the Setup Menu. Go to vod.divx.com with this code to complete the registration process and learn more about DivX VOD.

To show DivX VOD registration code

➔ "DivX® VOD" in the Setup Menu (p. 28)

- If you want to generate the new registration code, you have to deregister the present registration code. After playing DivX VOD content once, the confirmation screen to deregister will be displayed in "DivX® VOD" in the Setup Menu. If you press the OK button on the confirmation screen, the deregistration code will be generated and you will not be able to play any contents that you purchased using the present registration code. You will obtain the new registration code by pressing the OK button on the deregistration code screen.
- If you purchase DivX VOD content using a registration code different from this TV's code, you will not be able to play this content. ("Your device is not authorized to play this DivX protected video." is displayed.)

Regarding DivX content that can only be played a set number of times

Some DivX VOD content can only be played a set number of times.

When you play this content, the remaining number of plays is displayed. You cannot play this content when the number of remaining plays is zero. ("This DivX rental has expired." is displayed.)

Some DivX VOD content can only be played a set number of times.

- When playing this content, the number of remaining plays is reduced by one in the following conditions:
 - If you exit the current application.
 - If you play the other content.
 - If you go to the next or previous content.

Network

On screen messages

| Message | Meaning / Action |
|--|---|
| An internal error occurred. | ● Check the settings. (p. 54 - p. 56) |
| Cannot read file | ● The file is broken or unreadable. Check applicable data format. (p. 72) |
| Communication with the server failed. | ● This might be a problem of the media server. Read the manual of the server software. |
| Connection to the server failed. | ● Check the connections and settings. (p. 53 - 56) |
| Server not found | ● There are no available media server on your home network. Check the connections and settings. (p. 53 - 56) |
| The software update is not completed. | ● Network download failed. Check the connections and settings. (p. 53 - 56) |

USB connection

- It is recommended to connect the USB HDD or USB Flash Memory directly to the TV's USB ports.
- Some USB devices or USB HUB may not be used with this TV.
- You cannot connect any devices by using USB card reader.

The combination of USB devices that have been tested for each TV's USB port.

Combination of USB port 1 + port 2 (and vice versa):

- USB HDD + USB Flash Memory
- USB HDD + Wireless LAN Adaptor
- USB HDD + USB Keyboard
- USB Flash Memory + Wireless LAN Adaptor
- USB Flash Memory + USB Keyboard
- Wireless LAN Adaptor + USB Keyboard

Note

- Additional information for USB devices may be on the following web site. (English only)
<http://panasonic.jp/support/global/cs/tv/>

Maintenance

First, remove the mains plug from the socket outlet.

Display panel, Cabinet, Pedestal

For regular care:

Gently wipe the surface of the display panel, cabinet, or pedestal by using a soft cloth to clean the dirt or fingerprints.

For stubborn dirt:

Dampen a soft cloth with clean water or diluted neutral detergent (1 part detergent to 100 parts water). Then wring the cloth and wipe the surface. Finally, wipe away all the moisture.

Caution

- Do not use a hard cloth or rub the surface too hard. This may cause scratches on the surface.
- Take care not to subject the TV's surfaces to water or detergent. A liquid inside the TV could lead to product failure.
- Take care not to subject the surfaces to insect repellent, solvent, thinner, or other volatile substances. This may degrade surface quality or cause peeling of the paint.
- The surface of the display panel is specially treated and may be easily damaged. Take care not to tap or scratch the surface with your fingernail or other hard objects.
- Do not allow the cabinet and pedestal to make contact with a rubber or PVC substance for a long time. This may degrade surface quality.

Mains plug

Wipe the mains plug with a dry cloth at regular intervals. Moisture and dust may lead to fire or electrical shock.

FAQs

Before requesting service or assistance, please follow these simple guides to resolve the problem. If the problem still persists, please contact your local Panasonic dealer for assistance.

White spots or shadow images (noise)

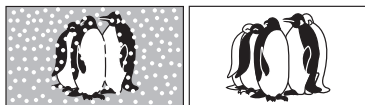

- Check the position, direction, and connection of the aerial.

Neither image nor sound is produced

- Is the TV in "AV mode"?
- Is the mains lead plugged into the socket outlet?
- Is the TV turned On?
- Check Picture Menu (p. 25, 26) and volume.
- Check all required cables and connections are firmly in place.

An error message appears

- Follow the message's instructions.
- If the problem persists, contact your local Panasonic dealer.

The LCD panel moves slightly when it is pushed with a finger Clattered sound might be heard

- There are some looseness around the panel to prevent the damage to the panel.

The panel might move slightly when it is pushed with a finger, and clattered sound might be heard. This is not a malfunction.



There may be red spots, blue spots, green spots and black spots on the screen

- An image on a LCD or Plasma TV screen is created by many small groups of dots known as pixels (which is similar to the image in a newspaper). It also naturally follows that higher panel resolutions contain more pixels. To create a colour image, each pixel consists of three tiny coloured dots (known as sub-pixels), one each of red, green and blue. Each one of these dots is precisely controlled by the electronics of the TV to produce the picture. Whilst Panasonic maintains the highest standards in manufacturing technology and processes in the construction of these panels, there are a number of allowable pixel/sub-pixel failures that still allow the panel to be defined as a good panel. It is not possible to guarantee absolutely no pixel loss.

| | Problem | Actions |
|--------|---|--|
| Screen | Chaotic image, noisy | <ul style="list-style-type: none"> ● Change the setting of "P-NR" in the Picture Menu (to remove noise). (p. 26) ● Check nearby electrical products (car, motorcycle, fluorescent lamp). |
| | No image can be displayed | <ul style="list-style-type: none"> ● Is "Colour" or "Contrast" in the Picture Menu set to the minimum? (p. 25) |
| | Blurry or distorted image (no sound or low volume) | <ul style="list-style-type: none"> ● Reset channels (p. 32, 33). |
| | Unusual image is displayed | <ul style="list-style-type: none"> ● Turn off the TV with Mains power On / Off switch, then turn it on again. |
| | "Shop" appears on screen at switch on | <ul style="list-style-type: none"> ● "Shop" was selected in "Auto Tuning" (p. 12) ● Reset settings in "Shipping Condition" (p. 38), then select "Home" in "Auto Tuning" (p. 12) |
| Sound | No sound is produced | <ul style="list-style-type: none"> ● Is "Sound Mute" active? (p. 10) ● Is the volume set to the minimum? |
| | Sound level is low or sound is distorted | <ul style="list-style-type: none"> ● Sound signal reception may be deteriorated. ● Set "MPX" in the Sound Menu to "Mono" (p. 27). |

FAQs

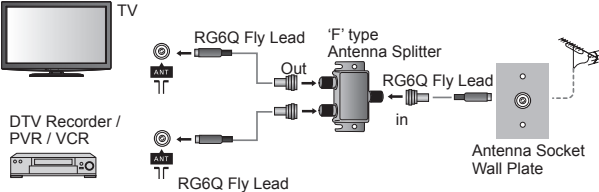
| | Problem | Actions |
|------------|--|---|
| HDMI | Sound is unusual | <ul style="list-style-type: none"> ● Set the sound setting of the connected equipment to "2ch L.PCM". ● Check the "HDMI1 / 2 / 3 Input" setting in the Sound Menu. (p. 27) ● If digital sound connection has a problem, select analogue sound connection. (p. 69) |
| | Pictures from external equipment are unusual when the equipment is connected via HDMI | <ul style="list-style-type: none"> ● Is the HDMI cable connected properly? (p. 61, 66, 67) ● Turn Off the TV and equipment, then turn them On again. ● Check an input signal from the equipment. (p. 70) ● Use an equipment compliant with EIA/CEA-861/861B. |
| Network | Cannot connect to the network | <ul style="list-style-type: none"> ● Check the LAN cable is connected properly. (p. 53) ● Check the connections and settings. (p. 53 - 56) ● Check the network equipment and network environment. ● If the problem persists, consult your Internet Service Provider or telecommunications company. |
| | Cannot select the file during DLNA operations | <ul style="list-style-type: none"> ● Is media server prepared? (p. 52) ● Check applicable data format. (p. 52) |
| | Cannot operate VIERA CAST | <ul style="list-style-type: none"> ● Check the connections and settings. (p. 53 - 56) ● The server or connected line might be busy now. |
| Digital TV | <p>Note: Digital TV reception is only as good as the antenna and the antenna cabling delivering the DTV signals to the television. Reliable digital TV reception requires high quality, robust DTV signals which can only be achieved when using a TV antenna and cabling designed for digital TV reception.</p> <ul style="list-style-type: none"> ● Further reading please visit: http://www.digitalready.gov.au/publications.aspx where you can download 'The Digital TV Antenna Systems for Homes Handbook' information pdf file. ● For your safety, the antenna and cabling should be inspected / installed by a licenced installer that should comply with Australian Standard AS1417.1 for Domestic installations or AS1367 for MATV installations. | |
| | Connecting devices such as DTV recorder / PVR / VCR etc that also require an antenna connection to the digital television | <ul style="list-style-type: none"> ● To maintain optimum antenna signal quality, use an 'F' type TV signal splitter (as illustrated) when connecting two or more devices to the same antenna socket.  <ul style="list-style-type: none"> ● Hint: Some degradation of the DTV signal may occur if you are connecting the aerial through an external device (e.g. DVD Recorder or Set Top Box). In this case it is better to use a splitter and connect the aerial directly to both devices. |
| | After digital TV tuning, (or re-tuning) some or all DTV channels are missing | <ul style="list-style-type: none"> ● Check to ensure your area is covered by DTV transmissions. ● Check that the aerial and antenna cable are designed for DTV reception. If you live within 5-10 Km of DTV transmission towers, a combined VHF / UHF Digital TV aerial should be adequate. Outside this area, separate VHF and UHF aerials provide superior reception performance. ● If you live in a unit or apartment, check to ensure the Master Antenna TV (MATV) system is designed for analogue and DTV reception. Please consult your body corporate. |

| | Problem | Actions |
|------------|--|--|
| Digital TV | Picture regularly pixelates on some channels, or 'No Signal' message | <ul style="list-style-type: none"> ● Check "Signal Condition" via TV Setup menu. If "Signal Quality" or "Signal Strength" are red/orange or constantly changing, check aerial/cable/connections. If problem persists consult your local TV antenna installer. ● Too much signal; is "Signal Strength" always at full strength? If yes, try attenuating (reducing) the signal strength ● Check that the aerial and antenna cable are designed for DTV reception. ● The received signal may be too weak to allow the TV to reliably lock to the selected channel to generate a viewable picture. If problem persists consult your local TV aerial installer. ● Interference from household appliances (known as impulse noise) such as light switches, fridges etc may cause picture break up and / or audio distortion. Use high quality quad shielded coaxial cable (RG6Q) fly lead between TV and antenna wall socket to minimise impulse noise pickup. If problem persists consult your local TV aerial installer. ● Antenna installation may be using an aerial amplifier that is faulty or an older style aerial amplifier that was not designed for digital TV. ● Older style antenna cabling, loose fitting/corroded wall socket connections/terminals etc. |
| | Picture infrequently pixelates on some or all channels | <ul style="list-style-type: none"> ● Electrical interference caused by local or distant lighting storms, heavy rain, high wind etc may cause picture to break up and or audio to mute/distort momentarily. ● Impulse noise interference from an infrequently used electrical appliance, or a passing vehicle or lawn mower with a "noisy" ignition system. ● Older style antenna cabling, loose fitting/corroded wall socket connections/terminals etc. |
| Other | TV goes into Standby mode | <ul style="list-style-type: none"> ● Auto power standby function is activated. ● The TV enters Standby mode about 30 mins. after analogue broadcasting ends. |
| | The remote control does not work or is intermittent | <ul style="list-style-type: none"> ● Are the batteries installed correctly? (p. 3) ● Has the TV been switched On? ● Point the remote control directly at the front of the TV (within about 7 m and a 30 degree angle of the front of the TV). ● Situate the TV away from sunshine or other sources of bright light not to shine on the TV's remote control signal receiver. |

Licence

Even if no special notation has been made of company or product trademarks, these trademarks have been fully respected.

- VGA is a trademark of International Business Machines Corporation.
- S-VGA is a registered trademark of the Video Electronics Standard Association.
- SDXC Logo is a trademark of SD-3C, LLC.
- HDMI, the HDMI Logo and High-Definition Multimedia Interface are trademarks or registered trademarks of HDMI Licensing LLC in the United States and other countries.
- HDAVI Control™ is a trademark of Panasonic Corporation.
- “AVCHD” and the “AVCHD” logo are trademarks of Panasonic Corporation and Sony Corporation.
- Manufactured under license from Dolby Laboratories.
Dolby and the double-D symbol are trademarks of Dolby Laboratories.
- Macintosh is a trademark of Apple Inc.
- VIERA CAST™ is a trademark of Panasonic Corporation.
- DLNA®, the DLNA Logo and DLNA CERTIFIED™ are trademarks, service marks, or certification marks of the Digital Living Network Alliance.
- Windows is a registered trademark of Microsoft Corporation in the United States and/or other countries.
- DivX® is a registered trademark of DivX, Inc., and is used under license.
- YouTube and Picasa are trademarks of Google, Inc.

Specifications

| | | TH-L32D25A | TH-L37D25A | TH-L42D25A | |
|-------------------------------|--|--|---|--|--|
| Power | Power rating | AC 220 - 240 V, 50 / 60 Hz 0.59A | AC 220 - 240 V, 50 / 60 Hz 0.70 A | AC 220 - 240 V, 50 / 60 Hz 0.73 A | |
| | Normal (Home) mode | 62 W | 81 W | 90 W | |
| | Standby condition | 0.30 W | 0.30 W | 0.30 W | |
| Display panel | Aspect Ratio | 16:9 | | | |
| | Visible screen size | 80 cm (diagonal) 698 mm (W) × 393 mm (H) | 94 cm (diagonal) 819 mm (W) × 460 mm (H) | 106 cm (diagonal) 930 mm (W) × 523 mm (H) | |
| | Number of pixels | 2,073,600 (1,920 (W) × 1,080 (H)) [5,760 × 1,080 dots] | | | |
| Sound | Speaker | 140 mm × 35 mm × 2 pcs, 8 Ω | | | |
| | Audio Output | 20 W (10 W + 10 W), 10% THD | | | |
| | Headphones | M3 (3.5 mm) stereo mini Jack × 1 | | | |
| PC signals | VGA, SVGA, WVGA, XGA SXGA, WXGA (compressed) Horizontal scanning frequency 31 - 69 kHz Vertical scanning frequency 59 - 86 Hz | | | | |
| Receiving Systems / Band name | PAL B/G | Reception of Off air broadcasts | | | |
| | DVB-T | 7 MHz VHF / UHF (Australia) free-to-air TV broadcast reception | | | |
| | PAL 60 Hz M. NTSC NTSC | Playback of NTSC tape from some PAL Video recorders (VCR) Playback from M. NTSC Video recorders (VCR) Playback from NTSC Video recorders (VCR) | | | |
| Aerial - Rear | Standard Belling & Lee connector | | | | |
| Operating Conditions | Temperature : 0 °C - 35 °C Humidity : 20 % - 80 % RH (non-condensing) | | | | |
| Connection Terminals | AV1 Input | AUDIO L - R | RCA PIN Type × 2 | 0.5 V[rms] | |
| | | VIDEO | RCA PIN Type × 1 | 1.0 V[p-p] (75 Ω) | |
| | | COMPONENT | Y Pb/Cb, Pr/Cr | 1.0 V[p-p] (including synchronization) ±0.35 V[p-p] | |
| | AV2 Input | AUDIO L - R | RCA PIN Type × 2 | 0.5 V[rms] | |
| | | VIDEO | RCA PIN Type × 1 | 1.0 V[p-p] (75 Ω) | |
| | AV3 Input | AUDIO L - R | RCA PIN Type × 2 | 0.5 V[rms] | |
| | | VIDEO | RCA PIN Type × 1 | 1.0 V[p-p] (75 Ω) | |
| | Monitor Output | AUDIO L - R | RCA PIN Type × 2 | 0.5 V[rms] (high impedance) | |
| | | VIDEO | RCA PIN Type × 1 | 1.0 V[p-p] (75 Ω) | |
| | Others | HDMI1 - 3 Input | TYPE A Connectors | ● This TV supports "HDAVI control 5" function. | |
| | | PC Input | HIGH-DENSITY D-SUB 15PIN | R / G / B: 0.7 V[p-p] (75 Ω) HD / VD: TTL Level 2.0 - 5.0 V[p-p] (high impedance) | |
| | | DIGITAL AUDIO OUT | PCM / Dolby Digital, Fiber optic | | |
| | | Card slot | SD Card slot × 1 | | |
| | | USB 1/2 | USB 2.0 Type A connector | DC 5V, Max 500 mA | |
| | ETHERNET | 10BASE-T / 100BASE-TX | | | |
| Dimensions (W × H × D) | 795 mm × 564 mm × 217 mm (With Pedestal) 795 mm × 521 mm × 77 mm (TV only) | 917 mm × 632 mm × 287 mm (With Pedestal) 917 mm × 590 mm × 77 mm (TV only) | 1,032 mm × 697 mm × 329 mm (With Pedestal) 1,032 mm × 655 mm × 77 mm (TV only) | | |
| Mass | 14.0 kg Net (With Pedestal) 12.0 kg Net (TV only) | 17.5 kg Net (With Pedestal) 14.5 kg Net (TV only) | 21.5 kg Net (With Pedestal) 18.5 kg Net (TV only) | | |

Note

- Design and Specifications are subject to change without notice. Mass and Dimensions shown are approximate.

Panasonic Warranty

1. The product is warranted for 12 months from the date of purchase. Subject to the conditions of this warranty Panasonic or its Authorised Service Centre will perform necessary service on the product without charge for parts or labour if, in the opinion of Panasonic, the product is found to be faulty within the warranty period.
2. This warranty only applies to Panasonic products purchased in Australia and sold by Panasonic Australia or its Authorised Distributors or Dealers and only where the products are used and serviced within Australia or its territories. Warranty cover only applies to service carried out by a Panasonic Authorised Service Centre and only if valid proof of purchase is presented when warranty service is requested.
3. This warranty only applies if the product has been installed and used in accordance with the manufacturer's recommendations (as noted in the operating instructions) under normal use and reasonable care (in the opinion of Panasonic). The warranty covers normal domestic use only and does not cover damage, malfunction or failure resulting from use of incorrect voltages, incorrect installation, accident, misuse, neglect, build-up of dirt or dust, abuse, maladjustment of customer controls, mains supply problems, thunderstorm activity, infestation by insects or vermin, tampering or repair by unauthorised persons (including unauthorised alterations), introduction of sand, humidity or liquids, commercial use such as hotel, office, restaurant, or other business or rental use of the product, exposure to abnormally corrosive conditions or any foreign object or matter having entered the product.
4. This warranty does not cover the following items unless the fault or defect existed at the time of purchase:
 - (a) Cabinet Part(s)
 - (b) Video or Audio Tapes
 - (c) SD cards or USB devices
 - (d) User replaceable Batteries
 - (e) DVD Video, Blu-ray, or Recordable Discs
 - (f) Video / Audio Heads from wear and tear in normal use
 - (g) Information stored on Hard Disk Drive, USB stick or SD card
 - (h) DTV reception issues caused by TV Aerial / Cabling / Wall socket(s) etc
5. Some products may be supplied with Ethernet connection hardware. The warranty is limited on such products and will not cover
 - (a) Internet and or DLNA connection / setup related problems
 - (b) Access fees and or charges incurred for internet connection
 - (c) The use of incompatible software or software not specifically stipulated in the product operations manual; and
 - (d) Any indirect or consequential costs associated with the incorrect use or misuse of the hardware, its connection to the internet or any other device.
6. If warranty service is required you should:
 - Telephone Panasonic's Customer Care Centre on 132600 or visit our website and use the Service Centre Locator for the name/address of the nearest Authorised Service Centre.
 - Send or bring the product to a Panasonic Authorised Service Centre together with your proof of purchase receipt as a proof of purchase date. Please note that freight and insurance to and / or from your nearest Authorised Service Centre must be arranged by you.
7. The warranties hereby conferred do not extend to, and exclude, any costs associated with the installation, de-installation or re-installation of a product, including costs related to the mounting, de-mounting or remounting of any screen, (and any other ancillary activities), delivery, handling, freight, transportation or insurance of the product or any part thereof or replacement of and do not extend to, and exclude, any damage or loss occurring by reason of, during, associated with, or related to such installation, de-installation, re-installation or transit.

Panasonic Authorised Service Centres are located in major metropolitan areas and most regional centres of Australia, however, coverage will vary dependant on product. For advice on exact Authorised Service Centre locations for your product, please telephone our Customer Care Centre on 132600 or visit our website and use the Service Centre Locator.

Unless otherwise specified to the consumer the benefits conferred by this express warranty are additional to all other conditions, warranties, guarantees, rights and remedies expressed or implied by the Trade Practices Act 1974 and similar consumer protection provisions contained in legislation of the States and Territories and all other obligations and liabilities on the part of the manufacturer or supplier and nothing contained herein shall restrict or modify such rights, remedies, obligations or liabilities. **Feb 2010**

THIS WARRANTY CARD AND THE PURCHASE DOCKET (OR SIMILAR PROOF OF PURCHASE) SHOULD BE RETAINED BY THE CUSTOMER AT ALL TIMES

If you require assistance regarding warranty conditions or any other enquiries,
please contact our Customer Care Centre via the Panasonic website www.panasonic.com.au or
by phone on 132 600. If phoning in, please ensure you have your operating instructions available.

Panasonic Australia Pty. Limited
ACN 001 592 187 ABN 83 001 592 187
Locked Bag 505, Frenchs Forest, NSW 2086

PRO-031-F11 Issue: 2.0

18-02-2010

RQA0245

Customer's Record

The model number and serial number of this product may be found on its rear panel. You should note the model number and the serial number in the space provided below and retain this book, plus your purchase receipt, as a permanent record of your purchase to aid in identification in the event of theft or loss, and for Warranty Service purposes.

Model Number

Serial Number

Panasonic Corporation

Web Site: <http://panasonic.net>

© Panasonic Corporation 2010

Printed in Malaysia
M0310-1030