

# Panasonic®

## Operating Instructions LCD TV

Model No. **TH-L37V10A**

# VIERA

**DVB**®

**AVCHD**™

**VIERA**  
Link

**DOLBY**  
DIGITAL

**VIERA**  
IMAGE VIEWER

**FULL**  
**HD**  
1920×1080p

**SD**  
**HG**™

**HD**TV

**HDMI**™  
HIGH-DEFINITION MULTIMEDIA INTERFACE

Thank you for purchasing this Panasonic product.  
Please read these instructions before operating your set and retain them for future reference.  
The images shown in this manual are for illustrative purposes only.

English

SA  
TQB4GC0268(A)

Turn your own living room into a movie theatre!

# Experience an amazing level of multi-

Receive digital terrestrial services using an integrated Digital TV tuner  
Sharp pictures with HDMI terminal  
Create home theatre and DVD recorder link-ups with "VIERA Link"  
without complicated settings!

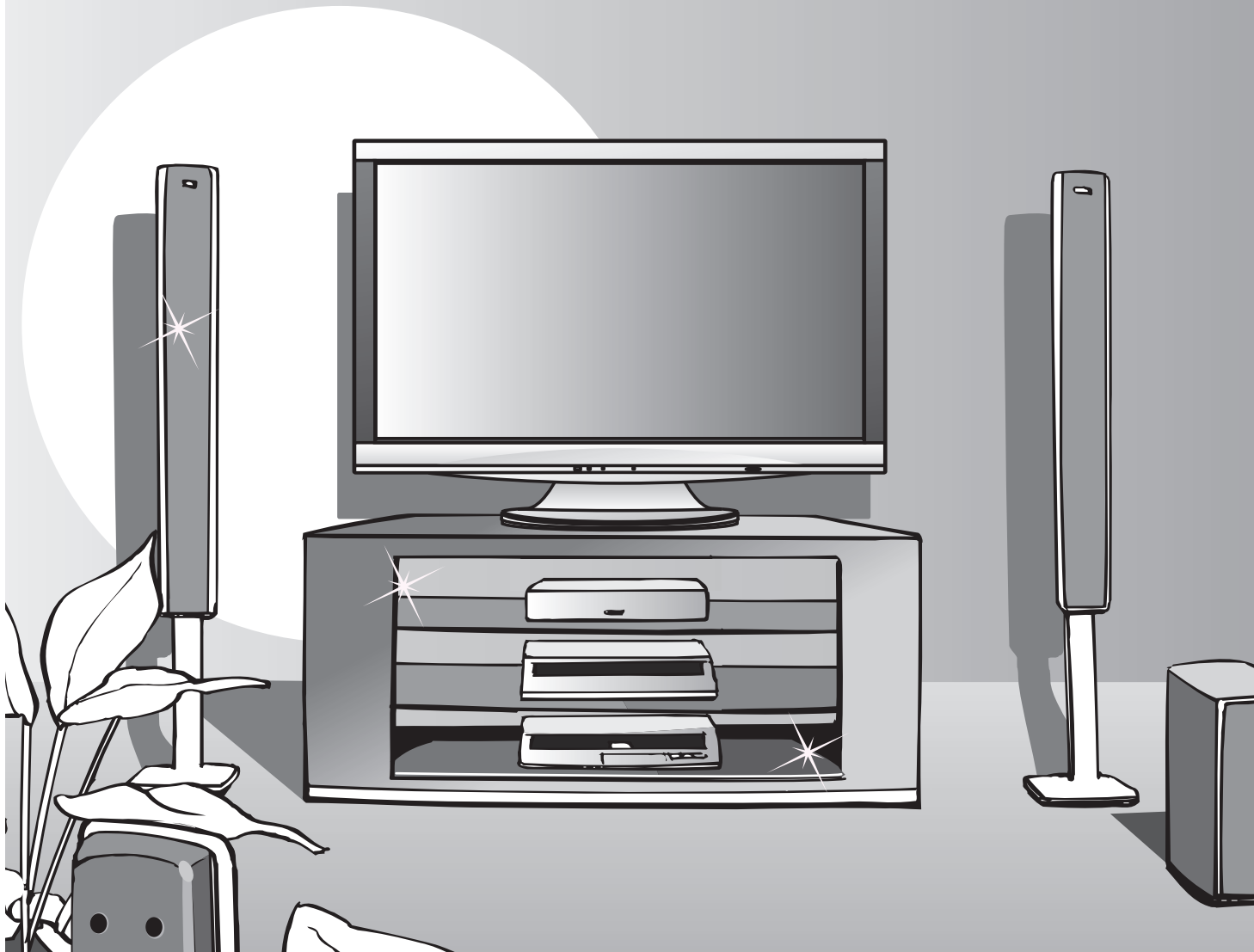

**DVB**<sup>®</sup>  
Digital Video  
Broadcasting

Trade Mark of the DVB Digital Video Broadcasting Project (1991 to 1996)  
TH-L37V10A Declaration of Conformity No. 6358, 7 January 2009

## Notice about Digital TV Functions

- The MPEG-4 AVC feature was designed to specifications as we know them today. This specification may be subject to future changes beyond our control that may not guarantee the decoding of such services.

February 2009

# media excitement

# Contents

## Enjoy rich multimedia

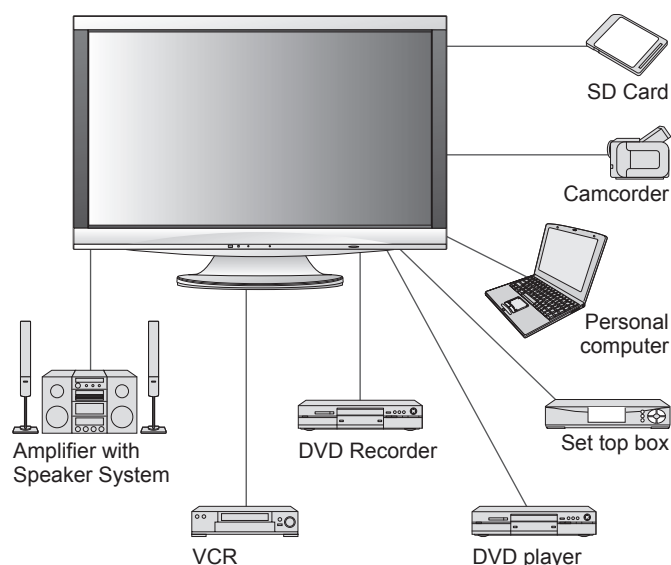

## Be Sure to Read

- Safety Precautions ..... 4  
(Warning / Important Installation Notices)
- Maintenance ..... 6
- Licence ..... 6

## Quick Start Guide

- Accessories / Options ..... 7
- Identifying Controls ..... 8
- Basic Connection ..... 10
- Auto Tuning ..... 11

## Basic Features

- Watching TV ..... 13
- Using TV Guide ..... 17
- Viewing Teletext ..... 18
- Watching Videos and DVDs ..... 20

## Advanced Features

- How to Use Menu Functions ..... 22  
(picture, sound quality, etc.)
- Input Labels ..... 26
- Digital TV Settings ..... 27
- Editing Channels ..... 28
- Tuning Channels ..... 30
- Restore Settings (Shipping Condition) ..... 32
- Displaying PC Screen on TV ..... 33
- HDMI Functions ..... 34
- Viewing from SD Card  
(VIERA IMAGE VIEWER) ..... 35
- VIERA Link "HDAVI Control™" ..... 38
- VIERA Tools ..... 43
- External Equipment ..... 44

## Technical Features

- Technical Information ..... 46
- FAQs ..... 49
- Specifications ..... 51
- WARRANTY ..... 52

Quick Start Guide

Basic

Advanced

Technical

# Safety Precautions

## Warning

### Handling the mains plug and lead

- Insert the mains plug fully into the socket outlet. If the mains plug is loose, it could generate heat and cause fire.
- Ensure that the mains plug is easily accessible.
- Do not touch the mains plug with a wet hand. This may cause electrical shock.
- Do not damage the mains lead. A damaged lead may cause fire or electrical shock.
  - Do not move the TV with the lead plugged in the socket outlet.
  - Do not place a heavy object on the lead or place the lead near a high-temperature object.
  - Do not twist the lead, bend it excessively, or stretch it.
  - Do not pull on the lead. Hold onto the mains plug body when disconnecting lead.
  - Do not use a damaged mains plug or socket outlet.

If you find any abnormality, remove the mains plug immediately!

AC 220 - 240 V  
50 / 60 Hz

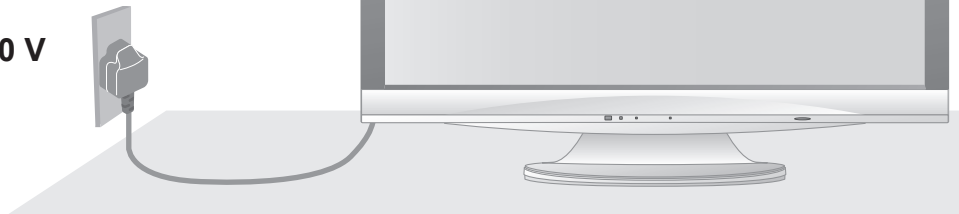

### Power source

- This TV is designed to operate on AC 220 - 240 V, 50 / 60 Hz.

### Do not remove covers NEVER modify the TV yourself

High-voltage components may cause serious electrical shock.

- Have the TV checked, adjusted, or repaired at your local Panasonic dealer.

### Keep liquids away from the TV

- To prevent damage which may result in fire or shock hazard, do not expose this appliance to dripping or splashing.
- Do not place containers with water (flower vase, cups, cosmetics, etc.) above the TV, including on shelves above, etc.

### Do not expose to direct sunlight and other sources of heat

- Avoid exposing the TV to direct sunlight and other sources of heat. To prevent fire never place any type of candle or naked flame on top or near the TV.

### Avoid exposing the TV to high atmospheric moisture (such as tropical rain) or night time dew condensation

- This TV is designed and manufactured for indoor use only.

### Do not place foreign objects inside the TV

- Do not allow any objects to drop into the TV through the air vents. Fire or electrical shock may result.

### Do not place the TV on sloped or unstable surfaces

- The TV may fall off or tip over.

### Use only the dedicated pedestals / mounting equipment

- Using an unapproved pedestal or other fixtures may make the TV unstable, risking injury. Be sure to ask your local Panasonic dealer to perform setup.
- Use approved pedestals / mounts (p. 7).

### Do not allow children to handle SD Card

- As with any small object, SD Cards can be swallowed by young children. Please remove SD Card immediately after use and store out of reach of children.

## Important Installation Notices

### Install TV on a stable surface

If a television is not positioned in a sufficiently stable location, it can be potentially hazardous due to falling. Many injuries, particularly to children, can be avoided by taking simple precautions such as:

- Using cabinets or stands recommended by the manufacturer of the television.
- Only using furniture that can safely support the television.
- Ensuring the television is not overhanging the edge of the supporting furniture.
- Not placing the television on tall furniture (for example, cupboards or bookcases) without anchoring both the furniture and the television to a suitable support.
- Not standing the televisions on cloth or other materials placed between the television and supporting furniture.
- Educating children about the dangers of climbing on furniture to reach the television or its controls.

### When cleaning the TV, remove the mains plug

- Cleaning an energized TV may cause electrical shock.

### When the TV is not going to be used for a long period of time, remove the mains plug

- This TV will still consume some power even in the Off mode, as long as the mains plug is still connected to a live socket outlet.

### Transport only in upright position

### Allow sufficient space around the TV for radiated heat

Minimum distance

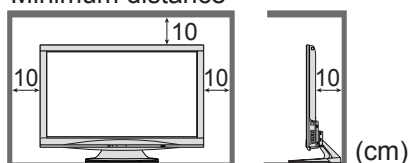

- When using the pedestal, keep the space between the bottom of the TV and the surface where the TV is set.
- In case of using Wall-hanging bracket, follow the manual of it.

### Do not block the rear air vents

- Blocked ventilation by newspapers, table cloths, curtains, etc. may cause overheating, fire or electrical shock.

### Do not expose your ears to excessive volume from the headphones

- Irreversible damage can be caused.

### Auto power standby function

- If no signal is received and no operation is performed in Analogue TV mode for 30 minutes, the TV will automatically go to standby mode.

### Keep the TV away from these types of equipment

- Electronic equipment

In particular, do not place video equipment near the TV. Electromagnetic interference may distort images / sound.

- Equipment with an infrared sensor

This TV also emits infrared rays. This may affect operation of other equipment.

### Adjust the LCD panel to your desired angle

- Ensure that the pedestal does not hang over the edge of the base even if the TV swivels to the full rotation range.
- Do not place any objects or hands within the full rotation range.

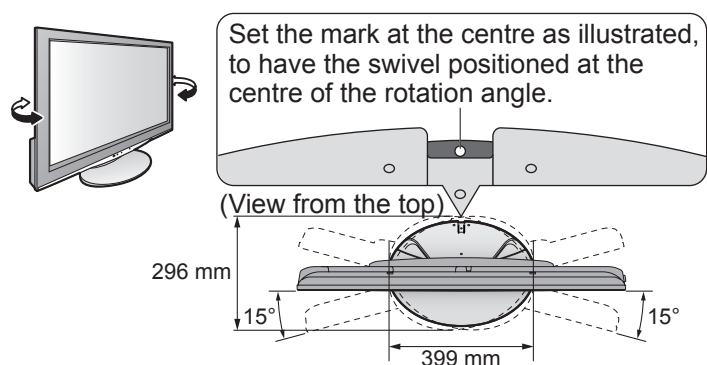

# Maintenance

**First, remove the mains plug from the socket outlet.**

## Display panel

Regular care: Gently wipe the surface clean of dirt by using a soft cloth.

Major contamination: Wipe the surface clean using a soft cloth dampened with clean water or diluted neutral detergent (1 part detergent to 100 parts water). Then, using a soft dry cloth, evenly wipe the surface clean until it is dry.

### Caution

- The surface of the display panel has been specially treated and may be easily damaged. Do not tap or scratch the surface with your fingernail or other hard object.
- Take care not to subject the surface to insect repellent, solvent, thinner, or other volatile substances. This may degrade surface quality.

## Cabinet, Pedestal

Regular care: Wipe the surface clean using a soft dry cloth.

Major contamination: Dampen a soft cloth with clean water or water containing a small amount of neutral detergent. Then, wring the cloth and wipe the surface clean with it. Finally, wipe the surface clean with a dry cloth.

### Caution

- Take care not to subject the TV's surfaces to detergent. A liquid inside the TV could lead to product failure.
- Take care not to subject surfaces to insect repellent, solvent, thinner, or other volatile substances. This may deteriorate the surface by peeling the paint.
- Do not allow the cabinet and pedestal to make contact with a rubber or PVC substance for a long time.

## Mains plug

Wipe the mains plug with a dry cloth at regular intervals. Moisture and dust may lead to fire or electrical shock.

# Licence

- DVB is a trademark of the DVB Digital Video Broadcasting Project (1991 to 1996).
- VGA is a trademark of International Business Machines Corporation.
- S-VGA is a registered trademark of the Video Electronics Standard Association.
- SDHC Logo is a trademark.
- HDMI, the HDMI Logo and High-Definition Multimedia Interface are trademarks or registered trademarks of HDMI Licensing LLC.
- HDAVI Control™ is a trademark of Panasonic Corporation.
- "AVCHD" and the "AVCHD" logo are trademarks of Panasonic Corporation and Sony Corporation.
- Manufactured under license from Dolby Laboratories.  
Dolby and the double-D symbol are trademarks of Dolby Laboratories.
- Macintosh is a trademark of Apple Inc.

Even if no special notation has been made of company or product trademarks, these trademarks have been fully respected.

This product is licensed under the AVC patent portfolio license for the personal and non-commercial use of a consumer to (i) encode video in compliance with the AVC Standard ("AVC Video") and/or (ii) decode AVC Video that was encoded by a consumer engaged in a personal and non-commercial activity and/or was obtained from a video provider licensed to provide AVC Video. No license is granted or shall be implied for any other use. Additional information may be obtained from MPEG LA, LLC. See <http://www.mpegla.com>.

# Accessories / Options

## Standard accessories

Check that you have the accessories and items shown

- Remote Control
  - N2QAYB000372



- Batteries for the Remote Control (2)
  - R6 (AA)



- Cleaning cloth



- Operating Instructions with Warranty statement

- Ferrite core
  - ➔ p. 10

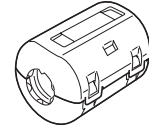

- Fall-prevention parts
  - ➔ p. 8

### Caution

This product contains possibly dangerous parts (such as plastic bags), that can be breathed in or swallowed by young children accidentally. Keep these parts out of reach of young children.

## Optional accessories

Please contact your nearest Panasonic dealer to purchase the recommended wall-hanging bracket. For additional details, please refer to the wall-hanging bracket installation manual.

Wall-hanging bracket  
● TY-WK3L1RW

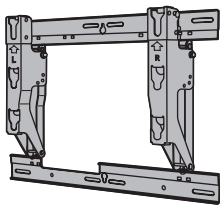

Rear of the TV

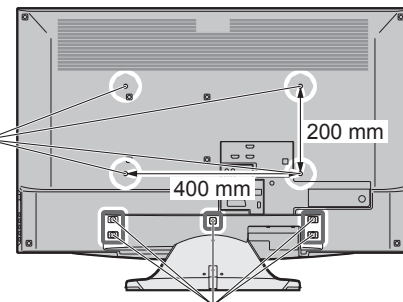

Holes for wall-hanging bracket installation

**To remove the Pedestal**  
Remove five screws.

### WARNING!

- Failure to use a Panasonic bracket or choosing to mount the TV yourself will be done at the risk of the consumer. Any damage resulting from not having a professional installer mount your TV will void your warranty.
- Always be sure to ask a qualified technician to carry out set-up. Incorrect fitting may cause equipment to fall, resulting in injury and product damage.
- Do not mount the TV directly below ceiling lights (such as spotlights, floodlights or halogen lights) which typically give off high heat. Doing so may warp or damage plastic cabinet parts.
- Take care when fixing wall brackets to the wall. Always ensure that there are no electrical cables or pipes in the wall before hanging bracket.
- To prevent fall and injury, remove the TV from its fixed wall position when it is no longer in use.

## Installing remote's batteries

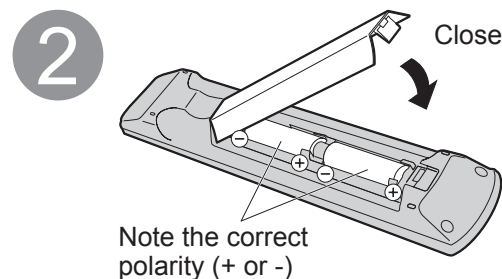
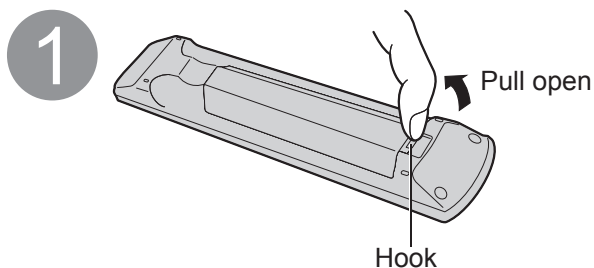

### Caution

- Incorrect installation may cause battery leakage and corrosion, resulting in damage to the remote control.
  - Do not mix old and new batteries.
  - Do not mix different battery types (such as alkaline and manganese batteries).
  - Do not use rechargeable (Ni-Cd) batteries.
  - Do not burn or breakup batteries.
- Batteries must not be exposed to excessive heat such as sunshine, fire or the like.

# Accessories / Options

## Preventing the TV from falling over

This TV could fall over if it's pushed, pulled or knocked down.

We therefore recommend the TV is secured to the base as illustrated.

- This measure is designed to reduce the risk of injury from a falling TV. However, it cannot guarantee protection in all cases.

### Fall-prevention parts

- Ⓐ Band  
● TKLA4401

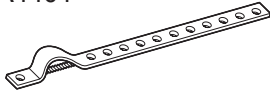

- Ⓑ Screw



- Ⓒ Wood screw

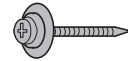

### Securing to a base

Fix pedestal and base together with band.

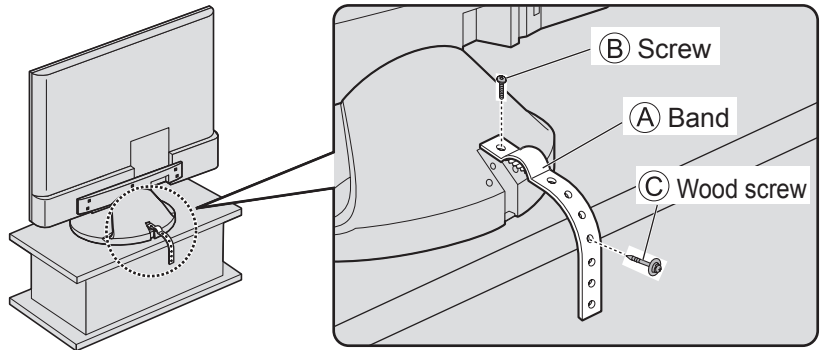

This image is for illustrative purposes only.

# Identifying Controls

## TV

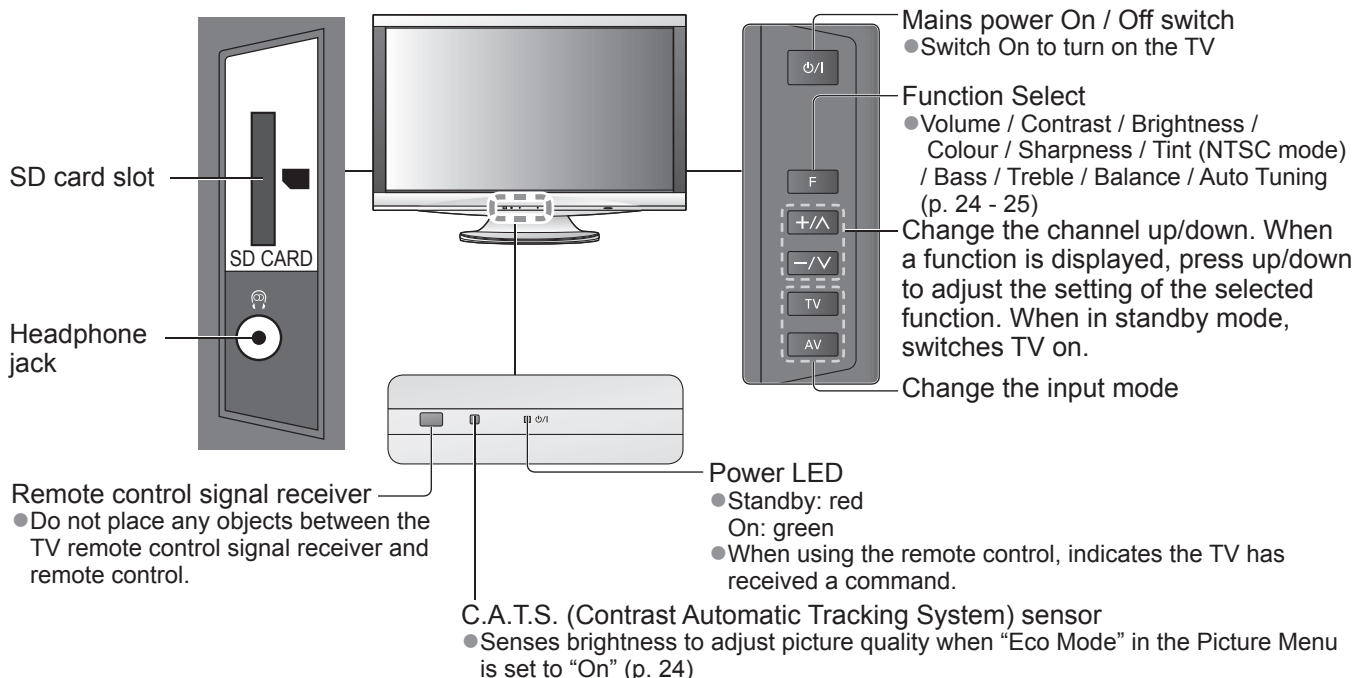

# Remote Control

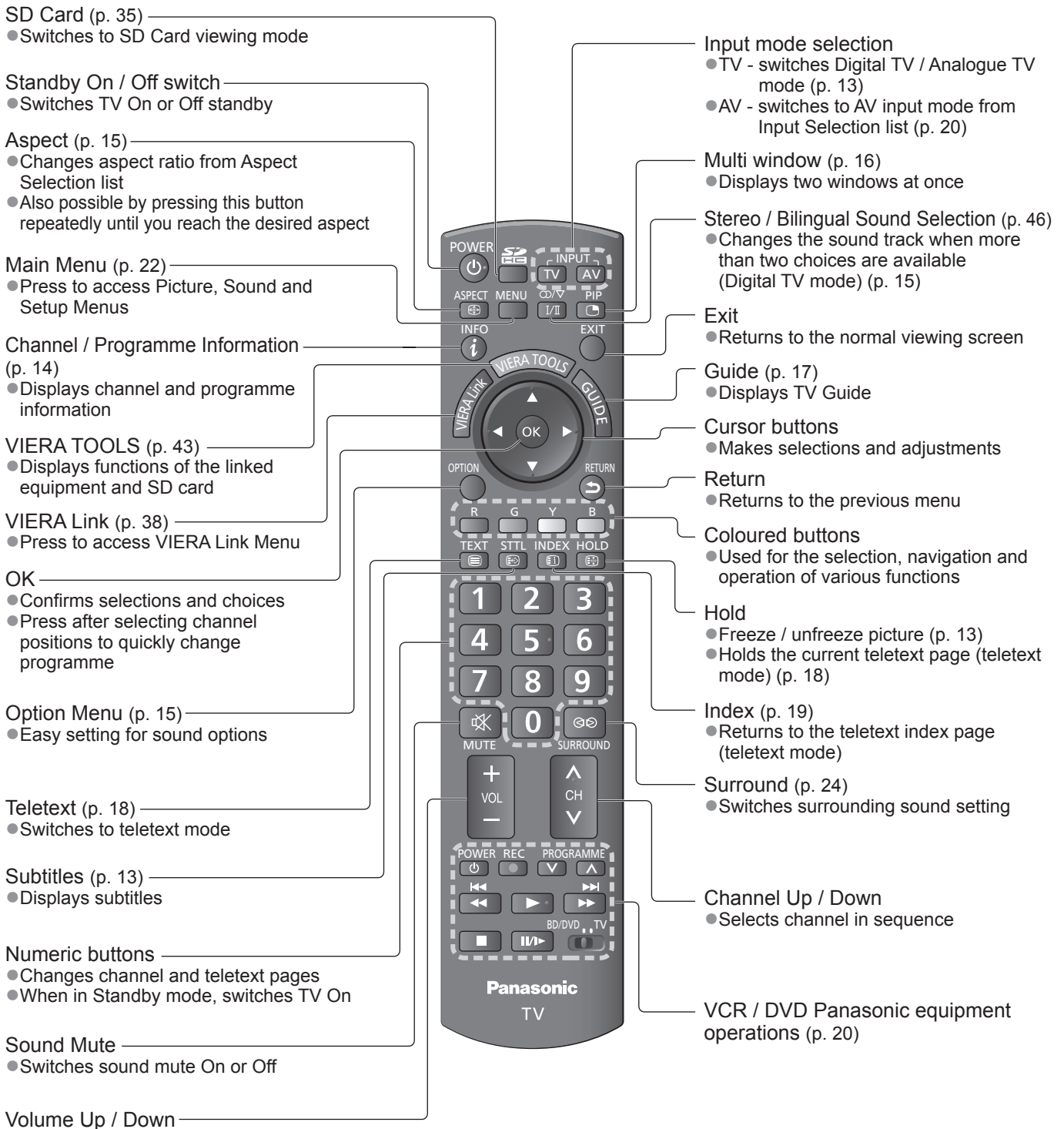

# Basic Connection

External equipment and cables shown are not supplied with this TV.  
Please ensure that the TV is disconnected from the mains socket before attaching or disconnecting any leads.

## Connecting aerial

### TV only

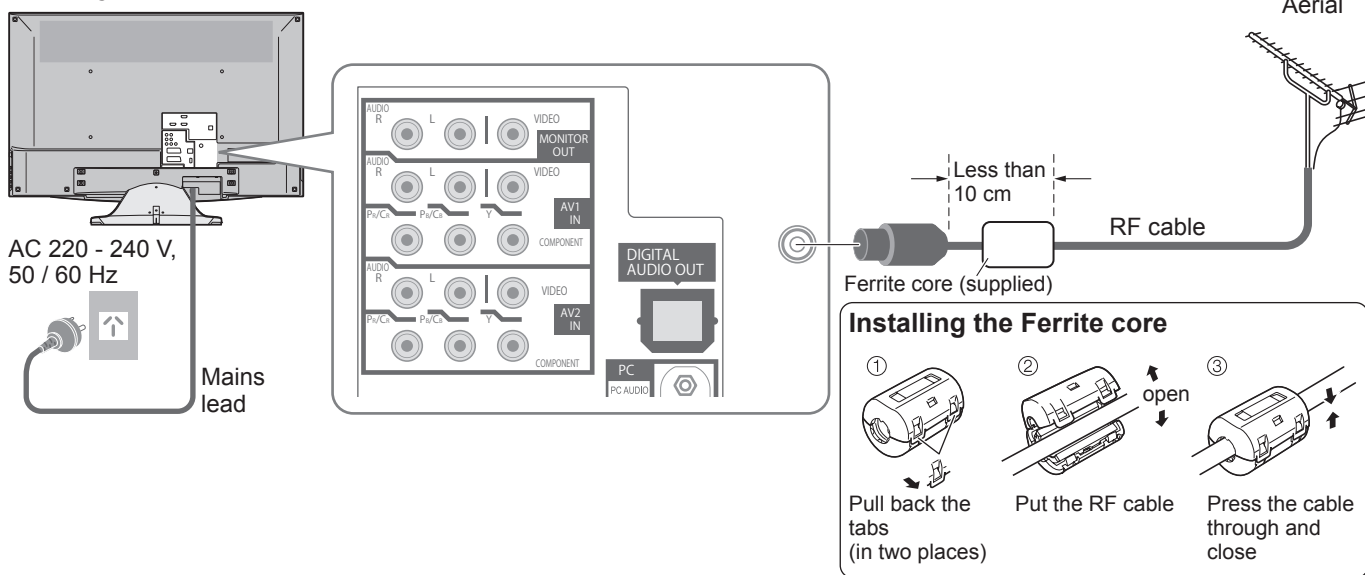

## Connecting DVD Recorder / VCR

### TV, DVD Recorder or VCR

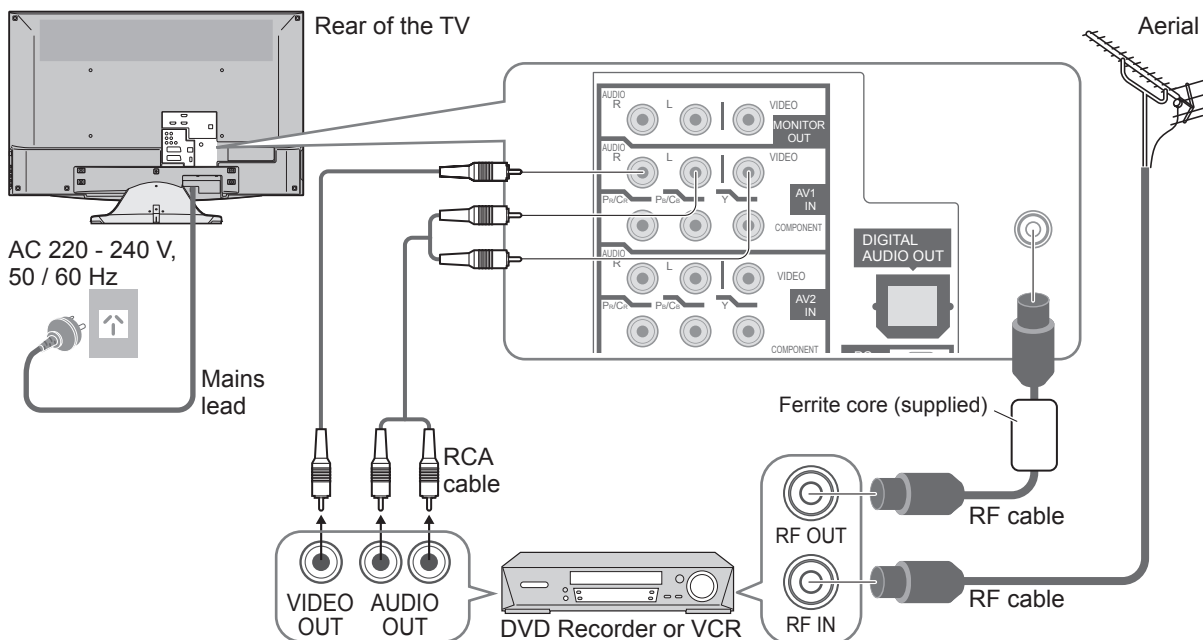

#### Note

- Keep the space between the TV and RF cable to prevent distorted image.
- Do not put the RF cable close to the mains lead to avoid noise.
- Do not place the RF cable under the TV.
- To obtain optimum quality picture and sound, an Aerial, the correct cable (75  $\Omega$  coaxial) and the correct terminating plug are required.
- If a communal Aerial system is used, you may require the correct connection cable and plug between the wall Aerial socket and the TV.
- Your local Television Service Centre or dealer may be able to assist you in obtaining the correct Aerial system for your particular area and the accessories required.
- Any matters regarding Aerial installation, upgrading of existing systems or accessories required, and the costs incurred, are the responsibility of you, the Customer.
- VIERA Link connection  $\rightarrow$  p. 38
- Read the manual of the equipment too.

# Auto Tuning

Search and store TV channels automatically.

These steps are not necessary if the setup has been completed by your local dealer.



- ### 1 Plug the TV into mains socket and switch On



  - You can now use the remote control to turn On the TV or switch the TV to standby mode. (Power LED: On)
- ### 2 Select your area

Select State / Territory

New South Wales / Australian Capital Territory
Victoria
Queensland
South Australia
Western Australia
Northern Territory
Tasmania

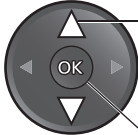
 ① select  
② set
- ### 3 Select Auto Scan Type

Auto Scan Type

All Channels
Digital TV Channels only

 select
- ### 4 Start Auto Tuning



Auto Tuning			
RF Ch	Channel Name	Type	Quality
62	CBBC Channel	Digital TV	10
62	BBC Radio Wales	Digital TV	10
62	IE4	Digital TV	10
62	Cartoon Nwk	Digital TV	10
29		Analogue TV	-
33		Analogue TV	-

Digital TV: 4      Analogue TV: 2  
Searching

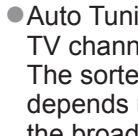
 select

  - Auto Tuning will start to search for TV channels and store them. The sorted channel order depends upon the TV signal, the broadcasting system and reception conditions.
- ### 5 Select the viewing environment

Please select your viewing environment.

Home	Shop
------	------

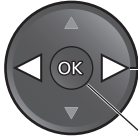
 ① select  
② set

  - “Home” is the recommended mode for viewing at home. Select “Home” for optimal picture / power consumption. “Shop” is for in-store display.
  - Home: “Viewing Mode” is set as “Normal”. (p. 24)
  - Shop: “Viewing Mode” is set as “Dynamic”. (p. 24)

**Auto Tuning is complete**

## If you select “Shop” by mistake

Return to the “Home” or “Shop” Selection menu

Automatic Demo: Off    On     →

Please select your viewing environment.

Home	Shop
------	------

→ **Auto Tuning is complete**

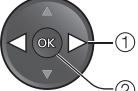
 ① select  
② set

- Once you press the OK button in this menu, the TV is set to Shop mode. Please reset all settings to set to “Home” mode. ➔ “Shipping Condition” (p. 32)

# Auto Tuning

## Using the On-Screen Displays

Many features available on this TV can be accessed via the On-Screen Display menu.

### ON SCREEN HELP Instructions box (example: Sound Menu)

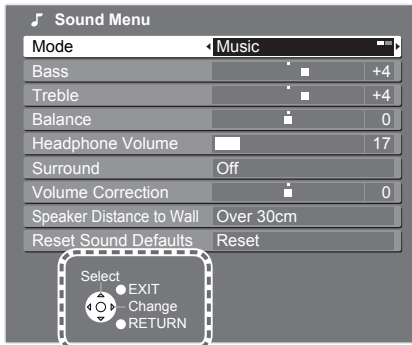

On-screen operation guide

### How to use remote control



Open the Main Menu



Move the cursor / select the menu



Move the cursor / adjust levels / select from a range of options



Access the menu / store settings after adjustments have been made or options have been set



Return to the previous menu



Exit the menu system and return to the normal viewing screen

### Note

- To edit channels → “Editing Channels” (p. 28)
- If tuning has failed → “Tuning Channels” (p. 30)
- To reset all settings → “Shipping Condition” (p. 32)
- If you turned the TV Off during Standby mode last time, the TV will be in Standby mode when you turn the TV On with Mains power On / Off switch.

# Watching TV

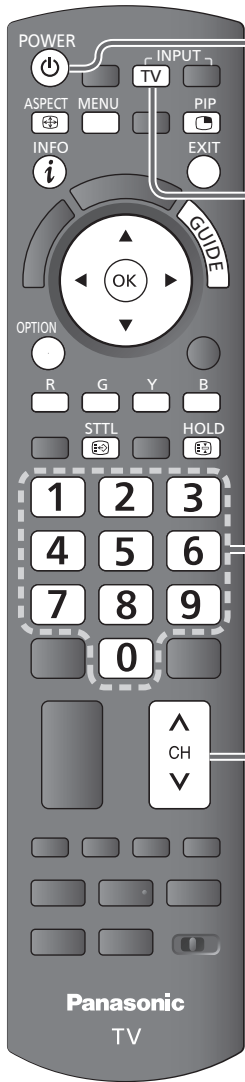

## 1 Turn power on

POWER



- Mains power On / Off switch should be On. (p. 8)

## 2 Select Digital TV or Analogue TV mode



- Also possible to select the mode using the TV button on the side panel of the TV. (p. 8)

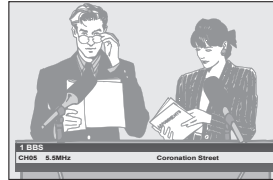

Information banner appears whenever you select a channel

- For details → p. 14

## 3 Select a channel

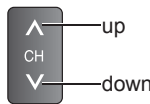

- To select the two or three-digit channel number, e.g. 39  
→ **3** → **9** (in a short time)
- If one or two-digit channel number  
→ **OK** → quickly changes the channel

- To select from the Channel List

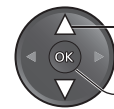
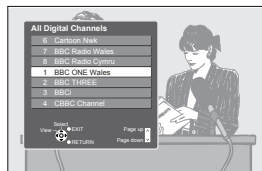

① select a channel

② watch

### Note

- When the TV is switched to standby, there will be a clicking sound after a short delay. This is normal.

### Select a channel using information banner (p. 14)

Possible to confirm the programme name before selecting channels.

Display information banner if it is not displayed



While the banner is displayed, select a channel



① select a channel

② watch

- Possible to set display timeout in "Banner Display Timeout" (p. 25).

### Select a channel using TV Guide (Digital TV mode) (p. 17)

Possible to confirm the TV Guide (EPG) before selecting channels.

Display TV Guide



Select a channel

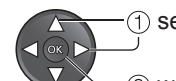

① select a channel

② watch

### Other useful functions

Hold

HOLD



Freeze / unfreeze picture

Display subtitles

STTL



Display / hide subtitles (if available)

# Watching TV

## Other useful functions

### Display information banner



#### Display information banner

- Also appears when changing channels

Programme name Channel Current time

1 TEN Digital	10:30am	All Digital Channels
Coronation Street		Select favourites
9:00am - 11:00 am	◀ Now ▶	Software update
Rating: PG	Bad signal	

Digital TV: Programme Start / Finish time (example)  
 Analogue TV: Channel status

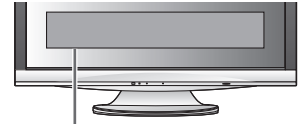

#### Features available / Message meanings

	Sound mute On	<b>Bad signal</b>	Poor TV signal quality (Digital TV mode)		Teletext service available
	Audio mode (p. 46) (Analogue TV mode)	<b>Encrypted</b>	Scrambled programme (Digital TV mode)		Multiple audio available (Digital TV mode)
<b>Rating:</b>	Rating information (Digital TV mode) (p. 46)		Subtitle service available (Digital TV mode)	<b>1 - 90</b>	Off Timer remaining time ● For settings ➔ see below

- To confirm another tuned channel name ➔
- To select a favourite list (Digital TV mode) ➔
- Information on the next programme (Digital TV mode) ➔
- To watch the programme listed in the banner ➔
- To hide ➔
- To set display timeout ➔ "Banner Display Timeout" (p. 25)
- Extra information (press again to hide the banner) (Digital TV mode) ➔

### Off Timer

#### Turn the TV off automatically after a fixed period of time (Off / 15 / 30 / 45 / 60 / 75 / 90 minutes)

MENU ➔ ➔ select

Select "Off Timer" and set the time

- To cancel ➔ Set to "Off" or turn the TV off.
- To display the remaining time ➔ Information banner
- When the remaining time is within 3 minutes, the remaining time will flash on screen.

#### Adjust the standard time **Region Select**

Select the region where you live to adjust the standard time.

- The time contained in the broadcast signal is UTC (Universal Time coordinated) formally known as GMT (Greenwich Mean Time).

#### Adjust for Summer Time **Daylight Saving Time**

Select time offset from the standard time for Summer Time.

- Normally select "Auto".
- If there is a gap between displayed time and actual time, set this function.

Region	Standard time	Daylight Saving Time: Auto (During Summer Time)
NSW / ACT	+10:00	+11:00
Victoria		
Queensland	+10:00	
South Australia	+9:30	+10:30
Western Australia	+8:00	+9:00
Northern Territory	+9:30	
Tasmania	+10:00	+11:00

(Based on GMT)

- These items can be set from "Other settings" in Setup Menu. (p. 23, 25)

## Other useful functions

### Display the selectable settings for the current programme

**OPTION** **Check or change the current programme status instantly**

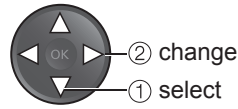

Change the settings

#### **Audio Selection** (Digital TV mode)

Allows you to select between alternative language for sound tracks (if available)

#### **Volume Correction**

Adjusts volume of individual programme or input mode

#### **MPX** (Analogue TV mode)

➔ Sound Menu (p. 24)

#### **Note**

- Also possible to change the settings in Menu list (p. 24 and p. 25).

### Change aspect ratio

**ASPECT**



**Change the aspect ratio**



Aspect Selection list

Enjoy viewing the picture at its optimum size and aspect.

**ASPECT**



Display Aspect Selection list ➔

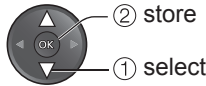

While the list is displayed, select the mode

- To change the mode using the ASPECT button only

➔ Press repeatedly until you reach the desired mode



16:9

Directly displays the image at "16:9" without distortion (anamorphic).



14:9

Displays the image at the standard "14:9" without distortion.



Just

Displays a "4:3" image full-screen. Stretching is only noticeable at the left and right edges.



4:3

Displays the image at the standard "4:3" without distortion.



4:3 Full

Displays a "4:3" image enlarged horizontally to fit the screen.  
● Digital TV mode and HD signal only



Zoom1

Displays a "16:9" letterbox or "4:3" image without distortion.



Zoom2

Displays a "16:9" letterbox (anamorphic) image full-screen without distortion.



Zoom3

Displays a "2.35:1" letterbox (anamorphic) image full-screen without distortion.  
At "16:9", displays the image at its maximum (with slight enlargement).

#### **Note**

- Only "16:9" and "4:3 Full" are available in Digital TV mode.
- Only "16:9" and "4:3" are available in PC mode.
- Only "16:9" is available when "Viewing Mode" is set to "Game".
- Not available in teletext mode and multi window.
- Aspect mode can be memorized separately for SD (Standard definition) and HD (High definition) signals. (except Digital TV mode)

# Watching TV

## Other useful functions

### Multi window



#### View in multi window

- Remote control operations apply to the main screen.

Enjoy viewing two images at once, such as a TV programme and a DVD.

#### Picture-in-Picture mode (PinP)



#### Picture-and-Picture mode (PandP)



Main screen    Sub screen

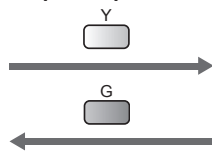

Colour bar

#### Operations in multi window

- To exit multi window (return to the single-screen view with main screen) →
- To change the layout or images, first show the colour bar →



- To change the layout →

- To exit multi window →

- To change the input mode of sub screen

→ Swap sub screen for main screen → Change the input mode with the remote control (p. 20)

→ Swap again

#### Note

- The same input mode cannot be displayed at once.
- The sound is active for main screen only in multi window.
- You cannot change the aspect ratio in multi window.
- This function is not available for PC or SD card.
- Component or HDMI input is available only as the main screen.
- Some signals are reformatted for suitable viewing on your display.
- The display timeout for the input mode or programme position can be adjusted by "Banner Display Timeout" in Setup Menu (p. 25).

# Using TV Guide

Using TV Guide enables you to select programme easily, view programme informations, etc. TV Guide—Electronic Programme Guide (EPG) provides an on-screen listing of the programmes currently broadcast and the future broadcasts over the next seven days (depending on the broadcasters).

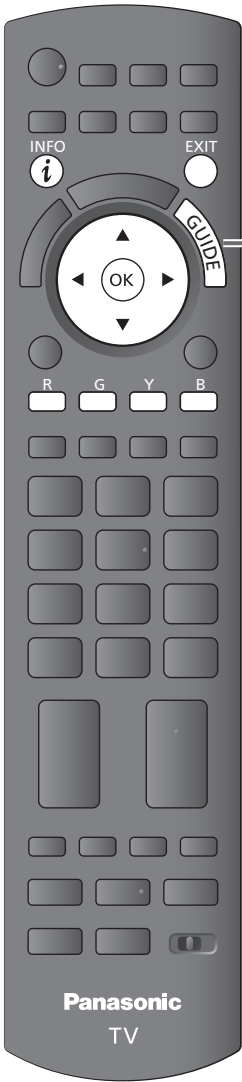

## View TV Guide

Each time pressed, the layout will be changed. (Landscape / Portrait)

Example:

TV Guide date	TV Guide time	Programme name
Wed 26.03.2008	3:00 am - 3:30 am	Eastender
Wed 26.03.2008	3:30 am - 4:30 am	DIY SOS
Wed 26.03.2008	4:00 am - 4:30 am	The Bill
Wed 26.03.2008	4:30 am - 5:00 am	Red Cap
Wed 26.03.2008	5:00 am - 5:30 am	Sports

Landscape (Displays by channel)

Example:

TV Guide date	TV Guide time	Programme name
Wed 26.03.2008	3:00 am - 3:30 am	Eastender
Wed 26.03.2008	3:30 am - 4:30 am	DIY SOS
Wed 26.03.2008	4:00 am - 4:30 am	The Bill
Wed 26.03.2008	4:30 am - 5:00 am	Red Cap
Wed 26.03.2008	5:00 am - 5:30 am	Live Junction
Wed 26.03.2008	5:30 am - 6:00 am	POP 100
Wed 26.03.2008	6:00 am - 6:30 am	Rugby

Portrait (Displays by time)

- To the previous day → R
- To the next day → G
- To watch the programme
  - ① select
  - ② watch
- To view details of the programme
  - Select the programme
  - INFO
  - Press again to return to TV Guide.

## To view a channel list of the selected favourite list

→ B

(favourite list)

Favourites
All Channels
All Digital Channels
All Analogue Channels
Favourites1
Favourites2
Favourites3
Favourites4

① select a favourite list  
② view

To list favourite channels → p. 29

## To view a channel list of the selected type

→ Y

(Type list)

Prog. type
All Types
All Types
Movie
News
Entertainment
Sport
Children's
Music
...

① select type  
② view

To return to TV → EXIT

### Note

● When this TV is turned on for the first time, or the TV is switched off for more than a week, it may take some time before the TV Guide is completely shown.

# Viewing Teletext

You can enjoy teletext broadcasting, including news, weather forecasts and subtitles, if this service is provided by the broadcasters.

**To change mode** → “Teletext” in Setup Menu (p. 25)

**1 Switch to Teletext**  
 TEXT ● Displays Index (content varies depending on the broadcasters)

**2 Select the page (up to page 899)**  
 1 2 3  
 4 5 6  
 7 8 9  
 0  
 or ◀ OK ▶ or ▲ CH ▼ or R G Y B  
 (Corresponds to the colour bar)

**To adjust contrast**  
 → MENU (Press three times) → ▶ OK ◀ As the blue bar is displayed

**To return to TV** → TEXT or EXIT

Sub page number  
 << 01 02 03 04 05 06 07 >>  
 Current page number **P100** 17:51 28 Feb Time / date  
**TELETEXT INFORMATION**  
 Colour bar

## What is FASTEXT mode?

In FASTEXT mode, four differently coloured subjects are situated at the bottom of the screen. To access more information about one of these subjects, press the appropriately coloured button. This facility enables fast access to information on the subjects shown.

## What is TOP mode? (in case of TOP text broadcasting)

TOP is a particular improvement of the standard teletext service that results in an easier search and effective guide.

- Fast overview of the teletext information available
- Easy to use step-by-step selection of the topical subject
- Page status information at the bottom of the screen

Available page up / down → R G

To select among subject blocks → B

To select next subject within the subject block (After the last subject, it moves to the next subject block.) → Y

## What is List mode?

In List mode, four differently coloured page numbers are situated at the bottom of the screen. Each of these numbers can be altered and stored in the TV's memory. (“Store frequently viewed pages”, p. 19)

## Using teletext conveniently

Hold		Reveal hidden data	
HOLD 	<b>Stop automatic updating</b> (If you wish to hold the current page without updating) To resume → HOLD 	MENU → R	Reveal hidden words e.g. quiz page answers <b>Re-hide</b> → R 
INDEX		Call up Subtitles	
INDEX 	<b>Return to the main index page</b>	STTL 	<b>Display subtitles</b> <ul style="list-style-type: none"> <li>● Call up P801 (subtitle page) if available.</li> <li>● If you press this button during P801 is displayed, teletext mode will be cancelled and return to TV.</li> </ul>

## Using teletext conveniently

### View in multiwindow

#### Watch TV and Teletext in two windows at once



- Operations can be made only in Teletext screen.

### FULL / TOP / BOTTOM

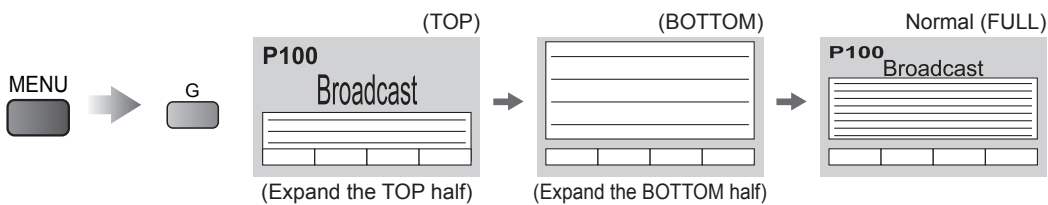

### Store frequently viewed pages

#### Store frequently viewed pages in the colour bar (List mode only)

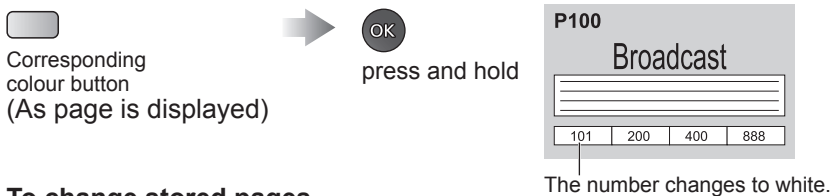

#### To change stored pages

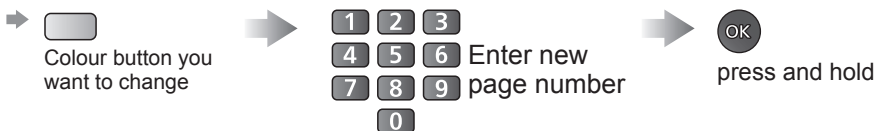

### View sub page

#### View sub page (Only when teletext is more than one page)

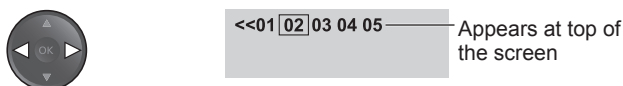

#### To view specific sub page

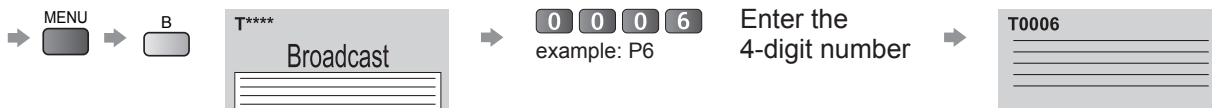

- Sub pages:  
The number of sub pages varies depending on the broadcasters.  
It may take some time for searching, during which time you can watch TV.

### Watch TV while waiting for update

#### View the TV picture while searching for a teletext page

Teletext automatically updates itself when new information becomes available.

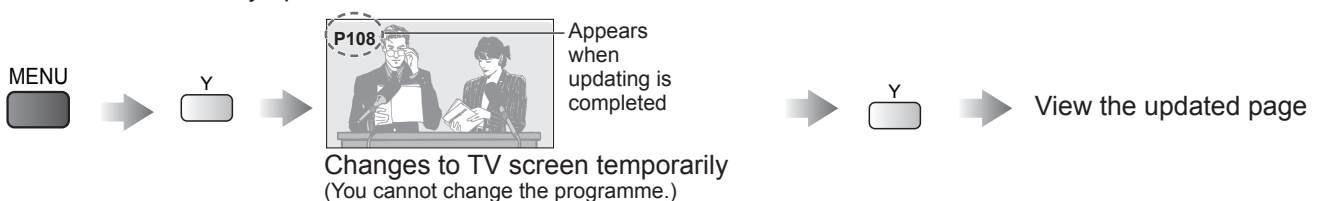

- The news page provides a function that indicates arrival of latest news ("News Flash").

# Watching Videos and DVDs

Connect the external equipment (VCRs, DVD equipment, etc.) and you can watch the input.

● To connect the equipment → p. 10

You can operate some functions of selected Panasonic external equipment with this remote control.



## 1 Display the input selection menu



## 2 Select the input mode of the connected equipment

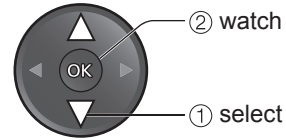
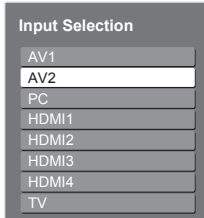

● You can also select the input using the AV button on the remote control or the side panel of the TV.

Press the button repeatedly until the desired input is selected.

● You can label or skip each input mode → “Input Labels” (p. 26)

## 3 View

Displays the selected mode

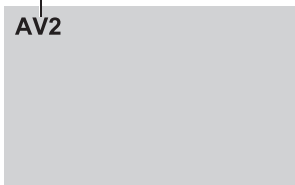









### Note

- If the external equipment has an aspect adjustment function, set to “16:9”.
- For details, see the manual of the equipment or ask your local dealer.

To return to TV →

Panasonic equipment connected to the TV can be directly operated with the remote control.

	<p><b>BD/DVD / TV switch*</b>          Switch to BD/DVD to operate Panasonic DVD Recorder, DVD Player, Player theatre, Blu-ray Disc theatre or VCR          Switch to TV to operate VIERA Link equipment          ➔ “VIERA Link Control” (p. 41)</p>
	<p><b>Standby</b>          Set to Standby mode / Turn on</p>
	<p><b>Play</b>          Playback videocassette / DVD</p>
	<p><b>Stop</b>          Stop the operations</p>
	<p><b>Rewind / Skip / Search</b>          VCR: Rewind, view the picture rapidly in reverse          DVD: Skip to the previous track or title          Press and hold to search backward</p>
	<p><b>Fast-forward / Skip / Search</b>          VCR: Fast-forward, view the picture rapidly forward          DVD: Skip to the next track or title          Press and hold to search forward</p>
	<p><b>Pause</b>          Pause / Resume          DVD: Press and hold to play at slow speed</p>
	<p><b>Programme Up / Down</b>          Select programme</p>
	<p><b>Record</b>          Start recording</p>

**\*Setting your remote control to operate Panasonic VCR, DVD, etc.**

① Switch to BD/DVD ➔ 

② Press and hold  during the following operations

Enter the appropriate code  
 See table below

 ➔ Press 

Type of equipment	Code
DVD Recorder / DVD Player / Blu-ray Disc Player	70 (default)
Player theatre / Blu-ray Disc theatre	71
VCR	72

**Note**

- Confirm if the remote control works correctly after changing the code.
- The codes will be reset to default values if batteries are replaced.
- Some operations may not be possible on some equipment models.

# How to Use Menu Functions

Various menus allow you to make settings for the picture, sound, and other functions.



**1 Display the menu**  
 MENU • Displays the functions that can be set (varies according to the input signal)

**2 Select the menu**  
  
 (example)  

 ② access  
 ① select

**3 Select the item**  
  
 (example)  

 select

**4 Adjust or select**  
  
 (example)  

 ① change  
 ② store or access (Required by some functions)

**To return to TV at any time**



**To return to the previous screen**



**To change menu pages**

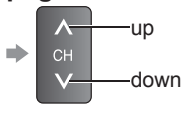

**Choose from among alternatives**  
 Number and positions of alternatives  
  
 Changed

**Adjust using the slide bar**  
  
 Moved

**Go to the next screen**  
  
 Displays the next screen

**Enter characters by free input menu**  
  
 • To delete a character →   
 • To delete all characters →

**To reset the settings**  
 • To reset the picture settings only  
 → “Reset Picture Defaults” in Picture Menu (p. 24)  
 • To reset the sound settings only  
 → “Reset Sound Defaults” in Sound Menu (p. 24)  
 • To reset all settings  
 → “Shipping Condition” (p. 32) in Setup Menu

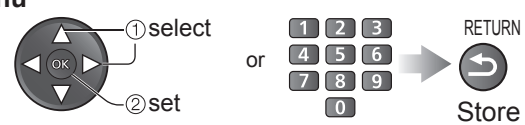

Every press changes the character by one. Leave it for a second to set the character, or press OK or any numeric button within a second.

See the table below for the corresponding characters for each numeric button.

Numeric buttons	Characters	Numeric buttons	Characters
1	. ! : # + - * _ ( )	6	m n o 6 M N O
2	a b c 2 A B C	7	p q r s 7 P Q R S
3	d e f 3 D E F	8	t u v 8 T U V
4	g h i 4 G H I	9	w x y z 9 W X Y Z
5	j k l 5 J K L	0	Space 0

# Overview

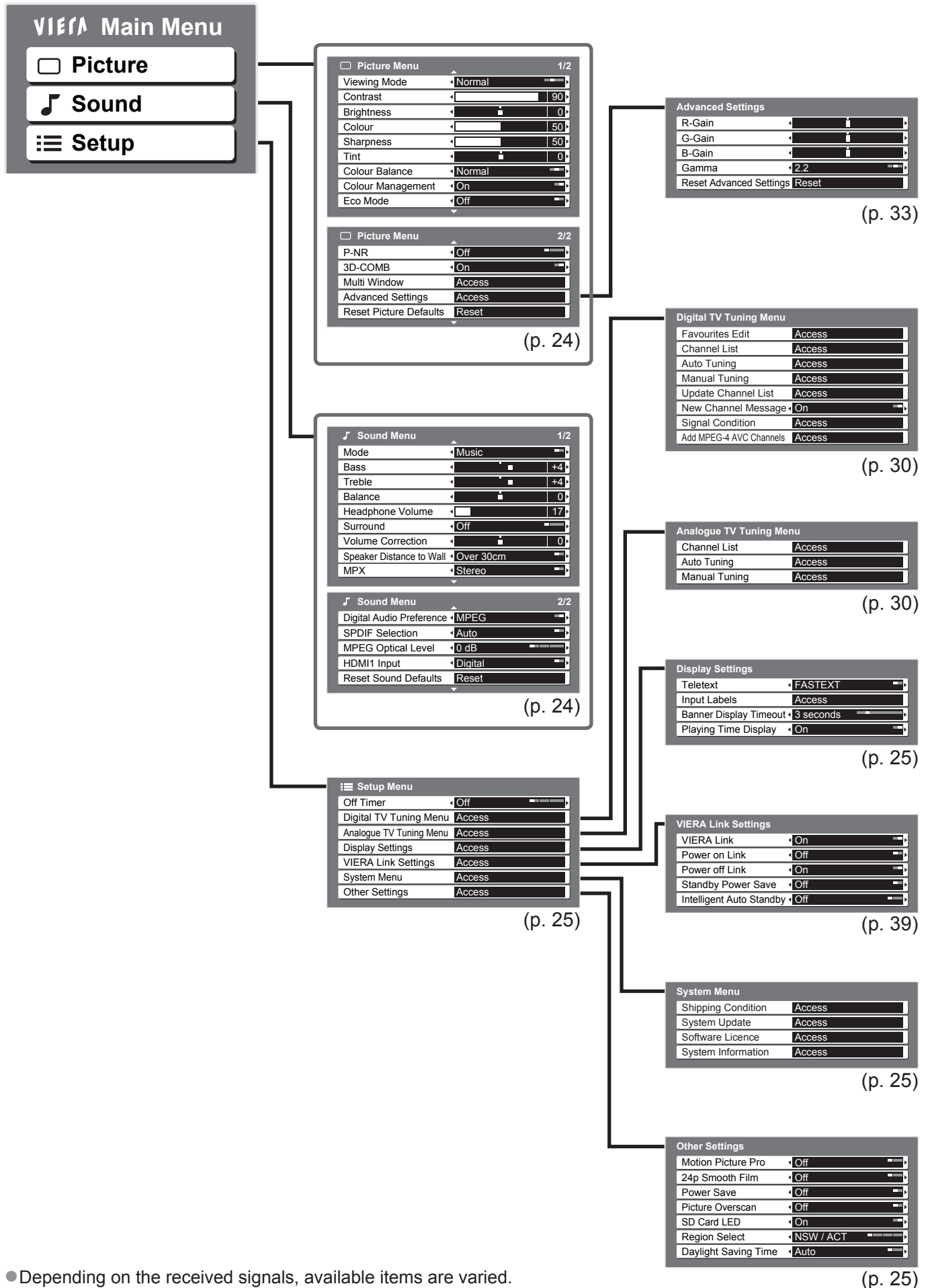

● Depending on the received signals, available items are varied.

# How to Use Menu Functions

## Menu list

Menu	Item	Adjustments / Configurations (alternatives)
Picture	<b>Viewing Mode</b>	Basic picture mode ( <b>Dynamic / Normal / Cinema / Game</b> ) Dynamic : Provides enhanced picture contrast and sharpness when viewing in a bright room Normal : Recommended for viewing under normal ambient room lighting conditions Cinema : For watching movies in a darkened room producing a cinema-like picture Game : Game playing time is displayed only when connecting a game equipment. ●Set for each input signal.
	<b>Contrast, Brightness, Colour, Sharpness</b>	Increases or decreases the levels of these options according to your personal preference
	<b>Tint</b>	With an NTSC signal source connected to the TV, the picture hue can be adjusted to suit your taste. ●For NTSC or Component / HDMI input signal reception only
	<b>Colour Balance</b>	Allows you to set the overall colour tone of the picture ( <b>Cool / Normal / Warm</b> )
	<b>Colour Management</b>	Automatically adjusts colours to vivid ones ( <b>Off / On</b> ) ●Not valid on PC signal
	<b>Eco Mode</b>	Adjusts picture settings automatically dependent on ambient lighting conditions ( <b>Off / On</b> )
	<b>P-NR</b>	Picture Noise Reduction Automatically reduces unwanted picture noise and flicker noise in the contoured parts of a picture ( <b>Off / Min / Mid / Max</b> ) ●Not valid on PC signal
	<b>3D-COMB</b>	Occasionally, whilst viewing still or slow moving pictures, colour patterning may be seen. Set to "On" to display sharper and more accurate colours. ( <b>Off / On</b> ) ●For PAL or NTSC signal reception only ●Not valid on Component, PC, HDMI and SD Card
	<b>Multi Window</b>	Splits the screen into two windows. (p. 16)
	<b>Advanced Settings</b>	Set for colour balance, view and position. (p. 33) Set for colour balance in Normal or Cinema viewing mode.
	<b>Reset Picture Defaults</b>	Press the OK button to reset the present Picture Menu to the default settings.
Sound	<b>Mode</b>	Basic sound mode ( <b>Music / Speech</b> )
	<b>Bass</b>	Increases or decreases level to enhance or minimise lower, deeper sound output
	<b>Treble</b>	Increases or decreases level to enhance or minimise sharper, higher sound output
	<b>Balance</b>	Adjusts volume level of right and left speakers
	<b>Headphone Volume</b>	Adjusts the volume of the headphones
	<b>Surround</b>	Surround sound settings ( <b>Off / V-Audio / V-Audio Surround / V-Audio ProSurround</b> ) V-Audio: Provides a dynamic enhancer to simulate improved spatial effects V-Audio Surround: Provides a dynamic enhancer of width and depth to simulate improved spatial effects V-Audio ProSurround: Provides a three-dimensional sound space with digital reverb effects ●Switching is also possible by the Surround button on the remote control. (p. 9)
	<b>Volume Correction</b>	Adjusts volume of individual channel or input mode
	<b>Speaker Distance to Wall</b>	Adjusts the low frequency sound ( <b>Over 30cm / Up to 30cm</b> ) ●Over 30cm: Recommended when the back space between the TV and wall is over 30 cm ●Up to 30cm: Recommended when the back space between the TV and wall is within 30 cm
	<b>MPX</b>	Selects stereo / monaural ( <b>Mono / Stereo</b> ) (p. 46) ●Normally: Stereo ●Stereo signal cannot be received: Mono ●M1 / M2: Available while mono signal is transmitted ●Analogue TV mode only
	<b>Digital Audio Preference</b>	Selects the initial setting for Audio tracks ( <b>Dolby D / MPEG</b> ) If programme has both Dolby Digital and MPEG audio tracks, priority is given to what you select Dolby D: A method of coding digital signals developed by Dolby Laboratories. Apart from stereo (2ch) audio, these signals can also be multi-channel audio. MPEG: An audio compression method that compresses audio to small size without any considerable loss of audio quality. ●Digital TV mode only
	<b>SPDIF Selection</b>	Selects the initial setting for digital audio output signal from DIGITAL AUDIO OUT terminal ( <b>Auto / PCM</b> ) Auto: Dolby Digital is output as Dolby Digital Bitstream. MPEG is output as PCM. PCM: Dolby Digital is output as PCM. MPEG is output as PCM. ●Digital TV mode only
	<b>MPEG Optical Level</b>	You can adjust the audio level of MPEG output from DIGITAL AUDIO OUT terminal as the initial setting. ●0dB to -12dB in -2dB reductions ●Digital TV mode only
	<b>HDMI1 Input</b>	Select to fit the input signal ( <b>Digital / Analogue</b> ) (p. 34) Digital: HDMI cable connection Analogue: HDMI-DVI adapter cable connection ●HDMI input mode only ●HDMI2 / 3 / 4 terminals are for digital signal only.
<b>Reset Sound Defaults</b>	Press the OK button to reset the present Sound Menu to the default settings.	

Menu	Item	Adjustments / Configurations (alternatives)	
Setup	<b>Off Timer</b>	Sets the time the TV automatically turns Off ( <b>Off / 15 / 30 / 45 / 60 / 75 / 90 minutes</b> ) (p. 14)	
	<b>Tuning Menu</b>	<b>Favourites Edit</b>	Creates list of favourite channels (Digital TV mode) (p. 29)
		<b>Channel List</b>	Skips the unwanted channels (p. 29)
		<b>Auto Tuning</b>	Sets all Digital TV or Analogue TV channels automatically (p. 30)
		<b>Manual Tuning</b>	Sets the TV channels manually (p. 31)
		<b>Update Channel List</b>	Update the channel list. (Digital TV mode) (p. 31)
		<b>New Channel Message</b>	Displays a message when new Digital TV channels are found. ( <b>Off / On</b> ) (p. 31)
		<b>Signal Condition</b>	Checks the Digital TV signal condition (p. 31)
		<b>Add MPEG-4 AVC Channels</b>	Activates the reception of MPEG-2 and MPEG-4 AVC channels <ul style="list-style-type: none"> <li>● Use this function if MPEG-4 AVC services start in your area.</li> <li>● All previous tuning settings are erased.</li> <li>● Once activated, this option is removed from the Digital TV Tuning Menu.</li> </ul>
	<b>Display Settings</b>	<b>Teletext</b>	Teletext display mode ( <b>FASTEXT / List</b> ) (p. 18)
		<b>Input Labels</b>	Labels or skips each input mode (p. 26)
		<b>Banner Display Timeout</b>	Sets how long the information banner stays on screen from 0 (No display) to 10 sec. in 1-sec. increments
		<b>Playing Time Display</b>	Displays the length of time in every thirty minutes for playing game ( <b>Off / On</b> ) <ul style="list-style-type: none"> <li>● When "Viewing Mode" is set to "Game"</li> </ul>
	<b>VIERA Link Settings</b>	<b>VIERA Link</b>	Sets to use VIERA Link functions ( <b>Off / On</b> ) <ul style="list-style-type: none"> <li>● VIERA Link functions become available when "VIERA Link" is set to "On". (p. 39)</li> </ul>
		<b>Power on Link</b>	Sets to use Power on Link functions ( <b>Off / On</b> ) (p. 39)
		<b>Power off Link</b>	Sets to use Power off Link functions ( <b>Off / On</b> ) (p. 39)
		<b>Standby Power Save</b>	Controls the power consumption in Standby mode of the connected equipment to reduce the consumption ( <b>Off / On</b> ) (p. 39)
		<b>Intelligent Auto Standby</b>	Makes unwatched or unused connected equipment go into Standby mode to reduce the power consumption ( <b>Off / On (With reminder) / On (No reminder)</b> ) (p. 39)
	<b>System menu</b>	<b>Shipping Condition</b>	Resets all settings to the original condition (p. 32)
		<b>System Update</b>	Downloads new software to TV (p. 27)
		<b>Software Licence</b>	Displays the software licence information
		<b>System Information</b>	Displays the system information of this TV
	<b>Other Settings</b>	<b>Motion Picture Pro</b>	Automatically compensates the picture frame rate to make the image smooth ( <b>Off / Mid / Max</b> ) <ul style="list-style-type: none"> <li>● Not valid on PC, Photo View on SD card or when "Viewing Mode" is set to "Game".</li> <li>● Set to "Off" if noise is generated on the screen.</li> </ul>
		<b>24p Smooth Film</b>	Automatically compensates the picture frame rate to make the image smooth ( <b>Off / Mid / Max</b> ) <ul style="list-style-type: none"> <li>● 24p signal input only</li> <li>● Set to "Off" if noise is generated on the screen.</li> </ul>
		<b>Power Save</b>	Reduces brightness of picture to minimise power consumption ( <b>Off / On</b> )
		<b>Picture Overscan</b>	Selects the screen area for displaying the image ( <b>Off / On</b> ) On: Enlarges the image to hide the edge of the image Off: Displays the image in the original size <ul style="list-style-type: none"> <li>● Set to "On" if noise is generated on the edges of the image.</li> <li>● This function is available when aspect is set to "16:9".</li> <li>● This function can be memorized separately for SD (Standard Definition) and HD (High Definition) signals.</li> </ul>
		<b>SD Card LED</b>	Lights blue LED while SD Card is inserted ( <b>Off / On</b> ) (p. 35)
		<b>Region Select</b>	Selects the region where you live to adjust the standard time ( <b>NSW / ACT / Victoria / Queensland / South Australia / Western Australia / Northern Territory / Tasmania</b> ) (p. 14)
		<b>Daylight Saving Time</b>	Select time offset from the standard time for Summer Time ( <b>Auto / Off / +1/2 hour / +1 hour</b> ) (p. 14) <ul style="list-style-type: none"> <li>● Set to "Auto" normally</li> </ul>

- A different menu will be displayed while PC, DVI to HDMI adapter cable or SD Card is used. (p. 33 - 37)
- Only available items can be selected.

# Input Labels

For easier identification and selection of the input mode, you can label each input terminals or skip terminal that is not connected to any equipment. (p. 20)

- 1 Display the menu**  
MENU
- 2 Select "Setup"**  
VIERA Main Menu  
Picture  
Sound  
Setup
- 3 Select "Display Settings"**  
Setup Menu  
Off Timer Off  
Digital TV Tuning Menu  
Display Settings Access  
VIERA Link Settings  
System Menu  
Other Settings
- 4 Select "Input Labels"**  
Display Settings  
Teletext FASTEXT  
Input Labels Access  
Banner Display Timeout 3 seconds  
Playing Time Display On
- 5 Select an input terminal and set**  
Input Labels  
AV1 AV1  
AV2 AV2  
PC PC  
HDMI1 HDMI1  
HDMI2 HDMI2  
HDMI3 HDMI3  
HDMI4 HDMI4  
Digital TV Digital TV  
Analogue TV Analogue TV

To return to TV → EXIT

The labels you set will be displayed in "Input Selection" menu (p. 20) or banner.

● If "Skip" is selected, you cannot select the mode.

## User input

You can name each input terminals freely.

Select "User input"

(maximum: ten characters)  
You can set characters by using numeric buttons.  
→ p. 22

Set characters

Store

# Digital TV Settings

Digital TV Settings provide access to various advanced features.



- 1 If in Analogue TV mode  
**Select Digital TV mode**  
TV
- 2 **Display the menu**  
MENU
- 3 **Select "Setup"**  
VIERA Main Menu  
Picture  
Sound  
Setup
- 4 **Select "System Menu"**  
Setup Menu  
Off Timer Off  
Digital TV Tuning Menu  
Display Settings  
VIERA Link Settings  
System Menu Access  
Other Settings
- 5 **Select "System Update"**  
System Menu  
Shipping Condition  
System Update Access  
Software Licence  
System Information
- 6 **Set**

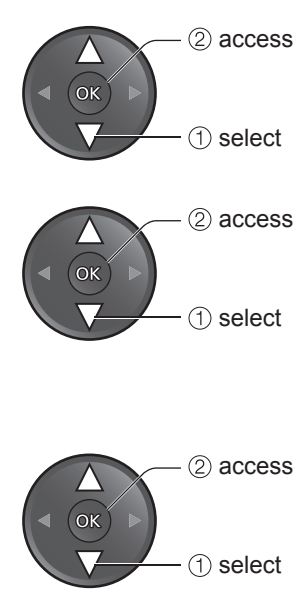

To return to TV → EXIT

## Update TV's software system **System Update**

Download new software to TV.  
● For details → p. 46

**If System Update is performed, the software will be updated. It may change TV functions. If you do not wish to do so, set "Auto Update Search in Standby" to Off.**

Select "Auto Update Search in Standby" and then set "On" or "Off"

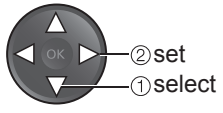

● On: Automatically performs a search in standby and downloads an update, if any software updates are available

### Note

● When the TV is switched to standby, there will be a clicking sound after a short delay. Similar clicking sounds will also occur at 3:00 AM and 5:00 AM (p. 46) when "Auto update Search in Standby" is set to "On". These sounds are normal.

### To update immediately

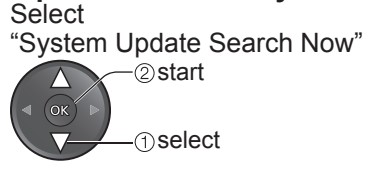

Searches for an update (for several minutes) and displays a corresponding message if any

Download



● Download may take for about 1 hour.

### Note

● During downloading, the TV will display a blank screen for 40 to 50 seconds. Do not interrupt the TV during this procedure.

# Editing Channels

You can make your favourite channel lists, skip unwanted channels, etc.



**1** Select Digital TV or Analogue TV  
TV

**2** Display the menu  
MENU

**3** Select "Setup"  
VIERA Main Menu  
Picture  
Sound  
Setup

**4** Select "Digital TV Tuning Menu" or "Analogue TV Tuning Menu"  
Setup Menu  
Off Timer Off  
Digital TV Tuning Menu Access  
Display Settings  
VIERA Link Settings  
System Menu  
Other Settings

**5** Select "Favourites Edit" or "Channel List"  
Digital TV Tuning Menu  
Favourites Edit Access  
Channel List Access  
Auto Tuning  
Manual Tuning  
Update Channel List  
New Channel Message On  
Signal Condition

**6** Set

To return to TV → EXIT

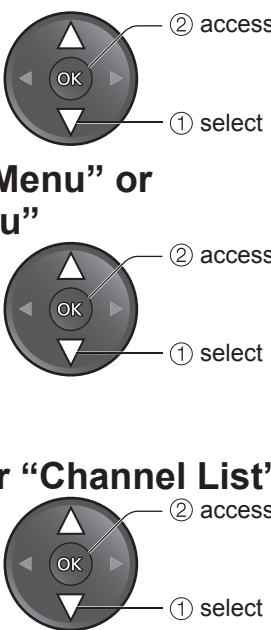

## List favourite channels (Digital TV mode) **Favourites Edit**

Create your favourite channel list (Favourites) from various broadcasters (up to 4: Favourites1 to 4). The list is added to "Favourites" list in TV Guide (p. 17) and information banner (p. 14) and then easily accessed.

### Select a channel and add it to the list

To display another List → **B**

To add all channels to the list → **Y**

A channel is added

### To edit List

Select the field of List to edit and:

- To name the Favourites → **R** → Set characters
- To move the channel → **G** → Select the new position → Confirm **G**
- To delete the channel → **OK**
- To delete all channels → **Y**

You can set characters by using numeric buttons. → p. 22

#### Note

- Channel numbers are defined by the broadcaster and cannot be changed.
- Hidden channels (see below) can be selected but not viewed.

## Skip unwanted channels / Edit channels (Change name, Move) **Channel List**

You can hide unwanted channels. The hidden channels cannot be displayed except in this function. Use this function to skip unwanted channels.

### Select a channel and add / delete

To retune each channel (Manual Tuning) (p. 31) → **R**

You can edit channels.

- If a VCR is connected only with the RF cable, edit "VCR". (Analogue TV mode)

### ① Select a channel to edit

Channel position

Name

### ② Edit

#### To change the displayed name when selecting channels (Only in Analogue TV mode)

Select "Rename" → Set characters

You can set characters by using numeric buttons. → p. 22

(maximum: five characters)

#### To move channel position

For Analogue TV channels

Store **G**

#### To swap channels

For Digital TV channels

Store **G**

# Tuning Channels

You can retune all the TV channels when moving house or search for new channels which may have recently started broadcasting.



**1** Select Digital TV or Analogue TV



**2** Display the menu



**3** Select "Setup"

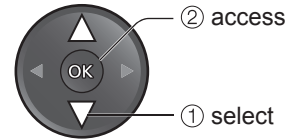

**4** Select "Digital TV Tuning Menu" or "Analogue TV Tuning Menu"

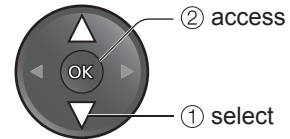
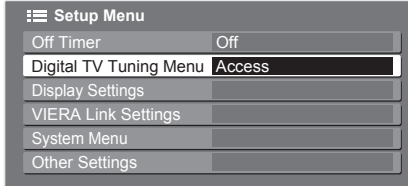

**5** Select a function

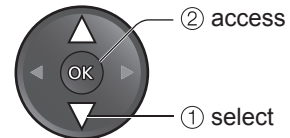
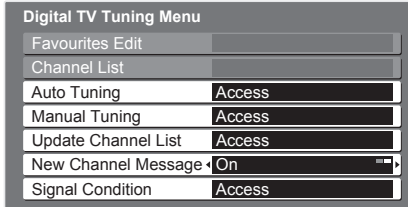

**6** Set

To return to TV → EXIT

For Auto Tuning, using the buttons on the side panel of the TV (p. 8)

- ① Press repeatedly until "Auto Tuning" appears **F**
  - ② Access "Auto Tuning" **TV**
  - ③ Start "Auto Tuning" **TV**
- To return to TV → **F**

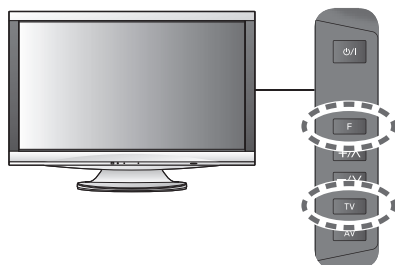

## Set all Digital TV or Analogue TV channels automatically

### Digital TV Auto Tuning or Analogue TV Auto Tuning

Automatically retune all Digital TV or Analogue TV channels received in the area.

- Only Digital TV channels are retuned in Digital TV mode.
- Only Analogue TV channels are retuned in Analogue TV mode.

#### Start Auto Tuning

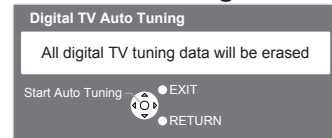

#### Settings are made automatically

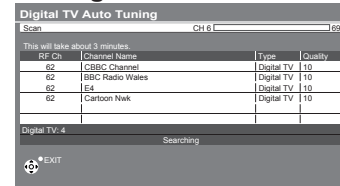

- All the previous tuning settings are erased.
- When the operation is completed, the channel at channel position "1" will be displayed.
- Search begins in the order from the lower channels to the higher channels. Channels received during this process are added to the list. (p. 31)
- If tuning has not been done completely → "Digital TV Manual Tuning", "Analogue TV Manual Tuning" (p. 31)

## Set Digital TV channel manually **Digital TV Manual Tuning**

Normally use "Digital TV Auto Tuning" or "Update Channel List" to update Digital TV channels on your channel list.

If tuning has not been done completely or for adjusting the direction of the aerial, use this function.

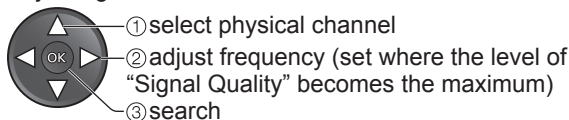
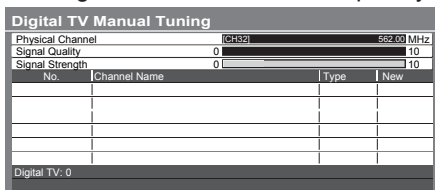

- All channels found will be added to the Digital TV Channel List.

## Set Analogue TV channel manually **Analogue TV Manual Tuning**

### Manual Tuning

Set Analogue TV channel manually after Analogue TV Auto Tuning.

- If a VCR is connected only with the RF cable, select channel position "0".

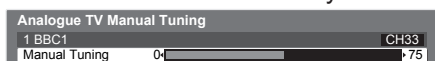

Select a channel position



Select a channel



Search and store

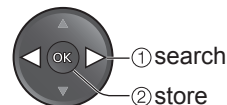

## Update channels automatically **Update Channel List**

You can add new channels, delete duplicated channels, update channel name and position automatically to Channel List.

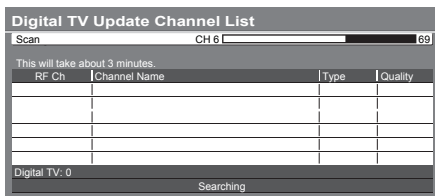

- The Digital TV Channel List is updated with the current settings saved as they are.

## Display a message **New Channel Message**

Selects whether to give a message when new Digital TV channels are found. (Off / On)



## Check Digital TV signal **Digital TV Signal Condition**

Selects a channel and checks the Digital TV signal condition.

- To change the channel →



A good Signal Strength is not an indication of suitable signal for Digital TV reception. Please use the Signal Quality indicator as follows:

### Signal Quality:

- Green bar → Good
- Yellow bar → Poor
- Red bar → Bad (Check the aerial)

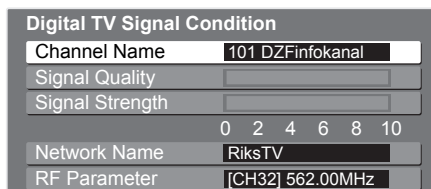

# Restore Settings

## (Shipping Condition)

Resets the TV to its original condition, i.e. no channels tuned in. All settings (channels, picture, sound quality, etc.) are reset.

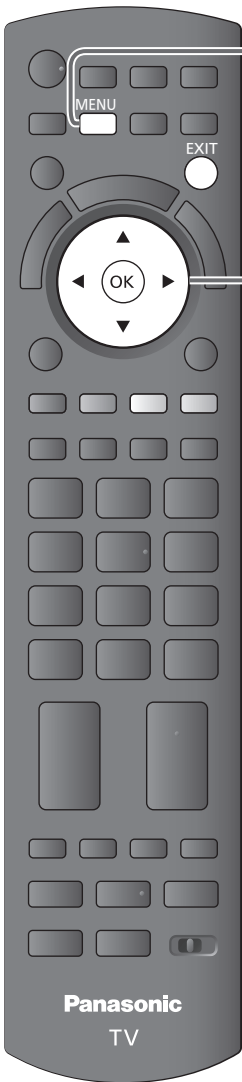

**1 Display the menu**  
MENU

**2 Select "Setup"**

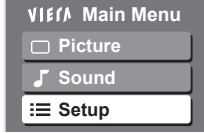

**3 Select "System Menu"**

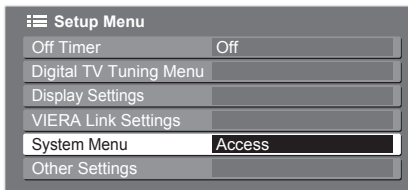

**4 Select "Shipping Condition"**

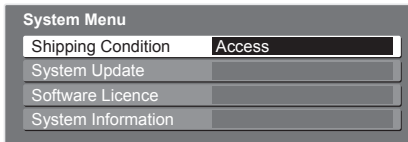

**5 Set**

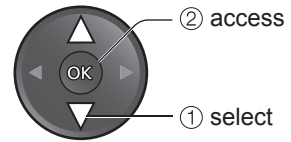
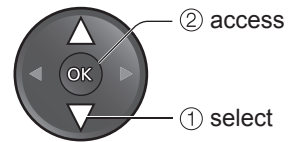
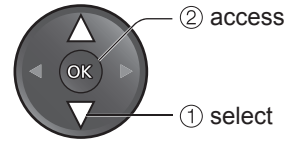

To return to TV →

### Restore Settings Shipping Condition

**① Check the message and reset**

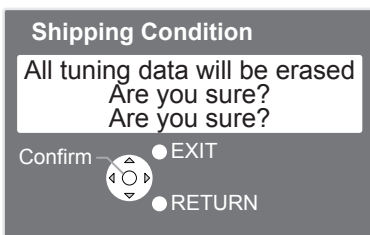

**② Follow the on-screen instructions**

- "Auto Tuning" will automatically start when Mains power On / Off switch is next turned On. (p. 11)

**To retune TV channels only, e.g. after moving house**

- "Digital TV Auto Tuning" or "Analogue TV Auto Tuning" (p. 30)

# Displaying PC Screen on TV

The screen of the PC connected to the TV can be displayed on the TV.  
You can also listen to PC sound with the audio cable connected.

● To connect PC → p. 44



**1** Select the external input

AV

**2** Select "PC"

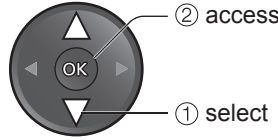
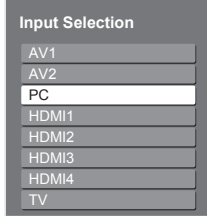

● Corresponding signals → p. 48

● If "H-freq." or "V-freq." is shown in red, the signals may not be supported.

To return to TV → TV

PC menu setting (changed as desired)

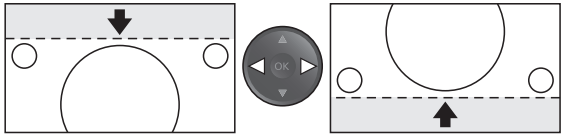
Menu	Item	Adjustments / Configurations (options)	
Picture	Advanced Settings	R-Gain	Adjusts the white balance for red areas
		G-Gain	Adjusts the white balance for green areas
		B-Gain	Adjusts the white balance for blue areas
		Gamma	(2.0 / 2.2 / 2.5)
		Reset Advanced Settings	Press the OK button to reset to the default Picture settings
Setup	PC Setup	Input Resolution	Switches to a wide view ●VGA (640 × 480 pixels), WVGA (852 × 480 pixels), XGA (1,024 × 768 pixels), WXGA (1,280 × 768 pixels, 1,366 × 768 pixels) ●Options change depending on signals
		Clock	Set to the minimum level if noise occurs
		H-pos	Adjusts horizontal position 
		V-pos	Adjusts vertical position 
		Clock Phase	Eliminates flicker and distortion ●Adjust after Clock adjustment ●Set to the minimum level if noise occurs
		Sync	PC sync signal type (H & V / SOG) ●H & V : Horizontal and Vertical sync from your PC (Most common sync format) SOG : Sync on Green sync from your PC
		Reset PC Settings	Press the OK button to reset to the default Setup settings

● Other items → p. 24 and p. 25

Restore Settings (Shipping Condition)  
Displaying PC Screen on TV

Advanced

# HDMI Functions

HDMI (high-definition multimedia interface) allows you to enjoy high-definition digital images and high-quality sound by connecting the TV and the equipment.

HDMI-compatible equipment (\*1) with an HDMI or DVI output terminal, such as a set top box, a DVD player or a game equipment, can be connected to the HDMI terminal using an HDMI compliant (fully wired) cable.

About connections, see “External Equipment” (p. 44).

## Note

- HDMI is the world’s first complete digital consumer AV interface complying with a non-compression standard.
- Audio settings can be made on the “HDMI1 Input” menu screen. (p. 25)
- Applicable audio signal sampling frequencies (2ch L.PCM): 48 kHz, 44.1 kHz, 32 kHz
- HDMI2 / 3 / 4 terminals are for digital audio signal only.
- Use with a PC is not guaranteed. Only HDMI video formats in the HDMI table (p. 48) are applicable.
- If the connected equipment has an aspect adjustment function, set the aspect ratio to “16:9”.
- These HDMI connectors are “type A”.
- These HDMI connectors are compatible with HDCP (High-Bandwidth Digital Content Protection) copyright protection.
- An equipment having no digital output terminal may be connected to the input terminal of either “COMPONENT” or “VIDEO” to receive analogue signals.
- The HDMI input terminal can be used only with the following image signals:  
480i, 480p, 576i, 576p, 720p, 1080i and 1080p. Match the output setting of the digital equipment.
- For details of the applicable HDMI signals, see p. 48.

## DVI connection

- If the external equipment has only a DVI output, connect to the HDMI1 terminal via a DVI to HDMI adapter cable (\*2).
- When the DVI to HDMI adapter cable is used, connect the audio cable to the audio input terminal (HDMI1: use COMPONENT-AUDIO terminals).

## DVI Position Settings

If the picture position is not fit to the screen during the DVI connection, adjust the position on “DVI Position Settings” in Setup Menu. The settings are memorized for each HDMI terminals and input signals.

- To make settings ➔ “How to Use Menu Functions” ① to ④ (p. 22)

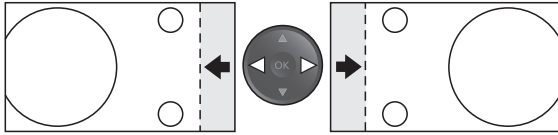
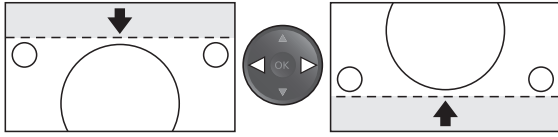
Menu	Item	Adjustments
Setup	DVI Position Settings	H-pos Adjusts horizontal position 
		V-pos Adjusts vertical position 
	Reset DVI Position Settings Press the OK button to reset to the default Setup settings	

(\*1): The HDMI logo is displayed on HDMI-compliant equipment.

(\*2): Enquire at your local digital equipment retailer shop.

# Viewing from SD Card

## (VIERA IMAGE VIEWER)

**Photo View:** Still images recorded by digital cameras will be displayed.

**Movie View:** Moving pictures recorded by digital video cameras will be played back.

- During the operation, no signals are output from any of the AV terminals. But the sound in Movie View can be output from AUDIO OUT and DIGITAL AUDIO OUT terminals.
- "Date" shows the date on which the recording was made by the digital camera or digital video camera. The file without record of the date is shown "\*\*\*/\*\*/\*\*\*\*".
- For details on SD Cards → p. 47

**To insert SD Card**

Label surface

Push until a click is heard

**To remove SD Card**

Press the centre of the card

Blue LED

- Blue LED lights while SD Card is inserted if "SD Card LED" is set to "On" in the Setup Menu (p. 25).

### Photo View

- 1 Insert the SD Card**
- 2 Select "Photo View"**
- 3 Select a folder to display the thumbnail**

(Folder view)
- 4 Select a photo from the thumbnail to be viewed**

(Thumbnail)

② access

① select

① select

② thumbnail

- The files which are not in a folder will be collected to the folder named "I".
- To display all the photos → p. 36

① select

② single view

- Slideshow → p. 36
- To sort by date or month recorded → p. 36

**To return to TV**

EXIT OR

**To return to the previous screen**

RETURN

Operation guide (Single view)

Displayed one at a time

- To display / hide the operation guide

INFO

- To the previous photo
- Rotate 90° (counter-clockwise)
- To the next photo
- Rotate 90° (clockwise)

- To return to thumbnail → RETURN

# Viewing from SD Card

## (VIERA IMAGE VIEWER)

### Slideshow

**Start Slideshow** (operate in step ④)

Select the photo for the first view

Start Slideshow

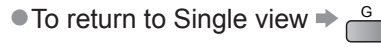

#### Note

- Slideshow is done within the thumbnail.

**Slideshow settings** (operate in Photo View Mode)

Display the menu



Select "Viewing Setup"

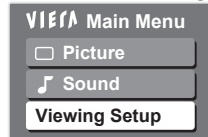

● Other Items → p. 24 - 25

Select the items and set

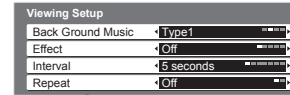

Menu	Item	Adjustments / Configurations (alternatives)
Viewing Setup	Back Ground Music	Selects the back ground music during the slideshow ( <b>Off / Type1 / Type2 / Type3</b> )
	Effect	Selects the effect for switching the photo during the slideshow ( <b>Off / Fade / Slide / Dissolve / Random</b> ) Fade : The next photo fades in gradually Slide : The next photo slides and appears from the left side Dissolve : The photo is replaced by an indefinite block unit Random : Selects each effect at random
	Interval	Selects slideshow interval ( <b>5 / 10 / 15 / 30 / 60 / 90 / 120 seconds</b> )
	Repeat	Slideshow repeat ( <b>Off / On</b> )

### To display all the photos

Display the thumbnail of all the photos in SD Card.



(Folder view)

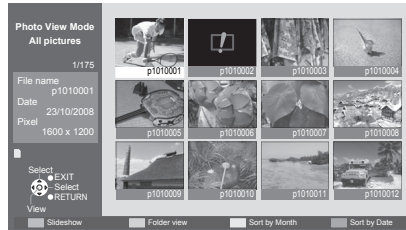
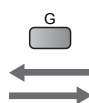

(Thumbnail - All pictures)



① select

② single view

### To sort by date or month recorded

Display the list of groups sorted by the same date or the same month.

- The group of the photos without record of the date is shown as "Unknown".

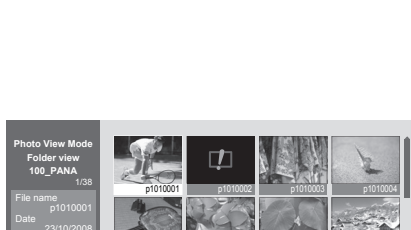

(Thumbnail)

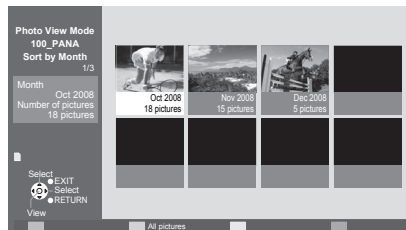

(Sort by Month)



① select

② thumbnail of the selected group



(Sort by Date)



① select

② thumbnail of the selected group



## Movie View

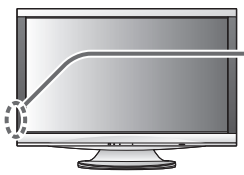

1 Insert the SD Card

2 Select "Movie View"

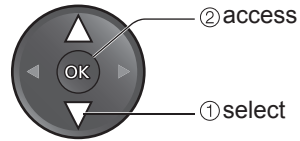
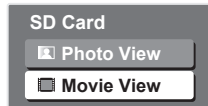

3 Select the file to be viewed

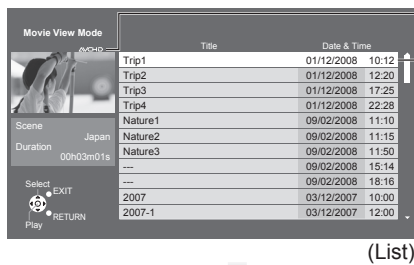

File format  
Only AVCHD or MPEG2 is supported.  
● For details → p. 47

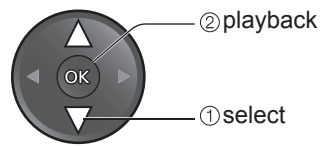

To return to TV



To return to the previous screen

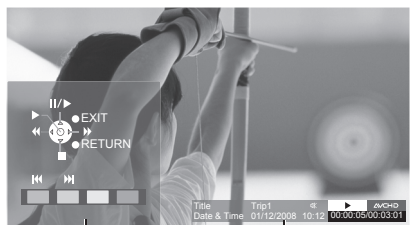

Operation guide (Playback) information banner

- To return to list → (stop)
- To change aspect ratio (only for the 4:3 movie content) → ASPECT

Playback will start

- To display the operation guide

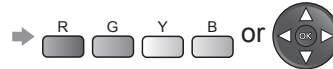

- To hide the operation guide → RETURN

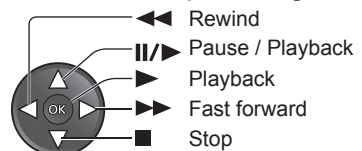

- To the previous movie → R
- To the next movie → G

## Audio Settings

You can enjoy the multi-channel sound via an amplifier connected to DIGITAL AUDIO OUT terminal.

To confirm or change the current sound status (during playback)

Display the Option menu



(Current sound status)

Change the sound (if the movie has multiple audio signals)

● It may take several seconds to change the sound.

Audio output settings (operate in step 3)

Display the menu



Select "Sound"

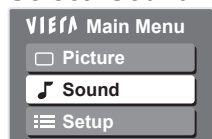

● Other items → p. 24 - 25



Select "SPDIF Selection" and set

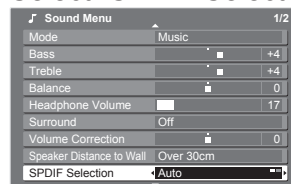

Menu	Item	Adjustments / Configurations (alternatives)
Sound	SPDIF Selection	SPDIF : A standard audio transfer file format Selects the initial setting for digital audio output signal from DIGITAL AUDIO OUT terminal (Auto / PCM) Auto: Dolby Digital is output as Dolby Digital Bitstream. MPEG is output as PCM. PCM: Digital output signal is fixed to PCM.

# VIERA Link “HDAVI Control™”

Enjoy additional HDMI interoperability with Panasonic products which have “HDAVI Control” function. This TV supports “HDAVI Control 4” function.

Connections to the equipment (DIGA Recorder, HD Video Camera, Player theatre, Amplifier, etc.) with HDMI cable allow you to interface them automatically.

These features are limited to models incorporating “HDAVI Control” and “VIERA Link”.

- Some functions are not available depending on the equipment’s version of HDAVI Control. Please confirm the connected equipment’s version of HDAVI Control.
- VIERA Link “HDAVI Control”, based on the control functions provided by HDMI which is an industry standard known as HDMI CEC (Consumer Electronics Control), is a unique function that we have developed and added. As such, its operation with other manufacturers’ equipment that supports HDMI CEC cannot be guaranteed.
- Please refer to individual manuals for the equipments. About applicable Panasonic equipment, consult your local Panasonic dealer.

## VIERA Link features and connections

### VIERA Link

Connected equipment with VIERA Link function	DIGA Recorder*1	DVD Player / Blu-ray Disc Player*1	HD Video Camera / LUMIX Camera*1	Player theatre*2	Blu-ray Disc theatre*2	Amplifier*2
<b>Features</b>						
Channel download	○*4	—	—	—	—	—
Easy playback	○	○	○	○*7	○*7	—
Power on link	○	○	○	○	○	—
Power off link	○	○	○	○	○	○
Reduce unnecessary power consumption in standby	○*5	○*5	—	—	○*5	—
Auto standby for unnecessary equipment	○*3	○*3	—	○*3*8	○*3*8	○*3
Pause Live TV programme	○*4*6	—	—	—	—	—
Direct TV Recording	○*4	—	—	—	—	—
Control the menu of the connected equipment by VIERA remote control	○*3	○*3	○*3	○*3	○*3	—
Speaker control	—	—	—	○	○	○

\*1: HDMI Connection only

\*2: HDMI and Audio out connections

\*3: available with the equipment which has “HDAVI Control 2 or later” function

\*4: available with the equipment which has “HDAVI Control 3 or later” function

\*5: available with the equipment which has “HDAVI Control 4” function

\*6: available with DIGA Recorder which has HDD

\*7: while playingback a disc

\*8: except for watching a disc

### Connection

- To use DIGA Recorder / DVD Player / Blu-ray Disc Player / HD Video Camera / LUMIX Camera

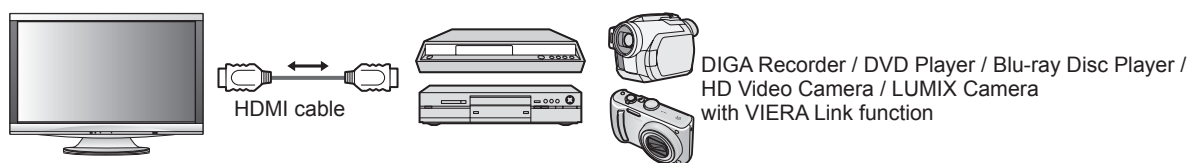

- To use Player theatre / Blu-ray Disc theatre:

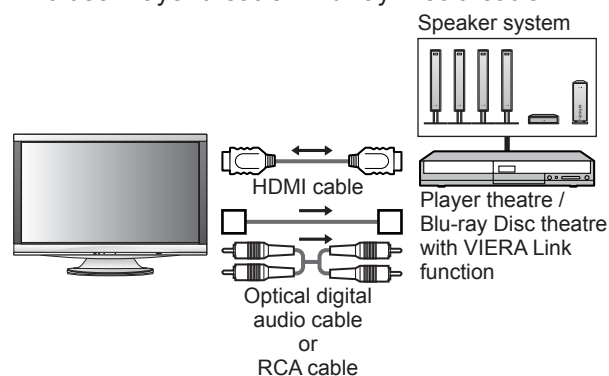

- To use Amplifier:

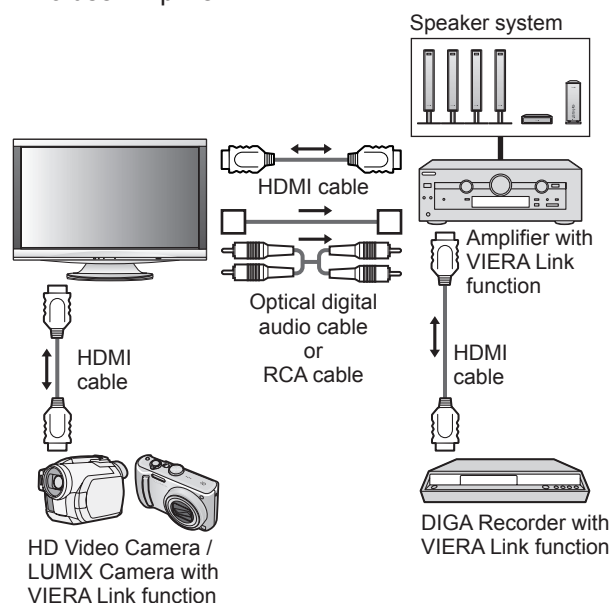

## Note

- This function may not work properly depending on the connected equipment.
- For DIGA Recorder / DVD Player / Blu-ray Disc Player / HD Video Camera / LUMIX Camera with VIERA Link function, connect to HDMI1, HDMI2, HDMI3 or HDMI4 terminal via an HDMI cable.
- For Player theatre / Blu-ray Disc theatre / Amplifier, connect to HDMI1, HDMI2, HDMI3 or HDMI4 terminal via an HDMI cable and/or either the optical digital audio cable or RCA cable for audio output from the TV.
- Use fully wired HDMI compliant cable. Non-HDMI-compliant cables cannot be utilized.  
Recommended Panasonic's HDMI cable part number:
  - RP-CDHG10 (1.0 m) • RP-CDHG15 (1.5 m) • RP-CDHG20 (2.0 m) • RP-CDHG30 (3.0 m) • RP-CDHG50 (5.0 m)

## Preparations

- Connect the equipment supporting VIERA Link.
- Set up the connected equipment. Read the manual of the equipment.
- For optimal recording, the settings of the recorder might be required. For details, read the manual of the recorder.
- Set VIERA Link On in Setup Menu ➔ "VIERA Link" (p. 25)
- Set up the TV ➔ **After connection, turn the equipment on and then switch the TV on. Select the input mode to HDMI1, HDMI2, HDMI3 or HDMI4 (p. 20), and make sure that an image is displayed correctly.**  
This setup should be done each time when the following conditions occur:
  - for the first time • when adding or reconnecting equipment • when changing setup

## Features available

### Channel download

Channel setting can be downloaded to the recorder.

### Easy playback

Automatic input switching - When the connected equipment is operated, input mode is switched automatically.

### Power on link

**Set Power on Link "On" in Setup Menu to use this function ➔ "Power on Link" (p. 25)**  
When the connected equipment starts playback or direct navigator / function menu for the equipment are activated, the TV is automatically turned on. (Only when the TV is in Standby mode.)

### Power off link

**Set Power off Link "On" in Setup Menu to use this function ➔ "Power off Link" (p. 25)**  
When the TV is set to Standby mode, the connected equipment is also automatically set to Standby.

- This function will work even if the TV enters standby mode automatically by Off Timer function or auto power standby function.

### Reduce unnecessary power consumption in standby **Standby Power Save**

**Set Standby Power Save "On" in the Setup Menu to use this function ➔ "Standby Power Save" (p. 25)**  
The power consumption in Standby mode of the connected equipment is controlled higher or lower in synchronization with the TV On / Off state to reduce the consumption.  
When the TV is set to Standby mode, the connected equipment is automatically set to Standby and the power consumption in Standby mode of the connected equipment is automatically minimized.  
When the TV is turned on, the connected equipment is still in Standby mode, but the power consumption is increased to make startup time early.

- This function is effective if the connected equipment can change the power consumption in Standby mode and is set to higher consumption.

### Auto standby for unnecessary equipment **Intelligent Auto Standby**

**Set Intelligent Auto Standby "On (With reminder)" or "On (No reminder)" in the Setup Menu to use this function ➔ "Intelligent Auto Standby" (p. 25)**  
When the TV is on, the connected equipments not in use go into Standby mode automatically to reduce the power consumption.

- If you select "On (With reminder)", the on screen message will be displayed to be noticed before working this function.

# VIERA Link “HDAVI Control™”

Features available (Using VIERA Link Menu)

## Direct TV Recording - What you see is What you record **Direct TV Rec**

Recording the current programme in DIGA Recorder immediately.

- If you connect several recorders including other manufacturers' recorders at the same time, please connect DIGA Recorder to the TV's lower HDMI terminal number.
- If you cannot operate, check the settings and the equipment ➔ “VIERA Link features and connections” (p. 38)

① Display “VIERA Link Menu”

② Select “Direct TV Rec” and start recording

VIERA Link Menu	
Pause Live TV	Start
<b>Direct TV Rec</b>	<b>Start</b>
VIERA Link Control	Recorder
Speaker Selection	Home Cinema

To stop recording  
Select “Stop” in “Direct TV Rec” and access

VIERA Link Menu	
Pause Live TV	Start
<b>Direct TV Rec</b>	<b>Stop</b>
VIERA Link Control	Recorder
Speaker Selection	Home Cinema

## Pause Live TV programme **Pause Live TV**

You can pause the live TV programme and resume later.

Live TV programme will be recorded on HDD of the connected DIGA Recorder.

- This function is available with DIGA Recorder which has HDD.
- If you connect several recorders including other manufacturers' recorders at the same time, please connect DIGA Recorder which has HDD to the TV's lower HDMI terminal number.
- If you cannot operate, check the settings and the equipment ➔ “VIERA Link features and connections” (p. 38)

Access and pause the live TV programme

① Display “VIERA Link Menu”

② Select “Pause Live TV” and pause

VIERA Link Menu	
<b>Pause Live TV</b>	<b>Start</b>
Direct TV Rec	Start
VIERA Link Control	Recorder
Speaker Selection	Home Cinema

TV picture will be paused.

- Live TV programme is recorded on HDD from where it was paused.
- Follow the operation guide to operate Pause Live TV function.

To operate Pause Live TV

- search backward
- pause
- search forward
- playback
- stop

To return to Live TV  
(stop playback of Pause Live TV / cancel pause)

Select “Yes”

Pause Live TV	
Stop Pause Live TV?	
Yes	No

## Features available (Using VIERA Link Menu)

### Operate the connected equipment with VIERA remote control **VIERA Link Control**

You can control some functions of the connected equipment with this TV remote control by pointing at the TV's signal receiver.

- If you cannot operate, check the settings and the equipment → “VIERA Link features and connections” (p. 38)
- For details of the operations for the connected equipment, read the manual of the equipment.

#### Access and operate the menu of the equipment

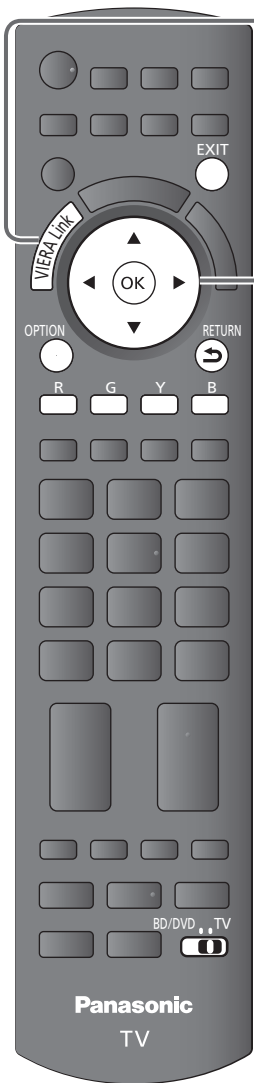

① Display “VIERA Link Menu”

② Select “VIERA Link Control”

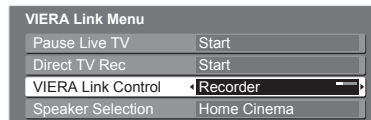

③ Select the equipment you want to access

The type of the connected equipment is displayed. Select the type of the equipment and access.

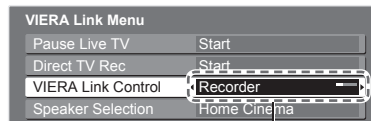

Recorder / Player / Home Cinema / Video Camera / LUMIX / Other

- “Home Cinema” means Player theatre, Blu-ray Disc theatre or Recorder theatre.
- “Other” means Tuner set top box.

**The menu of the accessed equipment**  
(Input mode will be changed automatically)

④ Operate the connected equipment

1. Switch to TV →
2. Follow the operation guide

- |  |  |                               |  |
|--|--|-------------------------------|--|
| To display the operation guide →                 |  | Store / set / access →        |  |
| Move the cursor / select the menu →              |  | Return to the previous menu → |  |
| Move the cursor / access / adjust →              |  | Exit the menu →               |  |
| When the key words are displayed on colour bar → |  |                               |  |

#### Note

- Some operations may not be available for some equipment. If so, use its own remote control.

**If several recorders or players are connected**  
You can connect up to three recorders or players at the same time.



Recorder1-3 / Player1-3

The number is given from the TV's lower HDMI terminal connected to the same type of equipment. For example, when two recorders are connected to HDMI2 and HDMI3, one connected to HDMI2 is displayed as Recorder1 and the other as Recorder2.

**If you access the invalid equipment**

When the equipment with “HDAVI Control” function is connected



Recorder1-3 / Player1-3

Type of the connected equipment is displayed. You can access the menu of the equipment. But you cannot operate it. Use its own remote control to operate the equipment.

# VIERA Link “HDAVI Control™”

Features available (Using VIERA Link Menu)

## Speaker control | Speaker Selection

You can control the theatre speaker with this TV remote control by pointing at the TV's signal receiver.

- If you cannot operate, check the settings and the equipment → “VIERA Link features and connections” (p. 38)

### Access and control the speaker volume

① Display “VIERA Link Menu”

② Select “Speaker Selection”

③ Set to “Home Cinema” or “TV”

VIERA Link Menu	
Pause Live TV	Start
Direct TV Rec	Start
VIERA Link Control	Recorder
Speaker Selection	Home Cinema

select

set

#### Home Cinema

Player theatre, Blu-ray Disc theatre or Amplifier will be automatically turned on if it is in Standby mode and the sound is from theatre speakers connected to the equipment.

- Volume up / down  
→ (Volume slide bar will be displayed when adjusting the volume of the equipment.)
- Mute →
- The sound of TV speakers is mute.
- When the equipment is turned off, TV speakers will be active.

#### TV

TV speakers are active.

### Note

- These functions may not work properly depending on the connected equipment.
- Image or sound may not be available for the first few seconds when input mode is switched.
- “HDAVI Control 4” is the newest standard (current as of December, 2008) for HDAVI Control compatible equipment. This standard is compatible with conventional HDAVI equipment.
- To confirm this TV's version of HDAVI Control → “System Information” (p. 25)

# VIERA Tools

With VIERA Tools, you can directly access to some of the useful functions of connected equipment or SD card.

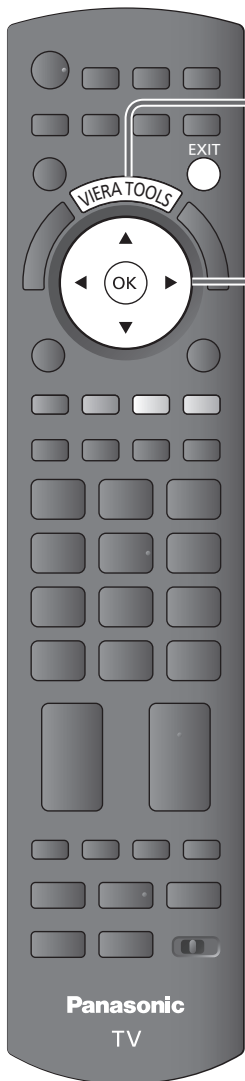

## 1 Display VIERA Tools Menu



## 2 Select a feature

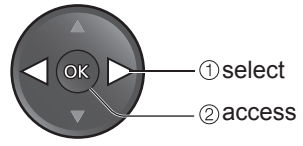

## 3 Follow the operation of each feature



VIERA Link Control

VIERA Link Control (p. 41)  
The connected device can be operated with the VIERA remote control.  
When multiple devices are connected, an indicator appears below the icon so that one device can be selected.



Pause Live TV

Pause Live TV (p. 40)  
A live TV programme can be paused and resumed later.



Direct TV Rec

Direct TV Rec (p. 40)  
What is on TV can be recorded immediately.



Speaker Selection

Speaker Control (p. 42)  
Theatre speaker can be set.



Slideshow

SD card slideshow (p. 36)  
Photo slideshow will start.



Photos

SD card photo view (p. 35)  
Photo folders are displayed.



Movies

SD card movie view (p. 37)  
The title list for SD movie image is displayed.

To return to TV



VIERA Link "HDAVI Control"™  
VIERA Tools

Advanced

# External Equipment

These diagrams show our recommendations for how to connect the TV to your various equipment. For other connections, consult the instructions for each piece of equipment, the table below, and the specifications (p. 51).

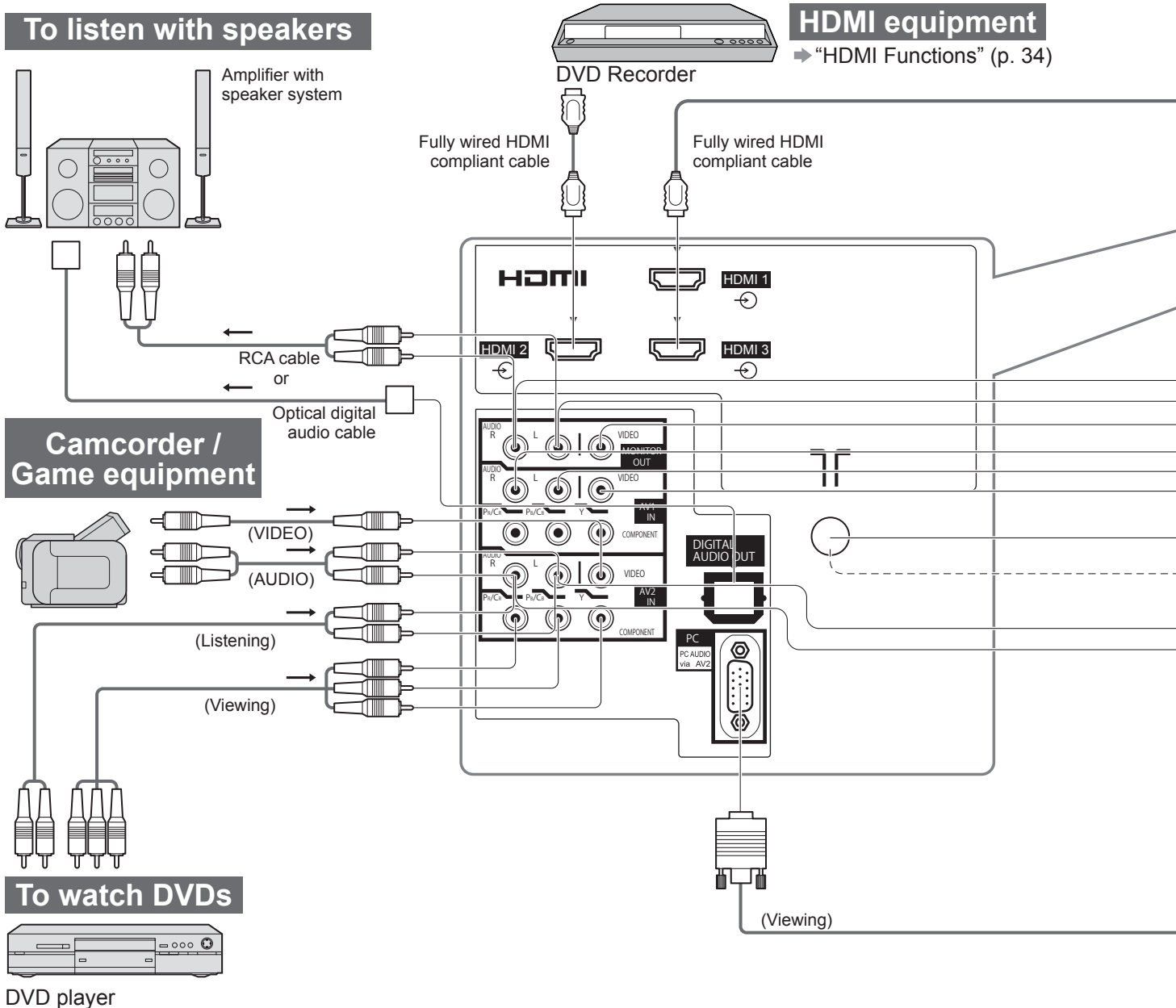

## Types of connectable equipment to each terminal

Terminal	AV1 IN	AV2 IN	MONITOR OUT
Recording / Playback (equipment)			
To record / playback videocassettes / DVDs (VCR / DVD recorder)	○	○	○
To watch DVDs (DVD player)	○	○	
To watch camcorder images (Video camera)	○	○	
To watch satellite broadcasts (Set top box)	○	○	
To play games (Game equipment)	○	○	
To use amplifier with speaker system			○
VIERA Link			

○: Recommended Connection

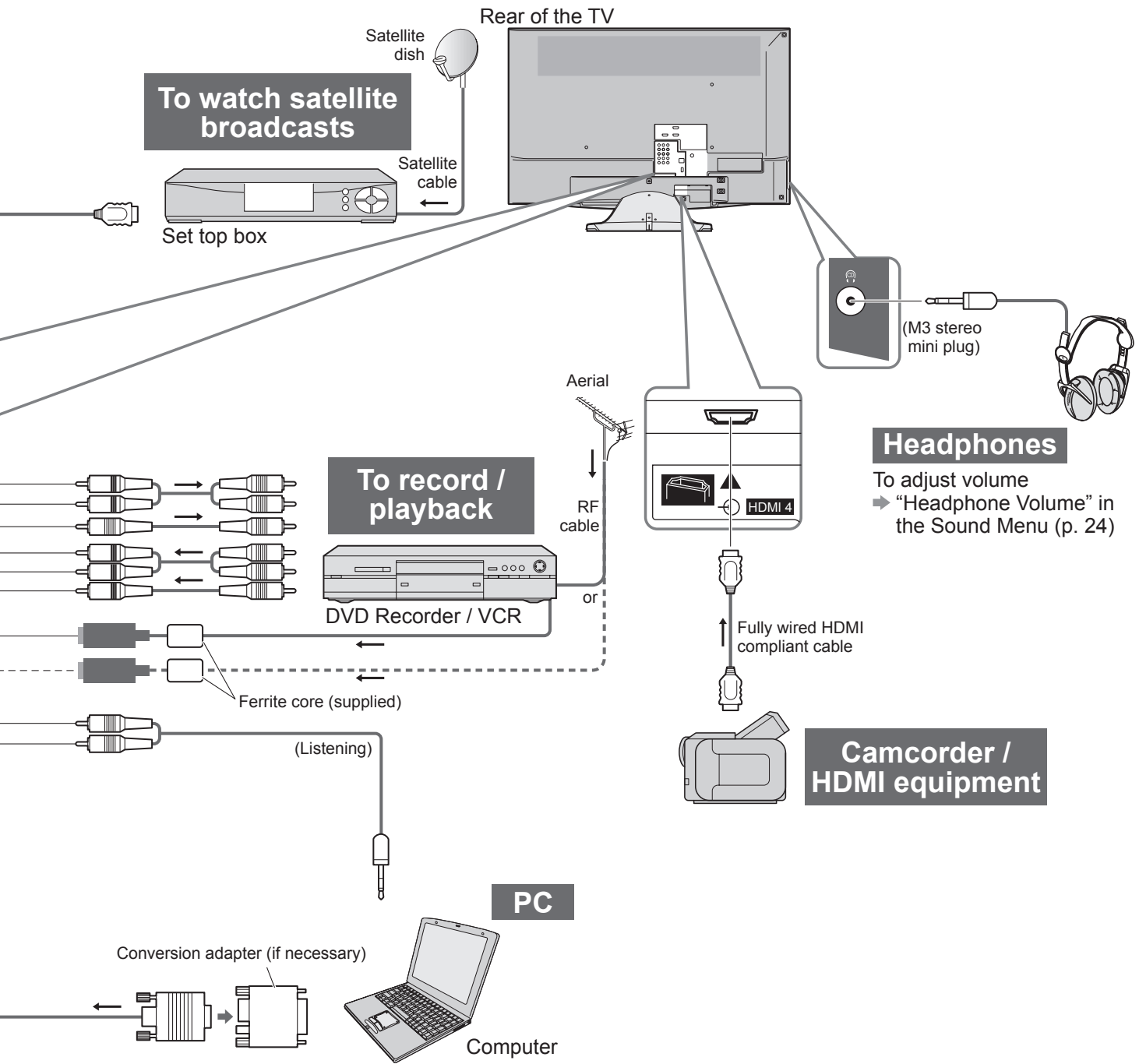

DIGITAL AUDIO OUT	HDMI			
	1	2	3	4
	○	○	○	○
	○	○	○	○
	○	○	○	○
	○	○	○	○
	○	○	○	○
	○	○	○	○

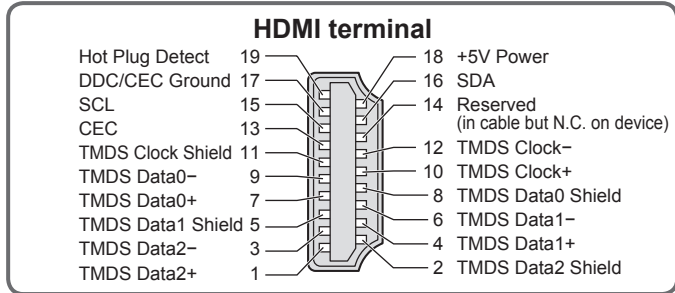

● Connect the COMPONENT or VIDEO terminal when using AV1 / AV2 IN terminals.

# Technical Information

## Channel Allocation (Analogue TV mode)

CH Display / Receive Channel			
CH 0 - CH 5	S 2 - S 10	CH 5A	CH 6 - CH 9
CH 9A	CH 10 - CH 12	S 11 - S 44	CH 20 - CH 75

## Rating (Digital TV mode)

Rating	Meaning	Rating	Meaning
-	Not classified	M	Mature
P	Pre school	MA 15+	Mature Adult 15+
C	Children	AV 15+	Adult strong Violence 15+
G	General	R	Restricted 18+
PG	Parental Guidance recommended		

## Updating the software system (Digital TV mode)

Update system software to ensure that you have latest version software.

If there is an update available, a notification banner is displayed when the channel has the update information.

- To download new software, press "OK" → Downloading (approx. 1 hour)  
If you choose not to download, press "EXIT".

### To update automatically

Set "Auto Update Search in Standby" to "On" (p. 27)

If there is a new version software being broadcast, the TV will download this automatically.

- The automatic updating sequence is carried out at 3:00 AM and 5:00 AM every morning under the following condition.  
Standby (TV turned Off with the remote control)  
Recording is not in progress.

### To update manually

Perform "System Update Search Now" (p. 27)



If there is an update available, a notification banner is displayed.

### Note











- During downloading, do not turn Off the TV or touch any buttons.  
(The TV is automatically activated after downloading is completed.)
- When the TV is switched to standby, there will be a clicking sound after a short delay. Similar clicking sounds will also occur at 3:00 AM and 5:00 AM when "Auto update Search in Standby" (p. 27) is set to "On". These sounds are normal.

## Stereo / Bilingual Sound Selection (Analogue TV mode)







 When you receive the stereo / bilingual sound system, sound output modes can be selected by pressing the **Stereo / Bilingual Sound Selection** button.

Audio Signal	STEREO	MAIN I	SUB II	MONO
Mode Indicator		I	II	

**NICAM** .....Used in New Zealand, Singapore, Hong Kong etc.

Type of broadcast	Regular broadcast (Standard Audio)	Regular + NICAM MONO I (MAIN I)	NICAM STEREO	NICAM DUAL MONO (MAIN I / SUB II)
Mode Indicator	No Indicator  	I  	  	   

**A2 (German)** .....Used in Australia, Malaysia etc.

Type of broadcast	Regular broadcast (Standard Audio)	BILINGUAL or DUAL MONO: MAIN I / SUB II	STEREO
Mode Indicator	No Indicator  	I   II	  

- If the stereo signal is poor or the receiving conditions are not optimum or if STEREO:MONO automatic switching occurs, it is recommended you switch from STEREO to MONO.
- Even when the contents of the receiving signal undergo changes, selection mode is kept intact.
- When the receiving conditions deteriorate, listening will be easier if the mode is set to the MONO position, using the stereo / bilingual sound selection button.
- DUAL, also known as DUAL MONO or as BILINGUAL is not currently transmitted in some countries.

## SD Card

### Cautions in handling SD Card

- Do not remove the card while the TV is accessing data (this can damage card or TV).
- Do not touch the pins on the back of the card.
- Do not subject the card to a high pressure or impact.
- Insert the card in the correct direction (otherwise, card may be damaged).
- Electrical interference, static electricity, or erroneous operation may damage the data or card.
- Back up the recorded data at regular intervals in case of deteriorated or damaged data or erratic operation of the TV. (Panasonic is not liable for any deterioration or damage of recorded data.)

### Data format for Card browsing

Photo : Still images recorded with digital still cameras compatible with JPEG files of DCF\* and EXIF standards

Data format - Baseline JPEG (Sub-sampling 4:4:4, 4:2:2 or 4:2:0)

Max. number of files - 9,999

Image resolution - 8 × 8 to 30,719 × 17,279 pixels

Movie : SD-Video Standard Ver. 1.2 [MPEG-2 (PS format)] and AVCHD Standard compatible files with an audio format that is either MPEG-1/Layer-2 format or Dolby Digital format

(AVCHD files recorded with vertical frequency 50Hz are applicable. A modified data with a PC may not be displayed correctly.)

- Compliant card type (maximum capacity): SDHC Card (32 GB), SD Card (2 GB) and miniSD Card (2 GB) (requiring miniSD adapter)
- If miniSD Card is used, insert / remove it together with the adapter.
- Check the latest information on the card type at the following website. (English only)  
<http://panasonic.co.jp/pavc/global/cs/>

\*DCF (Design rule for camera file system): Unified standard established by Japan Electronics and Information Technology Industries Association (JEITA).

### Note

- Format the card with the recording equipment.
- The picture may not appear correctly on this TV depending on the recording equipment used.
- Display may take some time when there are many files and folders.
- This function cannot display Motion JPEG and still image not JPEG formatted (i.e. TIFF, BMP).
- A data modified with a PC may not be displayed.
- Images imported from a PC must be compatible with EXIF (Exchangeable Image File) 2.0, 2.1, and 2.2.
- Partly degraded files might be displayed at a reduced resolution.
- All “.JPG” extension datas in the card will be read in Photo View Mode.
- The folder and file names may be different depending on the digital camera used.
- Do not use two-byte characters or other special codes.
- The card may become unusable with this TV if the file or folder names are changed.

### On screen messages

Message	Meaning / Action
Cannot read file	<ul style="list-style-type: none"> <li>● The file is broken or unreadable.</li> <li>● The TV does not support the format. (For the applicable formats and data, see above.)</li> </ul>
Please confirm the SD card is OK	<ul style="list-style-type: none"> <li>● The inserted SD card has a problem.</li> </ul>
No SD card inserted	<ul style="list-style-type: none"> <li>● Insert a SD Card.</li> </ul>
No valid file to play	<ul style="list-style-type: none"> <li>● The card has no data.</li> </ul>
Over 9999 pictures found. (max. is 9999)	<ul style="list-style-type: none"> <li>● Maximum valid number of photos is 9,999.</li> </ul>
This operation is not possible	<ul style="list-style-type: none"> <li>● Your operation is not available.</li> </ul>

# Technical Information

## PC connection

A PC may be connected to this TV so that the PC screen is displayed and sound is heard from the TV.

- PC signals that can be inputted: Horizontal scanning frequency 31 to 69 kHz; vertical scanning frequency 59 to 86 Hz (more than 1,024 signal lines could result in incorrect display of the image).
- A PC adapter is not necessary for the DOS/V-compliant D-sub 15-pin connector.

### Note

- Some PC models cannot be connected to this TV.
- When using PC, set the colour display quality of PC to the highest position.
- For details of the applicable PC signals, see below.
- Max. display resolution

Aspect	4:3	1,440 × 1,080 pixels
	16:9	1,920 × 1,080 pixels

- D-sub 15-pin connector signal

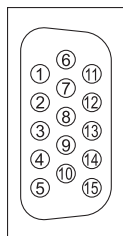

Pin No.	Signal Name	Pin No.	Signal Name	Pin No.	Signal Name
①	R	⑥	GND (Ground)	⑪	NC (not connected)
②	G	⑦	GND (Ground)	⑫	NC (not connected)
③	B	⑧	GND (Ground)	⑬	HD
④	NC (not connected)	⑨	NC (not connected)	⑭	VD
⑤	GND (Ground)	⑩	GND (Ground)	⑮	NC (not connected)

## Input signal that can be displayed

### COMPONENT (Y, P<sub>B</sub>/C<sub>B</sub>, P<sub>R</sub>/C<sub>R</sub>), HDMI

\* Mark: Applicable input signal

Signal name	COMPONENT	HDMI
525 (480) / 60i	*	*
525 (480) / 60p	*	*
625 (576) / 50i	*	*
625 (576) / 50p	*	*
750 (720) / 60p	*	*
750 (720) / 50p	*	*
1,125 (1,080) / 60i	*	*
1,125 (1,080) / 50i	*	*
1,125 (1,080) / 60p		*
1,125 (1,080) / 50p		*
1,125 (1,080) / 24p		*

### PC (D-sub 15P)

Signal name	Horizontal frequency (kHz)	Vertical frequency (Hz)
640 × 400 @70 Hz	31.47	70.07
640 × 480 @60 Hz	31.47	59.94
640 × 480 @75 Hz	37.50	75.00
800 × 600 @60 Hz	37.88	60.32
800 × 600 @75 Hz	46.88	75.00
800 × 600 @85 Hz	53.67	85.06
852 × 480 @60 Hz	31.44	59.89
1,024 × 768 @60 Hz	48.36	60.00
1,024 × 768 @70 Hz	56.48	70.07
1,024 × 768 @75 Hz	60.02	75.03
1,024 × 768 @85 Hz	68.68	85.00
1,280 × 1,024 @60 Hz	63.98	60.02
1,280 × 768 @60 Hz	47.70	60.00
1,366 × 768 @60 Hz	48.39	60.04
Macintosh13" (640 × 480)	35.00	66.67
Macintosh16" (832 × 624)	49.73	74.55
Macintosh21" (1,152 × 870)	68.68	75.06

### Note

- Signals other than above may not be displayed properly.
- The above signals are reformatted for optimal viewing on your display.
- Applicable input signal for PC is basically compatible to VESA standard timing.
- PC signal is magnified or compressed for display, so that it may not be possible to show fine detail with sufficient clarity.

# FAQs

Before requesting service or assistance, please follow these simple guides to resolve the problem. If the problem still persists, please contact your local Panasonic dealer for assistance.

## White spots or shadow images (noise)

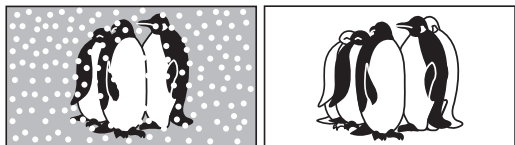

- Check the position, direction, and connection of the aerial.
- Keep the space between the TV and RF cable.
- Install the Ferrite core for using RF cable. (p. 10)

## Neither image nor sound is produced

- Is the TV in "AV mode"?
- Is the mains lead plugged into the socket outlet?
- Is the TV turned On?
- Check Picture Menu (p. 24) and volume.

## An error message appears

- Follow the message's instructions.
- If the problem persists, contact your local Panasonic dealer.

## The LCD panel moves slightly when it is pushed with a finger Clattered sound might be heard

- There are some looseness around the panel to prevent the damage to the panel. The panel might move slightly when it is pushed with a finger, and clattered sound might be heard. This is not a malfunction.

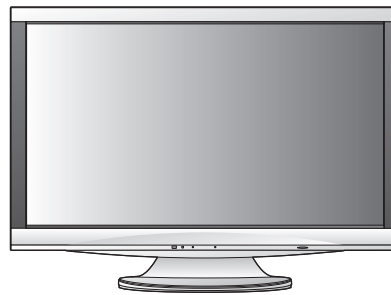

## There may be red spots, blue spots, green spots and black spots on the screen

- An image on a LCD or Plasma TV screen is created by many small groups of dots known as pixels (which is similar to the image in a newspaper). It also naturally follows that higher panel resolutions contain more pixels. To create a colour image, each pixel consists of three tiny coloured dots (known as sub-pixels), one each of red, green and blue. Each one of these dots is precisely controlled by the electronics of the TV to produce the picture.

Whilst Panasonic maintains the highest standards in manufacturing technology and processes in the construction of these panels, there are a number of allowable pixel/sub-pixel failures that still allow the panel to be defined as a good panel. It is not possible to guarantee absolutely no pixel loss.

	Problem	Actions
Screen	Chaotic image, noisy	<ul style="list-style-type: none"> <li>● Change the setting of "P-NR" in the Picture Menu (to remove noise). (p. 24)</li> <li>● Check nearby electrical products (car, motorcycle, fluorescent lamp).</li> </ul>
	No image can be displayed	<ul style="list-style-type: none"> <li>● Is "Colour" or "Contrast" in the Picture Menu set to the minimum? (p. 24)</li> </ul>
	Blurry or distorted image (no sound or low volume)	<ul style="list-style-type: none"> <li>● Reset channel. (p. 32)</li> </ul>
	Unusual image is displayed	<ul style="list-style-type: none"> <li>● Turn off the TV with Mains power On / Off switch, then turn it on again.</li> </ul>
	"Shop" appears on screen at switch on	<ul style="list-style-type: none"> <li>● "Shop" was selected in "Auto Tuning" (p. 11). Reset all settings in "Shipping Condition" (p. 32), then select "Home" in "Auto Tuning" (p. 11).</li> </ul>
Sound	No sound is produced	<ul style="list-style-type: none"> <li>● Is "Sound Mute" active? (p. 9)</li> <li>● Is the volume set to the minimum?</li> </ul>
	Sound level is low or sound is distorted	<ul style="list-style-type: none"> <li>● Sound signal reception may be deteriorated.</li> <li>● Set "MPX" (p. 24) in the Sound Menu to "Mono".</li> </ul>

# FAQs

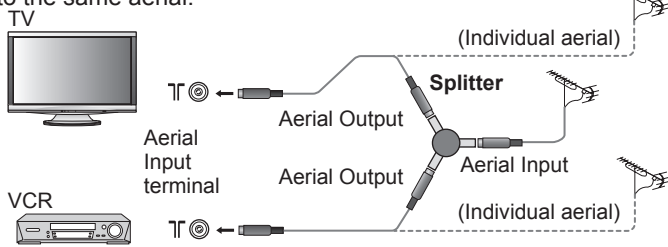
	Problem	Actions
HDMI	Sound is unusual	<ul style="list-style-type: none"> <li>● Set the sound setting of the connected equipment to "2ch L.PCM".</li> <li>● Check the "HDMI1 Input" setting in the Sound Menu. (p. 25)</li> <li>● If digital sound connection has a problem, select analogue sound connection. (p. 34)</li> </ul>
	Pictures from external equipment are unusual when the equipment is connected via HDMI	<ul style="list-style-type: none"> <li>● Is the HDMI cable connected properly? (p. 44)</li> <li>● Turn Off the TV and equipment, then turn them On again.</li> <li>● Check an input signal from the equipment. (p. 48)</li> <li>● Use an equipment compliant with EIA/CEA-861/861B.</li> </ul>
Digital TV	<ul style="list-style-type: none"> <li>● Digital TV reception technology requires high quality, robust DTV signals which in some domestic aerial installations, may be relatively poor despite good analogue reception.</li> </ul>	
	Aerial connection when using DTV and VCR / DVD Recorder	<ul style="list-style-type: none"> <li>● To maintain optimum signal quality from TV aerial, use a TV aerial splitter (as illustrated) when connecting two or more equipments to the same aerial.</li> </ul> 
	After Digital TV Auto Tuning only some or no services are found	<ul style="list-style-type: none"> <li>● Check to ensure your area is covered by DVB transmissions.</li> <li>● Check that the aerial and antenna cable are designed for DVB. For your safety, the aerial and cable should be inspected / installed by a licenced installer that should comply with Australian Standard AS1417.1. Note: If you live within 5-10 Km of DVB transmission towers, a combined VHF / UHF aerial should be adequate. Outside this area, separate VHF and UHF aeriels provide superior reception performance.</li> <li>● If you live in a unit or apartment, check to ensure the Master Antenna TV (MATV) system is designed for analogue and DVB-T reception. Please consult your body corporate.</li> </ul>
	Picture regularly breaks up on some programmes, or "No Signal" message	<ul style="list-style-type: none"> <li>● Check "Signal Condition". (p. 31) If "Signal Quality" or "Signal Strength" are displayed in red or constantly changing, check aerial. If problem persists consult your local TV aerial installer.</li> <li>● Check that the aerial and antenna cable are designed for DVB. For your safety, the aerial and cable should be inspected / installed by a licenced installer that should comply with Australian Standard AS1417.1.</li> <li>● Interference (known as impulse noise) from household appliances such as light switches, fridges etc may cause picture break up and / or audio distortion. Use high quality quad shielded coaxial cable fly lead between TV and antenna wall socket to minimise impulse noise pickup. If problem persists consult your local TV aerial installer.</li> <li>● When "No Signal" message is displayed check TV aerial connection.</li> <li>● The received signal may be too weak to allow the TV to reliably lock to the desired "No Signal" programme to generate a stable picture. Repeat the tuning procedure (p. 31). If problem persists consult your local TV aerial installer.</li> </ul>
	Picture very infrequently breaks up on some or all programmes	<ul style="list-style-type: none"> <li>● Electrical atmospheric interference caused by local or distant lighting storms or heavy rain with wind in "leafy" locations may cause pictures to break up and audio to mute or distort momentarily.</li> <li>● Impulse noise interference from an infrequently used electrical appliance, or a passing vehicle or lawn mower with a "noisy" ignition system.</li> </ul>
Other	TV takes so long to turn on	<ul style="list-style-type: none"> <li>● Like your computer, the TV has to run a number of diagnostic and software checks before it can display any programmes.</li> </ul>
	The programme cannot be changed	<ul style="list-style-type: none"> <li>● Is the TV in Teletext mode? (p. 18)</li> </ul>
	The programme cannot be selected	<ul style="list-style-type: none"> <li>● Is the programme skipped? (p. 29)</li> </ul>
	TV goes into "Standby mode"	<ul style="list-style-type: none"> <li>● Off Timer function is activated.</li> <li>● The TV enters "Standby mode" about 30 mins. after analogue broadcasting ends.</li> </ul>
	The remote control does not work	<ul style="list-style-type: none"> <li>● Are the batteries installed correctly? (p. 7)</li> <li>● Has the TV been switched On?</li> </ul>

# Specifications

			TH-L37V10A		
Power	Power rating	AC 220 - 240 V, 50 / 60 Hz 0.80 A			
	Normal (Home) mode	111 W			
	Standby condition	0.3 W			
Display panel	Aspect Ratio	16:9			
	Visible screen size	94 cm (diagonal) 819 mm (W) × 460 mm (H)			
	Number of pixels	2,073,600 (1,920 (W) × 1,080 (H))			
Sound	Speaker	160 mm × 42 mm × 2 pcs, 8 Ω			
	Audio Output	20 W (10 W + 10 W), 10% THD			
	Headphones	M3 (3.5 mm) stereo mini Jack × 1			
PC signals	VGA, SVGA, WVGA, XGA SXGA, WXGA ..... (compressed) Horizontal scanning frequency 31 - 69 kHz Vertical scanning frequency 59 - 86 Hz				
Receiving Systems / Band name	PAL B/G	Reception of Off air broadcasts			
	DVB-T	7 MHz VHF / UHF (Australia) free-to-air TV broadcast reception			
	PAL 60 Hz M.NTSC NTSC	Playback of NTSC tape from some PAL Video recorders (VCR) Playback from M. NTSC Video recorders (VCR) Playback from NTSC Video recorders (VCR)			
Aerial - Rear	VHF / UHF				
Operating Conditions	Temperature : 0 °C - 35 °C Humidity : 20 % - 80 % RH (non-condensing)				
Connection Terminals	AV1 Input	AUDIO L - R	RCA PIN Type × 2	0.5 V[rms]	
		VIDEO	RCA PIN Type × 1	1.0 V[p-p] (75 Ω)	
		COMPONENT	Y P <sub>B</sub> /C <sub>B</sub> , P <sub>R</sub> /C <sub>R</sub>	1.0 V[p-p] (including synchronization) ±0.35 V[p-p]	
	AV2 Input	AUDIO L - R	RCA PIN Type × 2	0.5 V[rms]	
		VIDEO	RCA PIN Type × 1	1.0 V[p-p] (75 Ω)	
		COMPONENT	Y P <sub>B</sub> /C <sub>B</sub> , P <sub>R</sub> /C <sub>R</sub>	1.0 V[p-p] (including synchronization) ±0.35 V[p-p]	
	Monitor Output	AUDIO L - R	RCA PIN Type × 2	0.5 V[rms] (high impedance)	
		VIDEO	RCA PIN Type × 1	1.0 V[p-p] (75 Ω)	
	Others	HDMI1 - 4 Input	TYPE A Connectors	This TV supports "HDAVI control 4" function.	
		PC Input	HIGH-DENSITY D-SUB 15PIN	R, G, B/0.7 V[p-p] (75 Ω) HD, VD/TTL Level 2.0 - 5.0 V[p-p] (high impedance)	
		DIGITAL AUDIO OUT	PCM / Dolby Digital, Fiber optic		
		Card slot	SD Card slot × 1		
Dimensions ( W × H × D )	896 mm × 648 mm × 287 mm (With Pedestal) 896 mm × 578 mm × 67 mm (TV only)				
Mass	18.0 kg Net (With Pedestal) 15.0 kg Net (TV only)				

## Note

● Design and Specifications are subject to change without notice. Mass and Dimensions shown are approximate.

## WARRANTY - Australia only

1. The product is warranted for 12 months from the date of purchase. Subject to the conditions of this warranty Panasonic or its Authorised Service Centre will perform necessary service on the product without charge for parts or labour if, in the opinion of Panasonic, the product is found to be faulty within the warranty period.
  2. This warranty only applies to Panasonic products purchased in Australia and sold by Panasonic Australia or its Authorised Distributors or Dealers and only where the products are used and serviced within Australia or its territories. Warranty cover only applies to service carried out by a Panasonic Authorised Service Centre and only if valid proof of purchase is presented when warranty service is requested.
  3. This warranty only applies if the product has been installed and used in accordance with the manufacturer's recommendations (as noted in the operating instructions) under normal use and reasonable care (in the opinion of Panasonic). The warranty covers normal domestic use only and does not cover damage, malfunction or failure resulting from use of incorrect voltages, incorrect installation, accident, misuse, neglect, build-up of dirt or dust, abuse, maladjustment of customer controls, mains supply problems, thunderstorm activity, infestation by insects or vermin, tampering or repair by unauthorised persons (including unauthorised alterations), exposure to abnormally corrosive conditions or any foreign object or matter having entered the product.
  4. This warranty does not cover the following items unless the fault or defect existed at the time of purchase:

(a) Video or Audio Tapes	(d) Cabinet Parts	(g) Microwave Oven cook plates.
(b) Video or Audio Heads and Stylii resulting from wear and tear in normal use	(e) User replaceable Batteries	(h) Kneader mounting shaft unit (bread bakery)
(c) Shaver Heads or Cutters	(f) Thermal Paper, Toner/Ink Cartridges, Drums, Developer, Film (Ink/Ribbon), Film Cartridge, Printer Heads	
  5. If warranty service is required you should:
    - Telephone Panasonic's Customer Care Centre on 132600 or visit our website and use the Service Centre Locator for the name/address of the nearest Authorised Service Centre.
    - Send or bring the product to a Panasonic Authorised Service Centre together with your proof of purchase receipt as a proof of purchase date. Please note that freight and insurance to and / or from your nearest Authorised Service Centre must be arranged by you.
    - Note that home or pick-up/delivery service is available for the following products in the major metropolitan areas of Australia or the normal operating areas of the nearest Authorised Service Centres:

(a) Picture tube (CRT) based Television Receivers (screen sizes greater than 66cm); Rear Projection TV's; Plasma/LCD televisions / displays (screen size greater than 103 cm)	(b) Convection/Combination Microwave Ovens
	(c) Whiteboard (except portable type)
  6. The warranties hereby conferred do not extend to, and exclude, any costs associated with the installation, de-installation or re-installation of a product, including costs related to the mounting, de-mounting or remounting of any screen, (and any other ancillary activities), delivery, handling, freighting, transportation or insurance of the product or any part thereof or replacement of and do not extend to, and exclude, any damage or loss occurring by reason of, during, associated with, or related to such installation, de-installation, re-installation or transit.
- Panasonic Authorised Service Centres are located in major metropolitan areas and most regional centres of Australia, however, coverage will vary dependant on product. For advice on exact Authorised Service Centre locations for your product, please telephone our Customer Care Centre on 132600 or visit our website and use the Service Centre Locator.
- Unless otherwise specified to the consumer the benefits conferred by this express warranty are additional to all other conditions, warranties, guarantees, rights and remedies expressed or implied by the *Trade Practices Act 1974* and similar consumer protection provisions contained in legislation of the States and Territories and all other obligations and liabilities on the part of the manufacturer or supplier and nothing contained herein shall restrict or modify such rights, remedies, obligations or liabilities.
- November 2005*

**THIS WARRANTY CARD AND THE PURCHASE DOCKET (OR SIMILAR PROOF OF PURCHASE)  
SHOULD BE RETAINED BY THE CUSTOMER AT ALL TIMES**

**If you require assistance regarding warranty conditions or any other enquiries,  
please visit the **Panasonic Australia** website  
**www.panasonic.com.au** or by phone on 132 600  
If phoning in, please ensure you have your operating instructions available.**

### **Panasonic Australia Pty. Limited**

ACN 001 592 187 ABN 83 001 592 187

Locked Bag 505, Frenchs Forest, NSW 2086

[www.panasonic.com.au](http://www.panasonic.com.au)

PRO-031-F01 Issue: 3.0

23-11-2005

## Customer's Record

The model number and serial number of this product may be found on its rear panel. You should note this serial number in the space provided below and retain this book, plus your purchase receipt, as a permanent record of your purchase to aid in identification in the event of theft or loss, and for Warranty Service purposes.

Model Number \_\_\_\_\_

Serial Number \_\_\_\_\_

Panasonic Corporation

Web Site: <http://panasonic.net/>

© Panasonic Corporation 2009

Printed in Malaysia  
PBS0709H1