

Panasonic

Colour CCTV Camera Operating Instructions

Model Nos. **WV-CS570**
WV-CS574E

ENGLISH

DEUTSCH

FRANÇAIS

ESPAÑOL

ITALIANO

РУССКИЙ



Before attempting to connect or operate this product,
please read these instructions carefully and save this manual for future use.

ENGLISH VERSION

We declare under our sole responsibility that the product to which this declaration relates is in conformity with the standards or other normative documents following the provisions of Directives EEC/73/23 and EEC/89/336.

Wij verklaren als enige aansprakelijke, dat het product waarop deze verklaring betrekking heeft, voldoet aan de volgende normen of andere normatieve documenten, overeenkomstig de bepalingen van Richtlijn 73/23/EEC en 89/336/EEC.

Vi erklærer os eneansvarlige for, at dette produkt, som denne deklaration omhandler, er i overensstemmelse med standarder eller andre normative dokumenter i følge bestemmelserne i direktivene 73/23/EEC og 89/336/EEC.

Vi deklarerar härmed vårt fulla ansvar för att den produkt till vilken denna deklaration hänvisar är i överensstämmelse med standarddokument, eller andra normativa dokument som framställs i EEC-direktiv nr. 73/23 och 89/336.

Ilmoitamme yksinomaisella vastuullamme, että tuote, jota tämä ilmoitus koskee, noudattaa seuraavia standardeja tai muita ohjeellisia asiakirjoja, jotka noudattavat direktiivien 73/23/EEC ja 89/336/EEC säädöksiä.

Vi erklærer oss alene ansvarlige for at produktet som denne erklæringen gjelder for, er i overensstemmelse med følgende normer eller andre normgivende dokumenter som følger bestemmelserne i direktivene 73/23/EEC og 89/336/EEC.

CAUTION:

Before attempting to connect or operate this product, please read the label on the surface of the unit.

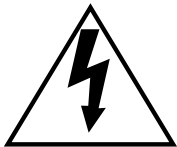
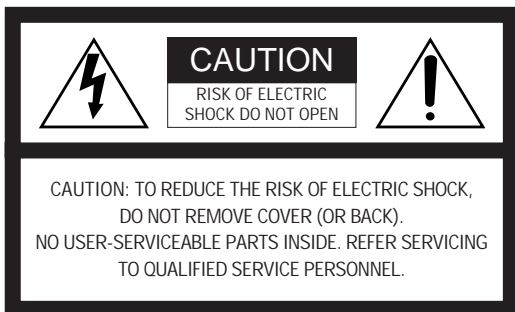

The lightning flash with arrowhead symbol, within an equilateral triangle, is intended to alert the user to the presence of uninsulated "dangerous voltage" within the product's enclosure that may be of sufficient magnitude to constitute a risk of electric shock to persons.



The exclamation point within an equilateral triangle is intended to alert the user to the presence of important operating and maintenance (servicing) instructions in the literature accompanying the appliance.



Turn the power off at the mains to disconnect the main power for all unit.

FOR YOUR SAFETY PLEASE READ THE FOLLOWING TEXT CAREFULLY.

WARNING: This apparatus must be earthed.

IMPORTANT

The wires in this mains lead are coloured in accordance with the following code.

Green-and-yellow: Earth
Blue: Neutral
Brown: Live

As the colours of the wire in the mains lead of this appliance may not correspond with the coloured markings identifying the terminals in your plug, proceed as follows.

The wire which is coloured **green-and-yellow** must be connected to the terminal in the plug which is marked with the letter **E** or by the earth symbol \perp or coloured **green** or **green-and-yellow**.

The wire which is coloured **blue** must be connected to the terminal in the plug which is marked with the letter **N** or coloured **black**.

The wire which is coloured **brown** must be connected to the terminal in the plug which is marked with the letter **L** or coloured **red**.

The serial number of this product may be found on the surface of the unit.

You should note the serial number of this unit in the space provided and retain this instruction as a permanent record of your purchase to aid identification in the event of theft.

Model No. WV-CS570/CS574E

Serial No. _____

WARNING:

To prevent fire or electric shock hazard, do not expose this appliance to rain or moisture. The apparatus shall not be exposed to dripping or splashing and that no objects filled with liquids, such as vases, shall be placed on the apparatus.

CAUTION:

An ALL-POLE MAINS SWITCH with a contact separation of at least 3 mm in each pole shall be incorporated in the electrical installation of the building.

IMPORTANT SAFETY INSTRUCTIONS

- 1) Read these instructions.
- 2) Keep these instructions.
- 3) Heed all warnings.
- 4) Follow all instructions.
- 5) Do not use this apparatus near water.
- 6) Clean only with dry cloth.
- 7) Do not block any ventilation openings. Install in accordance with the manufacturer's instructions.
- 8) Do not use near any heat sources such as radiators, heat registers, stoves, or other apparatus (including amplifiers) that produce heat.
- 9) Do not defeat the safety purpose of the polarized or grounding-type plug. A polarized plug has two blades with one wider than the other. A grounding-type plug has two blades and a third grounding prong. The wide blade or the third prong are provided for your safety. If the provided plug does not fit into your outlet, consult an electrician for replacement of the obsolete outlet.
- 10) Protect the power cord from being walked on or pinched particularly at plugs, convenience receptacles and the points where they exit from the apparatus.
- 11) Only use attachments/accessories specified by the manufacturer.
- 12) Use only with the cart, stand, tripod, bracket, or table specified by the manufacturer, or sold with the apparatus. When a cart is used, use caution when moving the cart/apparatus combination to avoid injury from tip-overs.



- 13) Unplug this apparatus during lightning storms or when unused for long periods of time.
- 14) Refer all servicing to qualified service personnel. Servicing is required when the apparatus has been damaged in any way, such as power-supply cord or plug is damaged, liquid has been spilled or objects fallen into the apparatus, the apparatus has been exposed to rain or moisture, does not operate normally, or has been dropped.

LIMITATION OF LIABILITY

THIS PUBLICATION IS PROVIDED "AS IS" WITHOUT WARRANTY OF ANY KIND, EITHER EXPRESS OR IMPLIED, INCLUDING BUT NOT LIMITED TO, THE IMPLIED WARRANTIES OF MERCHANTABILITY, FITNESS FOR ANY PARTICULAR PURPOSE, OR NON-INFRINGEMENT OF THE THIRD PARTY'S RIGHT.

THIS PUBLICATION COULD INCLUDE TECHNICAL INACCURACIES OR TYPOGRAPHICAL ERRORS. CHANGES ARE ADDED TO THE INFORMATION HEREIN, AT ANY TIME, FOR THE IMPROVEMENTS OF THIS PUBLICATION AND/OR THE CORRESPONDING PRODUCT(S).

DISCLAIMER OF WARRANTY

IN NO EVENT SHALL MATSUSHITA ELECTRIC INDUSTRIAL CO., LTD. BE LIABLE TO ANY PARTY OR ANY PERSON, EXCEPT FOR REPLACEMENT OR REASONABLE MAINTENANCE OF THE PRODUCT, FOR THE CASES, INCLUDING BUT NOT LIMITED TO BELOW:

- (1) ANY DAMAGE AND LOSS, INCLUDING WITHOUT LIMITATION, DIRECT OR INDIRECT, SPECIAL, CONSEQUENTIAL OR EXEMPLARY, ARISING OUT OF OR RELATING TO THE PRODUCT;
- (2) PERSONAL INJURY OR ANY DAMAGE CAUSED BY INAPPROPRIATE USE OR NEGLIGENT OPERATION OF THE USER;
- (3) UNAUTHORIZED DISASSEMBLE, REPAIR OR MODIFICATION OF THE PRODUCT BY THE USER;
- (4) INCONVENIENCE OR ANY LOSS ARISING WHEN IMAGES ARE NOT DISPLAYED, DUE TO ANY REASON OR CAUSE INCLUDING ANY FAILURE OR PROBLEM OF THE PRODUCT;
- (5) ANY PROBLEM, CONSEQUENTIAL INCONVENIENCE, OR LOSS OR DAMAGE, ARISING OUT OF THE SYSTEM COMBINED BY THE DEVICES OF THIRD PARTY.
- (6) ANY CLAIM OR ACTION FOR DAMAGES, BROUGHT BY ANY PERSON OR ORGANIZATION BEING PHOTOGENIC SUBJECT, DUE TO VIOLATION OF PRIVACY WITH THE RESULT OF THAT SURVEILLANCE-CAMERA'S PICTURE, INCLUDING SAVED DATA, FOR SOME REASON, BECOMES PUBLIC OR IS USED FOR THE PURPOSE OTHER THAN SURVEILLANCE.
- (7) ANY PROBLEM, CONSEQUENTIAL INCONVENIENCE, ANY LOSS OR DAMAGE, ARISING OUT OF THE IMPROPER DETECTION OR SLIP-UP IN DETECTION BY VMD (VIDEO MOTION DETECTOR) FUNCTION OF THE PRODUCT.

FEATURES

This Colour CCTV Camera is a video surveillance device that incorporates a 1/4-type {1/4"} CCD, a 22x zoom lens, preset and pan and tilt capabilities in a dome configuration. It also has the following features.

■ New DSP for High Sensitivity

A new noise reduction system lowers minimum illuminance to 1.0 lx {0.1 footcandle} in the colour mode.

■ Digital Flip

Normally, a camera needs to stop when it points straight down during a tilt operation. With digital flip, however, the camera is able to tilt from 0° to 180° in a single motion. This makes it possible to track subjects passing directly under the camera more smoothly.

Digital Flip Operation

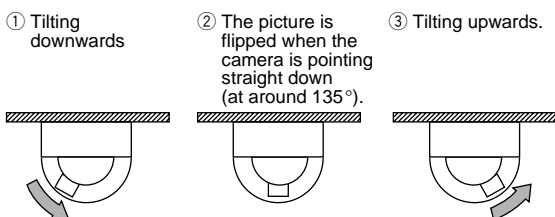

Digital flip is performed only when the system controller joystick is held downwards.

■ Privacy Zone Function

The privacy zone function makes it possible to mask specific areas of the scene from view.

■ Patrol Function

The patrol function remembers manual camera movement routines for automatic playback when they are needed. For example, you can teach the camera the movements of the people you want to monitor, by replaying the stored parameters complicated movements are done automatically.

■ Camera Position Memory

The system can be configured with up to 32 camera positions. A particular camera position can be selected and viewed by entering the applicable preset number on the system controller 10-key pad.

■ Motion Detection

The system can be configured so any motion on the monitor screen during surveillance causes output of an alarm signal.

This function can be used to structure a system with a VTR that records images of nighttime intruders.

ACCESSORIES

Operating Instructions (this manual) 1 pc.

The following items are for installation.

Decorative Cover 1 pc.

Dust Protection Sheet 1 pc.

8P Alarm Cable 1 pc.

4P Alarm Cable 1 pc.

Connector for 24 V AC (only for WV-CS574E) 1 pc.

OPTIONAL ACCESSORIES

Dome Cover (approx. 60 % transparency, smoked type) WV-CS2SE

Dome Cover (approx. 50 % transparency, smoked type) WV-CS2SHE

Dome Cover (approx. 70 % transparency, metal type) WV-CS2ME

Ceiling Mount Bracket WV-Q105E/WV-Q106E/WV-Q117E

Wall Mount Bracket WV-Q118E

PRECAUTIONS

■ Do not attempt to disassemble the camera.

To prevent electric shock, do not remove screws or covers. There are no user-serviceable parts inside. Ask qualified service personnel for servicing.

■ Handle the camera with care.

Do not misuse the camera. Avoid striking, shaking, etc. The camera could be damaged by improper handling or storage.

■ Do not expose the camera to rain or moisture, nor try to operate it in wet areas.

This product is designed for indoor use or locations where it is protected from rain and moisture.

Turn the power off immediately and ask qualified service personnel for servicing.

Moisture can damage the camera and also create the danger of electric shock.

■ Do not use strong or abrasive detergents when cleaning the camera body.

Use a dry cloth to clean the camera when it is dirty. When the dirt is hard to remove, use a mild detergent and wipe gently. Care should be taken not to scratch the dome cover when wiping it. Afterwards, wipe off the remaining detergent with a dry cloth.

■ Never aim the camera at the sun.

Whether or not the camera is in use, never aim it at the sun or other extremely bright objects. Otherwise, blooming or smear may be caused.

■ Do not point the camera at a strong light source.

Intense light such as that produced by a spotlight concentrated on one part of the screen can cause blooming (rainbow around the strong light) or smearing (vertical stripes above and below the strong light).

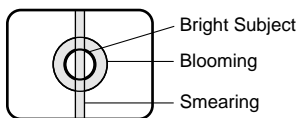

■ Do not install this camera upside down.

This camera is designed for mounting on the ceiling or wall. Using this camera installed upside down, for example, mounted on the floor, may cause malfunction.

■ Do not operate the camera beyond the specified temperature, humidity or power source ratings.

Do not use the camera in an extreme environment where high temperature or high humidity exists. Do not place the camera near heat sources such as radiators, stoves or other units that produce heat.

Use the camera under conditions where temperature is between -10°C - $+50^{\circ}\text{C}$ { 14°F - 122°F }, preferably $+40^{\circ}\text{C}$ { 104°F }, and humidity is below 90 %.

The input power source is 220 V - 240 V AC for WV-CS570 and 24 V AC for WV-CS574E.

■ Do not install the camera near the air outlet of an air conditioner.

The lens may become cloudy due to condensation if the camera is used under the following conditions.

- Rapid temperature fluctuations by switching the air conditioner on and off.
- Rapid temperature fluctuations due to frequent door opening and closing.
- Use in an environment where eyeglasses become foggy.
- Use in a room filled with cigarette smoke or dust. If the lens becomes cloudy due to condensation, remove the dome cover and wipe all moist surfaces with a soft cloth.
- Avoid use of this camera in a food preparation area and other locations where there are large amounts of steam vapor and oil.

■ Consumables

Parts having contacts such as the lens-drive motors, cooling fan motor and slip-rings inside the camera are subject to wear with time. Please ask the nearest service centre about replacement and maintenance of such parts.

■ Do not aim the camera at the same object for a long time.

Burn-in of an image may be caused on the fluorescent screen of CRT.

■ Self-diagnosis Function

If the camera continues operating abnormally for 30 seconds or more due to such an accident as external noise, the camera will automatically reset its power. In the case it happens frequently, check if there would be any environmental cause.

■ About the Camera Cleaning Function

Prolonged use can lead to noise on the monitor and divergence of preset positions.

If such conditions persist even after you perform camera cleaning (page 41), use the special setup menu to execute the "REFRESH" operation (page 50).

If you are using a matrix switcher with a camera cleaning function (WJ-SX550C), configure the matrix switcher Auto Cleaning settings so cleaning is performed once a day.

■ Downloading (saving) or uploading (recovering) camera preset data

When downloading or uploading camera preset data, aim the camera at static objects such as a wall without moving the camera as much as possible.

CONTENTS

IMPORTANT SAFETY INSTRUCTIONS	3
LIMITATION OF LIABILITY	4
DISCLAIMER OF WARRANTY	4
FEATURES	5
■ New DSP for High Sensitivity	5
■ Digital Flip	5
■ Privacy Zone Function	5
■ Patrol Function	5
■ Camera Position Memory	5
■ Motion Detection	5
ACCESSORIES	5
OPTIONAL ACCESSORIES	5
PRECAUTIONS	6
CONSTRUCTION	9
INSTALLATION PRECAUTIONS	10
DIP SWITCH SETTINGS	11
■ Communication Parameters (DIP Switch 2)	11
■ Unit Number (DIP Switch 1)	12
■ RS485 Communication Parameters (DIP Switch 1)	13
CAMERA INSTALLATION	14
■ Preparing the Camera and Decorative Cover for Side Cable Exit	14
■ Installing the Camera	14
UNINSTALLING THE CAMERA	16
■ Uninstalling the Camera	16
CONNECTIONS	17
RS485 SETUP	19
USING THE SETUP MENU	20
■ Setup Menu	20
■ Setup Menu Description	22
SETTING PROCEDURES	26
■ Menu Display	26
■ Preset Menu	26
■ Deleting Preset Positions	31
■ Home Position Setting (HOME POSITION)	31
■ Self Return Setting (SELF RETURN)	31
■ Auto Mode Selection (AUTO MODE)	32
■ Auto Pan Key Setting (AUTO PAN KEY)	33
■ Digital Flip Setting (DIGITAL FLIP)	34
■ Special 1 Menu Setting (SPECIAL 1)	35
■ Camera Setting	42
SPECIFICATIONS	52
SHORTCUTS	54
TROUBLESHOOTING	56

CONSTRUCTION

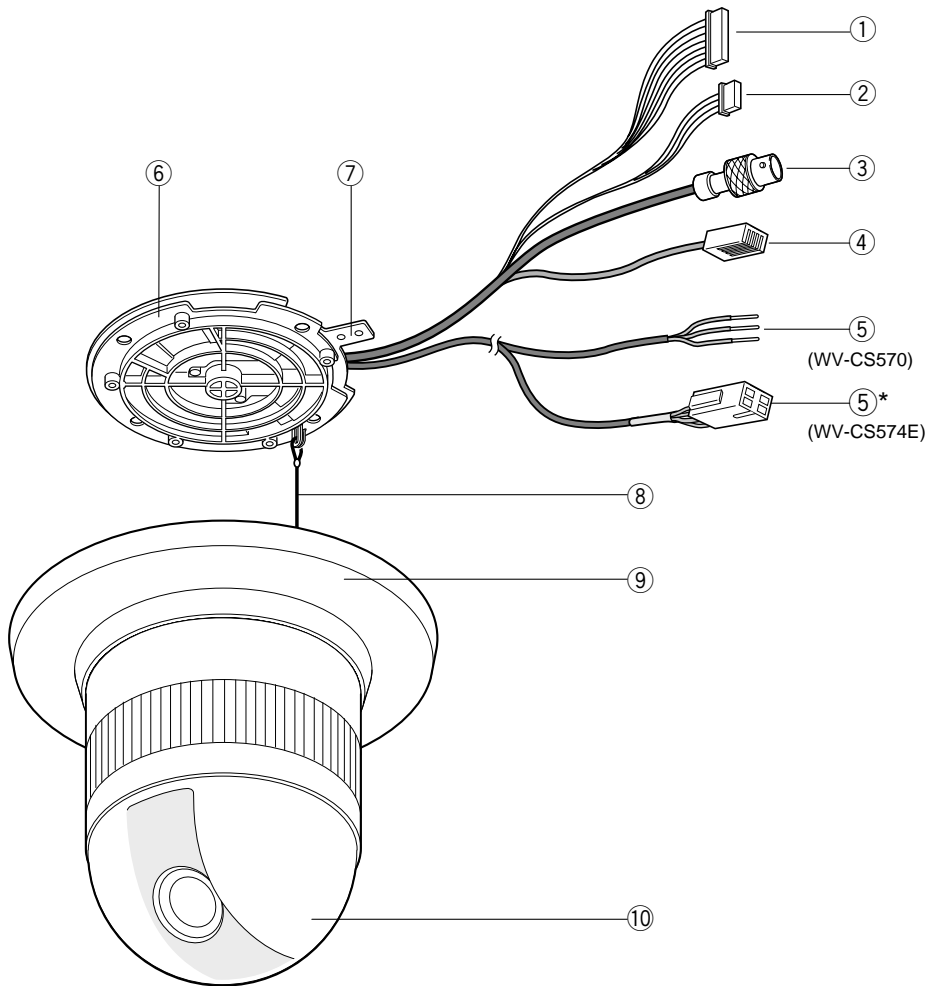

① Alarm Input Connector

② Alarm Output Connector

③ Video Output Connector

④ Data Port

⑤ Power Cable for WV-CS570

⑤* Power Cable for WV-CS574E

⑥ Camera Mounting Base

⑦ Panning Start Point

⑧ Fall Prevention Wire

⑨ Decoration Cover

⑩ Dome Cover

Ensuring Trouble-free Operation

- This camera uses a "slip ring" for transmission of electrical power and signals. A dirty slip ring can cause deterioration of picture quality during panning and generation of noise. In order to ensure trouble-free camera operation, make sure that the cleaning function (page 41) is turned on.
- If cleaning the slip ring does not eliminate poor picture quality and noise, it could mean that the slip ring has reached the end of its service life. Contact a qualified service person or system installer to have it replaced.

INSTALLATION PRECAUTIONS

Warning:

Discuss the installation location for the camera with your retailer, and select a place that is strong enough for the installation. If you install the camera on a ceiling or wall, except for accidents caused by fault in the camera, Panasonic holds absolutely no responsibility for accidents caused by the camera falling due to unsuitable installation. Take sufficient care when installing the camera. If the installation is not strong enough, be sure to sufficiently reinforce the location and check that it is safe.

Warning:

Always request installation work from a qualified service person or system installer. Lack of technical knowledge creates the risk of fire, electric shock, personal injury, and material damage.

■ Camera Installation Location

- Install the camera on a ceiling (concrete, etc.) at a location that is sufficiently strong to support it.
- When installing the camera on a ceiling of insufficient strength (like a drop ceiling), use the optionally available WV-Q105E Direct Attachment Ceiling Mounting Bracket or the WV-Q106E Embedded ceiling Mount Bracket.
- For ceiling mounting, use the optionally available WV-Q117E Ceiling Mount Bracket.
- For wall mounting, use the optionally available WV-Q118E Wall Mount Bracket.

■ This camera is an indoor camera. It is not designed for outdoor use.

■ This camera is designed for use in a hanging configuration only. Using it in an upright or inclined configuration can cause malfunction and shorten the life of the camera.

■ Install the camera in a horizontal configuration, with the dome pointed downwards.

■ Never install or use the camera in the following locations.

- Areas directly exposed to rain and water
- Near a swimming pool or other areas where chemicals are used
- Food preparation areas and other locations where there are large amounts of steam vapor and oil, in flammable atmospheres, other special environments
- Areas where radiation, X-rays, strong electric waves, or magnetism is generated
- At sea, in coastal areas, or in areas where corrosive gas is being generated
- Areas outside of the allowable ambient operating temperature range (-10 °C to +50 °C {14 °F to 122 °F})

- In a motor vehicle, on a boat, or other areas subject to strong vibration (This camera is not designed for use in a vehicle.)
- Near an air conditioner outlet, near a door that opens up to the outdoors, or any other area subjected to temperature extremes (Such conditions can cause clouding and condensation formation on the dome cover.)

■ Wiring the Camera

- If you need to connect a ground, be sure to do it before you connect the main power plug. Also, when removing the ground, be sure to disconnect the main power plug.
- The camera does not have a power switch, so it turns on as soon as the power cord is plugged into a power outlet. During the electrical work, configure the power supply to the camera so it can be turned on and off. A self-cleaning function is activated (PAN/TILT/ZOOM/FOCUS) when the camera is turned on.

■ When wiring the camera, its cables (power, video output, RS485, alarm in, alarm out) can exit out the side or the top of the camera.

- When using the top cable exit configuration, drill a hole in the ceiling to allow passage of the cables. (See step 3 on page 15.)
- When using the side cable exit configuration, prepare the cutout in the die cast case and decorative cover. (See "Preparing the Camera and Decorative Cover for Side Cable Exit" on page 14.)

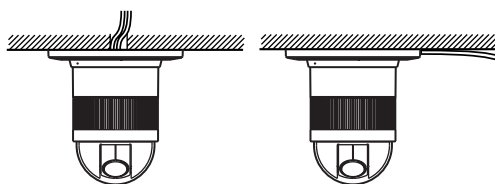

■ Noise interference considerations

When using a power line that is greater than 220 - 240 V AC and wiring that is longer than 1 meter, wiring should be performed using a separate metal conduit. (The metal conduit must be earth grounded.)

■ Screws should be ordered separately.

The camera does not come with screws. Make sure that the materials and structure of the installation location is strong enough to support the total weight of the camera.

Important:

Before setting up the camera for a configuration where the camera's RS485 data port is used for camera control (pan, tilt, etc.) by the system controller, the camera's DIP switches must be configured to specify the unit number and communication parameters. (This page)

If DIP switch setting is not performed, the system controller control will not be possible and camera setup will have to be performed again. Be sure to check the DIP switch settings before setting up the camera.

Heat radiation

The surface of the camera radiates heat. Ventilation holes should be provided when installing the camera in an enclosed ceiling or confined location where heat can build up.

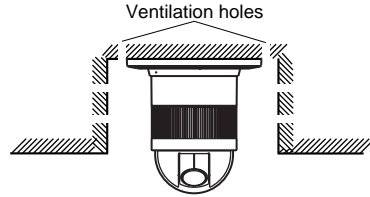

Beware of high humidity.

If the camera is installed when humidity is very high, moisture may collect in the camera and cause the dome to become foggy. If the dome becomes foggy, remove it when the humidity is low and eliminate the moisture inside the camera, and then replace the dome. (page 9)

DIP SWITCH SETTINGS

In a configuration where the camera's RS485 data port is used for camera control (pan, tilt, etc.) by the system controller, the camera's DIP switches must be configured to specify the unit number and communication parameters. The camera mounting base needs to be removed to access the DIP switches. See steps 1 to 3 on page 16 for information about how to remove the camera mounting base.

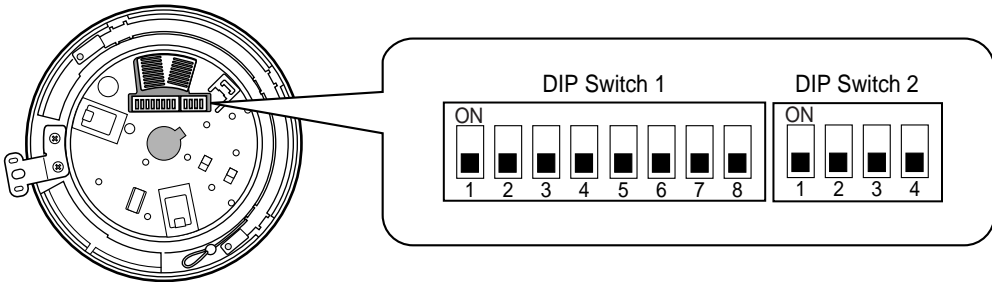

Communication Parameters (DIP Switch 2)

The factory default settings of these DIP switches are all OFF.

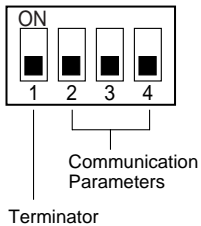

Switch 1: Terminator (Internal Termination Resistance)

Set it to ON in the following situations.
When only one camera is connected.
When only one camera is connected via a daisy chain over a long distance.

Switches 2 through 4: Communication Parameters

This setting toggles between 2-line and 4-line communication. Use these switches to select the communication protocol being used.

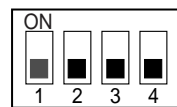

4-line Communication

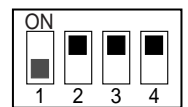



























2-line Communication

■ Unit Number (DIP Switch 1)

The factory default settings of these DIP switches are all OFF. (Coaxial Multiplex System)

DIP Switch 1	Unit Number	DIP Switch 1	Unit Number	DIP Switch 1	Unit Number
	1 ~ 96 *		23		46
	1		24		47
	2		25		48
	3		26		49
	4		27		50
	5		28		51
	6		29		52
	7		30		53
	8		31		54
	9		32		55
	10		33		56
	11		34		57
	12		35		58
	13		36		59
	14		37		60
	15		38		61
	16		39		62
	17		40		63
	18		41		64
	19		42		65
	20		43		66
	21		44		67
	22		45		68





DIP Switch 1	Unit Number	DIP Switch 1	Unit Number	DIP Switch 1	Unit Number
	69		78		87
	70		79		88
	71		80		89
	72		81		90
	73		82		91
	74		83		92
	75		84		93
	76		85		94
	77		86		95

* When using the Unit Number 1 to 96 setting, the unit number setting needs to be configured using the RS485 SET UP menu. For details about configuring this setting, see step 2 and page 19.

* Turning on power when this setting is selected causes the RS485 SET UP menu to appear during the initialization routine.

■ RS485 Communication Parameters (DIP Switch 1)

Configuring DIP Switch 1 as shown below resets communication parameters to their factory default settings. You can then change the settings as desired.

DIP Switch 1	Setting Description
	This setting resets communication parameters to the factory default settings.
	BAUD RATE : 19 200 bit/s, DATA BIT : 8 bit, PARITY CHECK : NONE, STOP BIT : 1 bit
	BAUD RATE : 9 600 bit/s, DATA BIT : 8 bit, PARITY CHECK : NONE, STOP BIT : 1 bit
	BAUD RATE : 4 800 bit/s, DATA BIT : 8 bit, PARITY CHECK : NONE, STOP BIT : 1 bit

Perform the following steps to use this setting.

(1) Turn off the camera and use DIP Switch 1 to configure RS485 communication parameters as shown above.

(2) Turn on the camera.

This applies the setting you configured in step (1).

(3) Turn off the camera, use DIP Switch 1 to set the unit number (pages 12 and 13), and then turn the camera back on again.

CAMERA INSTALLATION

■ Preparing the Camera and Decorative Cover for Side Cable Exit

The camera and decorative cover should be prepared as shown below when mounting the camera on a ceiling or wall with its cables (power, video output, RS485, alarm in, alarm out) exiting from the side.

The camera mounting base needs to be removed in order to prepare the camera. See steps 1 and 2 below for information about how to remove the camera mounting base.

Cutout in Diecast Case

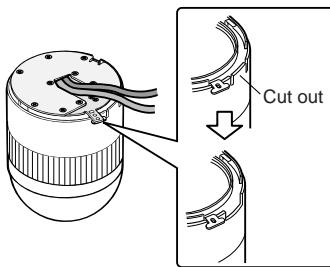

Cutout in Decoration Cover

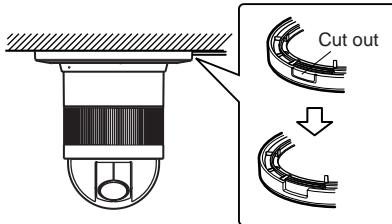

■ Installing the Camera

- Select an installation location that is strong enough to withstand the total weight of the camera. Installing the camera at a location that is too weak can cause it to fall.
 - Remove the protective sheet after the installation work is complete.
 - If you are using an optional bracket to install the camera, install the bracket in accordance with the instructions that come with it.
1. Remove the fixing screw (M3 × 6) that secures the camera to the mounting base. Put the screw in a place where it will not become lost.

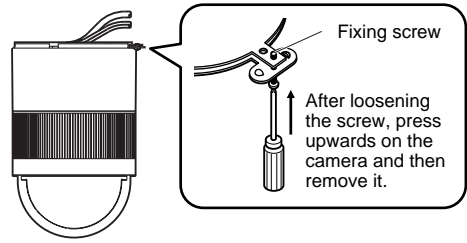

2. Rotate the camera base unit in the direction indicated by the arrow and remove it.

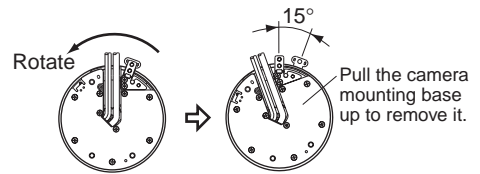

3. Using the camera mounting base as a template, mark the locations of the four mounting holes on the ceiling.

If you are using the top cable exit configuration, mark the location of the cable hole on the ceiling and drill the hole.



4. Affix the camera mounting base onto the ceiling. Use screws (M4) at the locations you marked above to secure the mounting base to the ceiling. If you do not plan to install the camera right away, affix the dust protection sheet that comes with the camera to the mounting base to keep dust off of it.

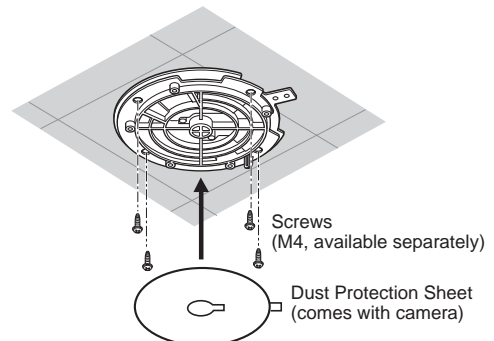

- Hook the fall prevention wire on the camera mounting base.

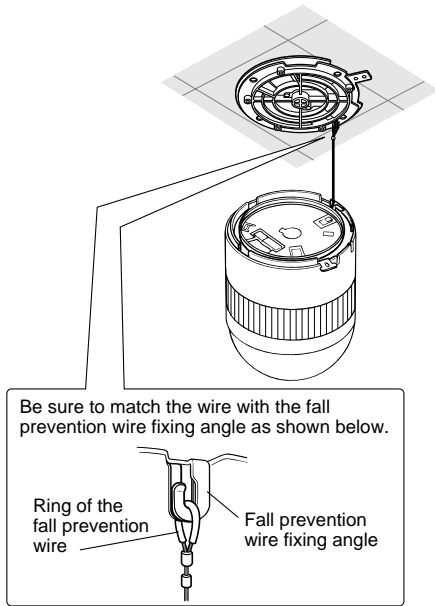

Cautions:

- Use the supplied dust protection sheet if the camera mounting base is liable to be exposed to a dusty atmosphere. Remove the cover from the dust protection sheet, then stick the sheet on the camera mounting base.
- Remove the sheet before mounting the camera on the base.
- While the camera is separated from the base, keep the camera in the supplied polyethylene sack.

- Mount the camera on the camera mounting base and rotate the camera clockwise.

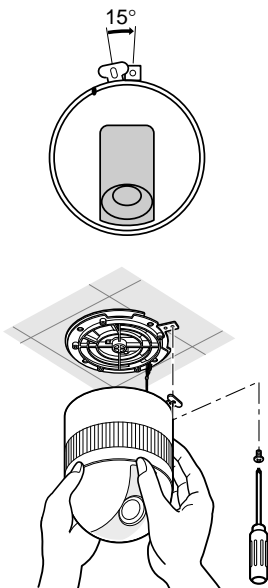

- Tighten the fixing screw M3 (provided).

Notes:

- Tighten the camera fixing screw with a screwdriver.
- Follow the instructions given here to ensure that the camera and camera mounting base are installed safely.
- When removing the camera from the camera mounting base, loosen and press up the camera fixing screw (M3) with a screwdriver.

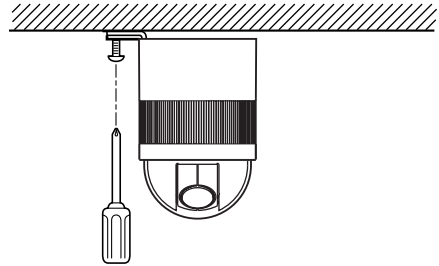

- Fix the decoration cover to the camera mounting base.

a. Sideway Cable Exit

Pass the cables through the cutout made in the diecast case and decoration cover.

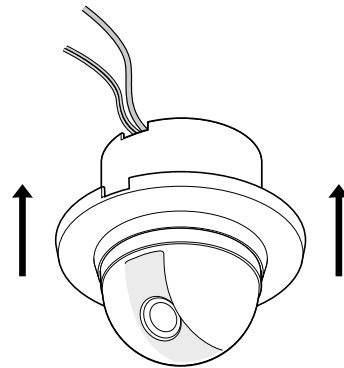

b. Top Cable Exit

Push the decoration cover against the camera mounting base.

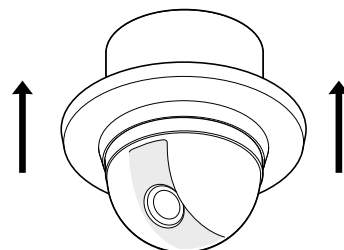

UNINSTALLING THE CAMERA

Caution:

Make sure you perform the steps below carefully and exactly when uninstalling the camera and decorative cover. Failure to do so creates the risk of damage to the camera.

■ Uninstalling the Camera

The camera and its base unit are secured by screws. This configuration provides double anchoring, and you should use the following procedure to uninstall the camera.

1. Remove the fixing screw that secures the camera to the mounting base.
Put the screw in a place where it will not become lost.
2. Remove the camera from the mounting base.
Rotate the camera in the direction indicated by the arrow and remove it.

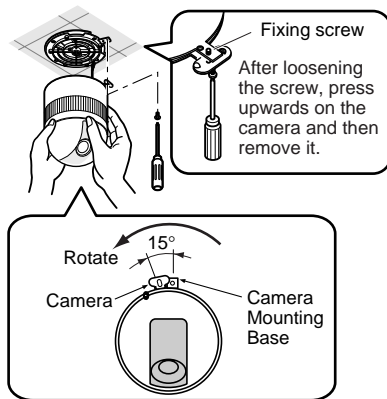

3. Remove the safety wire from the mounting base.

CONNECTIONS

Precautions

- The following connections should be made by qualified service personnel or system installers in accordance with all local codes.
- See the reverse side of the cover page for main lead connection.

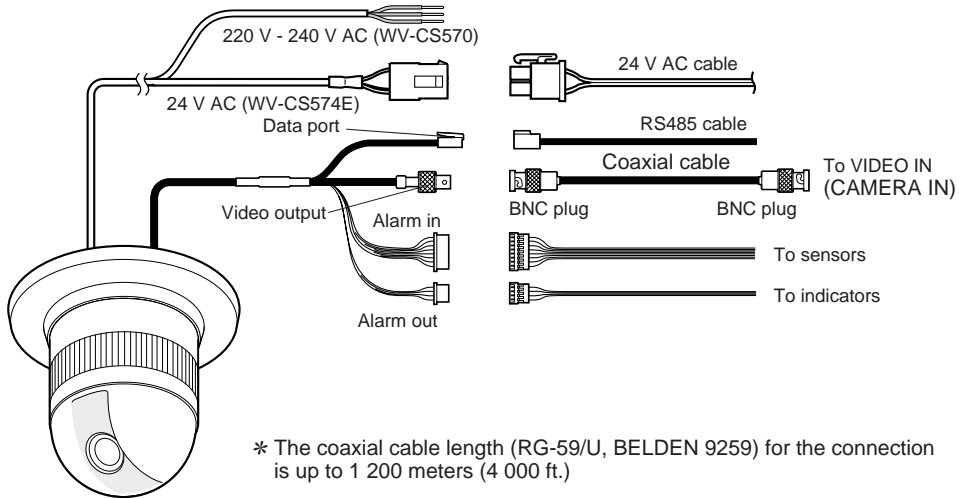

Note:

When powered up, the unit performs a self-check (including one panning, tilting, zooming and focusing operation).

• 24 V AC Power Supply Connection

Recommended wire gauge sizes for 24 V AC line

Copper wire size (AWG)		#24 (0.22mm ²)	#22 (0.33mm ²)	#20 (0.52mm ²)	#18 (0.83mm ²)
Length of cable (approx.)	(m)	20	30	45	75
	(ft)	65	100	160	260

Accessory Connector Information

Pin no.	Power source
1	24 V AC LIVE
2	24 V AC NEUTRAL
3	Ground
4	Not use

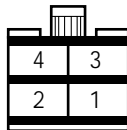

Prepare the individual conductors for clamping. Use MOLEX band tool part number 57027-5000 (for UL-Style Cable UL1015) or 57026-5000 (for UL-Style UL1007) for clamping the contacts.

After clamping the contacts, push them into the proper holes in the accessory connector of this camera until they snap in place.

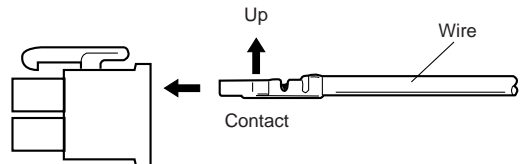

How to Assemble the Cable with the Accessory Connector

Strip back the cable jacket approx. 3 mm (0.1 inch) and separate the individual conductors.

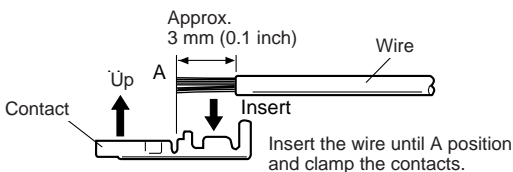

CAUTIONS

- Shrinking the cable-entry seal is a one-time procedure. Do not shrink the cable-entry seal until ascertaining that the unit is functioning.
- CONNECT THIS TO 24 V AC CLASS 2 POWER SUPPLY ONLY.

• RS485 Connection

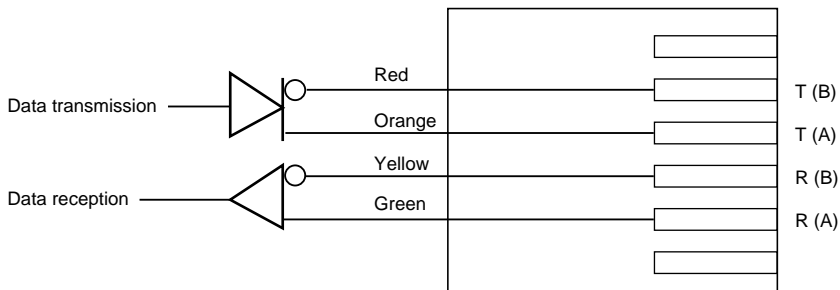

Note:

Use the cable that is described below for RS485 site communication.

- Shielded, twisted pair cable
- Low impedance
- Wire gauge size is thicker than AWG #22 (0.33 mm²).

• ALARM IN Connections

An 8-pin and a 4-pin harness are supplied with the camera as standard accessories. Connect external sensors to this connector. Input specifications are low-active, non-voltage contact (ON when active) or open collector (Low when active). The table below shows wire colours versus pin functions.

Alarm IN (8-pin)

Wire colour	Function
Black	IN 1
Brown	GND
Red	IN 2
Orange	GND
Yellow	IN 3
Light blue or green	GND
Blue	IN 4
Purple	GND

• ALARM OUT Connections

Connect an external device, for example, a buzzer or lamp, to this connector. Output specifications are low-active, open-collector and a drive capacity of 16 V DC 100 mA maximum. The table below shows wire colours versus pin functions.

Alarm OUT (4-pin)

Wire colour	Function
Grey	OUT 1
White	GND
Pink	OUT 2
Yellow green or light blue	GND

Note:

Use a relay if the voltage or current of the connected device exceeds the ratings.

RS485 SETUP

Use the following procedure to configure the RS485 setup when you want to use the system controller to control the camera (pan, tilt, etc.) via the camera's data port.

1. Display the setup menu (page 26), move the cursor to RS485 SETUP "↓", and then press the CAM (SET) button.

This will display the RS485 setup menu.

2. Check the unit number. (page 12)
The UNIT NUMBER item shows the unit number specified by DIP Switch 1. The factory default unit number is 1.

If DIP Switch 1 specifies 1 to 96 as the unit number, move the cursor to UNIT NUMBER and then tilt the joystick left or right to select a unit number (1 to 96).

* RS485 SETUP *	
UNIT NUMBER	1
SUB ADDRESS	----
BAUD RATE	19200
DATA BIT	8
PARITY CHECK	NONE
STOP BIT	1
XON/XOFF	NOT USE
WAIT TIME	OFF
ALARM DATA	AUTO2
DELAY TIME	OFF
RET	

Note:

It is not necessary to configure the RS485 SETUP menu SUB ADDRESS setting.

3. Move the cursor to BAUD RATE, and then tilt the joystick left or right to select a baud rate setting.
Tilting the joystick cycles through the baud rate (transmission speed) display in the sequence shown below. (unit: bits/s) The factory default setting is 19200.

2400 ↔ 4800 ↔ 9600 ↔ 19200

4. Move the cursor to DATA BIT, and then tilt the joystick left or right to select a data bit setting (7 or 8).
The factory default setting is 8.
5. Move the cursor to PARITY CHECK, and then tilt the joystick left or right to select a parity bit setting (NONE, ODD, EVEN).
The factory default setting is NONE.
6. Move the cursor to STOP BIT, and then tilt the joystick left or right to select a stop bit setting (1 or 2).
The factory default setting is 1.
7. Move the cursor to XON/XOFF, and then tilt the joystick left or right to select an XON/XOFF setting.
The factory default setting is NOT USE.

NOT USE: Disables X ON/X OFF data flow control.

USE: Enables X ON/X OFF data flow control.

8. Move the cursor to WAIT TIME, and then tilt the joystick left or right to select a wait time setting.
The wait time is the time that the camera should wait before resending data when no receive acknowledgement (ACK) is returned after data is sent.

Tilting the joystick cycles through the wait time display in the sequence shown below. (unit: ms) The factory default setting is OFF.

OFF ↔ 100MS ↔ 200MS ↔ 400MS ↔ 1000MS

9. Move the cursor to ALARM DATA, and then tilt the joystick left or right to select an alarm data send mode setting.

POLLING: Sends alarm data in response to a request by the system controller.

AUTO1: Sends alarm data each time an alarm signal is input.

AUTO2: Sends alarm data at five-second intervals. This is the factory default setting.

Note:

When using the preset alarm (page 41), select "AUTO1".

10. Move the cursor to DELAY TIME, and then tilt the joystick left or right to select a delay time setting.
The delay time is the time the camera should wait before sending a receive acknowledge (ACK). The delay time display changes in the sequence shown below. (unit: ms) The factory default setting is OFF.

OFF ↔ 100MS

This setting can be configured only when 2-line configuration is selected by DIP Switch 2. (page 11)

USING THE SETUP MENU

■ Setup Menu

Setup menus are shown in the diagram below. You can adapt the camera to your requirements by setting up the respective items in these menus. Menus are incorporated in a hierarchical structure, from the setup menu at the top to manual mask area selection at the bottom. These menus are described on the following pages for reference. Switches, buttons, keys and the joystick are used in the setup operations.

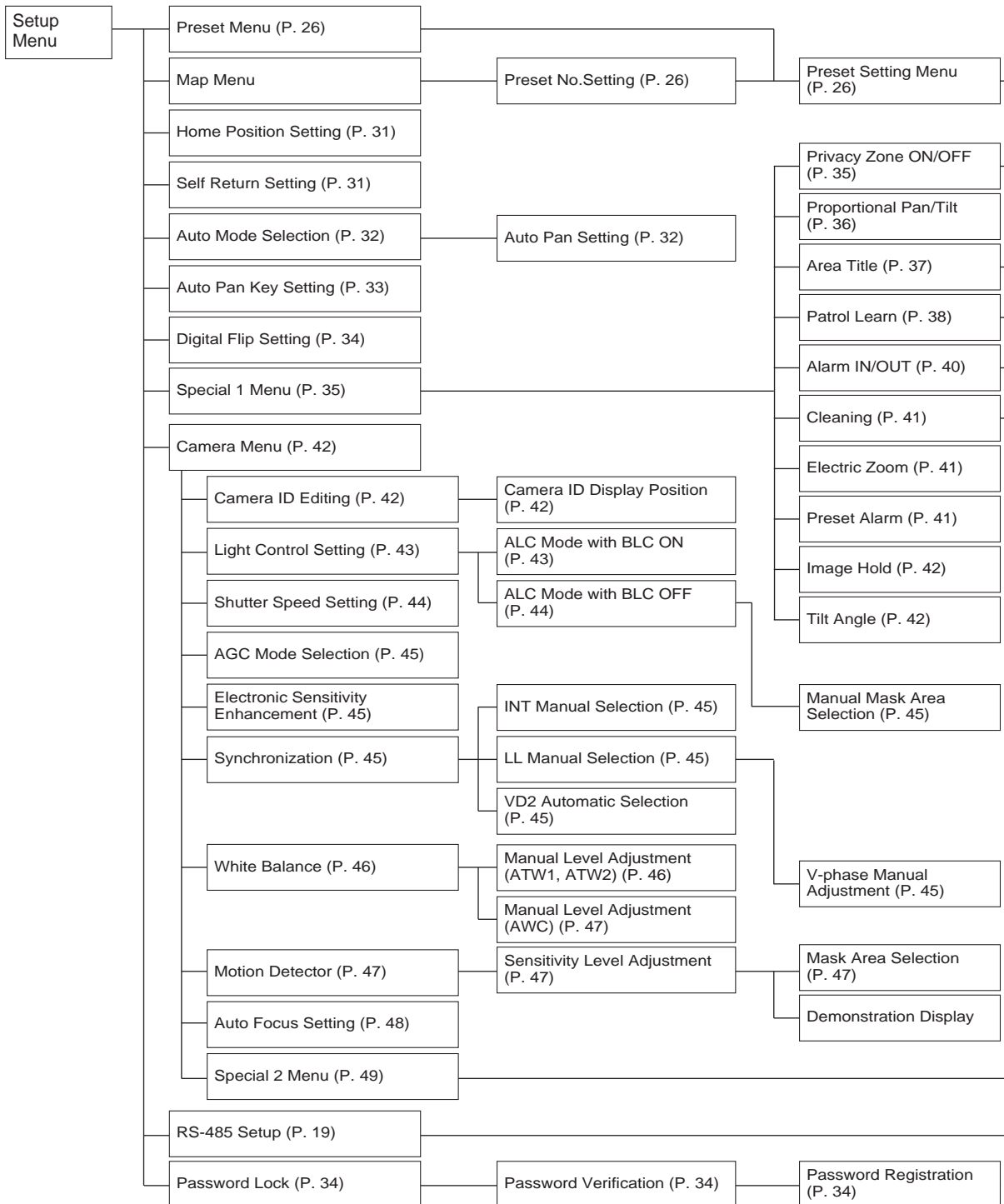

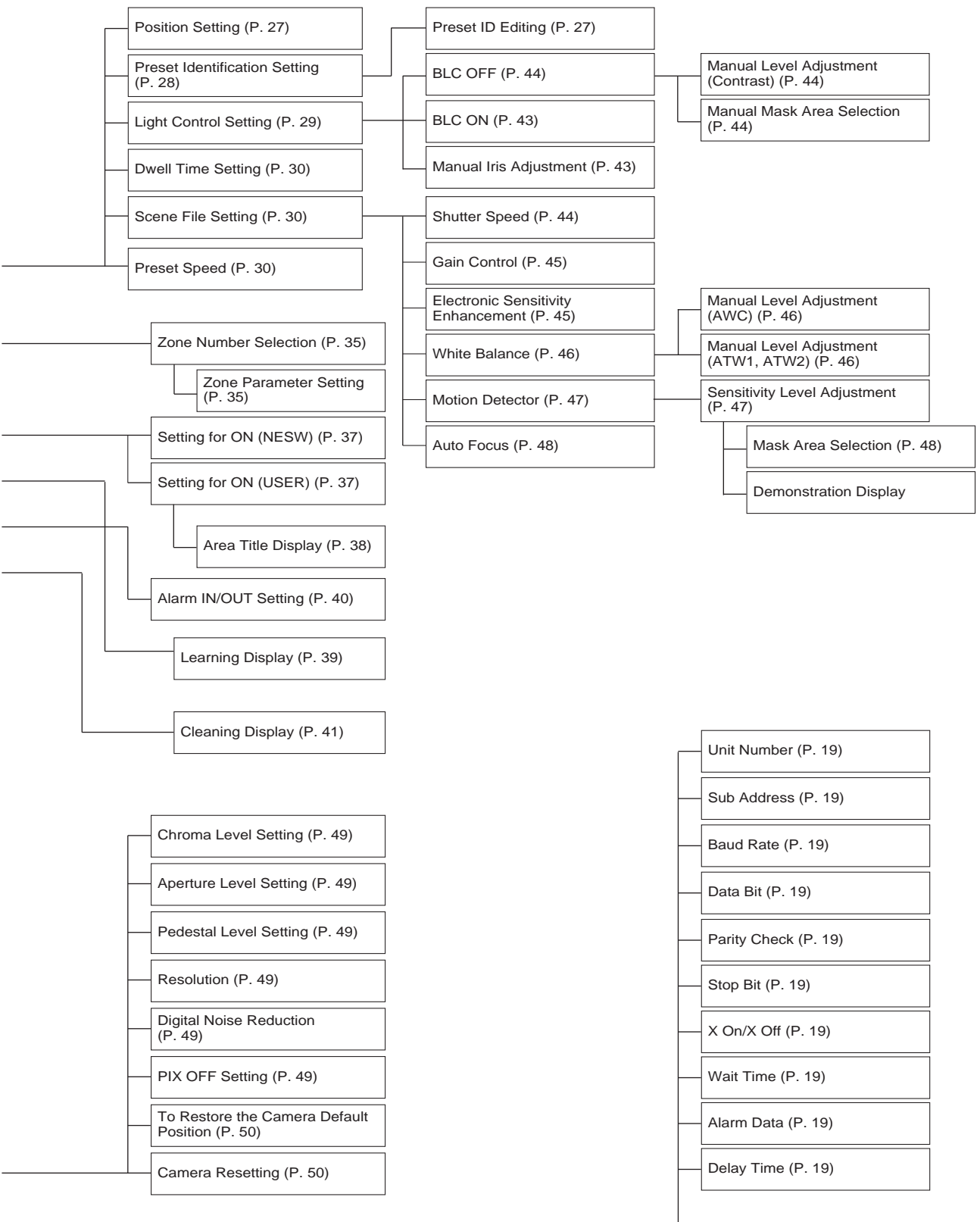

■ Setup Menu Description

● Presetting

(1) Position (POSITION SET)

Aligns the camera position and focal point by panning, tilting, zooming and focusing.
See page 27 for the setting.

(2) Preset Identification (PRESET ID)

Assigns the name for preset IDs (identification of up to 16 alphanumeric characters) and can be switched on or off on the monitor screen.
See page 28 for the setting.

(3) Light Control (ALC/MANUAL)

Selects the ALC or MANUAL mode for adjusting the lens iris.
See page 29 for the setting.

(4) Dwell Time (DWELL TIME)

Displays the picture at each camera position for the selected duration.
You can select a preset duration from the menu.
See page 30 for the setting.

(5) Scene File (SCENE FILE)

Stores up to 10 files.
Each file has a set of detailed parameters for the shutter speed, AGC, electronic sensitivity enhancement, white balance, motion detector and AF mode. The scene files can be recalled later to reproduce the parameter settings under the same conditions as stored in the files.
See page 30 for the setting.

● Home Position (HOME POSITION)

The home position is the camera's basic position. The camera returns to this position automatically after a specific time following a manual operation. This setting functions only when AUTO MODE is OFF.
See page 31 for the setting.

● Self Return (SELF RETURN)

The self return function allows the camera to resume one of the operations described below after specified time.

This function automatically works after a lapse of setting time from manual operation finished.

OFF: Cancels the auto mode (SEQ, SORT, AUTO PAN and PATROL).

AT (the auto mode is set to OFF): Shifts the camera direction to the home position.

AT (the auto mode is set to other than OFF): Activates the auto mode.

HP: Shifts the camera direction to the home position.

AP: Starts the auto pan function.

SQ: Starts the sequence function.

SR: Starts the sort function.

PT: Starts the patrol function.

See page 31 for the setting.

● Auto Mode (AUTO MODE)

The auto mode is used for setting the movement of the camera.

You can select one of four automatic operation modes and one manual operation mode as follows:

OFF: No automatic operation. The camera can be operated only manually.

SEQ: The camera operates in the sequence of preset positions in numerical order.

SORT: The camera operates in the sequence of preset positions counterclockwise from pan starting point.

AUTO PAN: The camera automatically turns within the preset panning range.

PATROL: The camera operates in the patrol-learn function.

See page 32 for the setting.

● Auto Pan Key (AUTO PAN KEY)

This setting assigns the SEQ, SORT, AUTO PAN or PATROL (PLAY) mode to the AUTO button on the controller.

After this setting, the AUTO button performs as assigned.

Note:

The AUTO PAN LED on the controller does not light if a mode other than AUTO PAN is assigned.

● Digital Flip (DIGITAL FLIP)

Tilt range is limited within -5° to 90° if OFF is selected. If ON is selected it widens the range up to 190° with the digital flip that reverses horizontal and vertical scanning when the camera is tilted beyond 90° point (Downright position if the camera is installed on a ceiling). Tilt range narrows from -5° to 90° if PAN LIMIT is set to ON.

Note:

When trying to set preset positions directly from the WV-CU360 System Controller for the first time while the camera is tilted beyond 90° , the INHIBIT indication will be displayed on the monitor screen. This indication will disappear when trying the next time and it will be possible to register the preset position.

● Password Lock (PASSWORD LOCK)

This menu limits setting changes.

● Special 1 Menu

(1) Privacy Zone (PRIVACY ZONE)

This setting is used for masking unwanted zones, hiding them from display on the monitor screen. Up to 8 zones can be registered. Submenus are provided for zone number selection and parameter setting. See page 35 for details.

(2) Proportional Pan-Tilt Speed (PROPO. P/T)

If ON is selected, the pan-tilt speed changes automatically corresponding to the zoom ratio. For example, the pan-tilt speed slows down when the camera zooms in. See page 36 for details.

(3) Area Title (AREA TITLE)

Up to 8 area titles can be assigned to specific scenes on the DIRECTION (NESW) menu or by alphanumeric (USER) assignment. The area title is displayed under the camera ID on the monitor screen when the camera turns to a position that has been assigned an area title. See page 37 for details.

(4) Patrol-learn and Patrol Play (PATROL)

A set of manual operations is stored (LEARN), reproduced (PLAY) or turned inactive (OFF). Patrol operation stops if SEQ, SORT or AUTO PAN is set to AUTO MODE on the SETUP menu. See page 38 for details.

(5) Alarm Input/Output (ALARM IN/OUT)

Alarm input and output are set on a submenu. Preset positions are assigned to ALARM IN 1 to 4. When alarm inputs are supplied via the alarm input connector, the camera turns to the respective positions. Then the camera sends output signals via the alarm output connector or the coaxial cable to the external devices. CNT-CLS (Contact Closure) 1, 2 and COAX ALM OUT are used for alarm output setting. See page 40 for details.

(6) Cleaning (CLEANING)

This is used for refreshing the electro-mechanical contacts built in the camera. Use this function for maintenance when the camera has been directed at a specific spot or panned over a specific range for a long time.

(7) Electronic Zoom (EL-ZOOM)

Up to 10-fold electronic zooming is available besides 22-fold optical zooming.

(8) Preset Alarm (PRESET ALM)

Alarm signals are generated in the following cases if ON is selected.

- When a preset positioning sequence is completed while AUTO MODE is set to SEQ.
- When a preset positioning sequence is completed while AUTO MODE is set to SORT.

- Positioning is completed at the HOME position in the SELF RETURN mode.
- Positioning is completed in the ALARM IN mode.
- When positioning to the starting point is completed while AUTO MODE is set to AUTO PAN.
- When positioning to the starting point is completed while PATROL is set to PLAY.

(9) Image Hold (IMAGE HOLD)

The camera picture remains as a still image on the monitor screen or until the camera reaches the pre-set position. This function is useful for surveillance via a local area network.

(10) Tilt Angle 0°/5°

You can select a titling range. If 5° is selected, the tilting angle is adjustable up to 5° beyond the horizontal position.

● Camera

(1) Camera Identification (CAMERA ID)

You can use the camera identification to assign a name to the camera. The camera ID consists of up to 16 alphanumeric characters. You can select whether to have the camera ID displayed on the monitor screen or not. See page 42 for the setting.

(2) Light Control (ALC/MANUAL)

You can select a mode for adjusting the lens iris. There are two modes as follows:

ALC: The lens iris is automatically adjusted according to the brightness of an object.

You can select one of two modes (BLC ON or BLC OFF) of backlight compensation.

Backlight compensation is available in the ALC mode. It eliminates strong background light which makes the camera picture dark such as a spotlight.

MANUAL: The lens iris is fixed at the value that you have set regardless of the brightness of an object.

• ALC Mode with BLC ON

The important object in a scene is usually placed in the centre of the monitor's screen. In the BLC mode, photometric weight is given more to the centre of the screen (where the important object is located) than to the edge of the picture (where a bright backlight would most likely to be located).

You can use the BLC function if you select ALC. The function eliminates interference by strong background lighting which makes the camera picture dark, such as a spotlight.

See page 43 for the setting.

- **ALC Mode with BLC OFF**

In this mode, the picture is divided into 48 areas. If there is a source of brightness that interferes with the clarity of the picture in these masks, corresponding areas mask the light to keep the clarity of the picture.

Generally, when a light from the background is too strong such as a spotlight, all objects except the main object in the picture are displayed darker because the lens iris is adjusted with respect to strong brightness. This model ignores strong brightness by masking the source of the strong brightness, thereby the main object is displayed clearly.

Note:

The result of field setup of the mask area and level adjustment is fed back (effected) to the lens iris control in the ALC mode.

(3) Shutter Speed (SHUTTER)

You can select a shutter speed from among 1/50 (OFF), AUTO, 1/120, 1/250, 1/500, 1/1 000, 1/2 000, 1/4 000, and 1/10 000 seconds.

See page 44 for the setting.

(4) Gain Control (AGC)

You can set the gain of an image to automatic adjustment [AGC ON (LOW, MID, HIGH)] or fixed (AGC OFF).

See page 45 for the setting.

(5) Electronic Sensitivity Enhancement (SENS UP)

The electronic sensitivity enhancement function varies the shutter speed to increase the sensitivity in low light conditions.

You can select either of the following shutter speeds for SENS UP.

1/25 seconds (x2), 1/12.5 seconds (x4), 1/8.3 seconds (x6), 1/5 seconds (x10), 1/3.1 seconds (x16) or 1/1.6 seconds (x32).

See page 45 for the setting.

There are two modes for SENS UP as follows:

AUTO: If you select x32, the sensitivity is increased automatically up to x32.

FIX: If you select x32, the sensitivity is increased to a fixed x32.

Notes:

- Moving objects will appear blurred when shot in the electronic sensitivity enhancement mode since SENS UP is equivalent to reducing the shutter speed in a still picture camera.
- The horizontal and vertical resolution will be lowered in this mode.
- If the iris opening is too small, the SENS UP/AUTO mode will not function.

(6) Synchronization (SYNC)

You can select the internal sync (INT) mode or the line-lock sync (LL) mode. Additionally, this model accepts the VD2 signal from a specified component. Whenever the VD2 signal is supplied to this camera, the camera automatically switches to the VD2 sync mode.

When you select the line-lock (LL) mode, you can adjust vertical phase.

See page 45 for the setting.

Important Notices:

The priorities of sync modes are assigned as follows:

1. Multiplexed vertical drive (VD2) (highest)
2. Line-lock (LL)
3. Internal sync (INT) (lowest)

Note:

The priorities of the automatic sync modes are the same as the above.

(7) White Balance (WHITE BAL)

You can select either of three modes shown below for white balance adjustment:

- **Auto-Tracing White Balance (ATW1)**

In this mode, the colour temperature is monitored continuously and thereby white balance is set automatically. The colour temperature range for the proper white balance is between approx. 2 700 and 6 000 K. Proper white balance may not be obtained under the following conditions:

1. When the colour temperature is out of the range of 2 700 - 6 000 K.
2. When the scene contains mostly high colour temperature (bluish) objects, such as a blue sky.
3. When the scene is dim.

In these cases, select the AWC mode.

- **Auto-Tracing White Balance (ATW2)**

This mode enables the camera to trace the white balance when it is used in an area lit by sodium lamps.

- **Automatic White Balance Control (AWC)**

In this mode, accurate white balance is obtained within a colour temperature range of approx. 2 300 - 10 000 K.

See page 47 for the setting.

(8) Motion Detector (MOTION DET)

The motion detector detects motion in a scene by monitoring changes in the brightness level. You can select the sensitivity level for the motion on the setup menu.

When the camera detects motion, it sends an alarm signal to the external equipment and stops at its position for the preset dwell time.

See page 47 for the setting.

(9) Auto Focus (AF MODE)

The camera adjusts the focus automatically by sensing the centre of the picture. S, M and L stand for the size of the sensing area: Small, Middle and Large.

See page 48 for details.

MANUAL S, M, L: Auto-focus is activated only when the button that is assigned for the auto-focus function on the controller is pressed.

AUTO S, M, L: Auto-focus is activated automatically while a manual pan, tilt or zoom operation is performed.

Note:

If SENS UP is set to ON except x2 FIX or x2 AUTO, the AUTO (S/M/L) mode is disabled and the MANUAL (S/M/L) mode is automatically selected.

(10) Special 2 Menu (SPECIAL2)

This menu allows you to adjust and set up the following items and functions: chroma level, aperture level and pedestal level.

You can also reset your parameters to the factory default settings.

See page 49 for the setting.

(11) Self-diagnosis Function

If the camera continues operating abnormally for 30 seconds or more due to such accident as external noise, the camera will automatically reset its power. In the case it happens frequently, check if there would be any environmental cause.

● RS485 Communication

Refer to the following pages for the communication parameter settings.

- Full/Half duplex (page 19)
- Transmission speed (4 900 - 19 200 bps) (page 19)
- Parity bit, Stop bit, Flow control (page 19)
- Wait time, Delay time, Alarm output (page 19)
- Camera units (96 units max.) (page 19)
- Termination ON/OFF (page 11)
- Reset parameters (page 13)

SETTING PROCEDURES

The following setting procedures are described on the assumption that this model is used in combination with WJ-SX150 Matrix Switcher and WV-CU650 System Controller.

■ Menu Display

● Setup Menu Display

WV-CU650

1. Select the camera you want to set up (this camera), and the monitor where you want to display the setup menu.
2. Press the MENU button to display LCD MENU CAM 101.
3. Press the ENTER button or CAM (SET) button to display Camera Setup.
4. Press the F1 button.

```

** SET UP MENU **
PRESET 1 ↵
MAP ↵
HOME POSITION OFF
SELF RETURN OFF
AUTO MODE OFF
AUTO PAN KEY AUTO PAN
DIGITAL FLIP ON
SPECIAL1 ↵
CAMERA ↵
RS485 SET UP ↵
PASSWORD LOCK OFF ↵
    
```

WV-CU161C

Press the CAMERA SETUP button for 2 seconds or more to open the SETUP menu.

● Submenu Display

The items marked "↵" can be selected/changed on the submenu.

```

* RS485 SET UP *
UNIT NUMBER 1↵
SUB ADDRESS 1
BAUD RATE 19200
DATA BIT 8
PARITY CHECK NONE
STOP BIT 1
XON/XOFF NOT USE
WAIT TIME OFF
ALARM DATA AUTO2
DELAY TIME OFF
RET
    
```

- Move the cursor to an item with the "↵" mark and press the CAM (SET) button. The submenu appears.

■ Preset Menu

● Preset Menu Display

1. Displaying the preset menu directly
 - (1) Move the cursor to PRESET 1 "↵" and select the position number with the joystick.
 - (2) Press the CAM (SET) button.
The preset setting menu appears on the monitor screen.

```

** SET UP MENU **
PRESET 1 ↵
MAP ↵
HOME POSITION OFF
SELF RETURN OFF
AUTO MODE OFF
AUTO PAN KEY AUTO PAN
DIGITAL FLIP ON
SPECIAL1 ↵
CAMERA ↵
RS485 SET UP ↵
PASSWORD LOCK OFF ↵
    
```

2. Displaying the preset menu from the PRESET NUMBER SET menu
 - (1) Move the cursor to MAP "↵" and press the CAM (SET) button.

```

** SET UP MENU **
PRESET 1 ↵
MAP ↵
HOME POSITION OFF
SELF RETURN OFF
AUTO MODE OFF
AUTO PAN KEY AUTO PAN
DIGITAL FLIP ON
SPECIAL1 ↵
CAMERA ↵
RS485 SET UP ↵
PASSWORD LOCK OFF ↵
    
```

The PRESET NUMBER SET menu appears on the monitor screen.

```

** PRESET NUMBER SET **
1* 2 3 4
5 6 7 8
9 10 11 12
13 14 15 16
17 18 19 20
21 22 23 24
25 26 27 28
29 30 31 32
ID:DOOR
RET
    
```

- (2) Move the cursor to the position number to be set and press the CAM (SET) button.
The preset setting menu appears on the monitor screen.

Notes:

- The * mark indicates that the position number has been preset.
- The character H refers to the home position.
- The second line from the bottom shows the preset ID corresponding to the selected number. "DOOR" next to "ID" in the example shown right is for preset position number 1.
- Preset numbers 1 to 4 are linked to alarm inputs 1 to 4 respectively. If alarm input 1 comes in, the camera turns to preset position 1, and to other positions according to alarm input 2, 3 or 4.

● Position Setting (POSITION SET)

1. Move the cursor to POSITION SET on the preset setting menu and press the CAM (SET) button. The position setting menu appears.

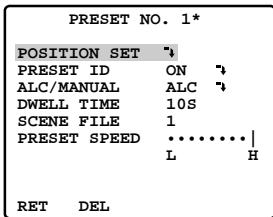

2. To Set Panning/Tilting Positions

- (1) For PAN/TILT, move the cursor to PUSH SET and press the CAM (SET) button. The PAN/TILT setting menu appears.
- (2) Select panning/tilting positions with the joystick, and press the CAM (SET) button. The positions are set and the screen returns to the position setting menu.

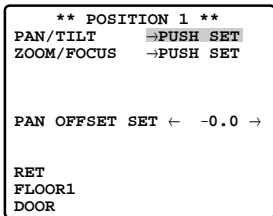
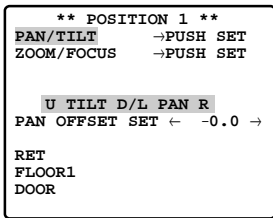

3. Pan Offset

If the camera is replaced with a new one, the pan offset function is used to adjust its positions to be the same as before except patrol setting.

The system controller can download or upload the preset position data.

Caution:

The preset data for other cameras (WV-CS654 for example) is incompatible with WV-CS570/574E. WV-CS570/574E's preset data will be destroyed if you upload the conventional data. If this happened, reset the WV-CS570/574E to the default settings. Download the factory settings into the controller and upload the correct preset data newly to the initialized WV-CS570/574E.

- (1) Display the PRESET NUMBER SET menu.

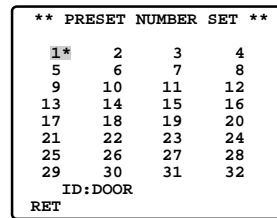

- (2) Select a position number for the picture to be most enlarged among the numbers with the joystick. Then press the CAM (SET) button. The position setting menu appears.
- (3) Move the cursor to PAN OFFSET SET and select the right or left arrow with the joystick.

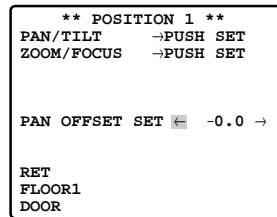

- (4) Press the CAM (SET) button until the desired offset value appears.
- (5) Move the cursor to an item other than PAN OFFSET SET, and press the MON (ESC) button.

Notes:

- Further adjustment of the other positions is unnecessary. This adjustment applies to all other positions.
- Make sure to move the cursor before pressing the button in step 5. Otherwise the settings will be ignored.
- Retry the loading when the camera fails to upload or download the data.

4. To Set the Lens Zoom and Focus Positions

- Move the cursor to PUSH SET for ZOOM/FOCUS and press the CAM (SET) button. The ZOOM/FOCUS setting menu appears.

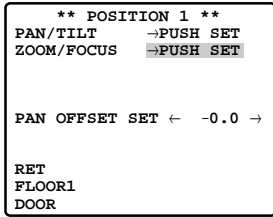

- Select zoom/focus positions with the joystick, and then press the CAM (SET) button.

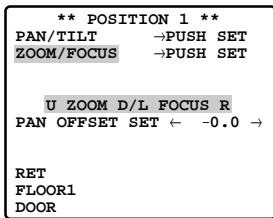

The positions are set and the screen returns to the position setting menu.

Notes:

- When the camera is used at a nearly horizontal angle, the focus may not be adjustable to a high level of accuracy because of the molding distortion of the dome cover.
- If you move the cursor to the position number and move the joystick right or left, the position number can be selected. The selected preset position number can also be set after pressing the CAM (SET) button.
- The preset and camera IDs appear in the lower-left corner of the position setting menu after setting them.

- Move the cursor to RET and press the CAM (SET) button to return to the preset setting menu.

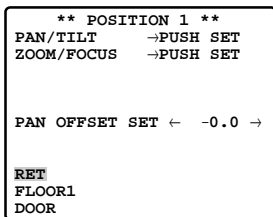

● Preset Identification Setting (PRESET ID)

- Move the cursor to PRESET ID on the preset setting menu and select ON or OFF with the joystick. The factory default setting is OFF.

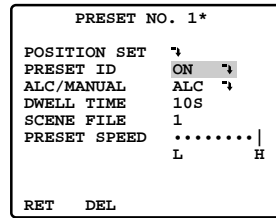

ON: Preset ID appears on the monitor screen.

OFF: Preset ID does not appear.

- Press the CAM (SET) button to display the preset ID setting menu.

To Enter a New Preset ID

- Move the cursor to the desired character using the joystick, and press the CAM (SET) button.
- The selected character appears in the editing area. (The pointer in the editing area moves to the right automatically at this moment.) To enter a blank, select SPACE.
- Repeat the above procedure until all characters are entered.

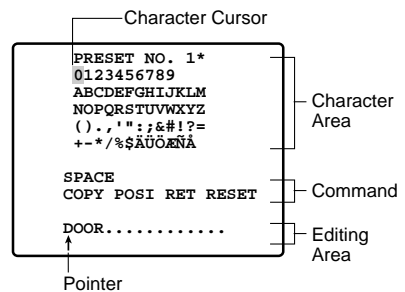

To Copy a Preset ID from Another Position

- Move the cursor to COPY and press the CAM (SET) button. The preset ID in the preceding position is immediately shown. Each consecutive pressing of the CAM (SET) button displays the ID preceding the one currently displayed.

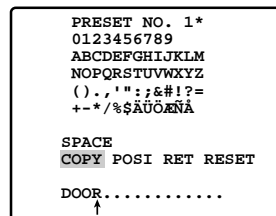

- (2) Display the most prospective ID.
- (3) Follow the step "To Change an Entered Preset ID" if necessary.

To Change an Entered Preset ID

- (1) Move the pointer to the character to be edited in the editing area with the joystick.
- (2) Select a new character with the joystick.
- (3) Press the CAM (SET) button to determine the Preset ID.

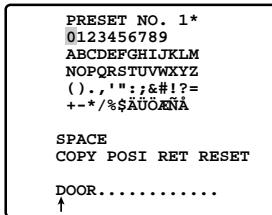

To Delete an Entered Preset ID

Move the cursor to RESET and press the CAM (SET) button.

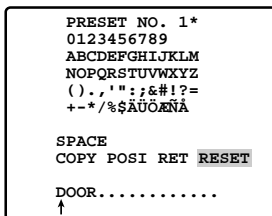

To Set a Display Position for a Preset ID

- (1) Move the cursor to POSI and press the CAM (SET) button. The display position set menu appears.

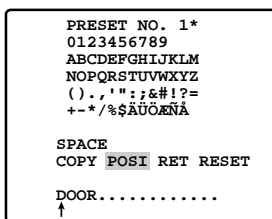

- (2) Move the ID to the desired position with the joystick, and press the MON (ESC) button. The display position is set and the monitor screen returns to the preset ID setting menu.



To Enter the Next ID without Returning to the Preset Setting Menu

- (1) In the preset ID setting menu, move the cursor to the top line and select a desired position number with the joystick.
- (2) Enter, copy, change or delete the ID as described above.

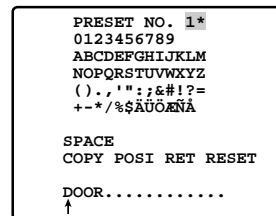

To Return to the Preset Setting Menu

Move the cursor to RET and press the CAM (SET) button.

● Light Control Setting (ALC/MANUAL)

1. Move the cursor to ALC/MANUAL and select ALC or MANUAL with the joystick.

The factory default setting is ALC.

ALC: The lens iris is automatically adjusted to suit the brightness of the object.

MANUAL: The lens iris is fixed at the set value regardless of the brightness of the object.

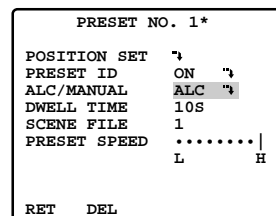

2. In case of ALC ↴
Press the CAM (SET) button. The backlight compensation menu appears on the monitor screen. See page 43 for the setting.
3. In case of MANUAL ↴
Press the CAM (SET) button. The setting menu appears on the monitor screen. Set the lens iris level as desired with the joystick.

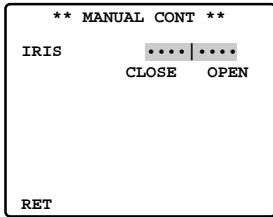

See the pages below for the settings respectively.
 Shutter speed: page 44
 AGC: page 45
 Electronic sensitivity enhancement: page 45
 White balance: page 46
 Motion detector: page 47
 Auto focus: page 48

● Dwell Time (DWELL TIME)

- Move the cursor to DWELL TIME and set a dwell time with the joystick. The factory default setting is 10S. Dwell time changes as follows: S stands for second(s), and MIN stands for minute(s).

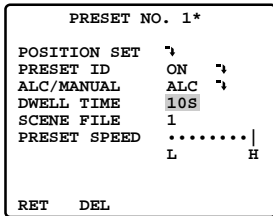

● Preset Speed Setting (PRESET SPEED)

Move the cursor to PRESET SPEED and select a speed with the joystick.

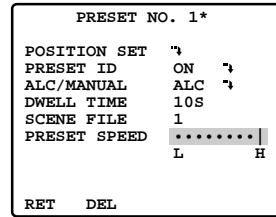

● Scene File Setting (SCENE FILE)

- To set a scene file number
 Move the cursor to SCENE FILE and select a scene file number (1 to 10, or OFF) with the joystick. The factory default setting is 1. No scene file is selected at OFF.

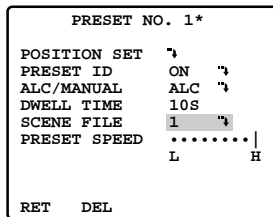

● To Return to the Preset Number Set Menu

Move the cursor to RET and press the CAM (SET) button. The PRESET NUMBER SET menu appears with the * mark on the right of the preset position number.

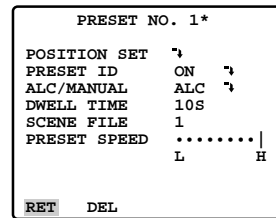

- To set scene file details
 Move the cursor to a scene file number and press the CAM (SET) button. The setting menu appears.

● To Return to the Setup Menu

Move the cursor to RET and press the CAM (SET) button.

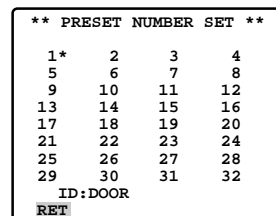
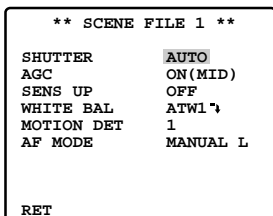

■ Deleting Preset Positions

1. Move the cursor to PRESET 1 and select the position number to be deleted with the joystick.

```

** SET UP MENU **
PRESET 1 ↵
MAP ↵
HOME POSITION OFF
SELF RETURN OFF AT
AUTO MODE OFF
AUTO PAN KEY AUTO PAN
DIGITAL FLIP ON
SPECIAL1 ↵
CAMERA ↵
RS485 SET UP ↵
PASSWORD LOCK OFF ↵
    
```

2. Press the CAM (SET) button to display the preset setting menu.
3. Move the cursor to DEL and press the CAM (SET) button.

```

PRESET NO. 1*
POSITION SET ↵
PRESET ID ON ↵
ALC/MANUAL ALC ↵
DWELL TIME 10S
SCENE FILE 1
PRESET SPEED .....|
                L      H
RET DEL
    
```

This deletes the preset position and the PRESET NUMBER SET menu appears. The * mark on the right of the number disappears.

```

** PRESET NUMBER SET **
 1*  2   3   4
 5   6   7   8
 9  10  11  12
13  14  15  16
17  18  19  20
21  22  23  24
25  26  27  28
29  30  31  32
ID:DOOR
RET
    
```

Note:

Your selected preset number is cancelled only in the SEQ and SORT mode. The previously set parameters (for PAN, TILT positions, etc.) are not changed. If you want to change these parameters, you must set them again.

■ Home Position Setting (HOME POSITION)

1. To set a position number for the home position
Move the cursor to HOME POSITION and select a desired position number with the joystick.
2. Select OFF if you are not using the home position function.

```

** SET UP MENU **
PRESET 1 ↵
MAP ↵
HOME POSITION 15
SELF RETURN OFF
AUTO MODE OFF
AUTO PAN KEY AUTO PAN
DIGITAL FLIP ON
SPECIAL1 ↵
CAMERA ↵
RS485 SET UP ↵
PASSWORD LOCK OFF ↵
    
```

■ Self Return Setting (SELF RETURN)

You can set a return time and one of operation modes with this menu.

1. Move the cursor to SELF RETURN, select a return time from among the following with the joystick and press the CAM (SET) button to confirm your selection.

```

** SET UP MENU **
PRESET 1 ↵
MAP ↵
HOME POSITION 1
SELF RETURN OFF
AUTO MODE OFF
AUTO PAN KEY AUTO PAN
DIGITAL FLIP ON
SPECIAL1 ↵
CAMERA ↵
RS485 SET UP ↵
PASSWORD LOCK OFF ↵
    
```

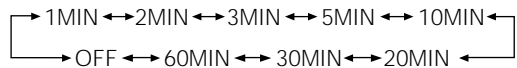

MIN stands for minute(s).

2. Select an operation from among the following with the joystick and press the CAM (SET) button to confirm your selection.

```

** SET UP MENU **
PRESET 1 ↵
MAP ↵
HOME POSITION 1
SELF RETURN 10MIN AT
AUTO MODE OFF
AUTO PAN KEY AUTO PAN
DIGITAL FLIP ON
SPECIAL1 ↵
CAMERA ↵
RS485 SET UP ↵
PASSWORD LOCK OFF ↵
    
```

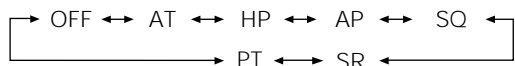

■ Auto Mode Selection (AUTO MODE)

1. To set auto mode

Move the cursor to AUTO MODE and select a mode with the joystick. Modes change as follows:

```

** SET UP MENU **
PRESET 1 ↵
MAP ↵
HOME POSITION OFF
SELF RETURN OFF
AUTO MODE  AUTO PAN ↵
AUTO PAN KEY  AUTO PAN
DIGITAL FLIP ON
SPECIAL1 ↵
CAMERA ↵
RS485 SET UP ↵
PASSWORD LOCK OFF ↵
    
```

2. When AUTO PAN is selected, set details as follows:

```

OFF ↔ SEQ ↔ SORT ↔ AUTO PAN ↔ PATROL ←
    
```

Move the cursor to AUTO PAN **↵** and press the CAM (SET) button to display the AUTO PAN setting menu.

3. To set a panning starting point and panning endpoint

Follow the steps below.

(1) Move the cursor to POSITION and press the CAM (SET) button. The cursor moves to START.

```

** AUTO PAN **
POSITION  START
SPEED    END
         .....|.....
         L      H
ENDLESS  OFF
DWELL TIME 1S
PAN LIMIT OFF
ZOOM LIMIT OFF
RET
    
```

```

** AUTO PAN **
POSITION  START
SPEED    END
         .....|.....
         L      H
ENDLESS  OFF
DWELL TIME 1S
PAN LIMIT OFF
ZOOM LIMIT OFF
RET
    
```

(2) Move the joystick to select a panning starting point and press the CAM (SET) button.

This determines the starting point and the cursor moves to END.

```

** AUTO PAN **
POSITION  START
SPEED    END
         .....|.....
         L      H
ENDLESS  OFF
DWELL TIME 1S
PAN LIMIT OFF
ZOOM LIMIT OFF
RET
    
```

(3) Move the joystick to select a panning endpoint and press the CAM (SET) button.

This determines the endpoint and the cursor moves to POSITION.

4. To set a panning speed

Move the cursor to SPEED, and set a panning speed with the joystick.

```

** AUTO PAN **
POSITION  START
SPEED    END
         .....|.....
         L      H
ENDLESS  OFF
DWELL TIME 1S
PAN LIMIT OFF
ZOOM LIMIT OFF
RET
    
```

The panning speed increases when the joystick is moved to the right, and decreases when it is moved to the left.

Caution:

If the panning range is changed after the camera has not panned for a long time or has been panning in the same panning range, the picture may not be clear or noise may appear. In such cases, pan the camera fully several times.

If this does not eliminate the problem, refer servicing to qualified service personnel.

5. To set ENDLESS to ON/OFF

Move the cursor to ENDLESS, and select ON or OFF with the joystick.

```

** AUTO PAN **
POSITION  START
SPEED    END
         .....|.....
         L      H
ENDLESS  ON
DWELL TIME 1S
PAN LIMIT OFF
ZOOM LIMIT OFF
RET
    
```

ON: The camera pans from the starting point to the endpoint, and keeps rotating in the same direction to return to the starting point. Set PAN LIMIT to OFF before ENDLESS is set to ON.

OFF: The camera pans from the starting point to the endpoint, and rotates backward to the starting point. This movement is repeated over and over.

- To set a dwell time
Move the cursor to DWELL TIME and select a dwell time with the joystick.

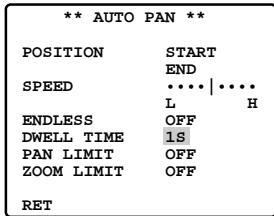

Dwell time changes as follows: (unit: s)

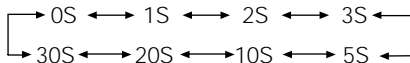

- To set pan limit ON/OFF
Move the cursor to PAN LIMIT and select ON or OFF with the joystick.
The factory default setting is OFF.

ON: Manual pan is limited from the starting point to the endpoint specified by position setting. Set ENDLESS to OFF before PAN LIMIT is set to ON.

OFF: Manual pan is not limited.

Note:

When ON is selected for PAN LIMIT, manual pan moves the camera away from the other side (PAN LIMIT) of the start-end range.

- To set zoom limit ON/OFF
Move the cursor to ZOOM LIMIT and select ON or OFF with the joystick.

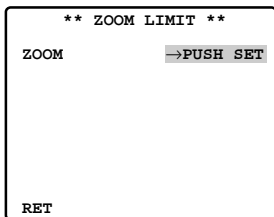

ON: Limits the manual zoom operation by following the procedure below.

- Move the cursor to ZOOM LIMIT, select ON and press the CAM (SET) button.
The ZOOM LIMIT setting menu appears.

- Move the cursor to ZOOM, press the CAM (SET) button, move the joystick to settle the ZOOM position and return to the AUTO PAN menu. The manual zoom operation is not available in the TELE direction beyond the settled zoom position.

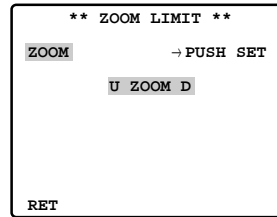

OFF: Does not limit the manual zoom operation.

Notes:

- When the panning, tilting, zooming or focusing in the SEQ, SORT or PATROL mode is controlled manually, the auto mode function should be cancelled.
To activate the auto mode, select the desired auto mode again or set a time for SELF RETURN in the SET UP menu.
- When 0S is selected, the camera stops without dwelling and starts.
- Auto refreshing may be activated during the patrol play or the auto mode to calibrate the lens position.

■ Auto Pan Key Setting (AUTO PAN KEY)

This is used for assigning one of the following auto functions to the AUTO button on the controller. Pressing the AUTO button activates the assigned function after this setting.

- Move the cursor to AUTO PAN KEY and select an auto function with the joystick.
The factory default setting is AUTO PAN.

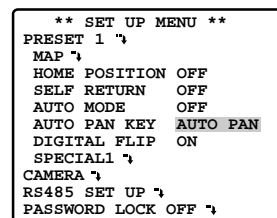

The mode changes as follows:



AUTO PAN: Assigns the auto panning function to the button.

SEQ: Assigns the SEQUENCE function to the button.

SORT: Assigns the SORT function to the button.

PATROL: Assigns the PATROL PLAY function to the button.

Note:

AUTO PAN LED on the controller does not light if something other than AUTO PAN is assigned. AUTO PAN does not stop with the AUTO PAN button.

If PASSWORD LOCK is set to ON, you cannot operate AUTO PAN, SEQ, SORT, and PATROL even by pressing the AUTO button.

■ Digital Flip Setting (DIGITAL FLIP)

Move the cursor to DIGITAL FLIP and select ON or OFF with the joystick.

```
** SET UP MENU **
PRESET 1 ↵
MAP ↵
HOME POSITION OFF
SELF RETURN OFF
AUTO MODE OFF
AUTO PAN KEY AUTO PAN
DIGITAL FLIP ON
SPECIAL1 ↵
CAMERA ↵
RS485 SET UP ↵
PASSWORD LOCK OFF ↵
```

OFF: The tilt range is limited from 0° to 90°.

ON: The digital flip function allows the tilt angle to widen up to 180°. The image on the monitor screen is flipped horizontally and vertically at the tilt angle of approx. 135° (If the camera is installed on a ceiling).

Note:

The tilt range narrows from 0° to 90° if PAN LIMIT is set to ON.

Notes:

- Digital flip functions while moving the joystick downwards. In case of moving the joystick to other directions, it does not function.
- When OFF is selected for DIGITAL FLIP, the following operations are required to move the camera 180° vertically.
 - 1) Move the joystick downwards to aim the camera down.
 - 2) Move the joystick to the right or left to rotate the camera 180° horizontally.
 - 3) Move the joystick upwards.
- To set the preset position directly from WV-CU360 System Controller, it is temporarily required to set both the electronic zoom function and digital flip function to OFF.
Tilt range setting is disabled between 90° and 185°.

● Password Lock (PASSWORD LOCK)

Caution:

For security, do not operate your VTR for recording while the password menus are displayed on the monitor.

A 3-digit number is used for a password to limit access to all settings.

1. Move the cursor to PASSWORD LOCK, then select ON or OFF with the joystick.

```
** SET UP MENU **
PRESET 1 ↵
MAP ↵
HOME POSITION OFF
SELF RETURN OFF
AUTO MODE OFF
AUTO PAN KEY AUTO PAN
DIGITAL FLIP ON
SPECIAL1 ↵
CAMERA ↵
RS485 SET UP ↵
PASSWORD LOCK ON ↵
```

```
** PASSWORD? **
0 1 2 3 4 5 6 7 8 9
      ↑
OK RESET
NEW PASSWORD ↵
RET
```

Note:

ON or OFF can be selected only after going through the password verification.

OFF: You can change all settings.

ON: You cannot change settings at all nor operate AUTO PAN, SEQ, SORT, and PATROL.

2. Press the CAM (SET) button.

Password Verification

3. The password verification menu appears.
 - 3-1 Select a numeral for the first digit with the joystick, and press the CAM (SET) button. Though the entered password is not displayed, the up-arrow moves one character to the right.
 - 3-2 Repeat the above step for the 2nd and 3rd digits.
Default: 123
 - 3-3 The cursor moves to OK after all the three digits have been entered. Unless you want to change the password, press the CAM (SET) button. If the correct password is entered, the screen returns to SET UP MENU. ON and OFF settings are the same as made on the SET UP MENU menu is as set in step 1. If a wrong password is entered, the screen returns to the verification menu. Repeat steps 3-1 to 3-3 to verify the password.

- 3-4 To cancel an incomplete password, move the cursor to RESET, and press the CAM (SET) button. The screen returns to the verification menu.
- 3-5 To return to the SET UP MENU menu without verifying the password, move the cursor to RET, and press the CAM (SET) button.

New Password

- 4. To change the password in step 3-3 above, move the cursor from OK to NEW PASSWORD, then press the CAM (SET) button. NEW PASSWORD menu appears.

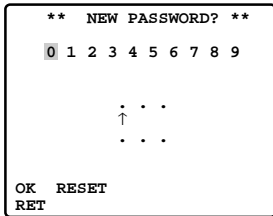

Note:

The NEW PASSWORD menu is accessible only after the verification has been completed.

The up-arrow mark appears indicating the first digit on the first line.

- 4-1 Enter a new three-digit password in the same way as in steps 3-1 to 3-2.
- 4-2 The cursor moves to OK after all the three digits have been entered. Press the CAM (SET) button to move the cursor to the first digit on the second line.
- 4-3 Enter the same password as the one you have entered on the first line.
- 4-4 The cursor moves to OK. Press the CAM (SET) button. If the new password is successfully entered, the screen returns to SET UP MENU.
- 4-5 Retry steps 4-1 to 4-4. If the first entry for the password is different from the second one, the screen returns to the NEW PASSWORD? menu.
- 4-6 To return to the SET UP MENU menu without changing the password, move the cursor to RET, and press the CAM (SET) button.

Special 1 Menu Setting (SPECIAL 1)

Privacy Zone (PRIVACY ZONE)

Up to 8 unwanted zones can be masked on the monitor screen.

- 1. Move the cursor to PRIVACY ZONE and select ON or OFF with the joystick. Press the CAM (SET) button to display the ZONE NUMBER setting menu.

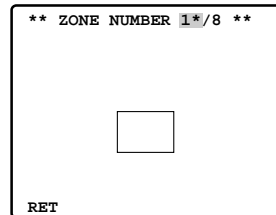
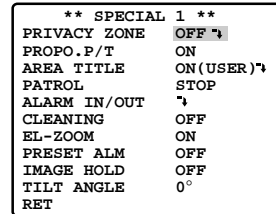

ON: Preset privacy zones are veiled on the monitor screen.

OFF: The veiling function does not work.

- 2. Select a zone number with the joystick, and press the CAM (SET) button.
 - A zone number followed by * (asterisk) indicates that the zone has already been registered.

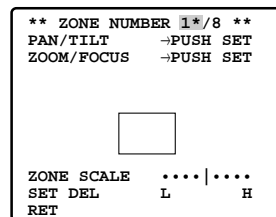

- When a zone number having no * is selected, the picture is zoomed out (WIDE).
- When a registered zone number is selected, the camera moves to the preset position. Note that if you move PAN/TILT, ZOOM/FOCUS or ZONE SCALE in that position, the registered zone number having (*) is cancelled.
- The zone frame appears in the centre of the screen if 3 or fewer mask areas exist in that picture and if the zone number is not registered yet.
- Up to 4 zones can be registered on the fully displayed screen (WIDE).

- When 5 privacy zones or more are framed on the displayed screen in the same time, the whole screen will be masked. In this case, diminish the number of the zones and set the privacy zones larger.
- The privacy zone may appear on the monitor screen depending on the direction of the camera.
- The privacy zone function will not work at start-up immediately after turning the power on.

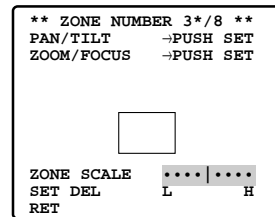

3. To register a new zone

3-1 For PAN/TILT, move the cursor to PUSH SET and press the CAM (SET) button.

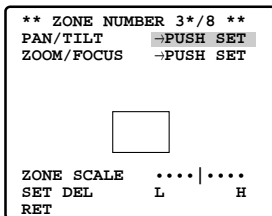

3-2 Adjust the pan and tilt position so that the desired position comes into the zone frame with the joystick.

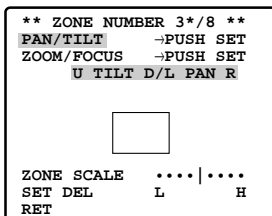

3-3 For ZOOM/FOCUS, move the cursor to PUSH SET, and press the CAM (SET) button.

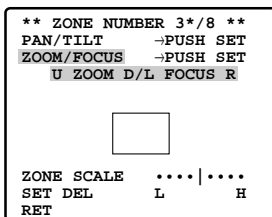

3-4 Adjust zoom and focus, and press the CAM (SET) button.

Zoom can be adjusted within the range of 1 to 10 magnifications.

3-5 Move the cursor to ZONE SCALE, and move the joystick to the right or left to adjust the zone frame. Press the CAM (SET) button after the adjustment.

Moving the joystick in the L direction decreases the zone frame, and moving it in the H direction increases it. However, the aspect ratio is fixed at 3 to 4.

The privacy zone setting has been completed. The menu returns to the ZONE NUMBER setting menu.

3-6

- To complete new settings and repeat other settings, move the cursor to SET and press the CAM (SET) button. The ZONE NUMBER setting menu reappears.
- To cancel new settings and return to the SPECIAL 1 menu, move the cursor to DEL and press the CAM (SET) button. New settings are not registered.
- To complete new settings and return to the SPECIAL 1 menu, move the cursor to RET and press the CAM (SET) button.

● Proportional Pan/Tilt (PROPO. P/T)

Move the cursor to PROPO. P/T and select either ON or OFF with the joystick.

Factory default setting: ON

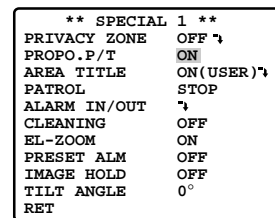

ON: Pan/tilt speed is in inverse proportion to the zoom ratio as follows:

Zoom ratio	Speed level
x1	7 (fastest)
x2	5
x4	3
x8	1
x15 or more	0 (slowest)

* The speed level values are approximate.

OFF: The speed is constant at the fastest level regardless of the zoom ratio.

● Area Title (AREA TITLE)

Up to 8 area titles can be added in specific positions.

1. Select ON (NESW), ON (USER) or OFF with the joystick.

```

** SPECIAL 1 **
PRIVACY ZONE OFF ↵
PROPO.P/T ON
AREA TITLE ON(USER)↵
PATROL STOP
ALARM IN/OUT ↵
CLEANING OFF
EL-ZOOM ON
PRESET ALM OFF
IMAGE HOLD OFF
TILT ANGLE 0°
RET
  
```

ON (NESW): An area title is displayed for indicating the camera direction: North (N), North-East (NE), East (E), South-East (SE), South (S), South-West (SW), West (W) and North-West (NW).

```

** DIRECTION(NESW) **
PAN/TILT →PUSH SET
ZOOM/FOCUS →PUSH SET
POSI ↵
+
N
RET
  
```

ON (USER): A user customized area title appears in a maximum of 16 characters.

OFF: Area title does not appear.

Factory default setting: OFF

2. Press the CAM (SET) button. A submenu appears except when OFF is selected.

Settings for ON (NESW)

1. Move the cursor to PUSH SET for PAN/TILT, and press the CAM (SET) button. PAN/TILT is highlighted and "U TILT D/L PAN R" appears.

```

** DIRECTION(NESW) **
PAN/TILT →PUSH SET
ZOOM/FOCUS →PUSH SET
POSI ↵
U TILT D/L PAN R
+
N
RET
  
```

2. Turn the camera north with the joystick, and press the CAM (SET) button. The origin of the direction (North) is set.

Note:

Area titles are highlighted until the origin is set.

3. Move the cursor to PUSH SET for ZOOM/FOCUS, and press the CAM (SET) button. ZOOM/FOCUS is highlighted and "U ZOOM D/L FOCUS R" appears.

```

** DIRECTION(NESW) **
PAN/TILT →PUSH SET
ZOOM/FOCUS →PUSH SET
POSI ↵
U ZOOM D/L FOCUS R
+
N
RET
  
```

4. Adjust the zoom or focus with the joystick.

5. Move the cursor to POSI ↵, and press the CAM (SET) button. The area title position appears on the monitor screen. If needed, change the display position with the joystick, and press the MON (ESC) button.

An area title always appears under the camera ID. If the camera ID and an area title are set to be shown in separate positions, the area title appears above the camera ID.

```

FLOOR 1
N
  
```

6. Move the cursor to RET, and press the CAM (SET) button. The SPECIAL 1 menu appears again.

Setting for ON (USER)

If ON (USER) is selected on the SPECIAL 1 menu, the AREA TITLE (USER) menu appears. The screen has a number column and title column above RET and RESET.

```

** SPECIAL 1 **
PRIVACY ZONE OFF ↵
PROPO.P/T ON
AREA TITLE ON(USER)↵
PATROL STOP
ALARM IN/OUT ↵
CLEANING OFF
EL-ZOOM ON
PRESET ALM OFF
IMAGE HOLD OFF
TILT ANGLE 0°
RET
  
```

Note:

An area number followed by an asterisk * has already been preset.

```

** AREA TITLE(USER) **
1 * NORTH ↵
2  "  "  ↵
3  "  EAST ↵
4  "  SOUTH-EAST ↵
5  "  SOUTH ↵
6  "  SOUTH-WEST ↵
7  "  "  ↵
8  "  NORTH-WEST ↵

RET  RESET

```

1. To select a camera direction, move the cursor to the desired number, and press the CAM (SET) button. The direction menu of the selected number appears.
2. Adjust PAN/TILT, ZOOM/FOCUS and display the position in the same way as AREA TITLE, DIRECTION (NESW). See page 37.

```

** DIRECTION(USER) 1 **
PAN/TILT    →PUSH SET
ZOOM/FOCUS  →PUSH SET

+
NORTH

RET  DEL

```

3. To add a user-customized title, move the cursor to the title of the desired number, and press the CAM (SET) button. The AREA TITLE menu of the selected number appears.

Area Title Editing

1. Move the cursor to the desired character in the character field with the joystick, and press the CAM (SET) button.
2. The selected character appears in the editing field and the blinking cursor moves one position to the right.

```

AREA TITLE 1*
0123456789
ABCDEFGHIJKLM
NOPQRSTUVWXYZ
( ) . , ' " : ; & # ! ? =
+ - * / % $ Å Ü Ö Æ Ñ Å

SPACE
— POSI RET RESET

↑ .....

```

3. Repeat steps 1 and 2 until one area title is completed.
4. Move the cursor to POSI "↓", and press the CAM (SET) button. The area title appears on the monitor screen. If needed, change the display position with the joystick, and press the MON (ESC) button.

To Quit Editing

- To return to the AREA TITLE menu, move the cursor to RET, and press the CAM (SET) button.
- To cancel one area title, move the cursor to RESET in the AREA TITLE menu, and press the CAM (SET) button.
- To return to the SPECIAL 1 menu, move the cursor to RET, and press the CAM (SET) button.
- To erase all the area titles, move the cursor to RESET in the AREA TITLE (USER) selection menu, and press the CAM (SET) button.

```

FLOOR 1
NORTH

```

Notes:

- An area title appears under the camera ID if both are set in the same position. If the setting is different, they appear in the area title position.
- In case of sharing a common subject in a scene of other camera number, the nearest area title appears while the camera direction deviates within 45° from the set position. If two or more area numbers are set in the same position, the title of the highest number appears.

● Patrol-learn and Patrol Play (PATROL)

A routine of manual operations can be stored for 1 minute at the maximum and reproduced repetitively.

PATROL

```

** SPECIAL 1 **
PRIVACY ZONE OFF ↵
PROPO.P/T ON
AREA TITLE ON(USER)↵
PATROL PLAY
ALARM IN/OUT ↵
CLEANING OFF
EL-ZOOM ON
PRESET ALM OFF
IMAGE HOLD OFF
TILT ANGLE 0°
RET

```

1. Set the following parameters for the patrol-learn starting position. These parameters are stored when the patrol-learn mode starts.
 - PAN/TILT/ZOOM/FOCUS
 - IRIS
 - SHUTTER
 - AGC
 - SENS UP
 - WHITE BALANCE
 - IMAGE HOLD
 - AREA TITLE

- DIGITAL FLIP
- PRIVACY ZONE
- CAMERA ID
- PROPO.PT
- PAN LIMIT
- ZOOM LIMIT
- TILT ANGLE
- CLEANING

After starting the patrol-learn, the following manual operations are stored.

- PAN/TILT/ZOOM/FOCUS operation
- IRIS operation
- Preset positioning

The auto focus function is disabled during the patrol operation. Under such circumstances, the camera goes out of focus when zooming in with WIDE selected resulting from a characteristic of a zoom lens. For storing the zoom operation, start with the TELE mode keeps the camera in focus.

The patrol operation ranges from the horizontal direction to the downward direction. The digital flip function is disabled (page 34).

2. Open the SET UP menu and move the cursor to SPECIAL 1. For PATROL, select LEARN, PLAY or STOP with the joystick.

The factory default setting is STOP.

LEARN: A series of manual operations is stored.

PLAY: Stored operations are reproduced.

STOP: LEARN or PLAY is not activated.

PATROL LEARN with a Controller Having PATROL Button

1. Press the PATROL button and the CAM (SET) button simultaneously to start patrol-learn. The setup menu displays "LEARNING(60S)", and the starting points are stored. (unit: s)

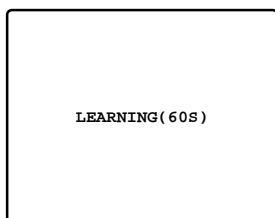

2. Operate patrol-learn manually. The operation data is stored. The countdown to complete learning is displayed.
3. To stop patrol-learn, press the PATROL STOP button.

Patrol-learn with a Controller not Having the PATROL Button

1. Close the SET UP or SPECIAL 1 menu to start PATROL LEARN. Starting point parameters are stored and "LEARNING(60S)" is displayed on the monitor.

2. Operate patrol-learn manually.
3. Open the SET UP menu to stop learning.

Notes:

- It is recommended to set PAN LIMIT to ON for patrol-learn. Otherwise PAN LIMIT is invalid in playback.
- If the power fails in the patrol-learn mode, start the patrol-learn function again from the starting point.
- LEARN also stops 1 minute after starting if the memory is full.
- Auto refreshing may be activated in the patrol play mode or the auto mode to calibrate the lens position.

Patrol Play with a Controller Having the PATROL Button

1. Press the PATROL PLAY button. The camera turns to the starting point and reproduces the operations stored in the memory. Iris operation is valid only in the playback mode.
2. Press the PATROL STOP button and PROGRAM button simultaneously to stop playback or press any manual operation button (e.g., PAN/TILT/ ZOOM/ FOCUS) except the iris buttons.

Patrol Play with a Controller not Having the PATROL Button

1. Select patrol play in the setup menu, and then close the menu. The camera turns to the starting point and the operations stored in memory are reproduced. Iris operation is valid only in the playback mode.
2. Open the SET UP menu, or press any of manual operation buttons (e.g., PAN/TILT/ZOOM/FOCUS) except the iris buttons to stop playback.

Patrol Play with the AUTO PAN Button

1. If the PATROL PLAY function is assigned to the AUTO PAN button, press the AUTO PAN button to turn the camera back to the starting point and to reproduce the operation data stored in the memory.
2. To stop playback, press the PATROL STOP button or any manual operation button (e.g., PAN/TILT/ ZOOM/FOCUS) except the iris buttons.

Notes:

- In the patrol play mode, the camera movement may occasionally deviate from the entered routine when the routine includes a move to a preset position. If this happens, re-enter the routine of manual operations for patrol-learn.
- In the patrol play mode, black and white automatic switching does not work.
- In the patrol play mode, when the power of the controller is turned on or off, the patrol play stops. In this case, press the PATROL PLAY button again. (If SELF RETURN is set to ON, the patrol play will start again after elapsing the setting return time.)

● Alarm Input/Output (ALARM IN/OUT)

Move the cursor to ALARM IN/OUT, and press the CAM (SET) button. The ALARM IN/OUT submenu appears.

** SPECIAL 1 **	
PRIVACY ZONE	OFF ↵
PROPO.P/T	ON
AREA TITLE	ON(USER)↵
PATROL	STOP
ALARM IN/OUT	↵
CLEANING	OFF
EL-ZOOM	ON
PRESET ALM	OFF
IMAGE HOLD	OFF
TILT ANGLE	0°
RET	

Note:

While the camera is in the AF mode or the lens moves between WIDE and TELE, alarm input may be ignored if several alarm inputs are received in succession.

ALARM IN 1-4

Alarm input signals are supplied from external devices through the ALARM IN connector to turn the camera to a preset position.

1. Move the cursor to ALARM IN 1* and select a preset position or OFF with the joystick, then press the CAM (SET) button.
The factory default setting is OFF.

** ALARM IN/OUT **	
ALARM IN 1	OFF
ALARM IN 2	OFF
ALARM IN 3	OFF
ALARM IN 4	OFF
CNT-CLS 1	OFF
TIME OUT	100MS
CNT-CLS 2	OFF
COAX ALM OUT	OFF
RET	

* Set ALARM IN 2, 3 and 4 in the same way as ALARM IN 1.

1 POSI, 2 POSI, 3 POSI and 4 POSI: Preset position. If an alarm input is received, the camera turns to a preset position, and sends an alarm output signal. The position number corresponds to the alarm input number (1-1, 2-2, 3-3 and 4-4).

OFF: The camera ignores alarm inputs.

CNT-CLS 1, 2 (Output)

Two contact closure signals (Open collector type) are output through the Alarm Output connector.

1. Move the cursor to CNT-CLS 1, and select OFF, ALARM or AUX 1 with the joystick.
The factory default setting is OFF.
When ALARM is selected, TIME OUT appears. Select an appropriate duration from among 100 MS, 200 MS, 1000 MS (1 s), 2000 MS (2 s) and 4000 MS (4 s) with the joystick. (unit: s)
The factory default setting is 100 MS. (unit: ms)

Note:

The shorter the duration, the more frequent will be the detection output.

2. Move the cursor to CNT-CLS 2, then select OFF, AUX 2 with the joystick.
The factory default setting is OFF.

OFF: Contact closure signals are deactivated.

ALARM: Available for CNT-CLS 1 only. A motion detection signal is output.

AUX 1(2): An alarm signal is output when the camera receives a command from the controller.

Note:

It is recommended to set the connected external device to ignore the shorter alarm outputs of 90 ms or less from the camera.

COAXIAL ALARM OUT

Alarm output signals are supplied through the coaxial cable.

1. Move the cursor to COAX ALM OUT and select ON or OFF.
2. Press the CAM (SET) button.
The factory default setting is OFF.

ON: The camera sends an alarm output signal after it turns to a preset position.

OFF: The camera does not send an output signal.

Notes:

- The camera ignores alarm inputs during manual operation.
- To download or upload preset data to the system controller, select "OFF".

● Cleaning (CLEANING)

With CLEANING in the ON position, the camera's built-in electromechanical contacts are cleaned at regular intervals (approx. every 7 days).

A dry contact adversely affects picture quality and motors operation.

1. Move the cursor to CLEANING and select ON or OFF with the joystick.

** SPECIAL 1 **	
PRIVACY ZONE	OFF ↵
PROPO.P/T	ON
AREA TITLE	ON(USER)↵
PATROL	STOP
ALARM IN/OUT	↵
CLEANING	ON
EL-ZOOM	ON
PRESET ALM	OFF
IMAGE HOLD	OFF
TILT ANGLE	0°
RET	

ON: The contacts are cleaned for approx. 1 minute. "CLEANING" disappears when the cleaning process is completed.



OFF: No contact cleaning.

Note:

To download or upload preset data to the system controller, set the cleaning function to "OFF". If the cleaning function is activated during the uploading or downloading process, the uploading or downloading fails.

● Electronic Zoom (EL-ZOOM)

The electronic zoom magnifies a scene 10-fold. With a 22-fold optical zoom lens, the camera is capable of 220-fold zoom.

1. Move the cursor to EL-ZOOM and select ON or OFF with the joystick, and then press the CAM (SET) button.

** SPECIAL 1 **	
PRIVACY ZONE	OFF ↵
PROPO.P/T	ON
AREA TITLE	ON(USER)↵
PATROL	STOP
ALARM IN/OUT	↵
CLEANING	ON
EL-ZOOM	ON
PRESET ALM	OFF
IMAGE HOLD	OFF
TILT ANGLE	0°
RET	

ON: 10 - fold electronic zoom is available with the ZOOM switch on the controller.

OFF: The electronic zoom function is not used.

Notes:

- A scene magnified by the electronic zoom function may be inferior in picture quality to a non-magnified one.
- The electronic zoom does not function in the preset position setting mode.
- When trying to set preset positions directly from the WV-CU360 System Controller while ON is set for the electronic zoom function and the displayed scene is magnified at more than x22, the INHIBIT indication will be displayed. In this case, you need to set the electronic zoom function temporarily to OFF.

● Preset Alarm (PRESET ALM)

An alarm output is sent when the camera moves to the designated position depending on the mode.

1. Move the cursor to PRESET ALM and select ON or OFF.

** SPECIAL 1 **	
PRIVACY ZONE	OFF ↵
PROPO.P/T	ON
AREA TITLE	ON(USER)↵
PATROL	STOP
ALARM IN/OUT	↵
CLEANING	OFF
EL-ZOOM	ON
PRESET ALM	ON
IMAGE HOLD	OFF
TILT ANGLE	0°
RET	

ON: Alarm signals are output in the following cases.

- When a preset positioning sequence is completed while AUTO MODE is set to SEQ.
- When a preset positioning sequence is completed while AUTO MODE is set to SORT.
- When the self-return function has returned the camera to its home position.
- Positioning is completed for a position request command.
- Positioning to the designated point is completed for ALARM IN/OUT.
- When positioning to the starting point is completed while AUTO MODE is set to AUTO PAN.
- When positioning to the starting point is completed while PATROL is set to PLAY.

OFF: Alarm signals are not output.

Notes:

- Select OFF when the camera downloads or uploads the preset data.
- When selecting "ON", set "AUTO" for "ALARM DATA" on the RS485 SETUP menu (page 19).

● Image Hold (IMAGE HOLD)

The camera picture remains as a still image on the monitor screen until the camera reaches the preset position. This function is useful for surveillance via local area network.

1. Move the cursor to IMAGE HOLD and select ON or OFF.

** SPECIAL 1 **	
PRIVACY ZONE	OFF ↵
PROPO.P/T	ON
AREA TITLE	ON(USER)↵
PATROL	STOP
ALARM IN/OUT	↵
CLEANING	OFF
EL-ZOOM	ON
PRESET ALM	OFF
IMAGE HOLD	ON
TILT ANGLE	0°
RET	

ON: The last displayed still image is shown till the camera finishes moving to a preset position. However, the still image may be distorted with the effect of panning or tilting.

OFF: The current image is being displayed while the camera is moving to a preset position.

● Tilt Angle (TILT ANGLE 0°/5°)

You can select the tilting range.

1. Move the cursor to TILT ANGLE and select 0° or 5°.

** SPECIAL 1 **	
PRIVACY ZONE	OFF ↵
PROPO.P/T	ON
AREA TITLE	ON(USER)↵
PATROL	STOP
ALARM IN/OUT	↵
CLEANING	OFF
EL-ZOOM	ON
PRESET ALM	OFF
IMAGE HOLD	ON
TILT ANGLE	0°
RET	

0°: The tilting range is between 0° and 180°.

5°: The tilting range is between -5° and 185°.

Note:

When 5° is selected in the WIDE mode, a subject is not displayed on approximately the upper half of the screen or the screen becomes white for some subjects due to the AGC effect.

■ Camera Setting

● To Display the Camera Setting Menu

Move the cursor to CAMERA ↵, and press the CAM (SET) button. The camera setting menu appears.

** SET UP MENU **	
PRESET 1 ↵	
MAP ↵	
HOME POSITION	OFF
SELF RETURN	OFF AT
AUTO MODE	OFF
AUTO PAN KEY	AUTO PAN
DIGITAL FLIP	ON
SPECIAL1 ↵	
CAMERA ↵	
RS485 SET UP ↵	
PASSWORD LOCK	OFF ↵

** SET UP **	
CAMERA ID	OFF ↵
ALC/MANUAL	ALC ↵
SHUTTER	AUTO
AGC	ON(MID)↵
SENS UP	OFF
SYNC	INT
WHITE BAL	ATW1 ↵
MOTION DET	OFF
AF MODE	AUTO L
RET	SPECIAL2 ↵

● Camera Identification (CAMERA ID)

1. Move the cursor to CAMERA ID, and select ON to display the camera identification with the joystick.

** SET UP **	
CAMERA ID	ON ↵
ALC/MANUAL	ALC ↵
SHUTTER	AUTO
AGC	ON(MID)↵
SENS UP	OFF
SYNC	INT
WHITE BAL	ATW1 ↵
MOTION DET	OFF
AF MODE	AUTO L
RET	SPECIAL2 ↵

2. Follow the steps below to edit the camera ID characters.
 - 2-1 Move the cursor to CAMERA ID and press the CAM (SET) button to display the character editing menu.
 - 2-2 Move the cursor to the character you want to edit or change with the joystick, and press the CAM (SET) button. The selected character appears in the editing area.
 - 2-3 Repeat the steps above until all characters are edited.
3. After editing the camera identification characters, follow the steps below to decide the position of CAMERA ID.
 - 3-1 Move the cursor to POSI, and press the CAM (SET) button to display the ID position menu.

```

CAMERA ID —
0123456789
ABCDEFGHIJKLM
NOPQRSTUVWXYZ
( ). , ' " : ; & # ! ? =
+ - * / % $ Å Ü Ö Æ Ñ Å

SPACE
— POSI RET RESET

CAM1.....
↑

```

3-2 Decide the position of the camera ID with the joystick. Press the MON (ESC) button to fix the position, and return to the character editing menu.

Notes:

- When you want the pointer to move to a specific character in the editing area, select a new character, and press the CAM (SET) button. This function allows you to edit or correct a specific character.
- To enter a blank space into the camera ID, move the cursor to SPACE, and press the CAM (SET) button.
- To erase all characters in the editing area, move the cursor to RESET, and press the CAM (SET) button.
- The positioning of CAMERA ID stops at the edges of the screen.
- CAMERA ID moves faster when the joystick is kept at the right or left for one second or more.
- Move the cursor to RET to return to the SET UP menu, and press the CAM (SET) button.

```

CAM1

```

```

CAMERA ID —
0123456789
ABCDEFGHIJKLM
NOPQRSTUVWXYZ
( ). , ' " : ; & # ! ? =
+ - * / % $ Å Ü Ö Æ Ñ Å

SPACE
— POSI RET RESET

CAM1.....
↑

```

```

CAMERA ID —
0123456789
ABCDEFGHIJKLM
NOPQRSTUVWXYZ
( ). , ' " : ; & # ! ? =
+ - * / % $ Å Ü Ö Æ Ñ Å

SPACE
— POSI RET RESET

CAM1.....
↑

```

● Light Control Setting (ALC/MANUAL)

1. Move the cursor to ALC/MANUAL and select ALC or MANUAL with the joystick. When you select ALC, set backlight compensation.

```

** SET UP **
CAMERA ID OFF ↵
ALC/MANUAL ALC ↵
SHUTTER AUTO
AGC ON(MID)↵
SENS UP OFF
SYNC INT
WHITE BAL ATW1↵
MOTION DET OFF
AF MODE AUTO L
RET SPECIAL2 ↵

```

Note:

The backlight compensation submenu associated with this menu is described separately and should be set up after installing the camera at the site and observing the actual site picture.

2. When MANUAL is selected, quit the setup menu by pressing the MON (ESC) button. Press the OPEN or CLOSE button on the controller for iris adjustment.

(1) ALC Mode with BLC ON

1. Press the CAM (SET) button after selecting ALC. The ALC CONT menu appears.

```

** ALC CONT **
BACK LIGHT COMP

BLC OFF
MASK SET ↵
LEVEL .....|.....
- +

RET

```

2. Move the cursor to the BLC parameter and select ON.

```

** ALC CONT **
BACK LIGHT COMP

BLC ON
LEVEL .....|.....
- +

RET

```

3. If you want to adjust the video output level, move the "I" cursor for LEVEL. Adjust it to the desired level with the joystick.
4. Move the cursor to RET and press the CAM (SET) button to return to the CAM SET UP menu.

(2) ALC Mode with BLC OFF

1. Move the cursor to BLC and select OFF. (When you select MANUAL, BLC is not available.) MASK SET appears on the menu.

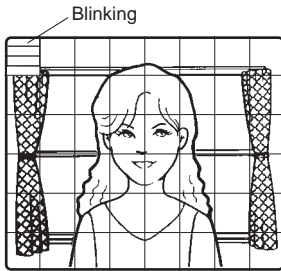

2. Move the cursor to MASK SET and press the CAM (SET) button. The 48 mask areas appear on the monitor screen. The cursor is blinking in the top left corner of the screen.

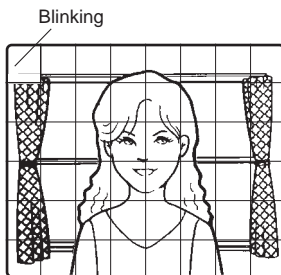

3. To mask an area where backlight is bright, move the cursor to the area and press the CAM (SET) button. The mask turns white. Repeat this procedure to mask the desired areas.

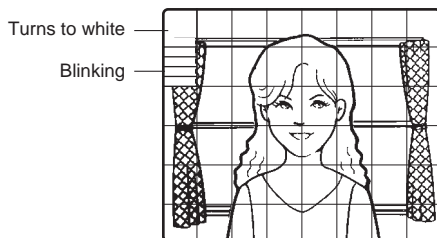

4. To cancel a masked area, move the cursor to the area, and press the CAM (SET) button. To cancel all masking areas, press the F3 button of WV-CU650. For WV-RM70, press the right and left switches simultaneously.
5. After masking is completed, press the MON (ESC) button. The 48 mask areas on the monitor screen disappear and the ALC CONT menu appears.

6. If you want to change the picture contrast, move the "I" cursor for LEVEL and adjust the level.

Note:

If operation of the controller's IRIS (OPEN, CLOSE) buttons during operation is done after the menu is closed, the LEVEL on the CAMERA menu is reflected and stored for these settings. However, if the camera is in a preset position, it is reflected as a parameter of the preset position. To return to the initial factory default level, hold down the system controller's **A** button.

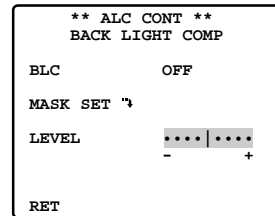

7. Move the cursor to RET and press the CAM (SET) button to return to the CAM SET UP menu.

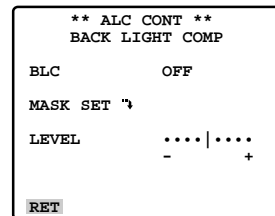

● Shutter Speed Setting (SHUTTER)

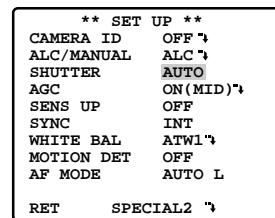

Move the cursor to SHUTTER and select the electronic shutter speed with the joystick. The electronic shutter speed changes as follows with the joystick:

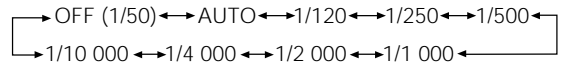

- In the AUTO mode, an object is clearly imaged under highlighted conditions by using the combination technology of iris and shutter functions.

Note:

When the selected shutter speed caused flicker on condition that fluorescent lamps stay on, change this setting to 'OFF'.

● Gain Control [AGC ON (LOW/MID/HIGH)/OFF]

Move the cursor to AGC and select ON (LOW), ON (MID), ON (HIGH) or (OFF) with the joystick.

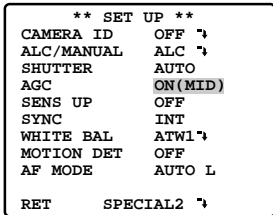

Notes:

- Even if AGC is set to ON and if the noise reduction function is enabled, afterimages may be produced by shooting a moving object or by panning or tilting the camera.
- For more information, refer to Digital Noise Reduction on page 49.

● Electronic Sensitivity Enhancement (SENS UP)

Move the cursor to SENS UP and select the desired electronic sensitivity enhancement mode with the joystick. The electronic sensitivity enhancement mode changes as follows with the joystick:

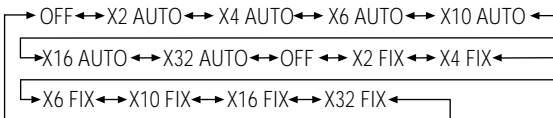
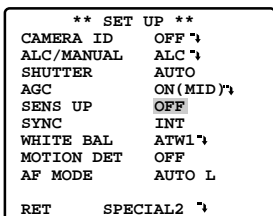

Note:

While the SENS UP function is selected, noise or spots may appear in the picture when the sensitivity of the camera is increased. This is a normal phenomenon.

● Synchronization (SYNC)

Move the cursor to SYNC and select LL or INT with the joystick.

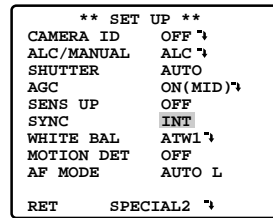

Important Notices:

1. The priorities of SYNC modes are assigned as follows:
 1. Multiplexed vertical drive (VD2) (highest priority)
 2. Line-lock (LL)
 3. Internal sync (INT) (lowest priority)
2. To use internal sync, select INT.
3. Whenever the vertical drive pulse (VD2) is supplied to the camera, the camera sync mode is automatically switched to the multiplexed vertical drive pulse (VD2) regardless of the selected sync mode.

Line-lock Sync Mode (LL)

1. Move the cursor to SYNC and select LL with the joystick. The LL sync mode is not available when the multiplexed vertical drive (VD2) pulse is supplied.
2. After selecting LL, press the CAM (SET) button. The SYNC menu appears on the monitor screen.

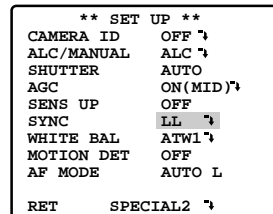

3. Supply the video output signal of the camera to be adjusted and the reference video output signal to a dual-trace oscilloscope.
4. Set the dual-trace oscilloscope to the vertical rate and expand the vertical sync portion on the oscilloscope.

5. Move the cursor to COARSE with the joystick.

```

** SYNC **

V PHASE
COARSE      1(1--16)
FINE        .|.....+
-
RET
  
```

6. Match the vertical phases for both video output signals as closely as possible with the joystick. The coarse adjustment can be performed in steps of 22.5 degrees (16 steps) with the joystick.

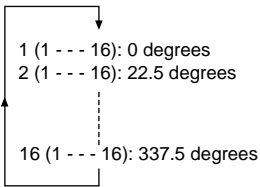

Note:

After the 16th step, the adjustment level returns to the first step.

7. Move the cursor to FINE by using the joystick.

```

** SYNC **

V PHASE
COARSE      1(1--16)
FINE        .|.....+
-
RET
  
```

8. Match the vertical phase for both video output signals as closely as possible with the joystick.

```

** SYNC **

V PHASE
COARSE      4(1--16)
FINE        .....|..+
-
RET
  
```



```

** SYNC **

V PHASE
COARSE      1(1--16)
FINE        .|.....+
-
RET
  
```

Notes:

- When the "|" cursor reaches the "+" end, it jumps back to "-". At the same time, COARSE is incremented by one step to enable a continuous adjustment. The reverse takes place when the "|" cursor reaches the "-" end.
- When the joystick is kept at the right or left for one second or more, the "|" cursor moves quickly.
- To reset COARSE and FINE to the preset values, press the F3 button of WV-CU650. For WV-RM70, press the right and left switches simultaneously. COARSE is preset to zero-crossing of the AC line phase.
- If the AC line phase contains spike noise, etc., the vertical phase of the video output signal may be disturbed.

● **White Balance (WHITE BAL)**

(1) Auto-Tracing White Balance Mode (ATW1/ATW2)

1. Move the cursor to WHITE BAL and select ATW1 with the joystick. The white balance of the camera is automatically adjusted.

```

** SET UP **

CAMERA ID  OFF ↵
ALC/MANUAL ALC ↵
SHUTTER    AUTO
AGC        ON(MID)↵
SENS UP    OFF
SYNC       INT
WHITE BAL  ATW1 ↵
MOTION DET OFF
AF MODE    AUTO L
RET       SPECIAL2 ↵
  
```

2. For fine adjustment of ATW1/ATW2, press the CAM (SET) button. The ATW1/ATW2 fine adjustment menu appears on the monitor screen.

```

** ATW1 **

R          .....|.....+
-
B          .....|.....+
-
RET
  
```

3. Move the cursor to RET with the joystick and press the CAM (SET) button to return to the SET UP menu.

(2) Automatic White Balance Control Mode (AWC)

1. Move the cursor to WHITE BAL and select AWC → PUSH SET with the joystick.

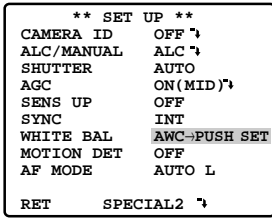

2. Press the CAM (SET) button to start the white balance setup. PUSH SET is highlighted to indicate that white balance is being set.
3. PUSH SET returns to normal when balance setting is completed.
4. For fine adjustment of the AWC, move the cursor to AWC and press the CAM (SET) button. The AWC fine adjustment menu appears on the monitor screen.

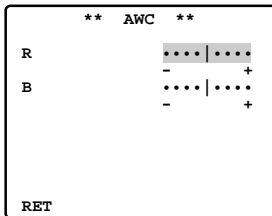

5. Move the cursor to RET with the joystick and press the CAM (SET) button to return to the SET UP menu.

● Motion Detector (MOTION DET)

1. Move the cursor to MOTION DET and select ON or OFF with the joystick.

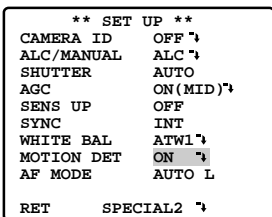

2. If ON is selected, press the CAM (SET) button. The MOTION DETECT menu appears. You can mask the areas in this menu.

3. Move the cursor to MASK SET and press the CAM (SET) button. 48 mask areas appear on the monitor screen. Refer to Light Control Setting on page 43 for masking operations.

4. After masking areas, press the MON (ESC) button. The MOTION DETECT menu appears on the monitor screen.

5. Move the cursor to ALARM and select ON or OFF with the joystick.

ON: The alarm signal is supplied while the display mode is activated.

OFF: The alarm signal is not supplied while the display mode is activated.

6. Move the cursor to DISPLAY MODE. Press the CAM (SET) button to see the present setting. The areas that detect the motions blink.

7. Move the cursor to LEVEL with the joystick. Obtain the optimum detection level with the joystick.

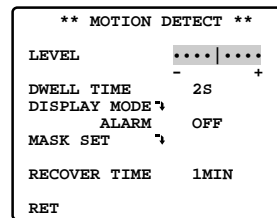

Note:

Repeat the above procedure until you obtain the adjusted results.

8. Dwell Time
Move the cursor to DWELL TIME, and select a time with the Joystick.

When the time specified here elapses after motion detection, the camera will notify the connected device of the alarm activation. The default setting is 2 seconds.

Selectable times (unit: s): 2S, 5S, 10S, 30S

9. Move the cursor to RECOVER TIME with the joystick. You can select the following recover times. (unit: min)

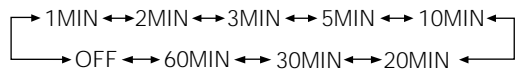

10. Move the cursor to RET and press the CAM (SET) button to return to SET UP.

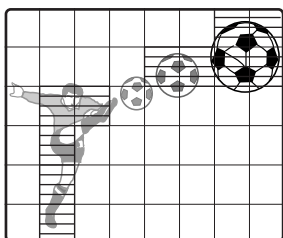
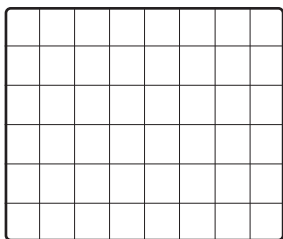

Important Notices:

- The motion detection should meet the following conditions.
 - 1) The picture size on the screen should be larger than 1/48 of the actual picture size.
 - 2) The contrast ratio between the object and the background picture should be more than 5 % at the maximum detection level.
 - 3) The time that takes the object to move from one end of the screen to the other should be more than 0.1 second.
- Also under the following conditions, mask or adjust the detection level to prevent malfunction.
 - 1) When leaves, curtains, etc. are swayed by the wind.
 - 2) When a picture has a high noise content due to low light conditions.
 - 3) When the object is illuminated by lighting equipment that constantly turns on and off.
- The alarm signal will take approx. 0.2 seconds to reach the alarm terminal of the VTR after the camera detects the object.
 Because the alarm signal is multiplexed on the video signal, it may be mistakenly interpreted by other video equipment as a time code signal. Therefore, when this camera is not used in a Panasonic Intelligent CCTV System, select OFF to prevent the above from occurring.

● Auto Focus Setting (AF MODE)

1. Move the cursor to AF MODE, and select the following mode with the joystick. S, M and L stand for Small, Middle and Large areas respectively in the centre of a scene that are used for sensing sharpness in auto-focusing.

** SET UP **	
CAMERA ID	OFF ↵
ALC/MANUAL	ALC ↵
SHUTTER	AUTO
AGC	ON(MID)↵
SENS UP	OFF
SYNC	INT
WHITE BAL	ATW1 ↵
MOTION DET	OFF
AF MODE	AUTO L
RET	SPECIAL2 ↵

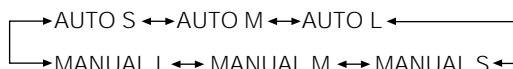

MANUAL S, M, L: Auto focus is activated only when the button that is assigned for the auto-focus function on the controller is pressed.

AUTO S, M, L: Auto focus is activated automatically while the pan, tilt or zoom operation is manually performed. These may be selected in the same way as MANUAL by pressing the button that is assigned for the auto-focus function on the controller.

2. To confirm auto-focus operation, press CAM (SET) button.

Notes:

- When the electronic sensitivity enhancement (SENS UP) is activated except in the x2 FIX or x2 AUTO mode, this function is automatically set to MANUAL (S, M, L).
- The auto focus lens does not function properly in the AUTO mode after using the WIDE lens.
- The auto focus lens may not function properly in the AUTO mode under the following conditions.
 1. Dirt or water on window glass.
The auto focus may focus on the dirt or water.
 2. Low lighting or illumination.
 3. Bright objects or high intensity objects.
 4. Single colour object such as a white wall or fine felt
 5. No centre objects and sloping objects
 6. Far and near objects on the screen

● Special 2 Menu (SPECIAL2)

This menu lets you adjust and set up the picture quality to meet your requirements.

Move the cursor to SPECIAL2 and press the F3 button of WV-CU650. The special menu appears on the monitor screen. For WV-RM70, hold down the right and left switches simultaneously for 2 seconds or more.

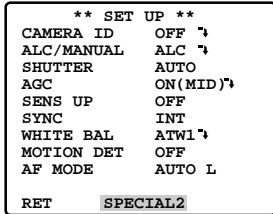

● Chroma Level (CHROMA GAIN) Aperture Level (AP GAIN) Pedestal Level (PEDESTAL)

1. Move the cursor to CHROMA GAIN, and the "I" cursor is highlighted.

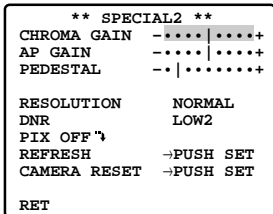

2. Move the "I" cursor to your desired position with the joystick to confirm the level.

Notes:

- For setting the aperture, pedestal and hue levels, perform the same steps described above (but in the step 1, move the cursor to AP GAIN for the aperture level, to PEDESTAL for the pedestal level.).
- To reset the settings to the factory default, press the F3 button of WV-CU650. (For WV-RM70, hold down the right and left switches simultaneously for 2 seconds or more.)

● Resolution (RESOLUTION)

Move the cursor to RESOLUTION and move the joystick to select NORMAL or HIGH.

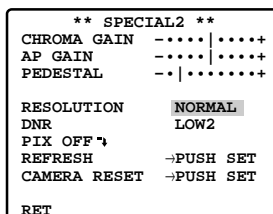

NORMAL: Sets the horizontal resolution to more than 480 lines.

HIGH: Sets the horizontal resolution to more than 510 lines.

Note:

After selecting HIGH, noise may increase when the SENS UP function is activated under low illumination.

● Digital Noise Reduction (DNR)

DNR may be used to improve quality under low light conditions. There are 4 levels of DNR, which may be selected depending on local site conditions. Factory default setting: LOW2

You may need to try different settings to find the most suitable conditions for your application.

Move the cursor to DNR and select LOW1, LOW2, HIGH1 or HIGH2 with the joystick.

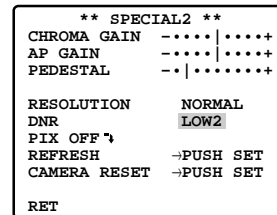

LOW1: DNR level is low. The after-image remains.

LOW2: DNR level is low. The after-image is reduced.

HIGH1: DNR level is high. The after-image remains.

HIGH2: DNR level is high. The after-image is reduced.

● PIX OFF Setting (PIX OFF)

In this setting, you can assign a blemish position and compensate the blemish.

1. Move the cursor to PIX OFF and press the CAM (SET) button. The PIX OFF menu appears.

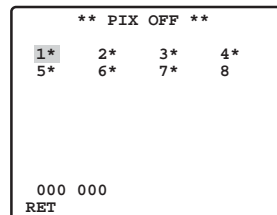

2. Select a number and press the CAM (SET) button. The blemish compensation position setting screen appears.

Move the joystick to place the "+" cursor on the blemish position. After moving the "+" cursor to a position where the blemish looks inconspicuous, press the CAM (SET) button. Consequently, the blemish compensation position is set up and the PIX OFF menu is restored.

After a blemish compensation position is set up, (*) is attached at the right of the number.

- If you would like to delete a blemish compensation position, move the cursor to the applicable number and press the CAM (SET) button.

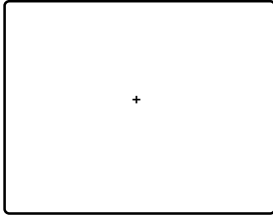

The blemish compensation position setting screen appears. Press the F3 button of WV-CU650 when the setting screen is active.

For WV-RM70, hold down the right and left buttons simultaneously for 2 seconds or more.

For WV-CU161C, hold down the [4] and [6] keys simultaneously for 2 seconds or more.

The screen is restored to the PIX OFF menu, the blemish compensation position is deleted and (*) is also deleted from the right of the number.

• To Restore the Camera Default Position (REFRESH)

Move the cursor to REFRESH with the joystick and press the F3 button of WV-CU650.

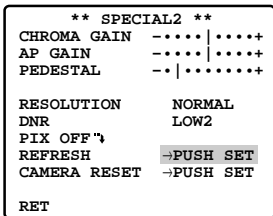

For WV-RM70, hold down the right and left buttons simultaneously for 2 seconds or more.

For WV-CU161C, hold down the [4] and [6] keys simultaneously for 2 seconds or more.

• Camera Resetting (CAMERA RESET)

Move the cursor to CAMERA RESET with the joystick and press the F4 button of WV-CU650.

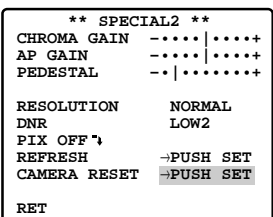

The camera is reset to the factory default settings. (However, the edited settings for PRESET MENU, AUTO PAN, PATROL (SPECIAL 1), PIX OFF (SPECIAL 2) and the registered password will not be reset.)

For WV-RM70, hold down the right, left and set switches simultaneously for 2 seconds or more. For WV-CU161C, hold down the [4], [5] and [6] keys simultaneously for 2 seconds or more.

The ALL RESET indication will be displayed.

Note:

In case of performing this operation on the condition that the cursor is positioned on other than CAMERA RESET, you cannot perform the operations on the menu thereafter. In that event, set the camera menu to ON again with the controller referring to page 26.

• To Close the SPECIAL2 Menu

Move the cursor to RET and press the CAM (SET) button.

The setup menu appears on the monitor screen.

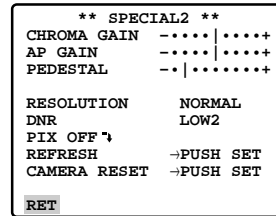

Reset to the Factory Default Settings

Any of the above settings plus the ALC/MANUAL level control and phase adjustments can be reset to the factory default settings by placing the cursor over the desired mode and then pressing the F3 button of WV-CU650.

For WV-RM70, hold down the right and left switches simultaneously for 2 seconds or more.

For WV-CU161C, hold down the [4] and [6] keys simultaneously for 2 seconds or more.

Factory Default Setting

Menu	Item	Setting	Menu	Item	Setting
TOP MENU	HOME POSITION	OFF	PRESET MENU	PRESET ID	ON
	SELF RETURN	OFF		ALC/MANUAL	ALC
	AUTO MODE	OFF		BLC	OFF
	AUTO PAN KEY	AUTO PAN		DWELL TIME	10S
	DIGITAL FLIP	ON		SCENE FILE	1
	PASSWORD LOCK	OFF		PRESET SPEED
SPECIAL 1	PRIVACY ZONE	OFF	SCENE FILE	SHUTTER	AUTO
	PROPO.P/T	ON		AGC	ON (MID)
	AREA TITLE	OFF		SENS UP	OFF
	PATROL	STOP		WHITE BAL	ATW1
	CLEANING	OFF		MOTION DET	OFF
	EL-ZOOM	ON		AF MODE	MANUAL L
	PRESET ALM	OFF	AUTO PAN	SPEED
	IMAGE HOLD	OFF		PAN LIMIT	OFF
	TILT ANGLE	0°		ENDLESS	OFF
CAMERA MENU	CAMERA ID	OFF	RS485 SET UP	DWELL TIME	1S
	ALC/MANUAL	ALC		UNIT NUMBER	1
	BLC	OFF		SUB ADDRESS	1
	SHUTTER	AUTO		BAUD RATE	19200
	AGC	ON (MID)		DATA BIT	8
	SENS UP	OFF		PARITY CHECK	NONE
	SYNC	INT		STOP BIT	1
	WHITE BAL	ATW1		XON/XOFF	NOT USE
	MOTION DET	OFF		WAIT TIME	OFF
AF MODE	AUTO L	ALARM DATA	AUTO2		
SPECIAL 2	CHROMA GAIN	ALARM IN/OUT	DELAY TIME	OFF
	AP GAIN		ALARM IN1	OFF
	PEDESTAL		ALARM IN2	OFF
	RESOLUTION	NORMAL		ALARM IN3	OFF
	DNR	LOW2		ALARM IN4	OFF
				CNT-CLS 1	OFF
				TIME OUT	100MS
				CNT-CLS 2	OFF
				COAX ALM OUT	OFF

SPECIFICATIONS

	WV-CS574E	WV-CS570
Effective Pixels	752 (H) x 582 (V)	
Scanning Area	3.65 mm (H) x 2.71 mm (V), 1/4 in.	
Synchronization	internal/line-lock / multiplexed vertical drive (VD2)	
Horizontal Scanning Frequency	15.625 kHz	
Vertical Scanning Frequency	50.00 Hz	
Video Output	1.0 V[P-P] PAL composite/75 Ω	
Horizontal Resolution	more than 480 lines at centre (C/L, NORMAL), more than 510 lines at centre (C/L, HIGH)	
Vertical Resolution	more than 400 lines at centre	
Signal-to-Noise Ratio	50 dB (AGC OFF, weight on)	
Minimum Illumination	1 lx (0.1 foot-candle) C/L at SENS UP OFF (AGC HIGH)	
Zoom Speed	approx. 4.5 s (TELE/WIDE) in manual mode	
Focus Speed	approx. 5 s (FAR/NEAR) in manual mode	
Iris	automatic (open/close is possible)/manual	
Maximum Aperture Ratio	1 : 1.6 (WIDE) - 3.0 (TELE)	
Focal Length	3.79 - 83.4 mm	
Angular Field of View	H	2.6° - 52.3°
	V	2.0° - 39.9°
Electronic Shutter	1/50 (OFF), AUTO, 1/120, 1/250, 1/500, 1/1 000, 1/2 000, 1/4 000, 1/10 000 s	
AGC	ON (LOW)/ON (MID)/ON (HIGH)/OFF	
Sens Up	MAX 32 times, AUTO/FIX	
BLC	selectable ON/OFF (SETUP MENU)	
Zoom Ratio	x22 +digital zoom x10	
Iris Range	F1.6 - 22, CLOSE	

Power Source	24 V AC, 50 Hz	220 V - 240 V AC, 50 Hz
Power Consumption	13 W	15 W
Ambient Operating Temperature	-10 °C - +50 °C (14 °F - 122 °F) (Recommended operating temperature: +35 °C (95 °F) or less)	
Dimensions	120 (D) x 191 (H) mm (4-3/4" (D) x 7-1/2" (H))	
Weight	approx. 2 kg (4.4 lbs)	

Auto Focus	MANUAL/AUTO
Auto Mode	OFF/SEQ/SORT/AUTO PAN/PATROL
Auto Pan Key	SEQ/SORT/AUTO PAN/PATROL PLAY
Digital Flip	ON/OFF
Camera ID	preset ID, camera ID, area title : up to 16 characters
Motion Detector	ON/OFF
Alarm IN	4 inputs (ALARM IN 1 - 4) pulled up to 5.0 V DC OFF (open or 4 V DC - 5 V DC)/ ON (0 V 0.2 mA)
Alarm OUT	2 outputs (ALARM/AUX1, AUX2) open collector - output max. 16 V DC 100 mA OFF (OPEN)/ON (0 V)
Privacy Zone	ON/OFF, up to 8 zones
Proportional PAN/TILT	ON/OFF
Patrol	LEARN/PLAY/STOP, up to 60 seconds
Cleaning	ON/OFF
Image Hold	ON/OFF

Panning Range	360 ° endless
Panning Angle Setting	possible (in auto-pan mode)
Panning Mode	manual/sequential position/sort position/auto pan
Panning Speed	manual : approx. 0.1 °/s - 120 °/s 8-steps/16-steps/64-steps sequence position : maximum approx. 300 °/s
Tilting Range	0 ° to 180 ° (-5 ° to 185 ° at 5 ° tilt angle setting)
Tilting Mode	manual/sequential position/sort position
Tilting Speed	manual : approx. 0.1 °/s - 120 °/s. 8-steps/16-steps/64-steps sequential position : maximum approx. 300 °/s
Controls	pan/tilt, lens, 32 preset positions, home position

Weights and dimensions indicated are approximate.
Specifications are subject to change without notice.

SHORTCUTS

Shortcuts are supported when you are using the system controller that has a CAM FUNCTION button. With shortcuts, you can configure camera functions by inputting function codes on the 10-key pad and then pressing the CAM FUNCTION button.

The following is a list of all of the shortcuts that are supported by this camera. In addition, you can also move the camera to a preset position by inputting the applicable position number on the 10-key pad.

Notes:

- Turn off digital flip before registering preset positions. If NO REGS.: FLIP ON appears, do the setting again.
- Shortcuts may not be performed if they are executed while a pan, tilt, zoom, or focus operation is in progress.
- Shortcuts 1 through 32, 169, 170 can be saved as part of a patrol routine.
- Except for shortcuts 169 and 170, executing any shortcut during patrol routine PLAY will cause the PLAY operation to stop.

Controller Operation	Setting
[6] + [5] + [CAM FUNCTION]	AUTO PAN ON
[6] + [6] + [CAM FUNCTION]	AUTO PAN OFF
[6] + [7] + [CAM FUNCTION]	Increases AUTO PAN speed one step.
[6] + [8] + [CAM FUNCTION]	Decreases AUTO PAN speed one step.
[6] + [9] + [CAM FUNCTION]	Sets AUTO PAN start point.
[7] + [0] + [CAM FUNCTION]	Sets AUTO PAN end point.
[7] + [1] + [CAM FUNCTION]	AUTO MODE: OFF
[7] + [2] + [CAM FUNCTION]	AUTO MODE: SEQ ON
[7] + [3] + [CAM FUNCTION]	AUTO MODE: SORT ON
[7] + [4] + [CAM FUNCTION]	Reverses AUTO PAN range.
[7] + [6] + [CAM FUNCTION]	ENDLESS: ON
[7] + [7] + [CAM FUNCTION]	ENDLESS: OFF
[7] + [8] + [CAM FUNCTION]	DIGITAL FLIP: ON
[7] + [9] + [CAM FUNCTION]	DIGITAL FLIP: OFF
[8] + [0] + [CAM FUNCTION]	PROPO.P/T: ON
[8] + [1] + [CAM FUNCTION]	PROPO.P/T: OFF
[8] + [4] + [CAM FUNCTION]	BLC: ON
[8] + [5] + [CAM FUNCTION]	BLC: OFF
[8] + [6] + [CAM FUNCTION]	AF MODE: AUTO
[8] + [7] + [CAM FUNCTION]	AF MODE: MANUAL
[8] + [8] + [CAM FUNCTION]	Performs auto focus.
[8] + [9] + [CAM FUNCTION]	Moves to home position.
[9] + [3] + [CAM FUNCTION]	CAMERA ID: ON
[9] + [4] + [CAM FUNCTION]	CAMERA ID: OFF
[9] + [5] + [CAM FUNCTION]	AREA TITLE: ON (NESW)
[9] + [6] + [CAM FUNCTION]	AREA TITLE: ON (USER)
[9] + [7] + [CAM FUNCTION]	AREA TITLE: OFF
[1] + [0] + [0] + [CAM FUNCTION]	Adjusts camera position (REFRESH)
[1] + [0] + [1] + [CAM FUNCTION]	Stores preset to first available preset number (1 to 32).
[1] + [3] + [2] + [CAM FUNCTION]	
[1] + [6] + [5] + [CAM FUNCTION]	PATROL: PLAY
[1] + [6] + [6] + [CAM FUNCTION]	PATROL: STOP
[1] + [6] + [7] + [CAM FUNCTION]	PATROL: LEARN start
[1] + [6] + [9] + [CAM FUNCTION]	IRIS: OPEN

Controller Operation	Setting
[1] + [7] + [0] + [CAM FUNCTION]	IRIS: CLOSE
[1] + [7] + [1] + [CAM FUNCTION]	SHUTTER: ON
[1] + [7] + [2] + [CAM FUNCTION]	SHUTTER: OFF
[1] + [7] + [3] + [CAM FUNCTION]	Increases shutter speed one step.
[1] + [7] + [4] + [CAM FUNCTION]	Decreases shutter speed one step.
[1] + [7] + [5] + [CAM FUNCTION]	AGC: ON
[1] + [7] + [6] + [CAM FUNCTION]	AGC: OFF
[1] + [7] + [7] + [CAM FUNCTION]	SENS UP: FIX ON
[1] + [7] + [8] + [CAM FUNCTION]	SENS UP: FIX OFF
[1] + [7] + [9] + [CAM FUNCTION]	Increases electronic sensitivity enhancement (FIX) one step.
[1] + [8] + [0] + [CAM FUNCTION]	Decreases electronic sensitivity enhancement (FIX) one step.
[1] + [8] + [1] + [CAM FUNCTION]	SENS UP: AUTO ON
[1] + [8] + [2] + [CAM FUNCTION]	SENS UP: AUTO OFF
[1] + [8] + [3] + [CAM FUNCTION]	Increases electronic sensitivity enhancement (AUTO) one step.
[1] + [8] + [4] + [CAM FUNCTION]	Decreases electronic sensitivity enhancement (AUTO) one step.
[1] + [8] + [5] + [CAM FUNCTION]	Increases line lock phase (FINE) one step.
[1] + [8] + [6] + [CAM FUNCTION]	Decreases line lock phase (FINE) one step.
[1] + [8] + [7] + [CAM FUNCTION]	Pans 180°.
[1] + [8] + [8] + [CAM FUNCTION]	CLEANING: ON
[1] + [8] + [9] + [CAM FUNCTION]	CLEANING: OFF

* Do not do this operation with the previous dome type camera models (WV-CS850 series, WV-CS854, WV-CS854E series, WV-CW860 series, WV-CW864, WV-CW864E series, and WV-CS564), doing so may cause a malfunction.

TROUBLESHOOTING

Before requesting service, check the following symptoms to see if you can solve the problem yourself. If the countermeasures described below do not correct the problem, or if the symptoms you are experiencing are not covered here, contact a quality service person or system installer.

Problem	Cause and Recommended Action	Reference Pages
No picture (dark screen)	<ul style="list-style-type: none"> Is the camera connected correctly? Check the operating instructions that come with your system controller. 	-
	<ul style="list-style-type: none"> Is the lens iris closed? Execute the iris reset from the system controller you are using. 	29-30
	<ul style="list-style-type: none"> Is the camera set up for a fixed shutter speed? 	30, 44
White picture	<ul style="list-style-type: none"> Is the lens iris open? 	29-30
	<ul style="list-style-type: none"> Is FIX selected for the electronic sensitivity enhancement (SENS UP) setting? 	30, 45
Out of focus picture	<ul style="list-style-type: none"> Is the dome cover or lens of the camera dirty? If so, clean them. 	6
	<ul style="list-style-type: none"> Is MANUAL selected for the auto focus mode? 	48
	<ul style="list-style-type: none"> Is the object one that is not compatible with auto focus? For such objects, focus manually. 	48
Digital noise in the picture	<ul style="list-style-type: none"> The slip ring may be dirty. Do you have the cleaning function turned on? 	41
	<ul style="list-style-type: none"> Is the camera set up correctly? 	42
Poor picture colour	<ul style="list-style-type: none"> Check the white balance setting. 	46-47
	<ul style="list-style-type: none"> Use the special setup menu to adjust picture quality. 	49
	<ul style="list-style-type: none"> Is the dome cover or lens of the camera dirty? If so, clean them. 	6

Problem	Cause and Recommended Action	Reference Pages
Afterimages in the picture	<ul style="list-style-type: none"> • Check the DNR setting. 	49
White specks in the picture	<ul style="list-style-type: none"> • Use the PIX OFF function to perform blemish compensation. 	49
Menu does not open.	<ul style="list-style-type: none"> • Is the camera connected correctly? See the operating instructions that come with the system controller you are using. 	-
	<ul style="list-style-type: none"> • Are camera communication settings configured correctly? 	11-13 18-19
Menu settings will not change.	<ul style="list-style-type: none"> • Is the password lock function turned on? 	34
I forgot the password.	<ul style="list-style-type: none"> • Contact a quality service person or system installer. 	-
Pan, tilt, zoom, or focus do not work.	<ul style="list-style-type: none"> • Is the camera connected correctly? See the operating instructions that come with the system controller you are using. 	-
	<ul style="list-style-type: none"> • The camera has a pan limit function. Check the PAN LIMIT settings. 	33
	<ul style="list-style-type: none"> • The motor or lens may be worn. Contact a quality service person or system installer. 	-
The camera movement modes (OFF, SEQ, SORT, AUTO PAN, PATROL) do not work.	<ul style="list-style-type: none"> • Check the self return function. 	31
	<ul style="list-style-type: none"> • Check the ALARM IN settings. 	40
	<ul style="list-style-type: none"> • Check the recover time setting of the motion detector. 	30
The camera movement mode (OFF, SEQ, SORT, AUTO PAN, PATROL) setting changes.	<ul style="list-style-type: none"> • Check the self return function. 	31
Camera position is different from the preset position setting.	<ul style="list-style-type: none"> • Perform REFRESH from the special setup menu. 	50

Problem	Cause and Recommended Action	Reference Pages
Picture is different from the position setting.	<ul style="list-style-type: none"> Adjust the picture using the preset menu and a scene file. 	30
Upper part of the picture is black when the camera is in a horizontal orientation.	<ul style="list-style-type: none"> This is caused by the camera's internal cover. It does not indicate malfunction. 	-
Camera suddenly starts to pan by itself.	<ul style="list-style-type: none"> If the cleaning function is turned on, this is normal does not indicate malfunction. Check the CLEANING settings. If the cleaning function is not turned on, this symptom could be due to noise. 	41

● Periodically check the power cord and plug.

Problem	Cause and Recommended Action	Reference Pages
Power cord sheathing is damaged.	<ul style="list-style-type: none"> The power cord, connector, or power plug is damaged. Continued use creates the risk of electric shock and fire. Immediately unplug the power plug and contact a qualified service person or system installer for servicing. 	
Power cord, connectors, or power plug becomes hot during operation.		
Power cord becomes warm or hot when it is bent or stretched during use.		

Information on Disposal for Users of Waste Electrical & Electronic Equipment (private households)



This symbol on the products and/or accompanying documents means that used electrical and electronic products should not be mixed with general household waste.

For proper treatment, recovery and recycling, please take these products to designated collection points, where they will be accepted on a free of charge basis. Alternatively, in some countries you may be able to return your products to your local retailer upon the purchase of an equivalent new product.

Disposing of this product correctly will help to save valuable resources and prevent any potential negative effects on human health and the environment which could otherwise arise from inappropriate waste handling. Please contact your local authority for further details of your nearest designated collection point.

Penalties may be applicable for incorrect disposal of this waste, in accordance with national legislation.

For business users in the European Union

If you wish to discard electrical and electronic equipment, please contact your dealer or supplier for further information.

Information on Disposal in other Countries outside the European Union

This symbol is only valid in the European Union.

If you wish to discard this product, please contact your local authorities or dealer and ask for the correct method of disposal.

Matsushita Electric Industrial Co., Ltd.

Osaka, Japan

<http://www.panasonic.co.jp/global/>

Printed in Japan
Gedruckt in Japan
Imprimé au Japon
Impreso en Japón
Stampato in Giappone
Напечатано в Японии