

Panasonic

Operating Instructions

Video Monitor

Model No. **WV-LW1900/G**
WV-LW2200/G

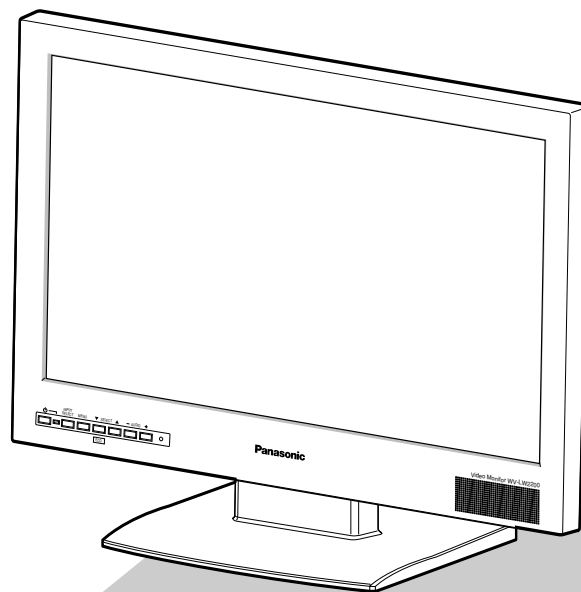

(This illustration represents WV-LW2200/G.)

HDMI[™]
HIGH-DEFINITION MULTIMEDIA INTERFACE

Before attempting to connect or operate this product,
please read these instructions carefully and save this manual for future use.

No model number suffix is shown in this manual.

We declare under our sole responsibility that the product to which this declaration relates is in conformity with the standards or other normative documents following the provisions of Directives 2006/95/EC and 2004/108/EC.

Wir erklären in alleiniger Verantwortung, daß das Produkt, auf das sich diese Erklärung bezieht, mit den folgenden Normen oder normativen Dokumenten übereinstimmt. Gemäß den Bestimmungen der Richtlinie 2006/95/EC und 2004/108/EC.

WARNING:

- This apparatus must be earthed.
- Apparatus shall be connected to a main socket outlet with a protective earthing connection.
- The mains plug or an appliance coupler shall remain readily operable.
- To prevent fire or electric shock hazard, do not expose this apparatus to rain or moisture.
- The apparatus should not be exposed to dripping or splashing and that no objects filled with liquids, such as vases, should be placed on the apparatus.
- All work related to the installation of this product should be made by qualified service personnel or system installers.
- The connections should comply with local electrical code.

CAUTION:

Before attempting to connect or operate this product, please read the label on the bottom.

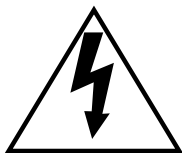

The lightning flash with arrowhead symbol, within an equilateral triangle, is intended to alert the user to the presence of uninsulated "dangerous voltage" within the product's enclosure that may be of sufficient magnitude to constitute a risk of electric shock to persons.



The exclamation point within an equilateral triangle is intended to alert the user to the presence of important operating and maintenance (servicing) instructions in the literature accompanying the appliance.

Power disconnection. Unit with or without ON-OFF switches have power supplied to the unit whenever the power cord is inserted into the power source; however, the unit is operational only when the ON-OFF switch is in the ON position. Unplug the power cord to disconnect the main power for all units.

Nous déclarons sous notre propre responsabilité que le produit auquel se réfère la présente déclaration est conforme aux normes spécifiées ou à tout autre document normatif conformément aux dispositions des directives 2006/95/CE et 2004/108/CE.

Nosotros declaramos bajo nuestra única responsabilidad que el producto a que hace referencia esta declaración está conforme con las normas u otros documentos normativos siguiendo las estipulaciones de las directivas 2006/95/CE y 2004/108/CE.

Noi dichiariamo sotto nostra esclusiva responsabilità che il prodotto a cui si riferisce la presente dichiarazione risulta conforme ai seguenti standard o altri documenti normativi conformi alle disposizioni delle direttive 2006/95/CE e 2004/108/CE.

Wij verklaren als enige aansprakelijke, dat het product waarop deze verklaring betrekking heeft, voldoet aan de volgende normen of andere normatieve documenten, overeenkomstig de bepalingen van Richtlijnen 2006/95/EC en 2004/108/EC.

Vi erklærer os eneansvarlige for, at dette produkt, som denne deklaration omhandler, er i overensstemmelse med standarder eller andre normative dokumenter i følge bestemmelserne i direktivene 2006/95/EC og 2004/108/EC.

Vi deklarerar härmed vårt fulla ansvar för att den produkt till vilken denna deklaration hänvisar är i överensstämmelse med de standarder eller andra normativa dokument som framställs i direktiv nr 2006/95/EC och 2004/108/EC.

Ilmoitamme yksinomaisella vastuullamme, että tuote, jota tämä ilmoitus koskee, noudattaa seuraavia standardeja tai muita ohjeellisia asiakirjoja, jotka noudattavat direktiivien 2006/95/EC ja 2004/108/EC säädöksiä.

Vi erklærer oss alene ansvarlige for at produktet som denne erklæringen gjelder for, er i overensstemmelse med følgende normer eller andre normgivende dokumenter som følger bestemmelsene i direktivene 2006/95/EC og 2004/108/EC.



For U.K.

FOR YOUR SAFETY PLEASE READ THE FOLLOWING TEXT CAREFULLY.

This appliance is supplied with a moulded three pin mains plug for your safety and convenience.

A 5 amp fuse is fitted in this plug.

Should the fuse need to be replaced please ensure that the replacement fuse has a rating of 5 amp and that it is approved by ASTA or BSI to BS1362.

Check for the ASTA mark  or the BSI mark  on the body of the fuse.

If the plug contains a removable fuse cover you must ensure that it is refitted when the fuse is replaced.

If you lose the fuse cover the plug must not be used until a replacement cover is obtained.

A replacement fuse cover can be purchased from your local Panasonic Dealer.

IF THE FITTED MOULDED PLUG IS UNSUITABLE FOR THE SOCKET OUTLET IN YOUR HOME THEN THE FUSE SHOULD BE REMOVED AND THE PLUG CUT OFF AND DISPOSED OF SAFELY. THERE IS A DANGER OF SEVERE ELECTRICAL SHOCK IF THE CUT OFF PLUG IS INSERTED INTO ANY 13 AMP SOCKET.

If a new plug is to be fitted please observe the wiring code as shown below.

If in any doubt please consult a qualified electrician.

WARNING: This apparatus must be earthed.

IMPORTANT

The wires in this mains lead are coloured in accordance with the following code.

Green-and-yellow:	Earth
Blue:	Neutral
Brown:	Live

As the colours of the wire in the mains lead of this appliance may not correspond with the coloured markings identifying the terminals in your plug, proceed as follows.

The wire which is coloured **green-and-yellow** must be connected to the terminal in the plug which is marked with the letter **E** or by the earth symbol  or coloured **green** or **green-and-yellow**.

The wire which is coloured **blue** must be connected to the terminal in the plug which is marked with the letter **N** or coloured **black**.

The wire which is coloured **brown** must be connected to the terminal in the plug which is marked with the letter **L** or coloured **red**.

How to replace the fuse

Open the fuse compartment with a screwdriver and replace the fuse and fuse cover.

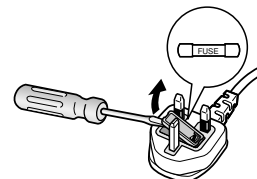

Important Safety Instructions

- 1) Read these instructions.
- 2) Keep these instructions.
- 3) Heed all warnings.
- 4) Follow all instructions.
- 5) Do not use this apparatus near water.
- 6) Clean only with dry cloth.
- 7) Do not block any ventilation openings. Install in accordance with the manufacturer's instructions.
- 8) Do not install near any heat sources such as radiators, heat registers, stoves, or other apparatus (including amplifiers) that produce heat.
- 9) Do not defeat the safety purpose of the polarized or grounding-type plug. A polarized plug has two blades with one wider than the other. A grounding type plug has two blades and a third grounding prong. The wide blade or the third prong are provided for your safety. If the provided plug does not fit into your outlet, consult an electrician for replacement of the obsolete outlet.
- 10) Protect the power cord from being walked on or pinched particularly at plugs, convenience receptacles, and the point where they exit from the apparatus.
- 11) Only use attachments/accessories specified by the manufacturer.
- 12) Use only with the cart, stand, tripod, bracket, or table specified by the manufacturer, or sold with the apparatus. When a cart is used, use caution when moving the cart/apparatus combination to avoid injury from tip-over.



- 13) Unplug this apparatus during lightning storms or when unused for long periods of time.
- 14) Refer all servicing to qualified service personnel. Servicing is required when the apparatus has been damaged in any way, such as power-supply cord or plug is damaged, liquid has been spilled or objects have fallen into the apparatus, the apparatus has been exposed to rain or moisture, does not operate normally, or has been dropped.

Limitation of liability

THIS PUBLICATION IS PROVIDED "AS IS" WITHOUT WARRANTY OF ANY KIND, EITHER EXPRESS OR IMPLIED, INCLUDING BUT NOT LIMITED TO, THE IMPLIED WARRANTIES OF MERCHANTABILITY, FITNESS FOR ANY PARTICULAR PURPOSE, OR NON-INFRINGEMENT OF THE THIRD PARTY'S RIGHT.

THIS PUBLICATION COULD INCLUDE TECHNICAL INACCURACIES OR TYPOGRAPHICAL ERRORS.

CHANGES ARE ADDED TO THE INFORMATION HEREIN, AT ANY TIME, FOR THE IMPROVEMENTS OF THIS PUBLICATION AND/OR THE CORRESPONDING PRODUCT (S).

Disclaimer of warranty

IN NO EVENT SHALL Panasonic Corporation BE LIABLE TO ANY PARTY OR ANY PERSON, EXCEPT FOR REPLACEMENT OR REASONABLE MAINTENANCE OF THE PRODUCT, FOR THE CASES, INCLUDING BUT NOT LIMITED TO BELOW:

- (1) ANY DAMAGE AND LOSS, INCLUDING WITHOUT LIMITATION, DIRECT OR INDIRECT, SPECIAL, CONSEQUENTIAL OR EXEMPLARY, ARISING OUT OF OR RELATING TO THE PRODUCT;
- (2) PERSONAL INJURY OR ANY DAMAGE CAUSED BY INAPPROPRIATE USE OR NEGLIGENT OPERATION OF THE USER;
- (3) UNAUTHORIZED DISASSEMBLE, REPAIR OR MODIFICATION OF THE PRODUCT BY THE USER.

CONTENTS

Important Safety Instructions	3
Limitation of liability	4
Disclaimer of warranty	4
Preface	6
Trademarks and registered trademarks	6
Precautions	6
Precautions for installation	8
Major operating controls and their functions	9
■ Front View	9
■ Rear View	10
Turn on the power	12
Audio Volume Control	13
ECO Mode Activation/Deactivation	14
ECO mode activation	14
ECO mode deactivation	14
Video Adjustment and Setup	15
Video adjustment	15
Screen setup	16
Language in the menus to be displayed	18
Operation time check	19
Installation	20
How to mount monitor stand	20
How to remove monitor stand mounting bracket	20
Screw holes for wall mounting bracket	20
Connections	21
Troubleshooting	23
Specifications	25
Standard Accessories	25
Appearance	26

Preface

This is a video monitor provided with a 19"-type (V) (WV-LW1900) or a 22"-type (V) (WV-LW2200) LCD panel.

- Built-in full high-definition panel (for WV-LW2200)/high-definition panel (for WV-LW1900) with high-speed response
- Supporting HDMI, composite video signal and analog RGB signal for personal computer (PC)
- HDMI, video (480p/720p/1080i/1080p) and audio (1 ch) supported
- Composite video, automatically switchable between NTSC and PAL system
- PC display capacity supporting resolutions from VGA (640 x 480) to SXGA (1280 x 1024). Picture display position can be automatically adjusted.

- Audio input x1 and built-in speaker with max. output of 0.5 W
- On-screen setup menu
- Auto-volt power supply from 100 V AC to 240 V AC
- * The supplied power cord shall be used exclusively for this monitor. To use this product with different power source, replace the power cord
- The screw holes for wall mounting at the rear of this monitor comply with the VESA (Video Electronics Standards Association) standards (100 mm pitch).
- * VESA: Video Electronics Standards Association

Trademarks and registered trademarks

HDMI, the HDMI logo and High-Definition Multimedia Interface are trademarks or registered trademarks of HDMI Licensing LLC.

Precautions

- **Refer all work related to the installation of this product to qualified service personnel or system installers.**
- **Do not block the ventilation opening or slots on the cover.**
- **Do not drop metallic parts through slots.**
This could permanently damage the apparatus. Turn the power off immediately and contact qualified service personnel for service.
- **Do not attempt to disassemble this product.**
To prevent electric shock, do not remove screws or covers.
There are no user-serviceable parts inside. Contact qualified service personnel for maintenance.
- **Do not strike or give a strong shock to this product.**
It may cause damage or allow water to enter this product.

- **Do not expose this product to water or moisture. Do not try to operate it in wet areas.**
Take immediate action if this product gets wet. Turn the power off and refer servicing to qualified service personnel. Moisture can damage this product and also cause electric shocks.
- **Cleaning**
Turn the power off when cleaning the unit. Otherwise it may cause injuries.
Do not use strong or abrasive detergents when cleaning this product body.
Use a dry cloth to clean this product when it is dirty.
When the dirt is hard to remove, use a mild detergent and wipe gently.
- **Do not operate this product beyond its specified temperature, humidity, or power source ratings.**
Use this product under conditions where temperatures are between 0 °C and + 40 °C, and humidity below 90 %.

The input power source for this product is 100 V to 240 V AC, 50 Hz/60 HZ.

* Supplied AC power cord supports 220 V - 240 V AC only.

- **Do not mount this product on places subject to constant vibrations. That may cause trouble or damage.**

- **Use only the supplied power cord.**

- **Be sure to remove this product if it is not in use.**

- **The surface of the LCD Panel is applied by special coating.**

Do not touch or wipe the surface with a hard or abrasive object. Failure to observe this may cause damage to the LCD panel.

- **The LCD panel is made from a very precise technology.**

Some bright and dark spots may exist on the monitor screen.

It is operating normally if there are 99.99 % active pixels.

- **Image persistence may appear on the LCD after a static image with strong contrast is continuously displayed.**

Such a phenomenon is caused by an LCD characteristic. The persistent image will disappear after a period of time.

- **Power switch**

Even though the power switch is turned off, the power supply will not be cut.

Unplug the power cord from the receptacle if this product is not used for a long time. When using the power supply control unit, turn off the power of the power supply control unit.

- **Notations**

Refer to the label on the rear side of this product for the ID, power supply and other notations of this product.

Precautions for installation

Installation work shall be performed in accordance with the technology standard of the electric installation.

Grounding

A grounding connection must be made before connecting the power plug of this product to the main power supply. If a grounded outlet is used, check the ground resistance (100 Ω or less).

Power supply

Be sure to connect to ground prior to connection of the power plug to the main power supply. For disconnection from ground, be sure to disconnect the power plug from the main power supply first. Be sure to connect the power cord via any of the following breaking devices:

- (1) Connect the power cord via a power supply control unit.
- (2) Install this product near an electric outlet, and connect the power cord via the power plug.
- (3) Connect the power cord to the breaker with contact gap of 3.0 mm or more of a distribution board. The breaker should be designed to break the current flows to and from all the electrodes connected to the main power supply except the ground protective conductor.

Installation place

- This product is designed to be used indoors. This product is not operable outdoors.
- Keep the both side surfaces, top surface and rear surface of this product approximately 5 cm away from the wall.
- Do not mount the product on places subject to constant vibrations. That may cause trouble or damage.
- Do not install this product in any place where it will be subjected to direct sunlight for a long time or close to any air conditioning equipment. Failure to observe this may cause deformation, discoloration, failure, or malfunction. Please keep this product away from water droplets or water splashes.
- Avoid the following locations for installation.
 - Locations where it may get wet from rain or water splash
 - Locations where a chemical agent is used such as a swimming pool
 - Locations subject to steam and greasy fumes such as a kitchen and in the special environment of solvents and inflammable gas atmosphere
 - Locations where radiation, x-ray, intense radio wave, or strong magnetism is produced
 - Locations on the sea or by the sea, and locations where a corrosive gas is present

Screwing

- The screws must be tightened with an appropriate tightening torque according to the material and strength of the installation area.
- Do not use an impact driver. Failure to observe this may damage the screw.
- When a screw is tightened, make the screw at a right angle to the surface. After tightening the screws, perform visual check to ensure tightening is enough and there is no backlash.

If this system is not used any more, be sure to dismantle this system.

Major operating controls and their functions

■ Front View

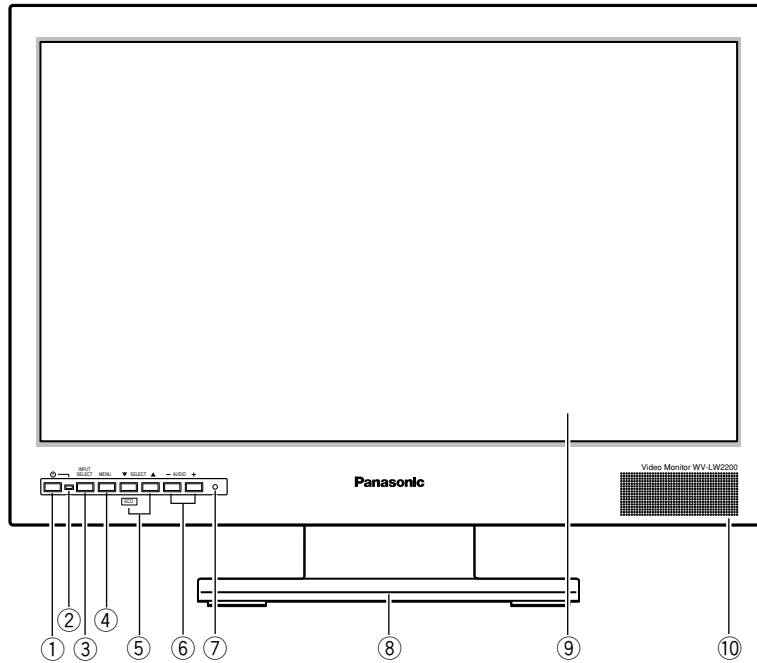

(This illustration represents WV-LW2200.)

① Power button (⏻)

Powers on or off the monitor.

Note:

- Power is supplied via the power cord even while the power button of the monitor set is off.

② Power indicator

This indicator lights green while power is supplied to this monitor and lights orange in the ECO mode (☞ page 14). When this monitor power is turned off, it lights red.

③ Input signal selection button (INPUT SELECT)

Every pressing this button can change input signals as follows.

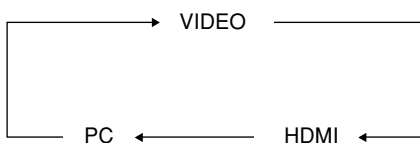

④ Menu button (MENU)

Displays the main menu (☞ page 15). This button is also used to determine the selected parameter in the setup menus.

⑤ Selection buttons (SELECT: ▼, ▲), ECO button

These buttons move the cursor in setup menus.

▼ : Down

▲ : Up

The ▼ button functions as the ECO button other than the setup menus to activate the ECO mode (☞ page 14).

⑥ Audio buttons (AUDIO: +, -)

These buttons adjust the audio volume level. These buttons increments or decrements the selected parameter in setup menus.

⑦ Reset switch

Restarts this monitor.

⑧ Monitor stand

⑨ LCD panel

Take care not to pinch your hands or fingers between the LCD panel and the monitor stand.

⑩ Speaker

■ Rear View

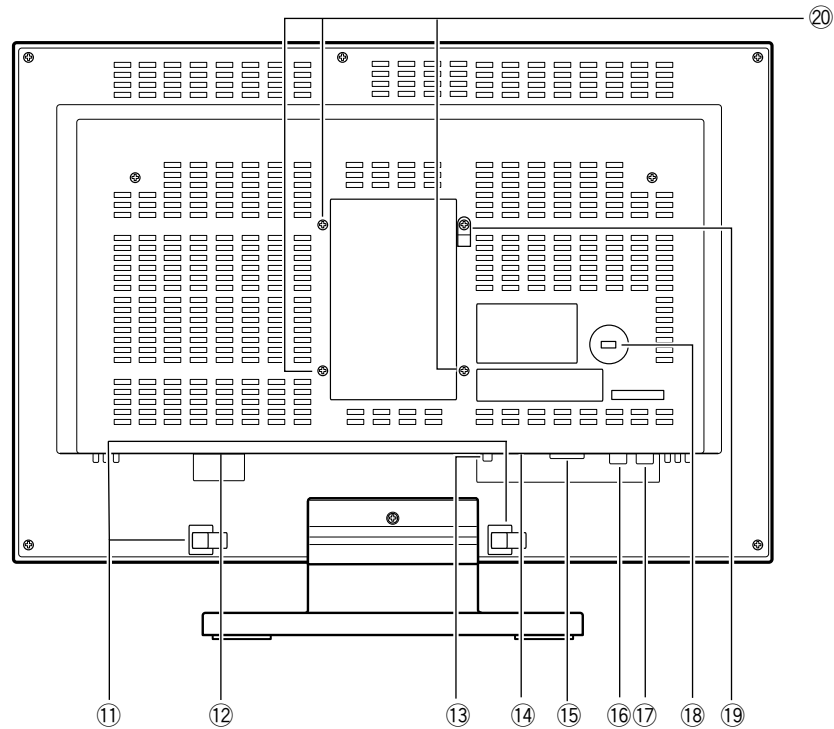

(This illustration represents WV-LW2200.)

⑪ Clamp

After connection of the power cord and HDMI cable, remove the screw that secures the cord clamp and fasten the power cord and HDMI cable.

⑫ Power input jack (AC IN)

Connect the power cord (accessory).

⑬ Audio input connector (AUDIO IN)

With an audio cable connection, this connector accepts an audio signal from an external device and supplies the signal to the built-in speaker.

Note:

- When HDMI is selected for input, audio output is provided not from this terminal but from the HDMI connector.

⑭ HDMI input connector (HDMI)

Accepts an HDMI signal (video/audio) from an external device.

For timing data this connector supports, refer to page 11 "Timing data chart for HDMI input".

⑮ PC input connector (PC IN)

Accepts an analog RGB signal from a PC.

For timing data this connector supports, refer to page 11 "Timing data chart for PC input".

⑯ VIDEO input connector (VIDEO IN)

Accepts a composite video signal from an external device.

⑰ Video output connector (VIDEO OUT)

Supplies a composite video signal accepted by the VIDEO IN connector to another external device.

⑱ Security slot

You can attach a lock that meets the industry standard specification (3 to 3.26 mm x 7 to 7.26 mm x 3.5 to 4 mm).

⑲ Fall-prevention clamp

Use a strong cord or chain (locally procured) to secure this monitor to a solid wall or column for fall prevention. Remove the clamp when a mounting bracket for wall installation is used.

⑳ Screw holes for wall mounting bracket (☞ page 20)

Timing data chart for PC input

This monitor supports the timing data listed as follows. The timing data are partly applicable to the items not listed in the table below.

Resolution	Refresh frequency (Hz)	Horizontal frequency (kHz)	Dot clock frequency (MHz)	Standards
640 x 480	60	31.5	25.175	Industry standard
	72	37.9	31.500	VESA standard
	75	37.5	31.500	VESA standard
800 x 600	56	35.1	36.000	VESA guideline
	60	37.9	40.000	VESA guideline
	72	48.1	50.000	VESA standard
	75	46.9	49.500	VESA standard
1024 x 768	60	48.4	65.000	VESA guideline
	70	56.5	75.000	VESA standard
	75	60.0	78.750	VESA standard
1152 x 864	75	67.5	108.000	VESA standard
1280 x 960	60	60.0	108.000	VESA standard
1280 x 1024	60	64.0	108.000	VESA standard
	75	80.0	135.000	VESA standard
1280 x 720	60	45.0	74.250	VESA standard
1360 x 768	60	47.7	85.500	VESA standard

* VESA: Video Electronics Standards Association

Timing data chart for HDMI input

This monitor supports the timing data listed as follows. The timing data are partly applicable to the items not listed in the table below.

Resolution	Signal type	Refresh frequency (Hz)	Horizontal frequency (kHz)	Dot clock frequency (MHz)	Standards
640 x 480	480p	59.940	31.469	25.175	CEA standard
720 x 480	480i	59.940	15.734	27.000	CEA standard
	480p	59.940	31.469	27.000	CEA standard
720 x 576	576i	50.000	15.625	27.000	CEA standard
	576p	50.000	31.250	27.000	CEA standard
1280 x 720	720p	60.000	45.000	74.250	CEA standard*
		50.000	37.500	74.250	CEA standard
1920 x 1080	1080i	60.000	33.750	74.250	CEA standard*
		50.000	28.125	74.250	CEA standard
	1080p	60.000	67.500	148.500	CEA standard*
		50.000	56.250	148.500	CEA standard

• CEA: Consumer Electronics Association

* CEA considers video timings with the refresh frequencies of 59.940 Hz and 60.000Hz as the equivalent video timing. Exact video timings for 59.940 Hz can be calculated when adjusting numbers listed for 60.000 Hz by a factor of 1000/1001.

Turn on the power

Before operation, check the connections between monitors and external devices (cameras, digital disk recorders, etc.). (page 21)

- 1 Press the power button.
→ The monitor will be powered on, and the power indicator will light up in green.
- 2 Press the INPUT SELECT button. Every pressing this button can change input signals as follows:
→ The signal name will be displayed on the upper right corner of screen for 3 seconds.

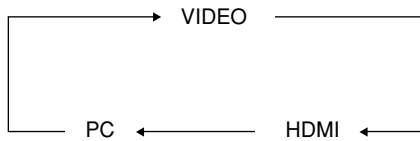

On-screen indication	Input signal type
VIDEO	VIDEO input
HDMI	HDMI input
PCPC input	



When no input signal is supplied to the monitor, "NO SIGNAL" will be displayed on the screen.

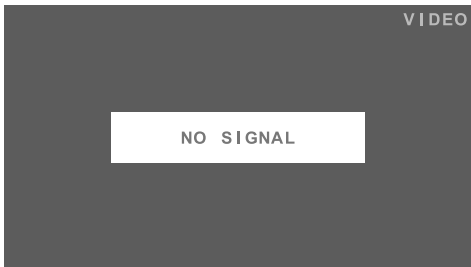

Note:

- The ECO mode (backlight off) (page 14) is automatically activated after no input signal is provided for 10 seconds or more.
- If an input signal is provided in the ECO mode, the backlight automatically lights and the regular mode is activated.
- When the screen display is not proper with the PC input selected, refer to the table in page 11 to perform the output setting of the connected PC.
- If an input signal does not meet the standards (dot clock frequency, horizontal frequency, and vertical frequency), "OUT OF RANGE" will appear on the screen.







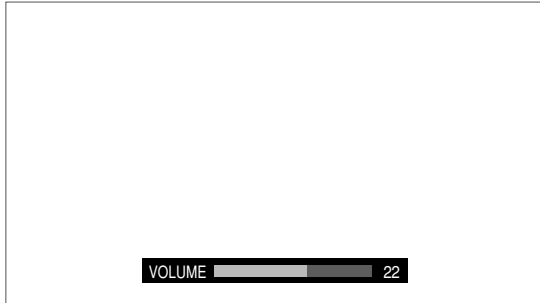

- This monitor can be operated on a plug-and-play basis, however, some settings are configurable on a PC but not displayable on this monitor owing to the restrictions regarding specifications. After ensuring that settings are viewable on this monitor, complete the settings on a PC.

Audio Volume Control

- 1** Pressing the audio buttons (AUDIO -/+) during image display allows users to adjust the audio volume level. When the button is pressed, the volume level appears on the bottom of the screen.
- : Audio volume down
 - + : Audio volume up



Item	Effect	Setting value						
VOLUME	<table border="0"><tr><td>-</td><td>+</td></tr><tr><td></td><td></td></tr><tr><td>Down</td><td>Up</td></tr></table>	-	+			Down	Up	0.....40
-	+							
								
Down	Up							

ECO Mode Activation/Deactivation

The ECO mode is a mode that can reduce the power consumption of this monitor by darkening or completely turning off the backlight of the LCD panel. The power indicator lights orange while the ECO mode is activated.

ECO mode activation

- 1 Press the ▼ button during image display.
→ ECO mode is activated. Every pressing the ▼ button can change modes as follows:

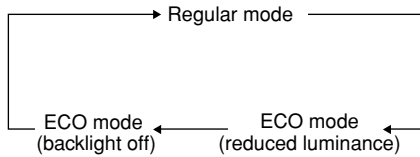

ECO mode deactivation

- 1 Press the ▲ button during image display.
→ The ECO mode is deactivated and the regular mode resumes.

Note:

- Buttons other than ▼ and ▲ buttons can deactivate the ECO mode. However, the function assigned to the button to be pressed is also performed.
Example: Pressing the menu button in the ECO mode deactivates the ECO mode, and then the main menu screen appears.
 - The ECO mode (backlight off) is automatically activated after no input signal is provided for 10 seconds or more.
-

Video Adjustment and Setup

Video adjustment

Adjustment of this monitor will be performed in the VIDEO ADJUST menu. The menu title display differs depending on the selected input signal. Before adjustment, press the INPUT SELECT button surely to select the input signal. (page 9)

- 1 Press the menu button.
→ The top menu will be displayed.



- 2 Use the ▼/▲ buttons to select "VIDEO ADJUST", and press the menu button.
→ The VIDEO ADJUST menu will be displayed.

Present input signals are displayed in the menu title.
VIDEO input: VIDEO
For HDMI input: HDMI
For PC input: PC

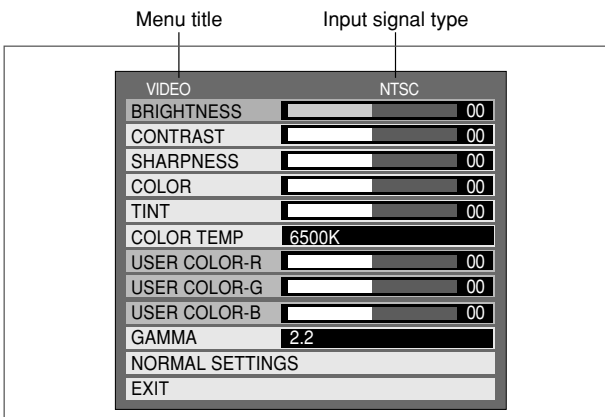

An input signal type appears at the right of the menu title as follows:

- **For VIDEO input**

NTSC : When a video signal input of the NTSC system is entered or if there is no signal

PAL : When a video signal input of the PAL system is entered

- **For HDMI input**

The present signal is displayed in the style of "signal type @ refresh frequency" in accordance with the timing data table (page 11).

- **For PC input**

The present signal is displayed in the style of "resolution @ refresh frequency" in accordance with the timing data table (page 11).

Note:

- The respective setting items are allowed to set up different values in regard to each input signal.
- "SHARPNESS", "COLOR" and "TINT" are not displayed when PC input is provided.
- "TINT" can be adjusted only if the input signal is of the NTSC system or HDMI.

- 3 Use the ▼/▲ buttons to select the item to be adjusted, and press the -/+ buttons to adjust the screen.

Item	Effect	Setting value
BRIGHTNESS	 Dark Bright	-20.....+20
CONTRAST	 Low High	-20.....+20
SHARPNESS (except PC)	 Soft Sharp	-7+7
COLOR (except PC)	 Low High	-20.....+20
TINT (Only for NTSC and HDMI)	 Red Green	-20.....+20
COLOR TEMPERATURE		6500K: Red is intensified. (standard) 9300K: Blue is intensified. User: Depending on the settings of "USER COLOR R", "USER COLOR G" and "USER COLOR B".
USER COLOR R	 Low High	-20.....+20
USER COLOR G	 Low High	-20.....+20
USER COLOR B	 Low High	-20.....+20
GAMMA		2.2: Standard 1.8: Dark portions on images become brighter.

Note:

- [USER COLOR R], [USER COLOR G], and [USER COLOR B] can be adjusted only if [User] has been chosen for [COLOR TEMPERATURE].
-

- 4 To reset the video adjustment to the default, use the ▼/▲ buttons to select "NORMAL SETTINGS" and press the menu button.
→ The settings of only input signals (VIDEO, HDMI, and PC) currently displayed are reset to the factory default.

Screen setup

The image position and size in contradistinction to the LCD panel are adjusted.

- 1 Press the menu button. The main menu screen appears. (☞ page 15)
- 2 Use the ▼/▲ buttons to select "SCREEN SETUP", and press the menu button.
→ The screen setup menu appears.

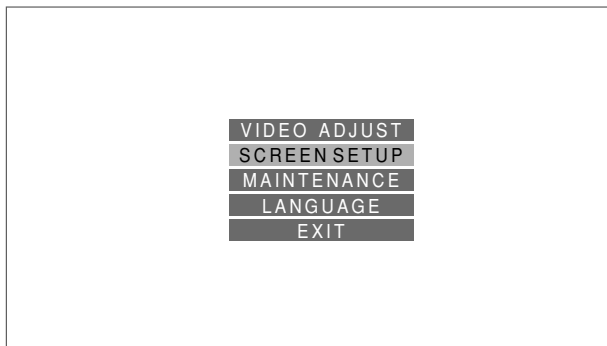

Present input signals are displayed in the menu title.
For VIDEO input: VIDEO
For HDMI input: HDMI
For PC input: PC

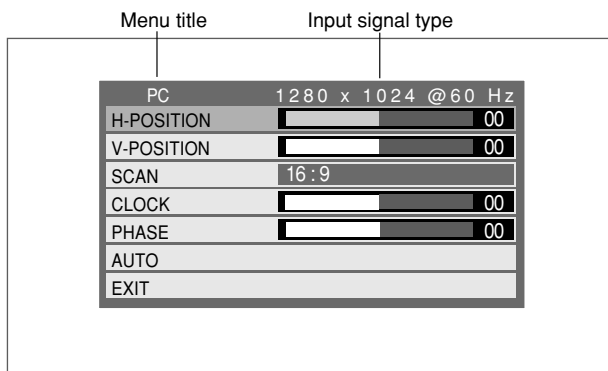

- 5 Select "EXIT", and press the menu button.
→ The main menu screen resumes.

- 6 Select "EXIT" on the main menu screen, and press the menu button.
→ The regular screen resumes.

Note:

- The regular screen automatically resumes after no operation is performed for approximately 10 seconds.
-

An input signal type appears at the right of the menu title as follows:

- **For VIDEO input**

NTSC:When a video signal input of the NTSC system or no signal is provided

PAL : When a video signal input of the PAL system is provided

- **For HDMI input**

The present signal is displayed in the style of "scanning system and refresh frequency" in accordance with the timing data table (☞ page 11).

- **For PC input**

The present signal is displayed in the style of "resolution and refresh frequency" in accordance with the timing data table (☞ page 11).

- 3 Use the ▼/▲ buttons to select "AUTO", and press the menu button.
→ The automatic adjustment starts.

Note:

- The screen flickers during automatic adjustments, but this phenomenon is not a malfunction.
 - Automatic adjustment for VIDEO input makes the scanning ratio 4:3 full.
 - Automatic adjustment takes several seconds to over 10 seconds depending on the conditions of the video signal.
-

If an optimal screen cannot be obtained after automatic adjustment, the following operations may help:

4 Use the ▼/▲ buttons to select the item to be adjusted, and press the -/+ buttons to adjust the screen.

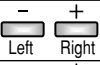
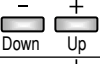
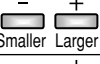
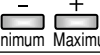
Item	Effect	Setting range
H-POSITION		-40.....+40
V-POSITION (except video)		-20.....+20
CLOCK (only for PC)		-20.....+20
PHASE (only for PC)		0.....+63

5 Select EXIT, and press the menu button.
→ The main menu screen resumes.

6 Select EXIT on the main menu screen, and press the menu button.
→ The regular screen resumes.

Note:

- The regular screen automatically resumes after no operation is performed for approximately 10 seconds.
- When signals are received from a PC, toggling the power on and off activates automatic adjustment.

Note:

- "Clock" and "Phase" are displayed only when PC input is provided.
- "Vertical position" is not displayed when VIDEO input is provided.
- The settings of "Horizontal position" and "Vertical position" for HDMI input range from -10 to +10.
- The setting of "Horizontal position" for VIDEO input range from -10 to +10.

Table of scan settings

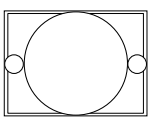
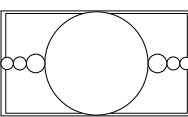
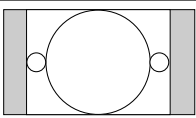
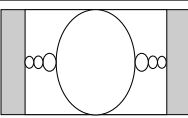
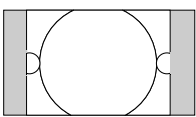
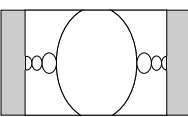
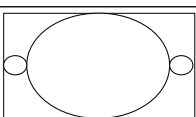
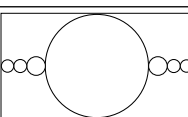
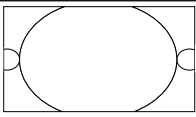
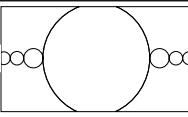
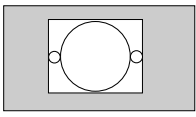
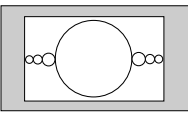
4:3 video signal	16:9 video signal	Selectable scanning ratio			Description
		VIDEO input	HDMI input	PC input	
					
		4:3 full	4:3 full	4:3	The whole image is displayed with the aspect ratio of 4:3. The far-right and far-left portions of the screen are not used.
		4:3 zoom	4:3 zoom	–	The image without surrounding areas is displayed with the aspect ratio of 4:3. The far-right and far-left portions of the screen are not used.
		16:9 full	16:9 full	16:9	The whole image is displayed on the whole screen.
		16:9 zoom	16:9 zoom	–	The image without surrounding areas is displayed on the whole screen.
		–	Dot by dot	Dot by dot	The whole image is displayed with one-to-one relation between image pixel count and screen pixel count. The display size depends on the image pixel count. If the image pixel count is smaller than the screen pixel count, the surrounding areas of the screen are not used. If the image pixel count is larger than the screen pixel count, the image becomes compressed.

Language in the menus to be displayed

A language in the screen is selectable.

- 1 Press the menu button.
→ The main menu appears. (☞ page 15)
- 2 Use the ▼/▲ buttons to select "LANGUAGE", and press the menu button.



→ The language menu appears.



- 3 Use the ▼/▲ buttons to select a language to be used, and press the menu button.
→ The language is selected.
- 4 Select "EXIT", and press the menu button.
→ The main menu screen resumes.

Note:

- When any language other than English is selected, the menu title and "EXIT" are described in the selected language.
-

- 5 Select "EXIT" on the main menu screen, and press the menu button.
→ The regular screen resumes.

Note:

- The regular screen automatically resumes after no operation is performed for approximately 10 seconds or more.
-

Operation time check

The approximate time period of the monitor operation from startup to the present can be viewed.

- 1 Press the menu button.
→ The main menu appears. (☞ page 15)
- 2 Use the ▼/▲ buttons to select "MAINTENANCE", and press the menu button.



→ The number of elapsed years since monitor startup appears.

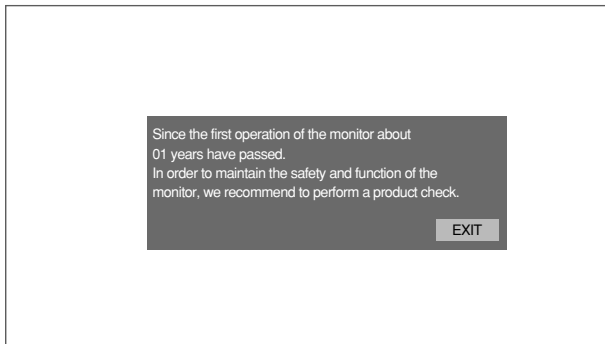

Periodic inspections shall be conducted to use the monitor safely.

Is any of the following phenomena observed?

- Smoke, burnt odor, or unusual sound is detected.
- The power cord or power plug is abnormally hot. A flaw or a scratch is observed.
- An abnormal event or trouble other than the above is observed.

- 3 Press the menu button.
→ The main menu screen resumes.
- 4 Select "EXIT" on the main menu screen, and press the menu button.
→ The regular screen resumes.

Note:

- The regular screen automatically resumes after no operation is performed for approximately 10 seconds.
-

Installation

Important:

- Before installation work, remove all the connected cables and turn off the power of this monitor.
- Do not block the ventilation opening.
- Install this monitor at a vibrationless place. Installation of this monitor at a constantly vibrating place may cause trouble.

How to mount monitor stand

The monitor stand (accessory) is mounted. Use of supplied cushioning protects this monitor from being damaged.

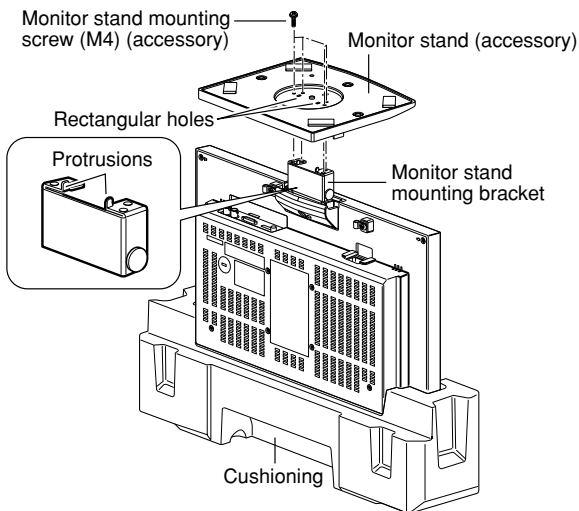

- 1** Mount the monitor stand (accessory) onto the monitor stand mounting bracket. Ensure that the protrusions of the monitor stand mounting bracket pass through the rectangular holes on the bottom face of the monitor stand respectively.
- 2** Use 4 pieces of the monitor stand mounting screws (M4 x 10) (accessories) to secure the monitor stand firmly. Recommended tightening torque: 0.98 N·m {10 kgf·cm}

How to remove monitor stand mounting bracket

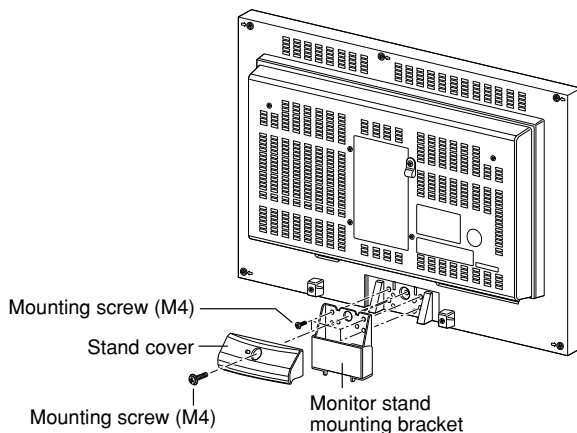

- 1** Remove 1 piece of the stand cover mounting screw (M4 x 15), and then remove the stand cover.
- 2** Remove 4 pieces of the screws (M4 x 15) securing the monitor stand mounting bracket, and then remove the mounting bracket.

Note:

- The removed stand cover, monitor stand mounting bracket and screws should be retained for future use.
- To mount the monitor stand mounting bracket and stand cover again, observe the following recommended tightening torques:
Monitor stand mounting bracket: 0.98 N·m {10 kgf·cm}
Stand cover: 0.784 N·m {8 kgf·cm}

Screw holes for wall mounting bracket

- Check the weights of the wall mounting bracket and this monitor.
- First, check the wall strength of the mounting position because the pull-out strength of the mounting position should be at least 5 times more than the total weight of the wall mounting bracket and this monitor.

Connections

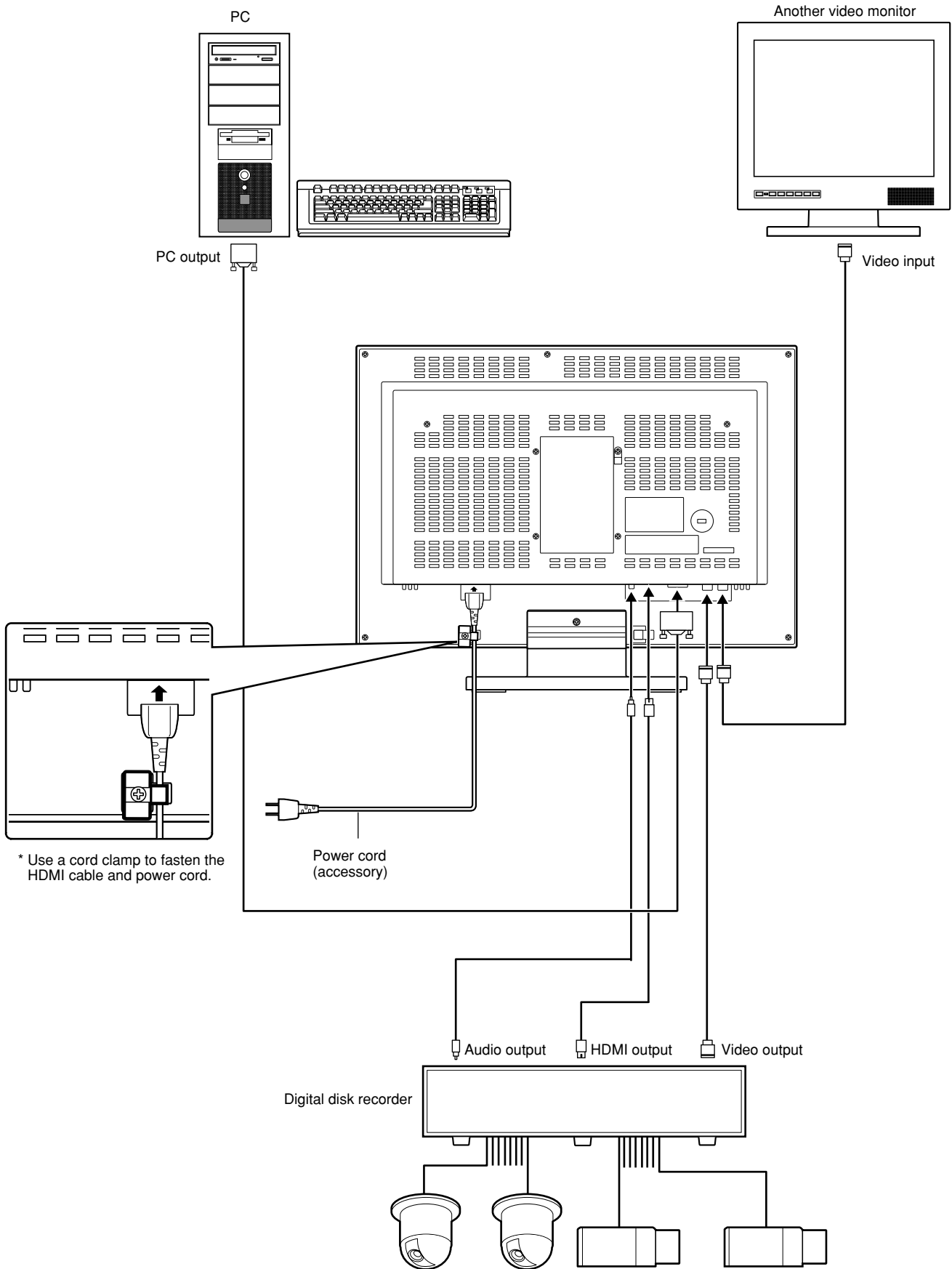

■ Cable connection

To provide VIDEO input, connect the video output to the VIDEO input connector on the rear face of this monitor with a coaxial cable or to the HDMI input connector on the rear face of this monitor with an HDMI cable.

The maximum length of the coaxial cable shall be observed as follows:

Cable type	Length
3C-2V	250 m
5C-2V	500 m
7C-2V	600 m
10C-2V	800 m

The HDMI cable shall be 10 m or less, and an extension cable and a repeater should not be used.

Use of Panasonic HDMI cables is recommended.

■ Connection with two or more video monitors

When plural video monitors are connected, connect the VIDEO input connector of another video monitor to the video output connector of this monitor. Use a coaxial cable for connection.

Up to 10 video monitors can be connected. If 11 or more video monitors are connected, image quality may be degraded. The total length of each cable should not exceed 150 m.

■ Digital disk recorder connection

- To play video:
Connect the video output connector of the digital disk recorder to the VIDEO input connector or HDMI input connector of this monitor with a coaxial cable or an HDMI cable.
- To provide audio input:
Connect the audio output connector of the digital disk recorder to the audio input connector of this monitor with an audio cable.

■ PC connection

Connect the video output (analog RGB) of a PC to the PC input connector of this monitor. The length of a PC cable shall be 3 m or less.

Troubleshooting

Check the following before requesting repair.

Contact your dealer if a problem cannot be solved even after checking and trying the solution, a problem is not described below, or a problem is concerned with installation work.

Problem	Cause · Remedy	Reference page
The power cannot be turned on.	▶ Is the power plug properly connected to the outlet?	–
	▶ Is the power cord fully inserted into the power input jack?	–
"NO SIGNAL" appears in the center of the screen, and no image is displayed.	▶ Are the cables properly inserted into the connectors?	10, 21
	▶ Are the cables connected to the signal-type-compatible input connectors?	10, 21
"OUT OF RANGE" appears in the center of the screen, and no image is displayed.	▶ When the PC input signal is not compliant with the specifications of this monitor, no image is displayed. → Check the specifications of the connected PC.	11, 16
The display position is not proper.	▶ Perform automatic adjustment in the screen setup menu. If the display position is not properly adjusted, perform manual adjustment.	15
No response is observed when the buttons on the front panel are pressed.	▶ <ul style="list-style-type: none"> • Press the reset switch to restart this monitor. • Check the cables are properly inserted into the connectors. 	9, 10
The screen is completely dark, and nothing can be viewed.	▶ When the power indicator lights orange, the ECO mode is active. Press the ▲ button to deactivate the ECO mode.	14
The screen is dim.		
No sound is generated.	▶ <ul style="list-style-type: none"> • Check the cables are properly inserted into the connectors. • When an HDMI input is provided, the audio input connector is disabled. Check the audio setting of the connected HDMI device. 	9

Problem

Cause · Remedy

The power cord insulation is damaged.



The power cord, connectors, or power plug is partly hot during use.



The power cord gets hot when bent or stretched.



- The power cord, connectors, or power plug is damaged.
Continued use of the damaged power cord, connectors, or power plug may cause electric shock or fire.
Remove the power plug from the outlet immediately, and contact the dealer for repair.

Specifications

■ Video monitor

Power source	220 V AC - 240 V AC, 50 Hz/60 Hz
Power consumption	44 W (WV-LW1900), 51 W (WV-LW2200) 1 W or less at power off (power indicator red)
Display panel	18.5 V type (WV-LW1900)/21.6 V type (WV-LW2200) TFT LCD, built-in cold-cathode tube backlight
Display area:	410 mm (W) x 230 mm (H) (WV-LW1900) 478 mm (W) x 269 mm (H) (WV-LW2200)
Number of pixels:	1366 x 768, High- definition (WV-LW1900) 1920 x 1080, Full high-definition (WV-LW2200)
Aspect ratio (width-to-length)	16:9
Maximum brightness	300 cd/m ² (screen center, white)*
Maximum contrast ratio	1 000:1 (screen center)*
Display colors	Approx. 16 700 000 colors
Viewing angle (L/R/U/D)	85°/85°/80°/80° (contrast ratio 10:1)*
Television	Composite input: NTSC/PAL (automatically switchable)
Horizontal resolution	500 or more TV lines
VIDEO input	1.0 V [P-P] composite/75 Ω, BNC connector
Video output	Loop-through output, auto-termination, BNC connector
HDMI input	HDMI standards, digital video/audio signals, type A connector
PC input	R/G/B: 0.7 V [P-P] 75 Ω Horizontal/vertical synchronization: TTL, mini D-sub 15-pin connector
Audio input	-8 dB/Hi-Z, RCA pin jack
Speaker output	0.5 W
Ambient operating temperature	0°C - +40°C
Ambient storage temperature	-20°C - +60°C
Ambient operating humidity	Less than 90 %
Screw holes for wall mounting bracket	100 mm pitch (compliant with VESA standards)
Dimensions	WV-LW1900: 463 mm (W) x 374 mm (H) x 235 mm (D) (monitor stand included) 463 mm (W) x 321 mm (H) x 78 mm (D) (monitor stand excluded) WV-LW2200: 531 mm (W) x 414 mm (H) x 235 mm (D) (monitor stand included) 531 mm (W) x 361 mm (H) x 78 mm (D) (monitor stand excluded)
Weight	WV-LW1900: 7 kg (monitor stand included)/5.6 kg (monitor stand excluded) WV-LW2200: 8 kg (monitor stand included)/6.6 kg (monitor stand excluded)
Finish	Monitor: Solid black metallic Monitor stand: Solid black

* The values are standard values of the LCD panel to be used.

Standard Accessories

Operating Instructions (This Document) 1 pc.

The following parts are used during installation procedures.

Power cord 2 pcs.

Monitor stand 1 pc.

Monitor stand mounting screw..... 4 pcs.

Appearance

WV-LW1900

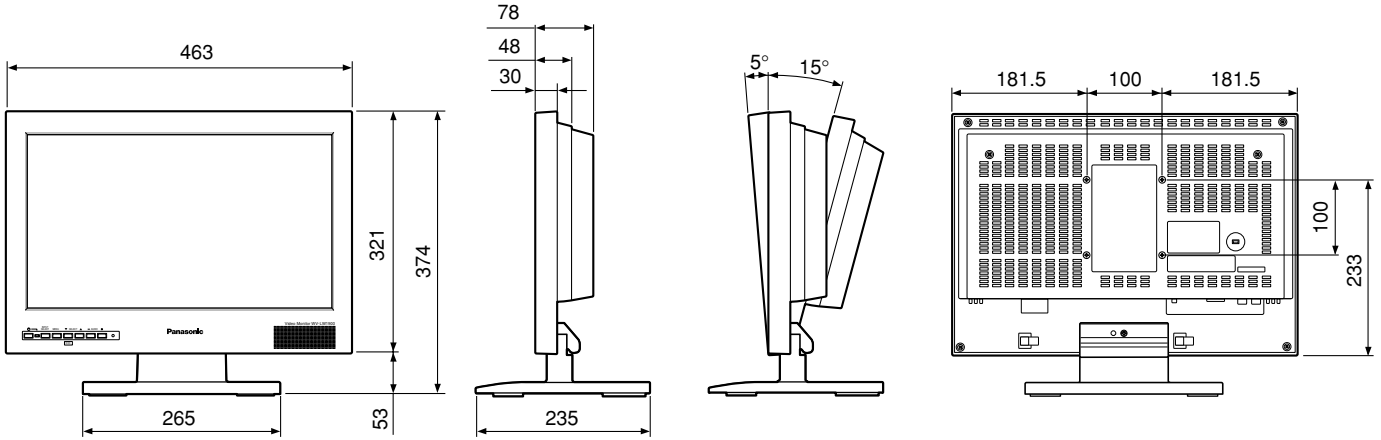

WV-LW2200

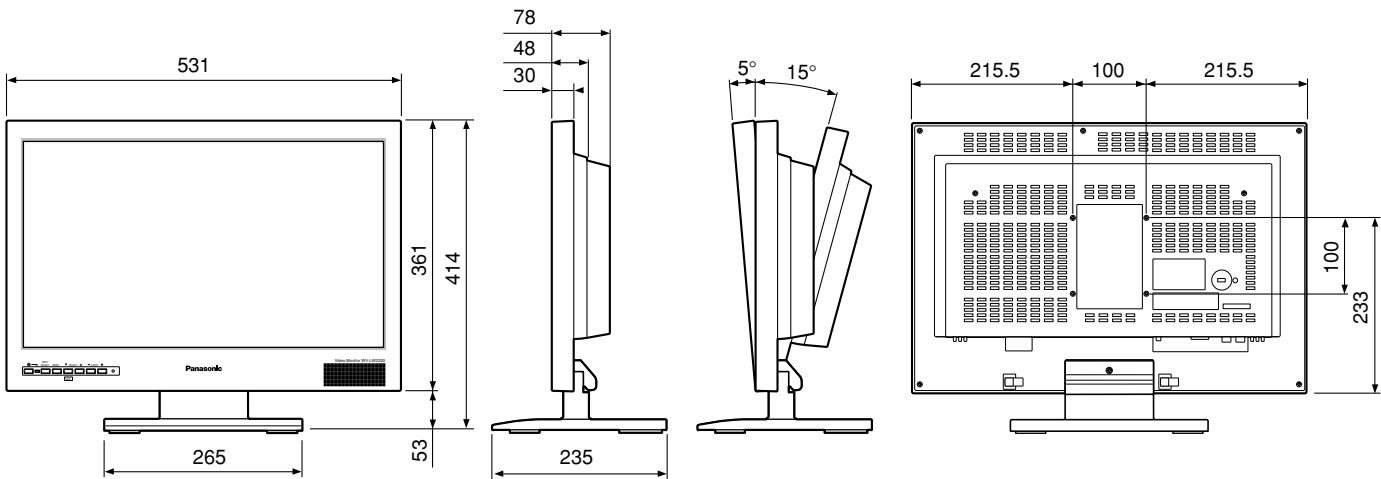

(Unit: mm)

Information on Disposal for Users of Waste Electrical & Electronic Equipment (private households)



This symbol on the products and/or accompanying documents means that used electrical and electronic products should not be mixed with general household waste.

For proper treatment, recovery and recycling, please take these products to designated collection points, where they will be accepted on a free of charge basis. Alternatively, in some countries you may be able to return your products to your local retailer upon the purchase of an equivalent new product.

Disposing of this product correctly will help to save valuable resources and prevent any potential negative effects on human health and the environment which could otherwise arise from inappropriate waste handling. Please contact your local authority for further

details of your nearest designated collection point.

Penalties may be applicable for incorrect disposal of this waste, in accordance with national legislation.

For business users in the European Union

If you wish to discard electrical and electronic equipment, please contact your dealer or supplier for further information.

Information on Disposal in other Countries outside the European Union

This symbol is only valid in the European Union.

If you wish to discard this product, please contact your local authorities or dealer and ask for the correct method of disposal.

Panasonic Corporation

<http://panasonic.net>

Importer's name and address to follow EU rules:

Panasonic Testing Centre
Panasonic Marketing Europe GmbH
Winsbergring 15, 22525 Hamburg F.R.Germany

© Panasonic Corporation 2009

Nt0609-1089 3TR006218BBA Printed in Taiwan