

# Panasonic®

## Operating Instructions AC/Rechargeable Professional Hair Clipper

Model No. ER1411



Before operating this unit, please read these instructions completely and save them for future use.

**Thank you for choosing a Panasonic Hair Clipper. Please read all instructions before use.**

## **Important**

### **► Before use**

This clipper is designed for professional use to trim hair and beards. Charge it for 8 hours before use for the first time in order to activate the built-in rechargeable batteries. It can be operated on either an AC adaptor or rechargeable batteries. Read all instructions carefully before use.

### **► Charging the clipper**

- Do not use any power cord or AC adaptor other than this AC adaptor (RE9-41).
- Avoid charging the batteries at temperatures below 5 °C or above 35 °C.
- Avoid charging the batteries in direct sunlight or near a radiating heat source.
- The charge status (  ) lamp may blink at an early stage when it is used for the first time or if it has not been used for 6 or more months even if it is fully charged. This is not a malfunction.
- Even though the clipper may not be used for an extended period, charge every 6 months to preserve battery life.
- The power cord cannot be replaced. If it is damaged, the AC adaptor should be discarded.

### **► Using the clipper**

- This clipper has a built-in rechargeable battery. Do not throw into fire, apply heat, or charge, use, or leave in a high temperature environment.
- Warning - Keep the appliance dry.
- The clipper may become warm during operation and/or charging. This is normal.
- Check that the blades and the attachments are not damaged before use. Replace them if they are damaged.
- Before each use, apply oil at the places marked with arrows. (See page 6.)
- You should not allow permanent wave lotion, hair restorer or hair spray to come into contact with the main body or the blades. Doing so may result in cracking, discoloring or corrosion.
- You should not drop the clipper on the floor.
- You should not knock the blades and the attachments against hard objects.
- You should not trim the hair of a pet.

### **► Cleaning the clipper**

- Clean the housing using only a cloth slightly dampened with water or a mild soap solution.
- Never use a caustic solution.
- Never submerge the clipper in water.

### ► Storing the clipper

- This appliance is not intended for use by persons (including children) with reduced physical, sensory or mental capabilities, or lack of experience and knowledge, unless they have been given supervision or instruction concerning use of the appliance by a person responsible for their safety. Children should be supervised to ensure that they do not play with the appliance.
- Never tamper with moving parts.
- Do not wrap the appliance by the cord, as it may become detached causing damage or injury.
- If the clipper is not working properly, have it inspected at an authorized service center.

### Specifications

Power source: See the name plate on the product.  
(Automatic voltage conversion)

Motor voltage: 2.4 V DC

Charging time: 1 hour

### Parts identification

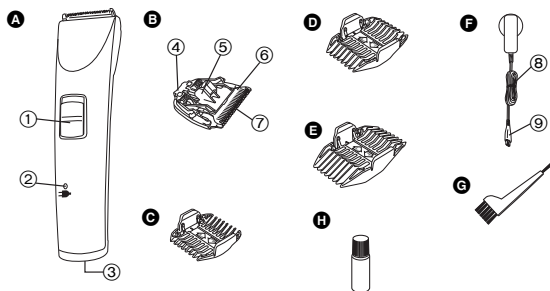

#### A Main body

- ① Power switch [0-CHARGE/1]
- ② Charge status ( → ) lamp
- ③ Appliance socket

#### B Blade

- ④ Mounting hook
- ⑤ Cleaning lever
- ⑥ Moving blade
- ⑦ Stationary blade

#### C 3 mm/6 mm comb attachment

#### D 9 mm/12 mm comb attachment

#### E 15 mm/18 mm comb attachment

#### F AC adaptor (RE9-41)

#### ⑧ Power cord

#### ⑨ Appliance plug

#### G Cleaning brush



#### H Oil

**Charge**

## Charging the hair clipper

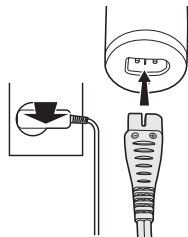
- 1** Slide the power switch to “0-CHARGE”.
- 2** Plug in the AC adaptor into a household outlet.
- 3** Insert the appliance plug into the clipper.



- Charge status (  ) lamp glows in red and charging starts.
- Charging is completed when Charge status (  ) lamp blinks in red once every second. (Max. 1 hour later)
- 10 minutes after charging is completed, the charge status (  ) lamp blinks in red once every 2 seconds.
- 1 full charge will provide approximately 80 minutes of continuous operation.

### ► AC operation

If you connect the AC adaptor to the clipper in the same way as for charging, and turn on the power, you can use it even if the battery capacity is low.

- If the clipper does not operate, charge the clipper for approximately 1 minute.
- Be careful not to discharge the battery completely with the power left turned on. It results in shortening the battery life.

**Cut**

## Using the hair clipper

### ► Using the comb attachments

**1** Select the trimming heights indicated on the insides and sides of the attachments.

**2** Mount the attachment to the clipper as illustrated.

The actual cut length may be longer than the set length.

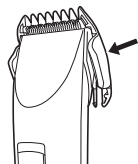

### Removing the attachment from the clipper

Slide one side of the attachment off the mounting in direction indicated with the arrow.

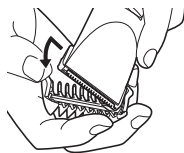

**Care**

## Blade maintenance

### Removing and mounting the blade

#### ► Removing the blade

**1.** Hold the clipper with the power switch facing upward and push the blade with your thumb while catching the blade in your other hand.

- Be sure to turn off the power before you remove the blade.

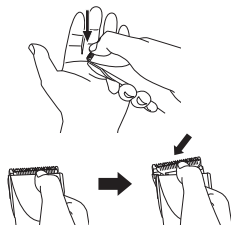

► **Mounting the blade**

1. Fit the mounting hook into the blade mounting on the clipper and push in until it clicks.

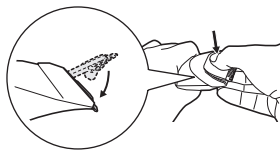

## Cleaning the blade

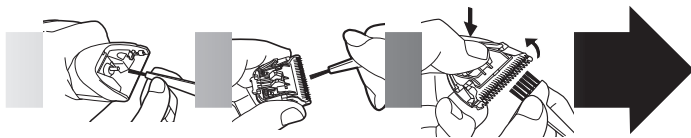

1. Brush off any hairs from the clipper and from around the blade.
2. Remove the blade and brush off the hairs from the blade edge.
3. Brush the hairs out from between the stationary blade and the moving blade while pressing down on the cleaning lever to raise the moving blade.

## Lubrication

1. Apply a few drops of the oil to the space between the stationary blade and moving blade.
  - Apply the oil to the clipper before and after each use.
2. Remount the blade on the clipper.

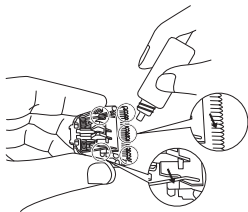

## Removing the built-in rechargeable batteries

Remove the batteries as illustrated.

- Disconnect the clipper from a household outlet.
- Fully discharge the batteries.
- Be careful not to short-circuit the batteries.

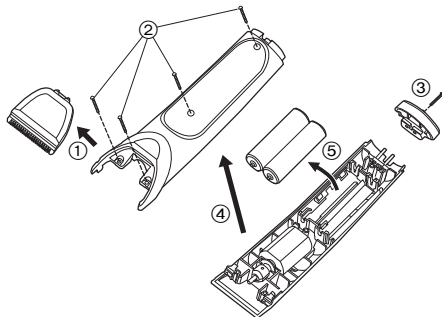

**WARNING** - Do not attempt to replace the batteries for the purpose of reusing the clipper. This could result in the risk of fire or electric shock.

### **Important notice regarding environmental protection**

The built-in rechargeable Nickel-Metal Hydride batteries contain substances that may be environmentally harmful. Please remove the batteries before discarding your clipper.

### **For environmental protection and recycling materials**

This clipper contains Nickel-Metal Hydride batteries.

Please make sure that the batteries are disposed of at an officially assigned location, if there is one in your country.



Panasonic Electric Works Wanbao (Guangzhou) Co., Ltd.  
<http://panasonic.net>

Ⓕ EN

Printed in China  
000000000 X0000-0

