

Panasonic®

Operating Instructions
(Household use) Rechargeable Shaver
Model No. ES-LV6U

Contents

| | | | |
|--------------------------------|----------|--|----|
| Safety precautions..... | 2 | Replacing the system outer foil and the inner blades | 13 |
| Important information | 6 | FAQ | 14 |
| Parts identification | 8 | Troubleshooting | 14 |
| Preparation..... | 8 | Battery life | 16 |
| How to use | 9 | Removing the built-in rechargeable battery | 17 |
| Cleaning the shaver | 12 | Specifications | 18 |



Thank you for purchasing this Panasonic product.

Before operating this unit, please read these instructions completely and save them for future use.

Safety precautions

Make sure to follow these instructions.

To prevent accidents, injuries or damage to property, please follow the instructions below.

- **The following chart indicates the degree of damage caused by improper operation.**

 **DANGER** Indicates a potential hazard that will result in serious injury or death.

 **WARNING** Indicates a potential hazard that could result in serious injury or death.

 **CAUTION** Indicates a potential hazard that could result in minor injury or property damage.

- **The symbols are classified and explained as follows.**

 This symbol indicates prohibition.

 This symbol indicates requirement that must be followed.

WARNING

► This product

This product has a built-in rechargeable battery. Do not throw into fire, apply heat, or charge, use, or leave in a high temperature environment.



- Doing so may cause overheating, ignition, or explosion.

Do not modify or repair.

- Doing so may cause fire, electric shock, or injury.



Contact an authorized service centre for repair (replacement of battery etc).

Never disassemble except when disposing of the product.



- Doing so may cause fire, electric shock, or injury.

WARNING

► In case of an abnormality or malfunction

Immediately stop using and disconnect the AC adaptor.

- Failure to do so may cause fire, electric shock, or injury.

<Abnormality or malfunction cases>



• The main unit, AC adaptor or cord is deformed or abnormally hot.

• The main unit, adaptor or cord smells of burning.

• There is an abnormal sound during use or charging of the main unit.

- Immediately request inspection or repair at an authorized service centre.

► Power supply



Do not connect or disconnect the adaptor to a household outlet with a wet hand.

- Doing so may cause electric shock or injury.

Do not immerse the AC adaptor in water or wash with water.

Do not place the AC adaptor over or near water filled sink or bathtub.

Never use the appliance if the AC adaptor is damaged or if the power plug fits loosely in a household outlet.



Do not damage the cord or the power plug.

• Do not deface, modify, forcefully bend or pull the cord or the power plug. Also, do not place anything heavy on, twist or pinch the cord.

- Doing so may cause electric shock or fire due to a short circuit.

Do not use in a way that would exceed the rating of the household outlet or the wiring.



- Exceeding the rating by connecting too many plugs to one household outlet may cause fire due to overheating.

Do not use anything other than the supplied AC adaptor for any purpose.



Also, do not use any other product with the supplied AC adaptor. (See page 8.)

- Doing so may cause burn or fire due to a short circuit.



Fully insert the power plug.

- Failure to do so may cause fire or electric shock.



Disconnect the AC adaptor when cleaning the main body with water.

- Failure to do so may cause electric shock or injury.

WARNING

-  **Regularly clean the power plug and the appliance plug to prevent dust from accumulating.**
 - Failure to do so may cause fire due to insulation failure caused by humidity.

► **Preventing accidents**

-  **Do not place within reach of children or infants. Do not let them use it.**
 - Putting parts or accessories in the mouth may cause an accident or injury.

If oil is consumed accidentally, do not induce vomiting, drink a large amount of water and contact a physician.

-  **If oil comes into contact with eyes, wash immediately and thoroughly with running water and contact a physician.**
 - Failure to follow these instructions may result in physical problems.

► **Note the following precautions**

-  **This appliance is not intended for use by persons (including children) with reduced physical, sensory or mental capabilities, or lack of experience and knowledge, unless they have been given supervision or instruction concerning use of the appliance by a person responsible for their safety. Children should be supervised to ensure that they do not play with the appliance.**
 - Failure to do so may cause an accident or injury.

-  **The supply cord cannot be replaced. If the cord is damaged, the AC adaptor should be scrapped.**
 - Failure to do so may cause an accident or injury.

CAUTION

► **Protecting the skin**

- Do not use excessive pressure to apply the system outer foil to your lip or other part of your face.**
-  **Do not apply the system outer foil directly to blemishes or injured skin. Do not touch the blade section (metallic section) of the inner blade.**
 - Doing so may cause injury to skin or hand.

CAUTION

Do not forcefully press the system outer foil. Also, do not touch the system outer foil with fingers or nails when in use.



Do not use this product for hair on head or any other part of the body.

- Doing so may cause injury to skin or reduce the life of the system outer foil.



Check the system outer foil for cracks or deformations before use.

- Failure to do so may cause injury to the skin.

► Note the following precautions

Do not allow metal objects or trash to adhere to the power plug or the appliance plug.



- Doing so may cause electric shock or fire due to a short circuit.

Do not share your shaver with your family or other people.



- Doing so may result in infection or inflammation.

Disconnect the adaptor from the household outlet when not charging.



- Failure to do so may cause electric shock or fire due to electrical leakage resulting from insulation deterioration.

Handling of the removed battery when disposing

DANGER

- The rechargeable battery is exclusively for use with this appliance. Do not use the battery with other products.
- Do not charge the battery after it has been removed from the product.
- Do not throw into fire or apply heat.
- Do not hit, disassemble, modify, or puncture with a nail.
- Do not let the positive and negative terminals of the battery get in contact with each other through metallic objects.
- Do not carry or store the battery together with metallic jewellery such as necklaces and hairpins.
- Do not use or leave the battery where it will be exposed to high temperatures, such as under direct sunlight or near other sources of heat.
- Never peel off the tube.
 - Doing so may cause overheating, ignition, or explosion.



WARNING

After removing the rechargeable battery, do not keep it within reach of children and infants.



- The battery will harm the body if accidentally swallowed.

If this happens, consult a physician immediately.

If the battery fluid leaks out and comes in contact with the eyes, do not rub the eyes, and thoroughly rinse with clean water, such as tap water.



- Failure to do so may cause eye injury.

Consult a physician immediately.

CAUTION

If the battery fluid leaks out and comes in contact with the skin or clothes, rinse off with clean water, such as tap water.



- Failure to do so may cause inflammation.

Important information

- This WET/DRY shaver can be used for wet shaving using shaving lather or for dry shaving. You can use this watertight shaver in the shower and clean with water. The following symbol means suitable for use in a bath or shower.



- Treat yourself to wet lather shaves for at least three weeks and notice the difference. Your Panasonic WET/DRY shaver requires a little time to get used to because your skin and beard need about a month to adjust to any new shaving method.
- Keep both the inner blades inserted. If only one of the inner blades is inserted, the shaver may be damaged.
- If you clean the shaver with water, do not use salt water or hot water. Do not soak the shaver in water for a long period of time.
- The following symbol indicates that a specific detachable power supply unit is required for connecting the electrical appliance to the supply mains. The type reference of power supply unit is marked near the symbol.



- Charge the appliance correctly according to these Operating Instructions. (See page 8 "Charging the shaver".)

- This appliance contains battery that is only replaceable by skilled persons. Please contact an authorized service centre for the details of repair.

Note the following precautions

► When using

- Do not bring the system outer foil into contact with hard objects.
Doing so may damage the system outer foil as it is very thin and deforms easily.
- Do not drop or hit against other objects.
Doing so may cause injury.

► When storing

- Store the shaver in a place with low humidity after use.
Failure to do so may cause malfunction due to condensation or rust.
- Be sure to place the protective cap on the shaver when carrying around or storing.
Failure to do so may cause injury to skin or reduce the life of the system outer foil.

► When cleaning

- Do not dry the main unit with a dryer or a fan heater.
Doing so may cause malfunction or deformation of the parts.
- Do not leave the shaver exposed to direct sunlight with the foil frame detached.
Doing so may deteriorate the waterproof rubber and degrade waterproof function, which may cause to malfunction.

Parts identification

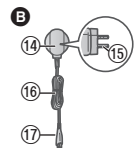
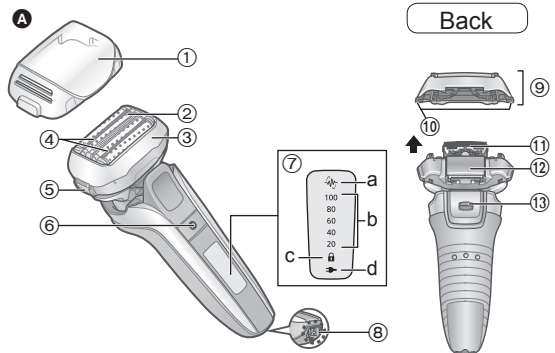

A Main body

- ① Protective cap
- ② System outer foil
- ③ Foil frame
- ④ Smooth rollers
 - They help to glide over the skin more easily.
- ⑤ Foil frame release buttons

- ⑥ Power switch
- ⑦ Lamp display
 - a. Shaving sensor lamp (☼)
 - b. Battery capacity lamp
 - c. Switch lock lamp (🔒)
 - d. Charge status lamp (➔)

- ⑧ Appliance socket
- ⑨ Outer foil section
- ⑩ System outer foil release buttons
- ⑪ Inner blades
- ⑫ Trimmer
- ⑬ Trimmer handle

- B AC adaptor (RE7-87)
 - ⑭ Adaptor
 - ⑮ Power plug
 - ⑯ Cord
 - ⑰ Appliance plug

Accessories

- C Travel case
- D Oil

Preparation

Charging the shaver

- Turn the shaver off.
- Wipe off any water droplets on the appliance socket.

1 Insert the appliance plug into the shaver.

2 Plug the adaptor into a household outlet.

- Check that the charge status lamp (➔) is glowing.
- Charging is completed after approx. 1 hour.

3 Disconnect the adaptor after charging is completed.

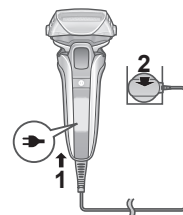

Note

You cannot operate the shaver while charging.

Quick charge

Even though the battery runs out, you can shave once after 3-minute charge.

(This will differ depending on usage.)

While charging



➔ glows.

The number of the battery capacity lamp will increase as charging progresses.

After charging is completed

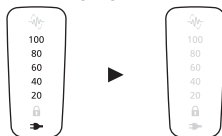

All the battery capacity lamp and ➔ will glow and then turn off after 5 seconds.

Notes

- When charging the shaver for the first time or when it has not been in use for more than 6 months, the charging time may change or the charge status lamp (➔) may not glow for a few minutes. It will eventually glow if kept connected.
- Recommended ambient temperature for charging is 10 °C – 35 °C. It may take longer to charge, or the charge status lamp (➔) will blink quickly and the battery may fail to charge properly in extremely high or low temperatures.

- The shaver can be used for approximately 2 weeks with a full charge.

(Based on one 3-minute dry-shave usage per day in an ambient temperature range of 20 °C – 30 °C.)

The number of usable days varies depending on the following conditions.

- Beard thickness
- Pressure applied to the skin
- Usage frequency of the sonic vibration cleaning mode
- If there is noise from the radio or other sources while using or charging the appliance, move to a different location to use the appliance.

How to use

Shaving beard

1 Press ① and shave.

- The “shaving sensor”, which automatically adjusts the power depending on the beard thickness, will operate.

It will shave with high power on areas where the beard is heavy, and reduce the power on areas where the beard is thin, to reduce burden on the skin.



Tips for better shaving

Apply the whole system outer foil perpendicularly against the skin and shave by slowly gliding the shaver over the face against the grain of the beard.

- The beard under the chin and around the throat can be shaved better by stretching the skin so the beard will stand.
- To prevent damaging the system outer foil, do not shave with only a part of the system outer foil.

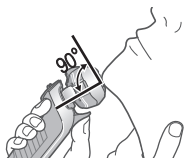

While using

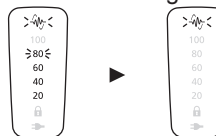

The remaining battery capacity are shown and then turn off after 5 seconds.

- Approximate amount of battery capacity is displayed as 20 - 100.
- The shaving sensor lamp () blinks.

After use

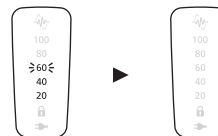

The remaining battery capacity blink and then turn off after 5 seconds.

When the battery capacity is low

- “20” blinks when operating the shaver.
- You can shave 2 to 3 times after “20” blinks. (This will differ depending on usage.)

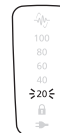

Notes









- The appliance may not operate in an ambient temperature lower than approximately 5 °C.
- The shaving sensor may not respond depending on the type and quantity of the shaving gel. This is not abnormal.

2 Press  when finished.







- Depending on the beard thickness or the amount of beard trimmings in the shaver head, the shaving sensor may not react and the driving sound may not change. This is not abnormal.
- To prevent erroneous operation, place your fingers on the finger rest while using the shaver.
- The sonic vibration cleaning mode is activated when the power switch is pressed for more than 2 seconds while the shaver is not operating. (See page 12.) You cannot shave in this mode.

Operation and display of the switch lock

► Locking the power switch

| | | |
|---|--|---|
| <p>1. Press  once and then release.</p> <ul style="list-style-type: none"> The shaver starts operating.  | <p>2. Press  for more than 2 seconds until the switch lock lamp () turns on.</p> <ul style="list-style-type: none"> The shaver will stop operating.  | <p>3. Release .</p> <ul style="list-style-type: none"> The switch lock lamp () will light up for 5 seconds and turn off.  |
|---|--|---|

► Unlocking the power switch

| | |
|---|--|
| <p>1. Press  for more than 2 seconds until the switch lock lamp () turns off.</p>  | <p>2. Once the shaver starts operating, release .</p> <ul style="list-style-type: none"> The switch lock lamp () will turn off.  |
|---|--|

- The power switch is locked when the switch lock lamp () blinks for 5 seconds and the shaver does not operate even though the power switch is pressed.

► Using the trimmer

- Slide the trimmer handle up to the “mm” position so that the trimmer stands upright.
- Press  and use.

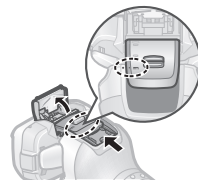

- Press and hold the top knob (a) and slide the trimmer handle down to lower the trimmer.

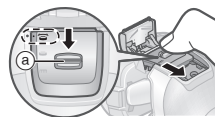

Tips for better usage

Apply the trimmer edge perpendicular to skin gently and move downward slowly.

Trimming sideburns

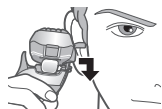

Pre-shave of long beards



► **Switching the shaver head**
You can change the pivot action.

“☎”

The shaver head is moved to prevent missed spots.

“☐”

You can lock the shaver head.

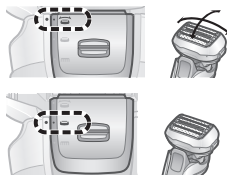

Cleaning the shaver

We recommend cleaning the shaver after each use.

Cleaning with water

- Turn the shaver off and disconnect the AC adaptor.

1 Apply some hand soap and some water to the system outer foil.



2 Press  for more than 2 seconds to activate the sonic vibration cleaning mode.

- Splashing of foam is suppressed.
- The battery capacity lamps blink in order.
- After about 20 seconds, it will be automatically turned off, or you can turn it off by pressing the power switch.

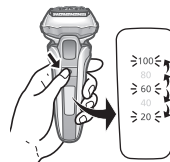

3 Remove the outer foil section and clean with running water.

- See page 13 for removing the outer foil section.
- Splashing is reduced by rinsing the shaver in sonic vibration cleaning mode.
- After rinsing with water, shake the shaver up and down for a few times to remove excess moisture and then wipe off any drops of water with a dry cloth.



4 Dry the outer foil section, the shaver, and the trimmer completely.

- Allow the shaver to dry in the shade, avoid direct sunlight.



5 Lubricate the shaver.

It will keep the movement of the blades smooth and maintain a comfort shave.



1. Apply one drop of oil to each of the system outer foils.
2. Raise the trimmer and apply a drop of oil.
3. Switch the shaver on, and run it for approximately five seconds.
4. Switch off the shaver, and wipe off any excess oil from the system outer foil with a soft cloth.

Notes

- Do not use any kitchen or bathroom detergents other than hand soap.
Doing so may cause malfunction.
- Be careful not to hit the main body on the sink or any other object while draining the water. Failure to do so may cause malfunction.
- Do not wipe with thinners, benzine, alcohol etc.
Doing so may cause malfunction, cracking or discoloration of the parts.
Wipe with diluted soapy water.

Cleaning the system outer foil

Remove the outer foil section.
(See this page.)

Wash the system outer foil in the areas indicated by the circles every time you use the shaver. Otherwise, abnormal sound may be generated.

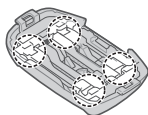

Replacing the system outer foil and the inner blades

| | |
|-------------------|----------------------|
| system outer foil | once every year |
| inner blades | once every two years |

► Removing the outer foil section

Press the foil frame release buttons and lift the outer foil section upwards.

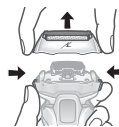

► Attaching the outer foil section

After turning the foil frame mark (ℓ) to the front, securely attach the outer foil section to the shaver until it clicks.

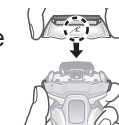

► Replacing the system outer foil

1. Press the system outer foil release buttons and pull down the system outer foil.
 - Do not press the system outer foil release buttons with excessive force.
Doing so may bend the system outer foil, preventing complete attachment to the foil frame.
2. Align the foil frame mark (ℓ) and the system outer foil mark (△) and securely attach together until it clicks.

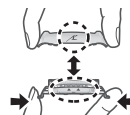

► Replacing the inner blades

1. Remove the inner blades one at a time.
2. Insert the inner blades one at a time.

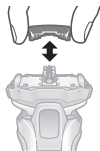

Note

Do not throw away the foil frame.

► Replacement parts

Replacement parts are available at your dealer or Service Centre.

| | | |
|-------------------------------|------------------------------------|---------|
| Replacement parts for ES-LV6U | System outer foil and inner blades | WES9040 |
| | System outer foil | WES9181 |
| | Inner blades | WES9170 |

FAQ

| Question | Answer |
|--|---|
| Will the battery deteriorate if not used for an extended period of time? ► | The battery will deteriorate if not used for over 6 months, so make sure to perform a full charge at least once every 6 months. |

Question

Can I charge the shaver after every use?



The battery used is a lithium-ion, so charging after every use will have no effect on battery life.

Why should the adaptor be disconnected after charge?



Charging the battery for more than 1 hour will not affect battery performance, but disconnect the adaptor for safety and to save energy.

What is the constituent of the dedicated oil?



Constituent of the oil is liquid paraffin.

Why does the appliance beep twice after switched off?



The sound indicates that the battery capacity is running low. Please charge the appliance.

Troubleshooting

Perform the following actions.

If the problems still cannot be solved, contact the store where you purchased the unit or a service centre authorized by Panasonic for repair.

Problem

The power switch does not turn ON.



Action

Unlock the switch lock. (See page 11.)

| Problem | Action |
|--------------------------------------|--|
| The shaving sensor does not respond. | <ul style="list-style-type: none"> ▶ Depending on the beard thickness or the amount of beard trimmings in the shaver head, the shaving sensor may not react and the driving sound may not change. This is not abnormal. |
| | <ul style="list-style-type: none"> ▶ The shaving sensor may not respond depending on the type and quantity of the shaving gel. This is not abnormal. |
| | <ul style="list-style-type: none"> ▶ The shaving sensor may not respond when the remaining battery capacity is low. If this happens, recharge the shaver. |
| | <ul style="list-style-type: none"> ▶ Apply oil. (See page 12.) ▶ The shaving sensor may not respond when there is not enough oil on the blades. |

| Problem | Action |
|---|---|
| The shaving sensor responds even though the shaver is not in contact with the skin. | <ul style="list-style-type: none"> ▶ When the shaver is extremely dirty, remove the foil frame and wash with water. (See page 12.) |
| | <ul style="list-style-type: none"> ▶ Replace the system outer foil and/or inner blades. Expected life of system outer foil and inner blades: System outer foil: Approximately 1 year Inner blades: Approximately 2 years |
| Operating time is short even after a full charge. | <ul style="list-style-type: none"> ▶ Although the shaver can be used for about 2 weeks after a full charge (assuming dry-shave usages for 3 minutes per day), the usable number of days might be lower depending on how the shaver is used (for example, when used for wet shaving). |
| | <ul style="list-style-type: none"> ▶ Apply oil. |
| | <ul style="list-style-type: none"> ▶ Clean the shaver. |
| | <ul style="list-style-type: none"> ▶ When the number of operations per charge starts to decrease, the battery is nearing the end of its life. |

| Problem | Action |
|--|---|
| Shaver does not operate even after charging. | <ul style="list-style-type: none"> ▶ Use the appliance in an ambient temperature approximately 5 °C or higher. ▶ The battery has reached the end of its life. |
| The driving sound changes while shaving. | <ul style="list-style-type: none"> ▶ The shaver will not operate with the AC adaptor connected. Please use the shaver after it has been sufficiently charged and the AC adaptor disconnected. ▶ The shaving sensor is operating. The sound changes depending on the beard thickness. |
| Makes a loud sound. | <ul style="list-style-type: none"> ▶ Apply oil. The blades will not move smoothly when there is no oil on the blades, requiring more power. ▶ The shaver makes a high-pitched sound due to the linear motor drive. This does not indicate a problem. ▶ Confirm that the blades are properly attached. ▶ Wash the system outer foil with water. (See page 12.) |

| Problem | Action |
|--|---|
| The odor is getting stronger. | <ul style="list-style-type: none"> ▶ Clean the shaver. |
| Shavings fly out in all directions. | <ul style="list-style-type: none"> ▶ Clean the inner blades with water when shavings are adhering to the inner blades. ▶ Apply oil. |
| System outer foil gets hot. | <ul style="list-style-type: none"> ▶ Replace the system outer foil if it is damaged or deformed. (See page 13.) ▶ Clean the shaver. ▶ Apply oil. |
| You do not get as close a shave as before. | <ul style="list-style-type: none"> ▶ Replace the system outer foil and/or inner blades. Expected life of system outer foil and inner blades: System outer foil: Approximately 1 year Inner blades: Approximately 2 years |

Battery life

The life of the battery is 3 years. The battery in this shaver is not intended to be replaced by consumers. Have the battery replaced by an authorized service centre.

Removing the built-in rechargeable battery

Remove the built-in rechargeable battery before disposing of the shaver.

The battery is to be disposed of safely.

Please make sure that the battery is disposed of at an officially designated location if there is one.

This figure must only be used when disposing of the shaver, and must not be used to repair it. If you dismantle the shaver yourself, it will no longer be waterproof, which may cause it to malfunction.

- Remove the shaver from the AC adaptor.
- Press the power switch to turn on the power and then keep the power on until the battery is completely discharged.

- Perform steps ① to ⑤ and lift the battery, and then remove it.
- Take care not to short circuit the positive and negative terminals of the removed battery, and insulate the terminals by applying tape to them.

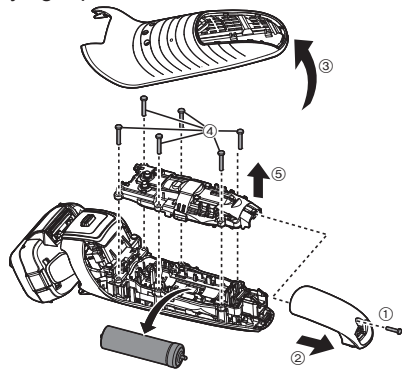

For environmental protection and recycling of materials

This shaver contains a Lithium-ion battery.

Please make sure that the battery is disposed of at an officially assigned location, if there is one in your country.

Specifications

| | |
|---------------|---|
| Power source | See the name plate on the AC adaptor. (Automatic voltage conversion) |
| Motor voltage | 3.6 V $\overline{=}$ |
| Charging time | Approx. 1 hour |

This product is intended for household use only.

Panasonic Corporation
<https://www.panasonic.com>
© Panasonic Corporation 2022