

Operating Instructions Plasma Television



VIERA

Contents

Be Sure to Read

Important Notice	2
Safety Precautions	2

Quick Start Guide

Accessories	5
Connections	7
Identifying Controls	11
First time Auto Tuning	15

Using your VIERA

Operations	16
How to Use eHELP	17
Viewing 3D images	18

Others

FAQs	19
Maintenance	20
Specifications	20

For more detailed instructions, refer to [eHELP]
(Built-in Operating Instructions).

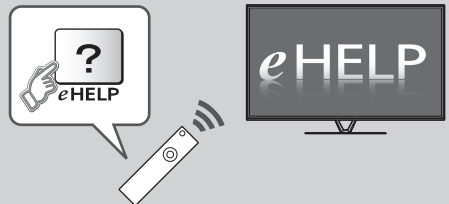

• How to use [eHELP] ➔ (p. 17)



Important Notice

Do not display any still part of the image for a long period

In such cases the still part of the image remains dimly on the plasma screen ("image retention"). This is not considered a malfunction and is not covered by the warranty.

Typical still image parts:

- Channel number, channel logo and other logos
- Still or moving pictures viewed in 4:3 or 14:9 aspect ratio
- Video games



To avoid image retention, the screen saver may be activated (VIERA logo moves) or the on-screen message may move after a few minutes if no signals are sent or no operations are performed.

Panasonic does not guarantee operation and performance of peripheral devices made by other manufacturers; and we disclaim any liability or damage arising from operation and/or performance from usage of such other maker's peripheral devices.

The recording and playback of content on this or any other device may require permission from the owner of the copyright or other such rights in that content. Panasonic has no authority to and does not grant you that permission and explicitly disclaims any right, ability or intention to obtain such permission on your behalf. It is your responsibility to ensure that your use of this or any other device complies with applicable copyright legislation in your country. Please refer to that legislation for more information on the relevant laws and regulations involved or contact the owner of the rights in the content you wish to record or playback.

This product is licensed under the AVC patent portfolio license for the personal and non-commercial use of a consumer to (i) encode video in compliance with the AVC Standard ("AVC Video") and/or (ii) decode AVC Video that was encoded by a consumer engaged in a personal and non-commercial activity and/or was obtained from a video provider licensed to provide AVC Video. No license is granted or shall be implied for any other use.

Additional information may be obtained from MPEG LA, LLC.

See <http://www.mpegla.com>.

Panasonic and its affiliates make no representations or warranties of any kind with respect to the USB devices and the performance of communication between the USB devices and the USB port of Panasonic products, and expressly disclaims any and all warranties, whether express or implied or otherwise, including without limitation any implied warranty of fitness for a particular purpose, any loss of data, and any implied warranties arising from course of dealing or course of performance of data communication between the USB devices and the USB port of Panasonic products.

"Full HD 3D Glasses™" Logo indicates compatibility between TV products and 3D Eyewear which are compliant with the "Full HD 3D Glasses™" format, and does not indicate picture quality of TV products.

Safety Precautions

To help avoid risk of electrical shock, fire, damage or injury, please follow the warnings and cautions below:

■ Mains plug and lead

Warning

If you detect anything unusual, immediately remove the mains plug.



- This TV is designed to operate on AC 220-240 V, 50 / 60 Hz.
- Insert the mains plug fully into the socket outlet.
- Ensure that the mains plug is easily accessible.
- Disconnect the mains plug when cleaning the TV.
- Do not touch the mains plug with wet hands.



- Do not damage the mains lead.
 - Do not place a heavy object on the lead.



- Do not place the lead near a high temperature object.





- Do not pull on the lead. Hold onto the mains plug body when disconnecting the plug.



- Do not move the TV with the lead plugged into a socket outlet.
- Do not twist the lead, bend it excessively or stretch it.
- Do not use a damaged mains plug or socket outlet.
- Ensure the TV does not crush the mains lead.
- Do not use any mains lead other than that provided with this TV.
- Ensure the earth pin on the mains plug is securely connected to prevent electrical shock.
 - An apparatus with CLASS I construction shall be connected to a mains socket outlet with a protective earth connection.

■ Take care

Warning

- Do not remove covers and never modify the TV yourself as live parts are accessible when they are removed. There are no user serviceable parts inside. 
- Do not expose the TV to rain or excessive moisture. This TV must not be exposed to dripping or splashing water and objects filled with liquid, such as vases, must not be placed on top of or above the TV. 
- Do not insert foreign objects into the TV through the air vents.
- Do not use an unapproved pedestal / mounting equipment. Be sure to ask your local Panasonic dealer to perform the setup or installation of approved wall-hanging brackets.
- Do not apply strong force or impact to the display panel.
- Do not place the TV on sloped or unstable surfaces, and ensure that the TV does not hang over the edge of the base. 

Important information

If the TV is not positioned in a sufficiently stable location, it can be potentially hazardous due to falling. Many injuries, particularly to children, can be avoided by taking simple precautions such as:

- Using cabinets or stands recommended by the manufacturer of the TV.
 - Only using furniture that can safely support the TV.
 - Ensuring the TV is not overhanging the edge of the supporting furniture.
 - Not placing the TV on tall furniture (for example, cupboards or bookcases) without anchoring both the furniture and the TV to a suitable support.
 - Not standing the TV on cloth or other materials placed between the TV and supporting furniture.
 - Educating children about the dangers of climbing on furniture to reach the TV or its controls.
- This TV is designed for indoor use.
- Do not expose the TV to direct sunlight and other sources of heat. 

To prevent the spread of fire, keep candles or other open flames away from this product at all times



■ Dangerous part / Small object

Warning

- This product contains possibly dangerous parts such as plastic bags, that can be breathed in or swallowed by young children accidentally. Keep these parts out of reach of young children.
- Do not allow children to handle any small objects such as SD Card. The small object could be swallowed by young children. Remove SD Card immediately after use and store out of reach of young children. 
- 3D Eyewear and Electronic Touch Pen contain small parts that can be swallowed by young children accidentally. Keep these parts out of reach of young children.

■ Pedestal

Warning

- Do not disassemble or modify the pedestal.

Caution

- Do not use any pedestal other than the one provided with this TV.
- Do not use the pedestal if it becomes warped or physically damaged. If this occurs, contact your nearest Panasonic dealer immediately.
- During setup, make sure that all screws are securely tightened.
- Ensure that the TV does not suffer any impact during installation of the pedestal.
- Ensure that children do not climb onto the pedestal.
- Install or remove the TV from the pedestal with at least two people.
- Install or remove the TV by the specified procedure.

■ Radio wave

Warning

- Do not use the TV, 3D Eyewear, Electronic Touch Pen and VIERA Touch Pad Controller in any medical institutions or locations with medical equipment. Radio waves may interfere with the medical equipment and cause accidents due to the malfunction.
- Do not use the TV, 3D Eyewear, Electronic Touch Pen and VIERA Touch Pad Controller near any automatic control equipment such as automatic doors or fire alarms. Radio waves may interfere with the automatic control equipment and cause accidents due to the malfunction.
- Keep the distance at least 22 cm from the TV, 3D Eyewear, Electronic Touch Pen and VIERA Touch Pad Controller when you have a cardiac pacemaker. Radio waves may interfere with the operation of the pacemaker.
- Do not disassemble or alter the TV, 3D Eyewear, Electronic Touch Pen and VIERA Touch Pad Controller in any way.

■ Built-in wireless LAN

Caution

- Do not use the built-in wireless LAN to connect to any wireless network (SSID*) for which you do not have usage rights. Such networks may be listed as a result of searches. However, using them may be regarded as illegal access.
*SSID is a name for identifying a particular wireless network for transmission.
- Do not subject the built-in wireless LAN to high temperatures, direct sunlight or moisture.
- Data transmitted and received over radio waves may be intercepted and monitored.
- The built-in wireless LAN uses 2.4 GHz and 5 GHz frequency bands. To avoid malfunctions or slow response caused by radio wave interference, keep the TV away from the devices such as other wireless LAN devices, microwaves, mobile phones and the devices that use 2.4 GHz and 5 GHz signals when using the built-in wireless LAN.
- When noises occur due to the static electricity, etc., the TV might stop operating for the protection of the devices. In this case, turn the TV off with Mains power On / Off switch, then turn it on again.
- Additional information for the wireless LAN and access point may be on the following website.
<http://panasonic.net/viera/support>

■ Bluetooth® wireless technology

Caution

- The TV, 3D Eyewear, Electronic Touch Pen and VIERA Touch Pad Controller use the 2.4 GHz radio frequency ISM band (Bluetooth®). To avoid malfunctions or slow response caused by radio wave interference, keep the TV, 3D Eyewear, Electronic Touch Pen and VIERA Touch Pad Controller away from the devices such as other wireless LAN devices, other Bluetooth devices, microwaves, mobile phones and the devices that use 2.4 GHz signal.

■ Ventilation

Caution

Allow sufficient space around the TV in order to help prevent excessive heat, which could lead to early failure of some electronic components.

Minimum distance:

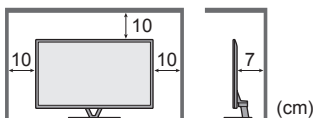

- Ventilation should not be impeded by covering the ventilation openings with items such as newspapers, tablecloths and curtains.
- Whether you are using a pedestal or not, always ensure the vents at the bottom of the TV are not blocked and there is sufficient space to enable adequate ventilation.



■ Moving the TV

Caution

Before moving the TV, disconnect all cables.

- The TV is heavy. Move the TV with at least two people. Support as shown to avoid injury by the TV tipping or falling.



- Transport only in upright position. Transporting the TV with its display panel facing upwards or downwards may cause damage to the internal circuitry.

■ When not in use for a long time

Caution

This TV will still consume some power even in the Off mode, as long as the mains plug is still connected to a live socket outlet.

- Remove the mains plug from the wall socket when the TV is not in use for a prolonged period of time.

■ Battery for the Remote Control / 3D Eyewear / Electronic Touch Pen / VIERA Touch Pad Controller

Caution

- Incorrect installation may cause battery leakage, corrosion and explosion.
- Replace only with the same or equivalent type.
- Do not mix old and new batteries.
- Do not mix different battery types (such as alkaline and manganese batteries).
- Do not use rechargeable batteries (Ni-Cd, etc.).
- Do not burn or break up batteries.
- Do not expose batteries to excessive heat such as sunshine, fire or the like.
- Make sure you dispose of batteries correctly.
- Remove the battery from the unit when not using for a prolonged period of time to prevent battery leakage, corrosion and explosion.

■ Electronic Touch Pen Use

Warning

- The TV may be hot. Do not touch it continuously to prevent low temperature burn.

Caution

- Do not forcibly hit or pick the TV screen with the Electronic Touch Pen to prevent the TV from falling over.
- Touch the TV screen only with the tip of the Electronic Touch Pen, do not move the tip with exerting pressure on, or do not move the tip fast to prevent the scratch of the screen.
- Stop using the Electronic Touch Pen immediately if you experience any redness, pain or skin irritation. In rare cases, the materials used in the Electronic Touch Pen may cause an allergic reaction.
- Use the Electronic Touch Pen taking a break sometimes. Guideline for continuous use is around 1 hour to protect against eyestrain or physical deconditioning.
- Do not use the Electronic Touch Pen at high temperatures. Always keep the Electronic Touch Pen in a cool and dry place.

■ 3D Eyewear Use

Caution

- Use the 3D Eyewear only for the intended purpose and nothing else.
- Do not move around while wearing the 3D Eyewear to avoid falling or accidental injury.
- Do not drop, bend, exert pressure on, or step on the 3D Eyewear.
- Be careful of the tips of the frame when putting on the 3D Eyewear.
- Be careful not to trap your fingers in the hinge section of the 3D Eyewear.
- Do not use the 3D Eyewear if it is physically damaged.
- If you suffer from any eyesight problems (short / far-sighted, astigmatism, eyesight differences in left and right), ensure that you correct your vision before using the 3D Eyewear. The supplied 3D Eyewear can be worn over vision correction glasses.
- Stop using the 3D Eyewear immediately if you experience any redness, pain or skin irritation around the nose or temples. In rare cases, the materials used in the 3D Eyewear may cause an allergic reaction.
- Do not use the 3D Eyewear at high temperatures. Always keep the 3D Eyewear in a cool and dry place.
- Stop using the 3D Eyewear immediately if a malfunction or fault occurs.

■ Viewing 3D Images

Caution

- Pay special attention when children are viewing 3D images. 3D images should not be viewed by children younger than about 6 years old, as a guideline. All children must be fully supervised by parents or guardians who must ensure their safety and health while they are viewing 3D images.
- Stop viewing 3D images immediately if you feel tired, feel unwell, experience any other uncomfortable sensation or clearly see double images. Take an appropriate break before continuing to view. When you set the 3D effect by using [3D Adjustment], take into account that the vision of 3D images varies among different individuals.
- Do not view 3D images if you have a history of oversensitivity to light, heart problems or any other medical conditions.
- When viewing 3D images, your sense of distance may be tricked or go wrong. Be careful not to hit the TV screen or other people unintentionally. Ensure there are no breakable objects around you to avoid any accidental damage or injury.
- Do not view 3D images from a distance shorter than recommended. The recommended viewing distance is at least 3 times of the image height.

55-inch model : 2.1 m or more

65-inch model : 2.4 m or more

When black bands at the top and bottom of the screen are displayed, such as movies, view the screen from a distance at least 3 times the height of the actual image. (That makes the distance shorter than the recommended values above.)

Accessories

Remote Control

➔ (p. 11)



• N2QAYB000854

VIERA Touch Pad Controller

➔ (p. 12)



• N2QBYB000028

Pedestal

➔ (p. 6)

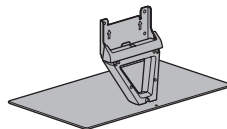

Mains lead

➔ (p. 7)

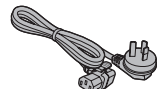

Batteries (4)

• R6

➔ (p. 11, 12)



Ferrite core for LAN cable (2)

➔ (p. 8)



Use the Ferrite cores to comply with the EMC standard.

3D Eyewear (2)

➔ (p. 18)



Electronic Touch Pen (with R03 battery)

➔ (p. 13)

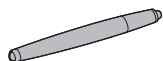

Cable tie

➔ (p. 10)



Fall-prevention parts

➔ (p. 6)

Operating Instructions
with Warranty statement

- Accessories may not be placed all together. Take care not to throw them away unintentionally.
- For the information of optional accessories, refer to [eHELP] (Support > Optional accessories).

Assembling / Removing the pedestal

A Assembly screw (8)



C Bracket

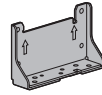

E Cover

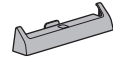

B Assembly screw



D Base

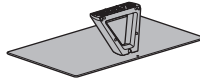

Cable clamp (4) → (p. 10)



■ Assembling the pedestal

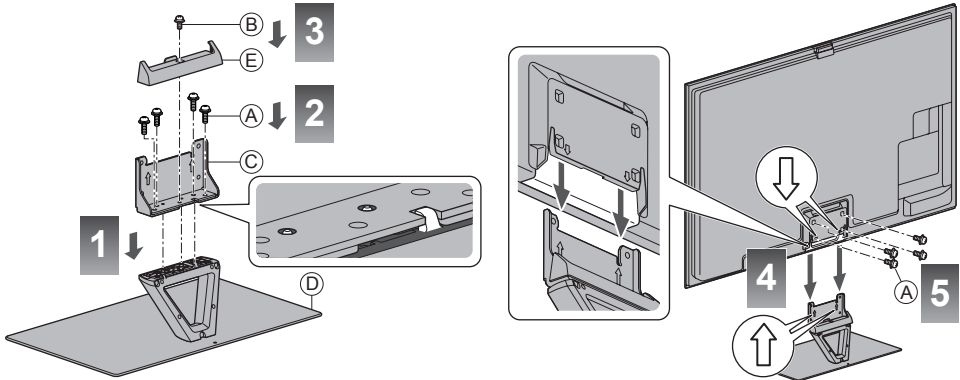

■ Preventing the TV from falling over

It is recommended to secure the pedestal to a furniture as shown to prevent the TV from falling over.

- This information is designed to reduce the risk of injuries caused by the TV falling over. However, no measure can guarantee protection in all cases.

G Band

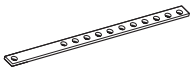

H Screw



I Wood screw

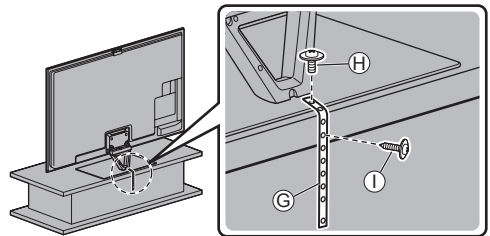

Removing the pedestal from the TV

Be sure to remove the pedestal in the following way when using the wall-hanging bracket or repacking the TV.

- 1 Remove the assembly screws (A) from the TV.
- 2 Pull out the pedestal from the TV.
- 3 Remove the assembly screw (E) from the cover.
- 4 Pull out the cover.
- 5 Remove the assembly screws (A) from the bracket.

Connections

- External equipment and cables shown are not supplied with this TV.
- Ensure that the unit is disconnected from the mains socket before attaching or disconnecting any leads.
- Check the type of terminals and cable plugs are correct when connecting.
- Always use a fully wired HDMI cable.
- Keep the TV away from electronic equipment (video equipment, etc.) or equipment with an infrared sensor. Otherwise, distortion of image / sound may occur or operation of other equipment may be interfered.
- Also read the manual of the equipment being connected.

Terminals

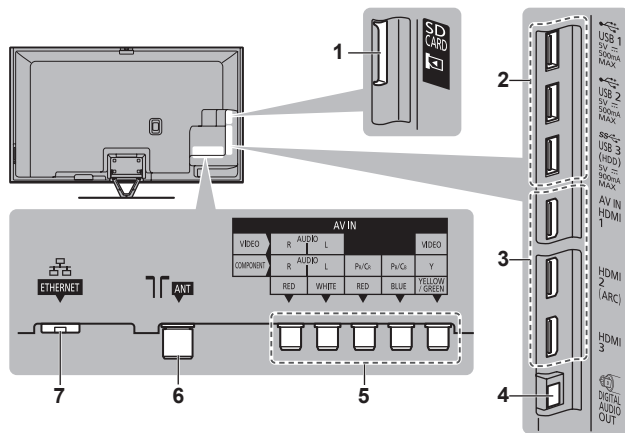

- 1 SD Card slot
- 2 USB 1 - 3 port
- 3 HDMI1 - 3 ➔ (p. 8, 9)
- 4 DIGITAL AUDIO OUT
- 5 AV (COMPONENT / VIDEO) ➔ (p. 9)
- 6 Aerial terminal ➔ (see below)
- 7 ETHERNET ➔ (p. 8)

Basic connections

Mains lead and aerial

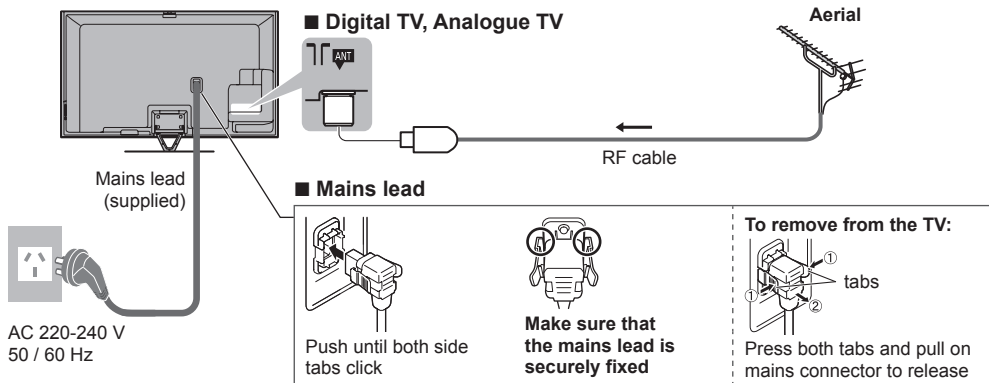

- Keep RF (aerial) cable away from the mains lead to avoid and minimise mains interference pickup.
- Do not place the RF cable under the TV.
- An aerial, correct cable (75 Ω coaxial) and correct terminating plug are required to obtain optimum quality picture and sound.
- If a communal aerial system is used, you may require the correct connection cable and plug between the wall aerial socket and the TV.
- Your local Television Service Centre or dealer may be able to assist you in obtaining the correct aerial system for your particular area and the accessories required.
- Any matters regarding aerial installation, upgrading of existing systems or accessories required, and the costs incurred, are the responsibility of you, the customer.

AV devices

■ DVD Recorder / VCR

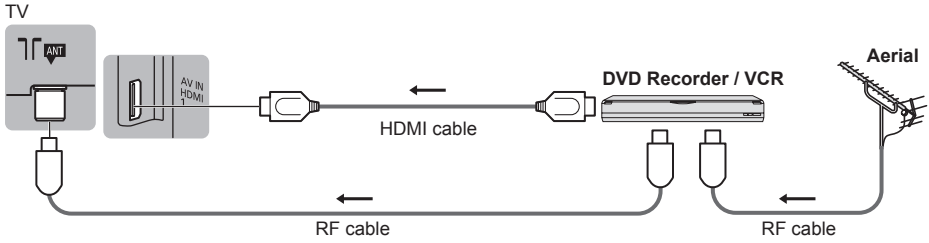

■ Set top box

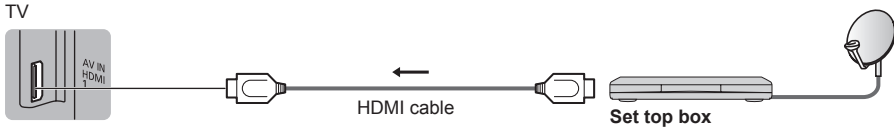

Network

- To enable the network service functions (VIERA Connect, etc.), you need to connect the TV to a broadband network environment. If you do not have any broadband network services, please consult your retailer for assistance.
- Prepare the internet environment for wired connection or wireless connection.
- Setup of the network connection will start when first using the TV. ➔(p. 15)

■ Wired connection

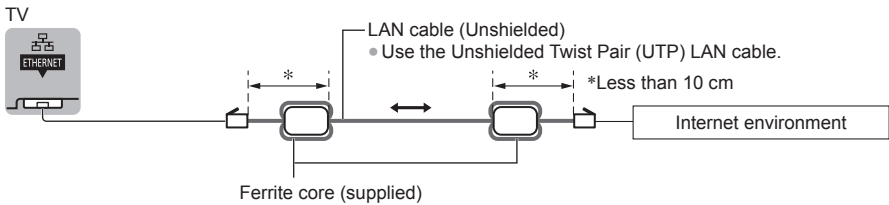

Installing the Ferrite core

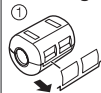

Pull back the tabs
(in two places)

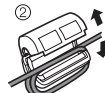

Wind the cable twice

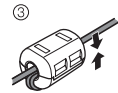

Close

■ Wireless connection

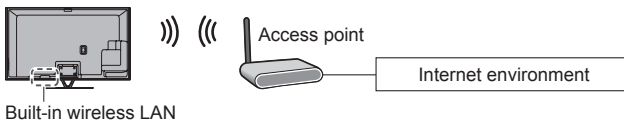

Other connections

■ DVD player (COMPONENT equipment)

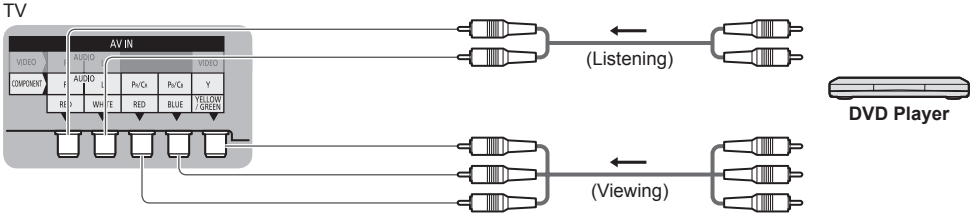

■ Camcorder / Game equipment (VIDEO equipment)

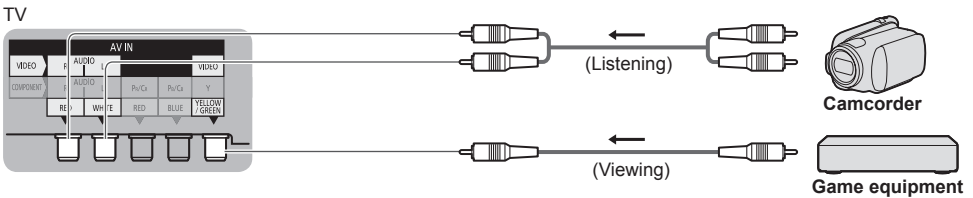

■ Amplifier (to listen with speakers)

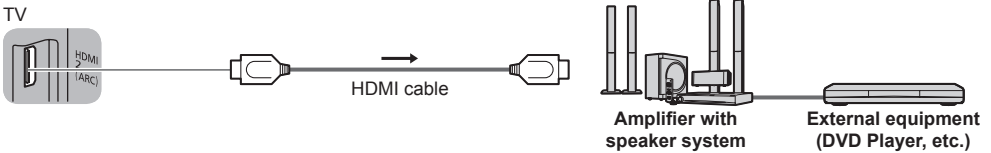

- Use HDMI2 for connecting an amplifier. This connection is applicable when using an amplifier that has ARC (Audio Return Channel) function.
As for an amplifier without ARC function, use DIGITAL AUDIO OUT.
- To enjoy the sound from the external equipment in multi-channel sound (e.g. Dolby Digital 5.1ch), connect the equipment to the amplifier. For the connections, read the manuals of the equipment and amplifier.

Types of connectable equipment to each terminal

Features	Terminal					
	AV		DIGITAL AUDIO OUT	ETHERNET	HDMI 1 - 3	USB 1 - 3
	COMPONENT	VIDEO				
To play back videocassettes / DVDs (VCR / DVD Player)	○	○			○	
To watch 3D contents (Blu-ray Disc Player)					○	
To watch satellite broadcasts (Set top box)		○			○	
To watch camcorder images (Video camera)		○			○	
To play games (Game equipment)		○			○	
To use amplifier with speaker system			○		○*1	
To use network services				○		
USB HDD Recording						○*2
VIERA Link					○	

○: Recommended Connection

*1: Use HDMI2 for connecting an amplifier. This connection is applicable when using an amplifier that has ARC (Audio Return Channel) function.

*2: Use USB 3 port for connecting the USB HDD.

Using the cable tie and cable clamp (supplied)

- Do not bundle the RF cable and mains lead together (could cause distorted image).
- Fix cables with the cable tie and cable clamp as necessary.
- When using the optional accessory, follow the option's assembly manual to fix cables.

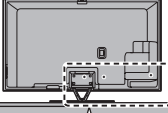

Attach the cable tie

Insert the cable tie in a hole

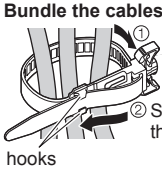

Bundle the cables

① Set the tip in the hooks
② Set the tip in the hooks

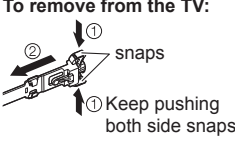

To remove from the TV:

① Keep pushing both side snaps

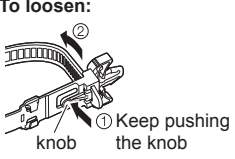

To loosen:

① Keep pushing the knob

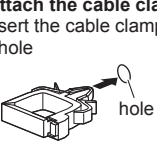

Attach the cable clamp

Insert the cable clamp in a hole

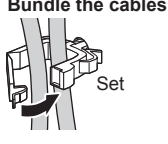

Bundle the cables

Set

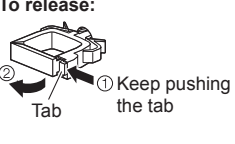

To release:

① Keep pushing the tab

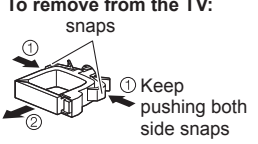

To remove from the TV:

snaps

① Keep pushing both side snaps

Identifying Controls

Remote Control

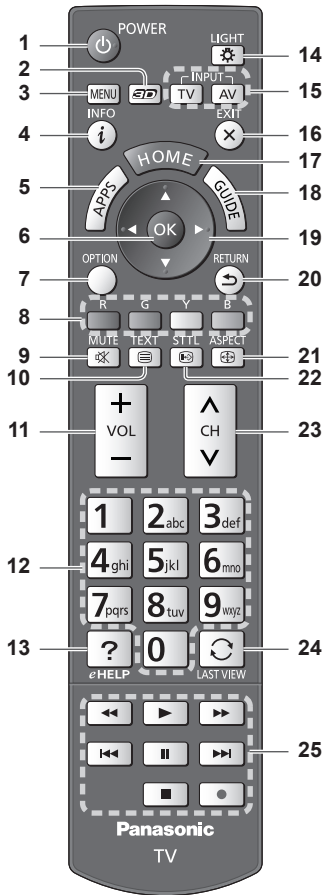

- 1 Standby On / Off switch**
- 2 3D button**
 - Switches the view between 2D and 3D.
- 3 [Main Menu]**
 - Press to access Picture, Sound, Network, Timer, Setup and Help Menus.
- 4 Information**
 - Displays channel and programme information.
- 5 APPS**
 - Displays [APPS List] (applications list).

- 6 OK**
 - Confirms selections and choices.
 - Press after selecting channel positions to quickly change channel.
 - Displays the Channel List.
- 7 [Option Menu]**
 - Easy optional setting for viewing, sound, etc.
- 8 Coloured buttons (red-green-yellow-blue)**
 - Used for the selection, navigation and operation of various functions.
- 9 Sound Mute On / Off**
- 10 Teletext button**
 - This button is not used for this model. Australia
 - Switches to teletext mode. New Zealand
- 11 Volume Up / Down**
- 12 Numeric buttons**
 - Changes channel. Australia
 - Changes channel and teletext pages. New Zealand
 - Sets characters.
 - When in Standby mode, switches TV on.
- 13 [eHELP]**
 - Displays [eHELP] (Built-in Operating Instructions).
- 14 Light**
 - Lights the buttons for about 5 seconds (except the buttons "25").
- 15 Input mode selection**
 - TV - switches to Digital TV / Analogue TV.
 - AV - switches to AV input mode from Input Selection list.
- 16 Exit**
 - Returns to [Home Screen].
- 17 HOME**
 - Displays [Home Screen].
- 18 TV Guide Australia
Freeview Guide New Zealand**
- 19 Cursor buttons**
 - Makes selections and adjustments.
- 20 Return**
 - Returns to the previous menu / page.
- 21 Aspect**
 - Changes aspect ratio.
- 22 Subtitles**
 - Displays subtitles.
- 23 Channel Up / Down**
- 24 Last view**
 - Switches to previously viewed channel or input mode.
- 25 Operations for contents, connected equipment, etc.**

■ Installing / Removing batteries

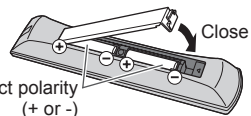
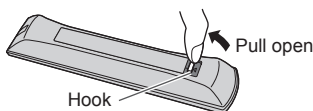

Note the correct polarity (+ or -)

VIERA Touch Pad Controller

This touch pad controller is designed for the convenient operations, especially, on Home Screen or internet contents. You can operate the TV intuitively with this controller.

- The touch pad controller can be used by registering to this TV with Bluetooth wireless technology. Setup screen to register will appear in "First time Auto Tuning" for first using the TV. ➔ (p. 15)
- After registering, you can operate the TV without pointing this controller at the TV (except Standby On / Off switch).
- To use Standby On / Off switch, point the controller directly at the TV's remote control signal receiver because it works with the infrared. (You can operate the switch without registration.)
- It is recommended to speak within about 15 cm from microphone of VIERA Touch Pad Controller when using Voice Control function.

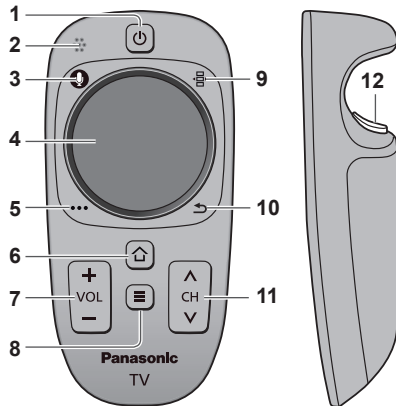

1 Standby On / Off switch

- Same function of the remote control button 1 (p. 11).

2 Microphone

3 Microphone button

4 Touch pad (see below)

5 [Option Menu]

6 HOME

- Same function of the remote control button 17 (p. 11).

7 Volume Up / Down

- Same function of the remote control button 11 (p. 11).

8 APPS

- Same function of the remote control button 5 (p. 11).

9 On-screen remote control

- Press to display the remote control GUI (Graphical User Interface). Press again to move the position of GUI. (To change the page of GUI, slide your finger to the left / right on the touch pad.)

10 Return

- Same function of the remote control button 20 (p. 11).

11 Channel Up / Down

- Same function of the remote control button 23 (p. 11).

12 OK

■ Touch Pad



- Tap the centre of the pad for "OK".



- Slide your finger to move the cursor (on internet contents or [Cursor Settings] in [VIERA Touch Pad Controller] (Setup Menu)), select the item, adjust levels, etc.



- Trace the fringe to scroll.

■ Installing / Removing batteries

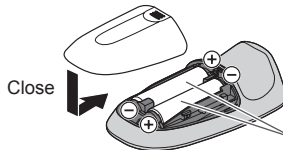
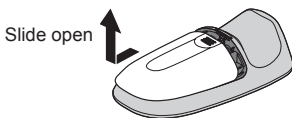

Note the correct polarity (+ or -)

Note

- It is recommended to hold the touch pad controller with your hand when using.
- The battery power will be used whenever you use the touch pad controller (including the touch of the touch pad) even if not operating the TV. It may decrease the battery life.
- Some operations differ depending on the application.

Electronic Touch Pen

You can paint or play games on the TV screen with the Electronic Touch Pen.

- The Electronic Touch Pen can be used by pairing to the TV in [Auto Tuning] (p. 15) or [Touch Pen Setup]. For more information, refer to [eHELP] (Functions > Electronic Touch Pen > Touch Pen Setup).

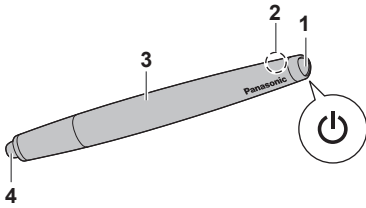

1 Power button

To turn on: Press once

To turn off: Press and hold 2 seconds or longer

- Automatically turned off if unused for 5 minutes.

2 Indicator lamp

- Lights for approx. 2 seconds when turned on, and then blinks at approx. 2-second intervals.
- Up to 2 pieces of the Electronic Touch Pen (Pen1 / Pen2) can be used simultaneously. Indicator blinks:
 - Pen1: Red
 - Pen2: Green
- Also lights or blinks when pairing the Electronic Touch Pen to the TV.
- Blinks 5 times consecutively at power-on when the battery level is low.

3 Unit cover

4 Pen tip

Press the pen tip on this side of the Electronic Touch Pen against the TV screen for use.

■ Inserting the battery

- 1 Turn and slide the unit cover until the entire shape of the battery is visible.

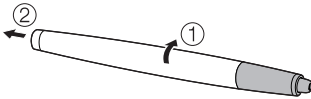

- 2 Insert the R03 battery, and then slide and turn the unit cover to close until it clicks.

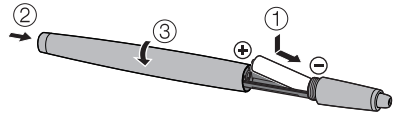

■ How to hold the Electronic Touch Pen

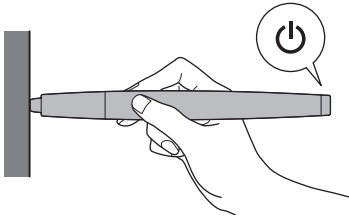

- Touch the tip of the Electronic Touch Pen vertically onto the TV screen and press it lightly.

Note

- Do not use devices such as mobile phones or personal transceivers that emit strong electromagnetic waves near the Electronic Touch Pen as this may cause the Electronic Touch Pen to malfunction.
- Use the Electronic Touch Pen where there is no interference from other Bluetooth devices.
- For more information, refer to [eHELP] (Functions > Electronic Touch Pen).

Indicator / Control panel

- When pressing 1, 2, 3 buttons, the control panel guide appears on the side of the screen for 3 seconds to highlight the pressed button.

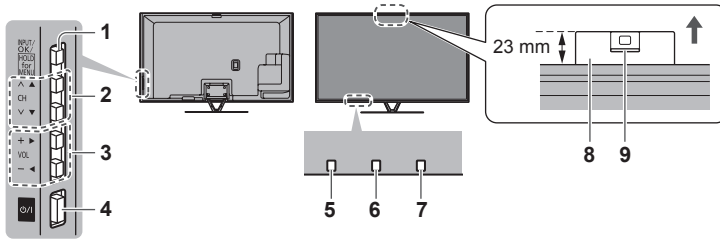

Rear side of the TV

1 Input mode selection

- Press repeatedly until you reach the desired mode.

[Main Menu]

- Press and hold for about 3 seconds to display main menu.

OK (when in the menu system)

2 Channel Up / Down

Cursor Up / Down (when in the menu system)

3 Volume Up / Down

Cursor Left / Right (when in the menu system)

4 Mains power On / Off switch

- Use to switch the mains power.

5 Remote control signal receiver

- Do not place any objects between the TV remote control signal receiver and remote control.

6 Ambient sensor

- Senses brightness to adjust picture quality when [Ambient Sensor] in the Picture Menu is set to [On].

7 Power LED

Red: Standby

Green: On

Orange: Standby with Timer Programming On

[Australia]

Standby with Recording

- The LED blinks when the TV receives a command from the remote control.

8 Built-in Camera

- Automatically pops up when the camera operation is activated.

Close manually by pushing top of the camera.

- For the information of the camera operation, refer to [eHELP] (Functions > Built-in Camera).

9 Lens part

- Tilt: -17° to +17°

Using the On Screen Displays - Operation guide

Many features available on this TV can be accessed via the On Screen Display menu.

■ Operation guide

Operation guide will help your operation by using the remote control.

Example: [Sound Menu]

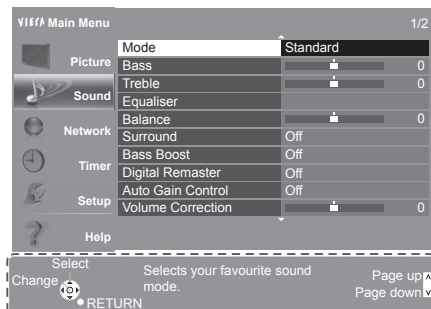

Operation guide

■ How to use remote control



Open the main menu



Move the cursor / select from a range of options / select the menu item (up and down only) / adjust levels (left and right only)



Access the menu / store settings after adjustments have been made or options have been set

RETURN



Return to the previous menu



Exit the menu system and return to [Home Screen]

First time Auto Tuning

Automatically sets up the TV and searches for available TV channels when the TV is turned on for the first time.

- These steps are not necessary if the setup has been completed by your local dealer.
- Please complete connections (p. 7 - 10) and settings (if necessary) of the connected equipment before starting Auto Tuning. For details of settings for the connected equipment, read the manual of the equipment.

1 Plug the TV into mains socket and turn power on



POWER • Takes a few seconds to be displayed.

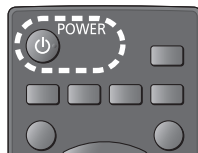

2 Select the following items

Set up each item by following the on-screen instructions.

Select [Home]

Select [Home] viewing environment to use in your home environment.

- [Shop] is for shop display.
- To change viewing environment later on, you will need to initialise all settings by accessing Shipping Condition.

Set up the network connection

Select your area (Australia)

Tick the TV signal mode to tune, and then select [Start Auto Tuning]

- : tune (search for the available channels)
- : skip tuning

Register the VIERA Touch Pad Controller to this TV

Select [Pairing] and follow the on-screen instructions to use the touch pad controller (supplied).

Register the Electronic Touch Pen to this TV

Select [Pairing] and follow the on-screen instructions to use the Electronic Touch Pen (supplied).

3 Select the type of [Home Screen]

The demonstration to explain how to use [my Home Screen] is displayed. Confirm the demonstration by following the on-screen instructions, and then select the desired [Home Screen].

Example: [Home Screen Selection]



Example: [TV Home Screen]



- [my Home Screen] is the start-up screen when the TV is turned on or the HOME button is pressed.

Auto Tuning is now complete and your TV is ready for viewing.

If tuning has failed, check the connection of the network, RF cable, and then follow the on-screen instructions.

Note

- The TV will automatically go into Standby mode when no operation is performed for 4 hours if [Auto Standby] in the Timer Menu is set to [On].
- The TV will automatically go into Standby mode when no signal is received and no operation is performed for 10 minutes if [No signal Power off] in the Timer Menu is set to [On].
- To retune all channels ➔ **[Auto Tuning]** in **[Tuning Menu]** (**Setup Menu**)
- To add the available TV signal mode later ➔ **[Add TV Signal]** in **[Tuning Menu]** (**Setup Menu**)
- To initialise all settings ➔ **[Shipping Condition]** in **[System Menu]** (**Setup Menu**)

Operations

Turn power on

⏻/I (TV) or  POWER (Remote Control)

The last viewed [Home Screen] is displayed.

Example: [TV Home Screen]



- Mains power On / Off switch should be on. (p. 14)

Example: Selected content screen



- To return to [Home Screen] at any time



- You can set up or make [Home Screen] to display desired information, to access specific features easily, to select the default [Home Screen], etc. For details, follow the on-screen instructions or refer to [eHELP] (Watching > my Home Screen).

Watching TV

1 Select the TV viewer from [Home Screen]



2 Select Digital TV or Analogue TV



3 Select a channel

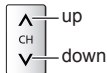

- To select 2 or more-digit channel position number, e.g. 399

To access each feature

Access [APPS List] and select a feature

Example: [APPS List]



- APPS is the applications (features) of the TV.
- For operations of each feature and the setup of [APPS List], follow the on-screen instructions or refer to [eHELP] (Functions > APPS List).

How to Use eHELP

[eHELP] is the detailed operating instructions built into the TV, and helps you to get more understanding of the operations for each feature.

1 Display [eHELP]

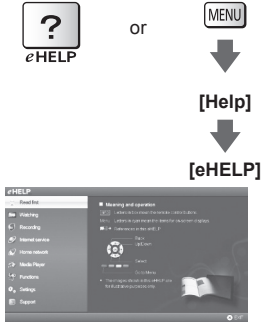

- [Read first] will be displayed on the top page. Please read these instructions fully to get more understanding of the operation in [eHELP].
- If this is not the first time to view [eHELP] from when the TV is turned on, the confirmation screen is displayed to select whether [First Page] or [Last Page].

2 Select the category and item

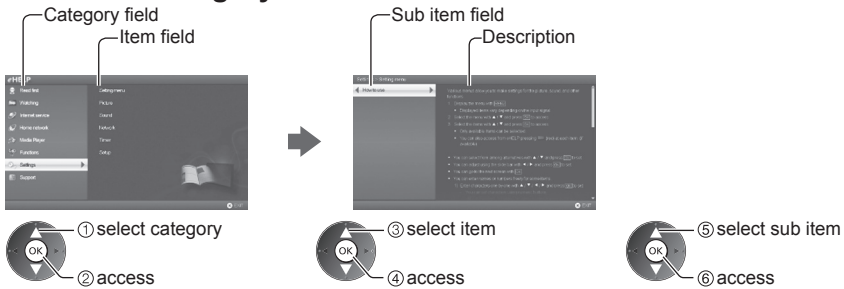

- To return to the previous field



- To scroll the description (if more than 1 page)
While the description is highlighted



- To display the menu related to the description (only for some descriptions)



Viewing 3D images

You can enjoy viewing 3D images with contents or programmes corresponding to the 3D effect by wearing the 3D Eyewear. ➔ **“Accessories” (p. 5)**

- The 3D Eyewear must be worn to view 3D images.
- This TV supports [Frame Sequential]*, [Side by Side] and [Top and Bottom] 3D formats.

*: The 3D format that the images for the left and right eyes are recorded with the high definition quality and alternately played back.

3D Eyewear

Use the supplied 3D Eyewear or Panasonic 3D Eyewear that has this logo and supports Bluetooth® wireless technology.



- “Full HD 3D Glasses™” logo indicates products that are compatible with the active shutter 3D glasses technology standards licensed by the Full HD 3D Glasses Initiative. The RF mark on the logo means the wireless system (Bluetooth® wireless technology), and you can use the 3D Eyewear and the TV that have the same mark together.

Note

- Do not exert pressure on or scratch the lens of the 3D Eyewear.
- Do not use devices such as mobile phones or personal transceivers that emit strong electromagnetic waves near the 3D Eyewear as this may cause the 3D Eyewear to malfunction.
- Do not wear the 3D Eyewear when watching anything other than 3D images. Liquid crystal displays (such as computer screens, digital clocks or calculators, etc.) may be difficult to see while wearing the 3D Eyewear.

First registration

Perform the first registration when first using the 3D Eyewear with this TV.

1 Turn the TV on

2 Press Power button for about 1 second to turn the 3D Eyewear on

- The lamp lights for about 2 seconds and then flashes.
- The 3D Eyewear will be turned on and start registration.
- Place the 3D Eyewear within 50 cm from the TV while registration in progress.

3 After the registration is successfully completed, the 3D Eyewear will reconnect with TV automatically when the 3D Eyewear is turned on near the TV in 3D mode

Registration again

When connection with the registered TV fails, or when using with another TV, re-register the 3D Eyewear.

1 Turn the TV on

2 Within 50 cm from the TV, press Power button until lamp lights, then release it to start registration

3 After the registration is successfully completed, the 3D Eyewear will reconnect with TV automatically when the 3D Eyewear is turned on near the TV in 3D mode

To view the 3D images

■ Playing back 3D-compatible Blu-ray disc (Frame Sequential format)

- Connect the 3D-compatible player via a fully wired HDMI compliant cable. (If you use the non 3D-compatible player, the images will be displayed in 2D mode.)
- If the input mode is not switched automatically, select the input mode connected to the player using the AV button.

■ 3D-supported broadcast

- Please consult the suppliers of contents or programmes for availability of this service.

■ 3D photos and 3D videos taken by 3D-compatible Panasonic products

- Available in Media Player and Network services.

■ 2D images converted to 3D

- Press the 3D button and set to [2D→3D] mode in [3D Mode Selection].

Preparations

Ensure that the registration of the 3D Eyewear has been completed.

1 Turn the 3D Eyewear on and put it on

Connection status and battery status are displayed on the bottom right of the screen.

2 View the 3D images

Safety precautions will be displayed when you first watch the 3D image. Select [Yes] or [No] to continue to view 3D images.

Note

- Turn off the 3D Eyewear after using it.
- Use the 3D Eyewear within approximately 3.2 m from the TV. You cannot view the 3D images with the 3D Eyewear too far from the TV, because of the difficulty of receiving radio waves from the TV.
- The range may be shortened depending on the obstacles between the TV and the 3D Eyewear, or the surrounding environment.
- Use the 3D Eyewear where there is no interference from other Bluetooth devices.
- 3D content will not be correctly visible if the 3D Eyewear is worn upside down or back-to-front.
- When viewing 3D images, make sure your eyes are at an approximately horizontal level and keep a position where you do not see double images.
- If light appears to flicker under fluorescents or dimmers when using the 3D Eyewear, change the setting of [3D Refresh Rate] in [3D Settings] (Picture Menu).
- There are differences in the viewing range of the 3D Eyewear among individuals.

FAQs

Before requesting service or assistance, please follow these simple guides to solve the problem.

- For more information, refer to [eHELP] (Support > FAQs).

The TV does not switch on

- Check the mains lead is plugged into the TV and the socket outlet.

The TV goes into Standby mode

- Auto power standby function is activated.

The remote control does not work or is intermittent

- Are the batteries installed correctly? ➔ (p. 11)
- Has the TV been switched on?
- The batteries may be running low. Replace them with new ones.
- Point the remote control directly at the TV's remote control signal receiver (within about 7 m and a 30 degree angle of the signal receiver).
- Situate the TV away from sunshine or other sources of bright light not to shine on the TV's remote control signal receiver.

Electronic Touch Pen does not work

- Check that the batteries are fresh, are of the same type and are installed with the correct polarity (+ & -).
- Check if the pairing range is within 50 cm.
- The Electronic Touch Pen automatically turns off if pairing cannot be performed within 2 minutes. In this case, pair again.
- The Electronic Touch Pen automatically turns off if unused for 5 minutes.
(When the Electronic Touch Pen is turned on, the indicator lamp blinks but turns off in several minutes.) Turn the power on again.

No image can be displayed

- Check the TV is turned on.
- Check the mains lead is plugged into the TV and the socket outlet.
- Check the correct input mode is selected.
- Check the setting of [AV] ([COMPONENT] / [VIDEO]) in [Input Selection] to match the output of the external equipment.
- Is [Contrast], [Brightness] or [Colour] in the Picture Menu set to the minimum?
- Check all required cables and connections are firmly in place.

Unusual image is displayed

- Turn the TV off with Mains power On / Off switch, then turn it on again.
- If the problem persists, initialise all settings. ➔ [Shipping Condition] in [System Menu] (Setup Menu)
- Image retention images may be reduced / removed by [Scrolling Bar] in [Screen Settings] (Picture Menu).

Unusual sound from the TV

- When the power is on, whirring sound of cooling fan or drive noise may be heard from inside the TV (not a sign of faulty operation).

Parts of the TV become hot

- Even if the temperature of parts of the front, top and rear panels has risen, these temperature rises do not cause any problems in terms of performance or quality.

Maintenance

First, remove the mains plug from the socket outlet.

Display panel, Cabinet, Pedestal

Regular care:

Gently wipe the surface of the display panel, cabinet, or pedestal by using a soft cloth to clean the dirt or fingerprints.

For stubborn dirt:

First clean the dust on the surface. Dampen a soft cloth with clean water or diluted neutral detergent (1 part detergent to 100 parts water). Wring the cloth and wipe the surface. Finally, wipe away all the moisture.

Caution

- Do not use a hard cloth or rub the surface too hard, otherwise this may cause scratches on the surface.
- Take care not to subject the TV's surfaces to water or detergent. Liquid inside the TV could lead to product failure.
- Take care not to subject the surfaces to insect repellent, solvent, thinner or other volatile substances. This may degrade surface quality or cause peeling of the paint.
- The surface of the display panel is specially treated and may be easily damaged. Take care not to tap or scratch the surface with your fingernail or other hard objects.
- Do not allow the cabinet and pedestal to make contact with a rubber or PVC substance for a long time. This may degrade surface quality.

Mains plug

Wipe the mains plug with a dry cloth at regular intervals. Moisture and dust may cause fire or electrical shock.

Specifications

■ TV

		55-inch model	65-inch model
Model No.		TH-P55VT60A TH-P55VT60Z	TH-P65VT60A TH-P65VT60Z
Power	Rating	AC 220-240 V, 50 / 60 Hz 2.4A	AC 220-240 V, 50 / 60 Hz 2.6A
	Normal (Home) mode	184 W	222 W
	Standby power consumption	0.3 W	0.3 W
Visible screen size (diagonal)		140 cm	165 cm
Dimensions (W × H*1 × D)		1,318 mm × 855 mm × 296 mm (With Pedestal) 1,318 mm × 767 mm × 51 mm (TV only)	1,531 mm × 975 mm × 323 mm (With Pedestal) 1,531 mm × 887 mm × 51 mm (TV only)
Mass		38.5 kg Net (With Pedestal) 31.5 kg Net (TV only)	50.5 kg Net (With Pedestal) 42.0 kg Net (TV only)

		Australia	New Zealand
Model No.		TH-P55VT60A TH-P65VT60A	TH-P55VT60Z TH-P65VT60Z
Receiving systems / Band name	Digital TV	7 MHz VHF / UHF (Australia) free-to-air TV broadcast reception	8 MHz UHF (New Zealand) free-to-air TV broadcast reception
	PAL B / G	Reception of Off air broadcasts	
	PAL 60 Hz	Playback of NTSC tape from some PAL Video recorders (VCR)	
	M.NTSC	Playback from M.NTSC Video recorders (VCR)	
	NTSC	Playback from NTSC Video recorders (VCR)	
Aerial input		Standard Belling & Lee connector VHF / UHF	
Display resolution		1,920 (W) × 1,080 (H)	
Panel		Plasma Display	
Connection terminals	AV IN (COMPONENT / VIDEO)	VIDEO	RCA PIN Type × 1 1.0 V[p-p] (75 Ω)
		AUDIO L - R	RCA PIN Type × 2 0.5 V[rms]
		Y	1.0 V[p-p] (including synchronisation)
		Pb/Cb, Pr/Cr	±0.35 V[p-p]
	HDMI 1 / 2 / 3 input	TYPE A Connectors HDMI1 / 3: 3D, Content Type, Deep Colour, x.v.Colour™ HDMI 2: 3D, Content Type, Audio Return Channel, Deep Colour, x.v.Colour™ • This TV supports "HDAVI Control 5" function.	
	Card slot	SD Card slot × 1	
	ETHERNET	10BASE-T / 100BASE-TX	
	USB 1 / 2 / 3	USB1 / 2: USB2.0 DC 5 V, Max. 500 mA USB3: USB3.0 DC 5 V, Max. 900 mA	
DIGITAL AUDIO OUT	PCM / Dolby Digital / DTS, Fibre optic		
Sound	Speaker	Front speaker × 2, Woofer (Φ 75 mm) × 1	
	Audio output	20 W (5 W + 5 W + 10 W)	
Operating conditions		Temperature: 0 °C - 35 °C Humidity: 20 % - 80 % RH (non-condensing)	
Built-in Camera		Lens: F2.0 Lens; FOV (D) 50.9° (in HD mode) Focus: Fixed focus Resolution: 1,280 × 720	
Built-in wireless LAN		Standard compliance and Frequency range*2: IEEE802.11a/n 5.15 GHz - 5.35 GHz, 5.47 GHz - 5.85 GHz IEEE802.11b/g/n 2.40 GHz - 2.4835 GHz	
		Security: WPA2-PSK (TKIP/AES) WPA-PSK (TKIP/AES) WEP (64 bit/128 bit)	
Bluetooth wireless technology*3		Standard Compliance: Bluetooth 3.0	
		Frequency Range: 2.402 GHz - 2.480 GHz	

*1: With Camera pop-up: +23 mm height

*2: The frequency and channel differ depending on the country.

*3: Not all the Bluetooth compatible devices are available with this TV. Up to 5 devices can be used simultaneously (except the 3D Eyewear and VIERA Touch Pad Controller).

■ 3D Eyewear

Dimensions (W × H × D)	164.7 mm × 41.0 mm × 170.7 mm
Mass	Approx. 34 g
Lens type	Liquid Crystal Shutter
Usage temperature range	0 °C - 40 °C
Battery	Coin-shaped lithium battery CR2025 Operation time: Approx. 75 hours in continuous use of the battery made by Panasonic
Materials	Main body: Resin Lens section: Liquid crystal glass

■ Electronic Touch Pen

Dimensions	Length: 186.7 mm Diameter: 18.2 mm
Mass	Approx. 30 g (excluding battery)
Usage temperature range	0 °C - 40 °C
Battery	Panasonic R03 battery Operation time : approx. 8 hours Panasonic LR03 battery Operation time: approx. 30 hours
Materials	Main body: Resin

Note

- 3D Eyewear, Electronic Touch Pen and VIERA Touch Pad Controller use Bluetooth wireless technology.
- Design and Specifications are subject to change without notice. Mass and Dimensions shown are approximate.
- For the information of the open source software, refer to [eHELP] (Support > Licence).

■ When using the wall-hanging bracket

- For the recommended wall-hanging bracket, refer to [eHELP].

55-inch model

- a: 500 mm
- b: 300 mm

65-inch model

- a: 684 mm
- b: 300 mm

- Holes for wall-hanging bracket installation

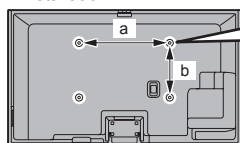

Rear of the TV

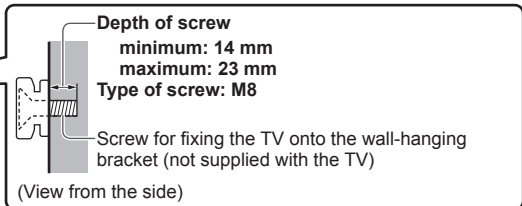

- For the information of the trademarks, refer to [eHELP] (Support > Licence).

Panasonic Warranty

1. The product is warranted for 12 months from the date of purchase. Subject to the conditions of this warranty Panasonic or its Authorised Service Centre will perform necessary service on the product without charge for parts or labour, if in the opinion of Panasonic, the product is found to be faulty within the warranty period.
2. This warranty only applies to Panasonic products purchased in Australia and sold by Panasonic Australia or its Authorised Distributors or Dealers and only where the products are used and serviced within Australia or its territories. Warranty cover only applies to service carried out by a Panasonic Authorised Service Centre and only if valid proof of purchase is presented when warranty service is requested.
3. This warranty only applies if the product has been installed and used in accordance with the manufacturer's recommendations (as noted in the operating instructions) under normal use and reasonable care (in the opinion of Panasonic). The warranty covers normal domestic use only and does not cover damage, malfunction or failure resulting from use of incorrect voltages, incorrect installation, accident, misuse, neglect, build-up of dirt or dust, abuse, maladjustment of customer controls, mains supply problems, thunderstorm activity, infestation by insects or vermin, tampering or repair by unauthorised persons (including unauthorised alterations), introduction of sand, humidity or liquids, commercial use such as hotel, office, restaurant, or other business or rental use of the product, exposure to abnormally corrosive conditions or any foreign object or matter having entered the product.
4. This warranty does not cover the following items unless the fault or defect existed at the time of purchase:

(a) Cabinet Part(s)	(e) DVD, Blu-ray, or Recordable Discs
(b) Video or Audio Tapes	(f) Video / Audio Heads from wear and tear in normal use
(c) SD cards or USB devices	(g) Information stored on Hard Disk Drive, USB stick or SD card
(d) User replaceable Batteries	(h) DTV reception issues caused by TV Aerial / Cabling / Wall socket(s)

 etc
5. Some products may be supplied with Ethernet connection hardware. The warranty is limited on such products and will not cover
 - (a) Internet and or DLNA connection / setup related problems
 - (b) Access fees and or charges incurred for internet connection
 - (c) The use of incompatible software or software not specifically stipulated in the product operations manual; and
 - (d) Any indirect or consequential costs associated with the incorrect use or misuse of the hardware, its connection to the internet or any other device.
6. To claim warranty service, when required, you should:
 - Telephone Panasonic's Customer Care Centre on 132600 or visit our website referred to below and use the Service Centre Locator for the name/address of the nearest Authorised Service Centre.
 - Send or take the product to a Panasonic Authorised Service Centre together with your proof of purchase receipt as a proof of purchase date. Please note that freight and insurance to and / or from your nearest Authorised Service Centre must be arranged by you.
 - Note that home or pick-up/delivery service is available for the following products in the major metropolitan areas of Australia or the normal operating areas of the nearest Authorised Service Centres:
 - Plasma/LCD televisions / displays (screen size greater than 103 cm)
7. The warranties hereby conferred do not extend to, and exclude, any costs associated with the installation, de-installation or re-installation of a product, including costs related to the mounting, de-mounting or remounting of any screen, (and any other ancillary activities), delivery, handling, freighting, transportation or insurance of the product or any part thereof or replacement of and do not extend to, and exclude, any damage or loss occurring by reason of, during, associated with, or related to such installation, de-installation, re-installation or transit.

Panasonic Authorised Service Centres are located in major metropolitan areas and most regional centres of Australia, however, coverage will vary dependant on product. For advice on exact Authorised Service Centre locations for your product, please telephone our Customer Care Centre on 132600 or visit our website and use the Service Centre Locator.

In addition to your rights under this warranty, Panasonic products come with consumer guarantees that cannot be excluded under the Australian Consumer Law. If there is a major failure with the product, you can reject the product and elect to have a refund or to have the product replaced or if you wish you may elect to keep the goods and be compensated for the drop in value of the goods. You are also entitled to have the product repaired or replaced if the product fails to be of acceptable quality and the failure does not amount to a major failure.

If there is a major failure in regard to the product which cannot be remedied then you must notify us within a reasonable period by contacting the Panasonic Customer Care Centre. If the failure in the product is not a major failure then Panasonic may choose to repair or replace the product and will do so in a reasonable period of time from receiving notice from you.

THIS WARRANTY CARD AND THE PURCHASE DOCKET (OR SIMILAR PROOF OF PURCHASE) SHOULD BE RETAINED BY THE CUSTOMER AT ALL TIMES

If you require assistance regarding warranty conditions or any other enquiries, please visit the **Panasonic Australia** website **www.panasonic.com.au** or contact by phone on **132 600**
If phoning in, please ensure you have your operating instructions available.

Panasonic Australia Pty. Limited

ACN 001 592 187 ABN 83 001 592 117

1 Innovation Road, Macquarie Park NSW 2113

PRO-031-F11 Issue: 4.0

01-01-2011

WARRANTY - New Zealand only

WE WARRANT that the Panasonic Television that you have purchased is free from defects in material and workmanship under normal home use and service.

Accordingly, we undertake to repair, or at our option, replace without cost to the owner, either for material or labour, any part which within 12 months from the date of delivery is found to be defective, provided that the appliance has been used for domestic purposes only and in accordance with the instructions given in the Instruction Book and not been subjected to misuse, neglect or installed, dismantled, repaired or serviced by any other than an authorised Panasonic New Zealand Dealer or Panasonic New Zealand Authorised Service Centre.

NOTE

- Before reporting a fault, please ensure that you read the item "Troubleshooting" in the information section of your Panasonic Instruction Book.
- It is important to retain your proof of purchase as this will be required by the serviceman or retailer as proof of purchase date, should service be required.
- In the event of service being required, contact your Panasonic New Zealand retailer or Panasonic New Zealand Authorised Service Centre.

IMPORTANT

Any request for warranty service must be through an Authorised Panasonic New Zealand Service Centre who during the period of the warranty, undertakes to make any necessary adjustment and fit any replacement part supplied by the manufacturer, during normal working hours, or alternatively will arrange for such service to be provided by some other Panasonic New Zealand Authorised Service Centre.

NEW ZEALAND

Distributed in New Zealand by Panasonic New Zealand Limited
 350 Te Irirangi Drive East Tamaki, Private Bag 14911, Panmure Auckland
Tel. 09 272 0100
 Customer Care Center
 Email: Customerservice@nz.panasonic.com
www.panasonic.co.nz

Information on Disposal in other Countries outside the European Union



This symbol is only valid in the European Union. If you wish to discard this product, please contact your local authorities or dealer and ask for the correct method of disposal.

Customer's Record

The model number and serial number of this product may be found on its rear panel. You should note this serial number in the space provided below and retain this book, plus your purchase receipt, as a permanent record of your purchase to aid in identification in the event of theft or loss, and for Warranty Service purposes.

Model Number

Serial Number

Panasonic Corporation

Web Site: <http://panasonic.net>

M0313-1043