

大風量 / 詳細規格

FY-800ZDY3W

設計・施工用圖 單位：mm(毫米) *請於主機側方預留檢修口(檢修口尺寸：450x450)

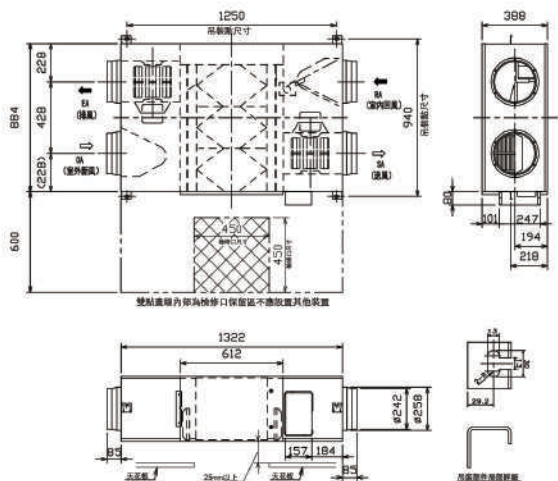

靜壓風量特性曲線圖

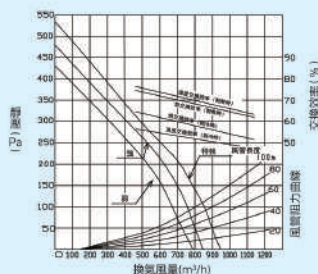

接線配置圖*1 FY-800ZDY3W(220V)控制器另購

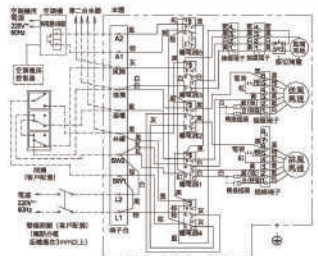

FY-01KZDY3W

設計・施工用圖 單位：mm(毫米) *請於主機側方預留檢修口(檢修口尺寸：450x450)

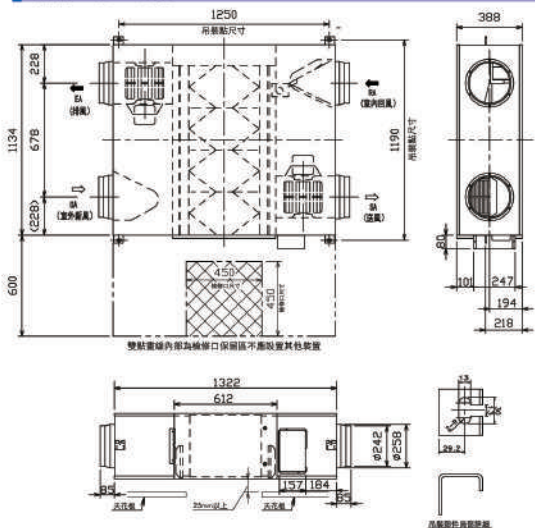

靜壓風量特性曲線圖

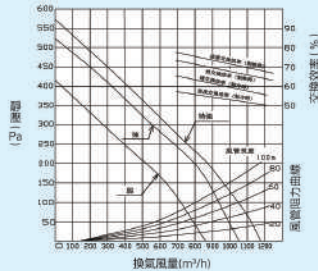

接線配置圖*1 FY-01KZDY3W(220V)控制器另購

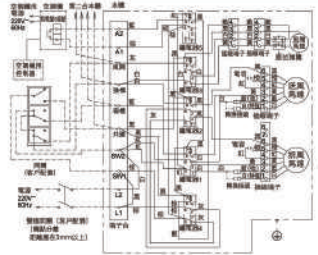

Panasonic 原廠專用部材

室內專用部材 (單位：mm)

FY-SW15ZY1W (ZY型專用)

液晶顯示控制器

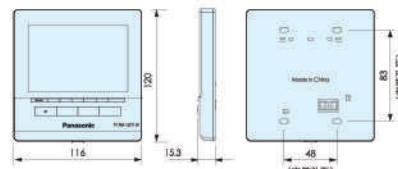

接線配置圖

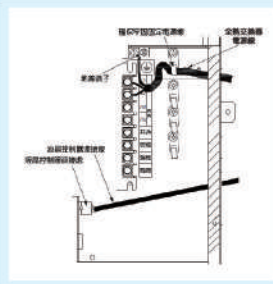

- 適用於PM2.5系列ZY型全熱交換器 ●液晶顯示面板，操作容易
- 嵌入式設計，安裝更簡便

FY-EB90SRSW (DZ、PM型專用)

液晶顯示控制器

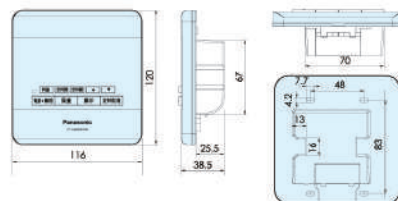

接線配置圖

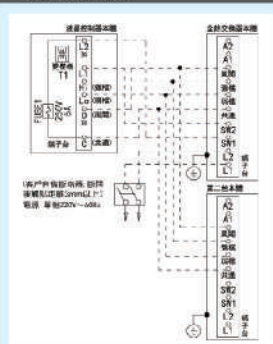

- 僅適用全熱交換器清淨型DZ型、PM型、大風量型
- 液晶顯示面板，操作容易 ●嵌入式設計，安裝更簡便
- 兩台全熱交換器可共用一只液晶顯示控制器
- 雙換氣模式(全熱換氣/普通換氣)

FY-RS15ZDP1W (ZY型專用)

全熱交換器控制器(RS485)



- 需與FY-SW15ZY1W一起搭配

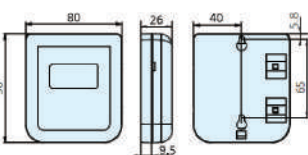

接線配置圖

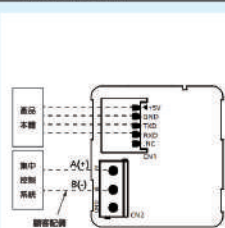

CZ-T003 (DZ、PM型專用)

全熱交換器控制器(RS485)



Panasonic 原廠專用部材

室內專用部材 (單位: mm)

FV-GD075TW 適用管道直徑: $\varnothing 75$
FV-GD100TW 適用管道直徑: $\varnothing 100$

排氣風口 內藏可調式風門設計

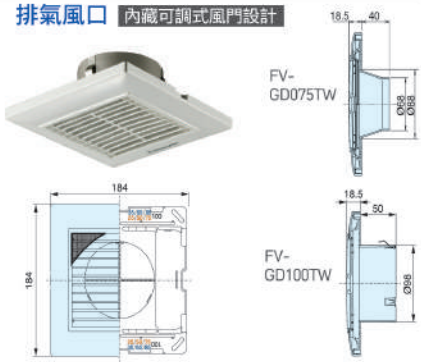

FV-GB075TW 適用管道直徑: $\varnothing 75$
FV-GB100TW 適用管道直徑: $\varnothing 100$

排氣風口 內藏可調式風門設計

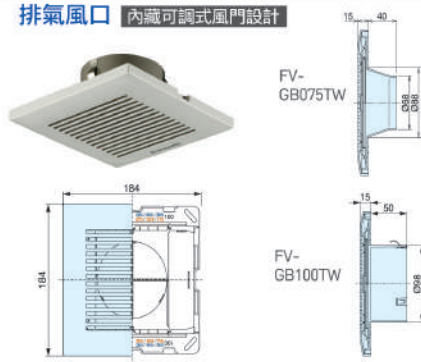

FV-GPP100TW

適用管道直徑: $\varnothing 100$

方形進氣口

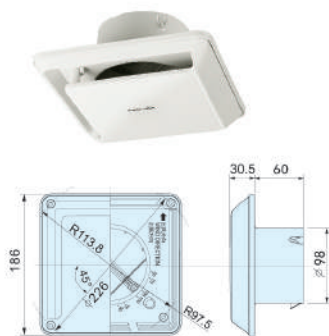

FV-GPV075TW / FV-GPF075TW
FV-GPV100TW / FV-GPF100TW

圓形風口 內藏可調式風門設計

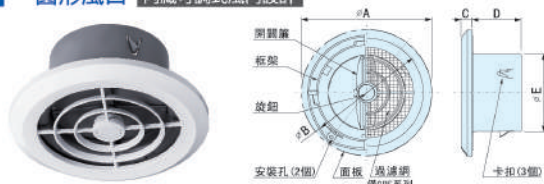

型號	尺寸					適用管道直徑	過濾網	風口類型
	A	B	C	D	E			
FV-GPV075TW	120	105	13	50	68	內徑範圍($\varnothing 70 \sim \varnothing 80$) 的管道均適用	無	進氣風口
FV-GPF075TW	120	105	13	50	68	內徑範圍($\varnothing 70 \sim \varnothing 80$) 的管道均適用	有	排氣風口
FV-GPV100TW	160	142	13	60	98	內徑範圍($\varnothing 100 \sim \varnothing 110$) 的管道均適用	無	進氣風口
FV-GPF100TW	160	142	13	60	98	內徑範圍($\varnothing 100 \sim \varnothing 110$) 的管道均適用	有	排氣風口

過濾 PM2.5 系列

PM2.5 高密度淨化濾網
適用型號

PM2.5 濾網型號	適用全熱交換器型號
FY-FP15ZY1W	FY-15ZY1W
FY-FP25ZY1W	FY-25ZY1W
FY-FP35ZY1W	FY-35ZY1W
FY-FP50ZY1W	FY-50ZY1W
FY-FP65ZY1W	FY-65ZY1W
FY-FP80ZY1W	FY-80ZY1W、FY-1HZY1W
FY-FP1KZY1W	FY-1KZY1W、FY-2KZY1W
FY-FBG15TW	FY-E15PMAW
FY-FBG25TW	FY-E25PMAW
FY-FBG35TW	FY-E35PMAW

Panasonic 原廠專用部材

室外專用部材 (單位: mm)

FV-WYP101P

雙向管罩

- 機身小巧
- 安裝簡易
- 保持外觀整潔
- 防止氣流短路

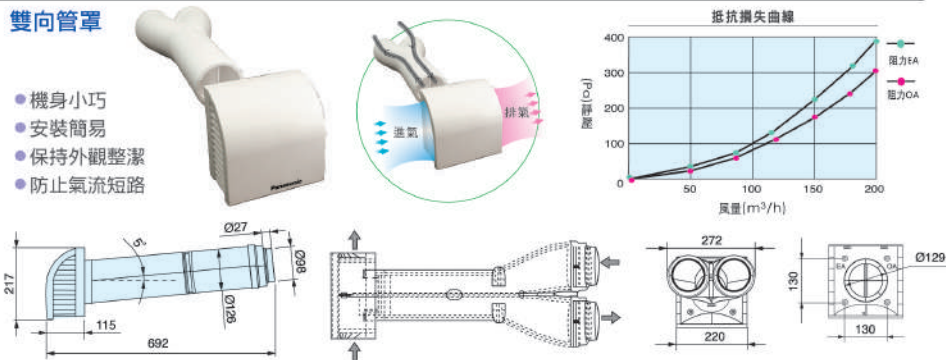

FV-BG100TW / FV-BW100TW 適用管道直徑: $\varnothing 100$
FV-BG150TW / FV-BW150TW 適用管道直徑: $\varnothing 150$

方形管罩

靜壓風量特徵曲線圖

FV-BG100TW FV-BG150TW

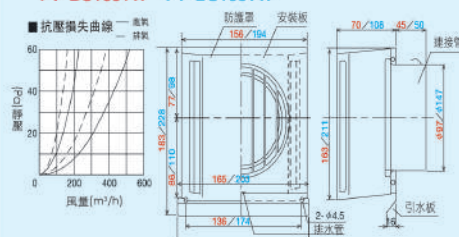

FV-BW100TW FV-BW150TW

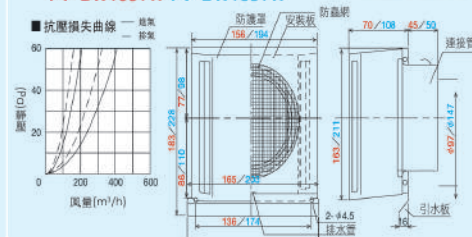

FV-VGX100TW 適用管道直徑: $\varnothing 100$
FV-VGX150TW 適用管道直徑: $\varnothing 150$

管蓋

附防蟲網



- 材料: 不銹鋼
- 防蟲網尺寸: 2.5X2.5mm

FV-MGX100TW 適用管道直徑: $\varnothing 100$
FV-MGX150TW 適用管道直徑: $\varnothing 150$

管蓋

附防蟲網



- 材料: 不銹鋼
- 防蟲網尺寸: 2.5X2.5mm

FV-VCX100TW 適用管道直徑: $\varnothing 100$
FV-VCX150TW 適用管道直徑: $\varnothing 150$

管蓋

無防蟲網



- 材料: 不銹鋼

FV-MCX100TW 適用管道直徑: $\varnothing 100$
FV-MCX150TW 適用管道直徑: $\varnothing 150$

管蓋

無防蟲網



- 材料: 不銹鋼