

# Panasonic

Operating Instructions  
(Household) Hair Dryer

Model No. EH-NE20  
EH-ND30

<b>English</b> .....	<b>3</b>
<b>中文</b> .....	<b>13</b>
<b>한글</b> .....	<b>23</b>
<b>ไทย</b> .....	<b>33</b>
<b>Tiếng Việt</b> .....	<b>43</b>
<b>Bahasa Indonesia</b> .....	<b>53</b>

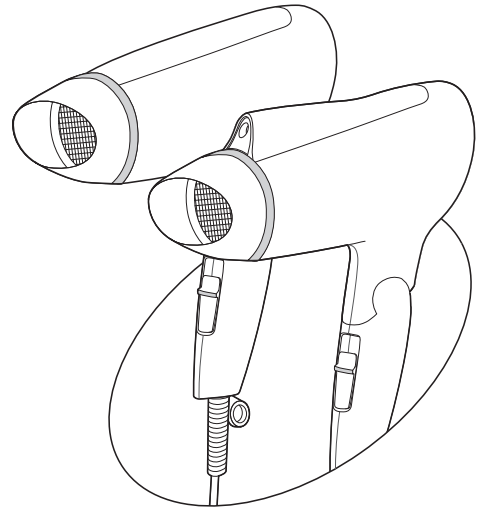



## Operating Instructions (Household) Hair Dryer

Model No. EH-NE20  
EH-ND30

### Contents

---

<b>Safety precautions.....</b>	<b>4</b>	<b>About Heat Protection .....</b>	<b>9</b>
<b>Parts identification .....</b>	<b>8</b>	<b>Maintenance of the hair dryer .....</b>	<b>10</b>
<b>How to use the hair dryer .....</b>	<b>9</b>	<b>Troubleshooting .....</b>	<b>11</b>
<b>About ion (EH-NE20 only).....</b>	<b>9</b>	<b>Specifications .....</b>	<b>11</b>

Thank you for purchasing this Panasonic product.

**Before operating this unit, please read these instructions completely and save them for future use.**

## Safety precautions

To reduce the risk of injury, loss of life, electric shock, fire, and damage to property, always observe the following safety precautions.

### Explanation of symbols

The following symbols are used to classify and describe the level of hazard, injury, and property damage caused when the denotation is disregarded and improper use is performed.



## WARNING

Denotes a potential hazard that could result in serious injury or death.



## CAUTION

Denotes a hazard that could result in minor injury or property damage.

The following symbols are used to classify and describe the type of instructions to be observed.



This symbol is used to alert users to a specific operating procedure that must not be performed.



This symbol is used to alert users to a specific operating procedure that must be followed in order to operate the unit safely.

Illustrations in “Safety precautions” may vary from the actual product.



## WARNING



**Do not store within the reach of children or infants. Do not let them use it.**

- Doing so may cause burn, electric shock, or injury.



**Never modify, disassemble, or repair.**

- Doing so may cause ignition or injury due to abnormal operation.

Contact an authorized service center for repair.



**Do not damage or modify, or forcefully bend, pull, or twist the cord. Also, do not place anything heavy on or pinch the cord.**

- Doing so may cause electric shock or fire due to a short circuit.



**Do not use with the cord bundled.**

- Doing so may cause fire or electric shock.



**Do not wrap the cord around the main body when storing.**

- Doing so may cause the wire in the cord to break with the load, and may cause electric shock or fire due to a short circuit.

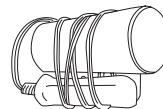

**Do not use when the plug or cord is damaged or hot.**

- Doing so may cause burn, electric shock, or fire due to a short circuit.



# WARNING



**Never use the appliance if the plug fits loosely in a household outlet.**

- Doing so may cause burn, electric shock, or fire due to a short circuit.



**Do not connect or disconnect the plug to a household outlet with a wet hand.**

- Doing so may cause electric shock or injury.



**Do not use the appliance with a wet hand.**

- Doing so may cause electric shock or fire due to a short circuit.



**Do not leave the area with the power switch left on.**

- Doing so may cause fire.



**Do not store the appliance in a bathroom or location with high humidity. Also, do not place in a location where water may spill (such as top of a vanity).**

- Doing so may cause electric shock or fire.



**Do not block, or insert hair pins or other foreign objects into the air inlet, air outlet, or ion outlet.**

- Doing so may cause fire, electric shock, or burn.



**Do not use in proximity of flammable materials (such as alcohol, benzene, thinner, spray, hair care product, nail polish remover).**

- Doing so may cause an explosion or fire.



**This appliance is not designed for commercial use, and is not intended for use without appropriate maintenance.**

- Doing so may cause burn or fire due to a continuous load or overload.



**Do not immerse the appliance in water.**

**Do not use the appliance near water.**

**Do not use the appliance near bathtubs, showers, basins or other vessels containing water.**

- Doing so may cause electric shock or fire.



**This symbol on the appliance means “Do not use the appliance near water”.**

**Immediately stop using and remove the plug if there is an abnormality or malfunction.**

- Failure to do so may cause fire, electric shock, or injury.



**<Abnormality or malfunction cases>**

• **Air is not emitted**

• **Unit stops sporadically**

• **Interior becomes red hot and smoke is emitted**

- Immediately request inspection or repair at an authorized service center.

**Use the household outlet alone: do not use with an extension cord.**

**Fully insert the plug.**



**Always ensure the appliance is operated on an electric power source matched to the rated voltage indicated on the appliance.**

- Failure to do so may cause fire or electric shock.



**When you see sparks around the air outlet while using the hot air setting, stop use and remove the lint on the air outlet and air inlet.**

- Failure to do so may cause burn or fire.



## WARNING



**Always turn OFF the power switch and disconnect the plug from the household outlet after use.**

- Failure to do so may cause fire or burn.

**Disconnect the plug by holding onto it instead of pulling on the cord.**



- Failure to do so may cause the wire in the cord to break, and may cause burn, electric shock, or fire due to a short circuit.

**Regularly clean the plug to prevent dust from accumulating.**



- Failure to do so may cause fire due to insulation failure caused by humidity.

Disconnect the plug and wipe with a dry cloth.

**When the appliance is used in a bathroom, unplug it after use since the proximity of water presents a hazard even when the appliance is switched off.**



- Failure to do so may cause an accident or injury.

**For additional protection, the installation of a residual current device (RCD) having a rated residual operating current not exceeding 30 mA is advisable in the electrical circuit supplying the bathroom. Ask your installer for advice.**



- Failure to do so may cause an accident or injury.



**This appliance is not intended for use by persons (including children) with reduced physical, sensory or mental capabilities, or lack of experience and knowledge, unless they have been given supervision or instruction concerning use of the appliance by a person responsible for their safety. Children should be supervised to ensure that they do not play with the appliance.**

- Failure to do so may cause an accident or injury.



**If the supply cord is damaged, it must be replaced by the manufacturer, its service agent, or similarly qualified persons in order to avoid a hazard.**

- Failure to do so may cause an accident or injury.



## CAUTION

**Do not store the cord in a twisted state.**



- Doing so may cause the wire in the cord to break with the load, and may cause electric shock or fire due to a short circuit.



**Do not drop or subject to shock.**

- Doing so may cause electric shock or ignition.



**Do not use with the air inlet damaged.**

- Your hair may get tangled in the air inlet, which could damage the hair.



**Do not touch the air outlet, and set nozzle, which will become very hot.**

- Doing so may cause burn.



**Do not use on infants.**

- Doing so may cause burn.



# CAUTION

**When unfolding or folding the handle, do not touch the shaded area as shown in figures below.**

- Doing so may cause finger injury.

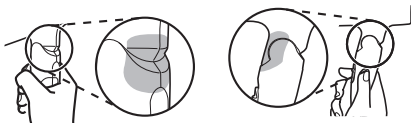

**Do not look into the air outlet while in use.**

- The hair dryer blows air with dust, etc. possibly resulting in injury.



**Be sure to keep a distance of over 3 cm between the air outlet and your hair.**

- Failure to do so may result in your hair being burned.

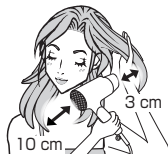

**Be sure to keep your hair at least 10 cm away from the air inlet.**

- Your hair may get tangled in the air inlet, which could damage the hair.



**Only use for drying or styling human hair. (Do not use on pets, or to dry clothing, shoes, etc.)**

- Failure to do so may cause fire or burn.

## ► Note

- This appliance is equipped with an automatic overheating protective device. If the appliance overheats, it will switch to cool air mode. Switch off the appliance and unplug it from the household outlet. Allow it to cool down for a few minutes before using it again. Check that no dust, hair, etc. is in the air inlet and air outlet before switching it on again.

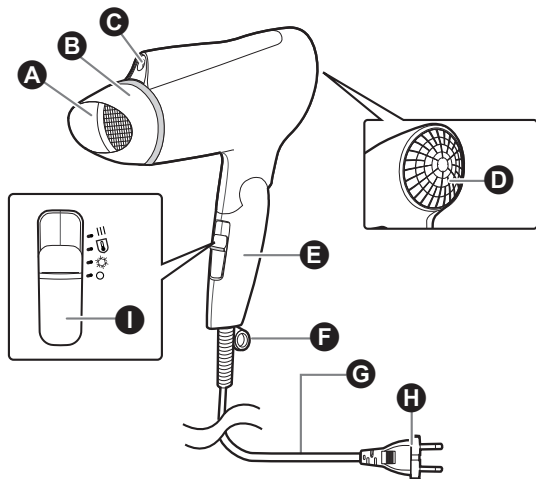

- A** Air outlet
- B** Set nozzle
- C** Ion outlet **EH-NE20 only**
- D** Air inlet
- E** Handle
- F** Ring for hanging
- G** Cord
- H** Plug

The shape of the plug differs depending on the area.

### **I** Power switch

- |   |  |
|---|--|
|   | Turbo<br>(Strong hot airflow)            |
| U | Heat Protection<br>(Strong warm airflow) |
| ☀ | Strong Cool<br>(Strong cool airflow)     |
| ○ | Off                                      |

(Some instructions only use the illustrations of EH-NE20 model to explain the product.)



## How to use the hair dryer

- 1** Before using the hair dryer, confirm that the power switch is at position “○”, then plug into a household outlet and turn on the power switch.
- 2** Select the intensity of the airflow with the power switch, and then dry your hair.
- 3** Set the power switch to position “○”, and then remove the plug from the household outlet.

### ► Set nozzle

For easy styling and blow-drying of hair, attach the set nozzle to the hair dryer.

- Set nozzle helps to direct the airflow onto a specific area of the hair.

## About ion (EH-NE20 only)

Ions are particles that combine negatively charged oxygen and moisture in the air, and cannot be seen through the naked eye.

(Ion generation method: High-voltage discharge)

### ► Notes

- You may notice a characteristic odor when using this hair dryer. This is not harmful to the human body.
- The effects of ion might not be felt by the following people. People with crimped hair, strong curly hair, very smooth hair, short hair, or who have had a hair straightening perm in the last three or four months.

## About Heat Protection

This mode provides constant and warm temperature to protect hair and scalp from heat.

## Maintenance of the hair dryer

Make sure to turn OFF the power switch and disconnect the plug from the household outlet. (Except when performing maintenance on the air outlet)

### Maintaining the hair dryer

Clean the main body when the hair dryer gets dirty.

Clean the housing only with a soft cloth slightly dampened with tap water or soapy tap water.

#### ► Notes

- Do not use alcohol, polish remover, or detergent (liquid hand soap, etc.).
  - Doing so may cause malfunction, cracking/discoloration of parts, etc.
- Leaving the hair dryer with hair products or makeup still adhered to the handle or body may degrade the plastic, causing discoloration or cracking, and malfunction.

### Maintaining the air inlet

Clean the air inlet once a month or over.

- Wipe to clean lint, hair, or other matter from the air inlet with a tissue or toothbrush.

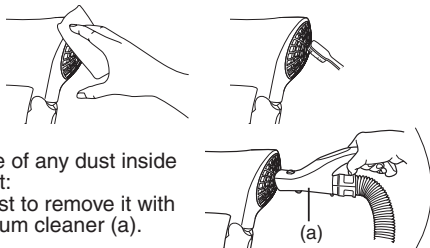

(In case of any dust inside air inlet:  
Suggest to remove it with a vacuum cleaner (a).

#### ► Note

- Do not press or rub the air inlet with a nail or other sharp object.
  - Doing so may damage the air inlet.

## Maintaining the air outlet

Clean the air outlet once a month or over.  
Scrub to remove any dust, hair, etc. blocking the mesh.

- The hair dryer should be plugged into the household outlet only in case of maintenance for the air outlet.
- Set the power switch to “⚙” and use cool airflow to blow away the dust, etc., as you scrub with the toothbrush.

#### ► Notes

- During maintenance, do not block the air inlet with your hands, etc.
- During or after maintenance of the air outlet, dust, etc. may scatter. Ensure that the hair dryer blows no dust, etc. from the air outlet before using. (Do not look into the air outlet.)

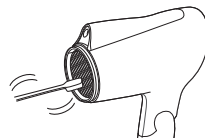

(Use a commercially available toothbrush.)

## Maintaining the ion outlet (EH-NE20 only)

Clean the ion outlet about once every 6 months.

This maintenance allows the hair dryer to sustain the generated level of ion over a long period.

- Use commercially available cotton swabs. (We recommend the thin cotton swabs made for use with babies.)
- Softly insert the cotton swab until it stops (approximately 6 mm), and turn it softly for 2 or 3 times.

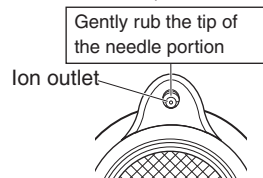

## Troubleshooting

Problem	Possible cause	Action
It switches frequently to cool air while using in "Hot" mode, or sparks can be seen within the body. (These sparks are caused by the thermostat switch, the protective device, and are not dangerous.)	▶ Lint has accumulated on the air inlet or air outlet. Hair or something is blocking the air inlet.	▶ Remove accumulated lint. Do not block the air inlet.
The hot air repeatedly turns into cool air.	▶	
The hot air is abnormally hot.	▶	
The plug is abnormally hot.	▶ The connection to the household outlet is loose.	▶ Use a household outlet that fits securely.
Sparks are generated inside the ion outlet. (EH-NE20 only)	▶	
The ion outlet emits a noise (crackling noise). (EH-NE20 only)	▶ Abnormality caused by a dirty electrode (needle portion).	▶ Perform maintenance of the ion outlet.

If the problems still cannot be solved, contact the store where you purchased the unit or a service center authorized by Panasonic for repair.

## Specifications

Product name	Hair Dryer		
Product model	EH-NE20, EH-ND30		
Power source	220 V ~ 50 - 60 Hz	230 V ~ 50 - 60 Hz	240 V ~ 50 - 60 Hz
Power consumption	1 500 W	1 650 W	1 800 W
Accessory	Set nozzle		

This product is intended for household use only.

# MEMO

English

## 目錄

安全須知.....	14	關於高溫防護 .....	19
零件說明 .....	18	保養風筒 .....	20
使用風筒的方法 .....	19	疑難排解 .....	21
關於負離子 (僅限 EH-NE20 型產品) ...	19	規格 .....	21

感謝您購買本 Panasonic 產品。  
使用本產品之前，請仔細閱讀本說明書，並妥善保存以供未來使用。

## 安全須知

為減低受傷、死亡、觸電、火災、及財物損失的風險，請務必留意以下安全須知。

### 符號說明

以下符號用於為危險、傷害及財物損失的級別分類和作出解釋。若忽視此等符號，不當使用本產品可能會導致所述的危險、人身傷害及財物損失。

 **警告** 表示潛在的危險可能會導致嚴重受傷或死亡。

 **注意** 表示危險可導致輕傷或財物損失。

以下符號用於分類和解釋必須留意的指示類型。

 此符號用於提示使用者，不得執行某項特定的操作程序。

 此符號用於提示使用者，必須遵從某項特定的操作程序，才能安全操作本產品。

「安全須知」內的插圖可能與實際產品不一致。

## 警告

 切勿將產品存放於兒童或幼童可觸及的地方。請勿讓兒童或幼童使用。  
- 否則可能會造成灼傷、觸電或受傷。

 切勿改裝、拆卸或維修本產品。  
- 否則可能會導致著火，或因異常操作而造成傷害。  
請聯絡 Panasonic 直屬服務站進行維修。

 切勿損壞、改裝、用力彎曲、拉扯或纏繞電源線。此外，切勿將重物放在電源線上或夾緊電源線。  
- 否則可能會因短路而導致觸電或火災。

 切勿在使用時將電源線纏綁在一起。  
- 否則可能引起火災或觸電。

儲藏時，切勿將電源線纏繞住本機主體。

 否則可令電源線內的電線因負荷而斷裂，並導致觸電或因短路而引起火災。

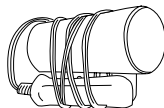

 當插頭或電源線損壞或發熱時，切勿使用。  
- 否則可能會造成灼傷、觸電或因短路而引起火災。

 如果插頭在家用電源插座內有鬆動現象，切勿使用本產品。  
- 否則可能會造成灼傷、觸電或因短路而引起火災。

## 警告



切勿在手濕時將電源插頭插入家用電源插座或將其從插座中拔除。

- 否則可導致觸電或受傷。



切勿在手濕時使用本產品。

- 否則可能會因短路而導致觸電或火災。



當電源開關開啟時，切勿離開該區域。

- 否則可能造成火災。



切勿將本產品放置在浴室或濕度很高的地方。另外，請不要將其放置在可能會潑濺到水的地方（例如，洗手間台頂部）。

- 否則可能造成觸電或火災。



切勿堵塞或插入髮夾或其他異物到入風口、出風口或負離子出風口。

- 否則可能造成火災、觸電或灼傷。



切勿在有易燃物質（例如，酒精、揮發油、稀釋劑、噴霧、護髮產品、洗甲水）附近使用。

- 否則可能造成爆炸或火災。



本產品並非設計用於商業用途，請在適當的保養下使用。

- 否則可能會因連續負荷或超負荷而導致灼傷或火災。

切勿將本產品浸入水中。

切勿在靠水的地方使用本產品。

切勿在靠近浴缸、蓮蓬頭、水盆或其他裝水的容器附近使用本產品。

- 否則可能造成觸電或火災。



位於產品上的這個符號表示「切勿在靠水的地方使用本產品」。

如果出現異常或故障，請立即停止使用並拔除電源插頭。

- 否則可能會造成火災、觸電或受傷。

<異常或故障情況>

• 無法送風

• 本機出現偶爾停止的現象

• 內部變成火紅炙熱狀且冒煙

- 請立即將產品帶往 Panasonic 直屬服務站，以要求檢查或維修。

請使用獨立的家用電源插座：切勿搭配延長電源線使用。

請完全插入電源插頭。





請務必確保在符合本產品上指定的額定電壓的電源上操作本產品。

- 否則可能造成火災或觸電。

使用熱風設定時，如果您看到出風口處出現火花，請停止使用並清除出風口與入風口處的棉絮。

- 否則可能造成灼傷或火災。





## 警告

-  使用後，請務必關閉電源開關並從家用插座拔除電源插頭。
  - 否則可能造成火災或灼傷。
-  拔除電源插頭時，請握住插頭，不要拉扯電源線。
  - 否則可能造成電源線中的電線斷裂，並導致灼傷、觸電或因短路而導致火警。
-  請定期清潔電源插頭，避免灰塵堆積。
  - 否則濕氣可令絕緣失效，引起火災。請拔除電源插頭並使用乾布擦拭。
-  若在浴室中使用本產品，使用完畢後請拔下電源插頭，因為即使本產品已經關掉，它在接近水時仍然存在危險。
  - 否則可能導致意外或受傷。
-  為了保護您的安全，建議您在浴室的供電電路中安裝一個額定漏電動作電流不超過 **30 mA** 的漏電保護開關 (RCD)。請諮詢安裝者以獲得建議。
  - 否則可能導致意外或受傷。

-  體能、感官或智力減退，或缺乏經歷和知識之人士（含小孩），在無人監護或未獲告知如何使用的情况下不得使用本產品。
  - 請勿讓兒童使用本產品。
  - 否則可能導致意外或受傷。

-  如果本機的電源線已經損壞，務必立即停止使用，並送交 **Panasonic** 直屬服務站進行更換。
  - 否則可能導致意外或受傷。

## 注意

-  切勿以纏繞的方式貯存電源線。
  - 否則可令電源線內的電線因負荷而斷裂，並導致觸電或因短路而引起火災。
-  切勿墜落產品或使其受到撞擊。
  - 否則可能造成觸電或著火。
-  當入風口損壞時，切勿使用。
  - 您的頭髮可能會被卷入入風口，這會讓頭髮受損。
-  切勿接觸出風口及造型風咀，這些部位溫度非常高。
  - 否則可能造成灼傷。
-  切勿對幼童使用。
  - 否則可能造成灼傷。



## ⚠ 注意

拉長或縮回把手時，切勿接觸下圖所示的陰影區域。  
- 否則可能造成手指受傷。

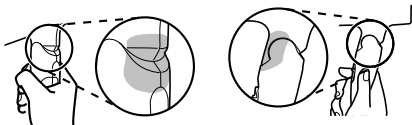

使用期間切勿向出風口內看。  
- 用風筒吹灰塵等可能會造成傷害。



請確保您的頭髮與出風口之間保持  
超過 **3 cm** 的距離。  
- 否則可能造成您的頭髮被燒焦。

確保您的頭髮與入風口保持最少  
**10 cm** 的距離。

- 您的頭髮可能會被卷入入風口，這  
會讓頭髮受損。

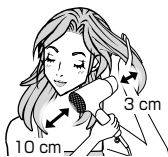

請僅用於吹乾或造型頭髮。（切勿用於寵物或吹乾衣物、烘鞋等用途。）  
- 否則可能造成火災或灼傷。

## ▶ 註

- 本產品配備一個自動防止過熱裝置。如果產品過熱，將轉換到強冷。請關閉本產品，並從家用插座中拔除。等讓風筒冷卻數分鐘後再使用。再次開啟風筒前，請檢查入風口與出風口內無灰塵、頭髮等。

## 零件說明

中文

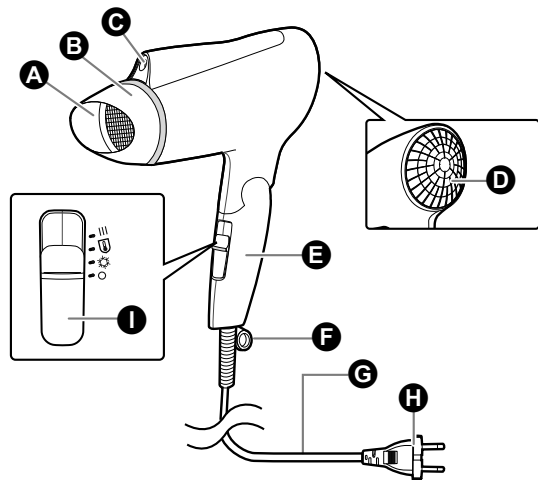

- A 出風口
- B 造型風咀
- C 負離子出風口 僅限 **EH-NE20** 型產品
- D 入風口
- E 把手
- F 掛環
- G 電源線
- H 插頭

電源插頭的形狀視地區而異。

### I 電源開關

- III 增壓渦輪  
(強熱風)
- U 高溫防護  
(強暖風)
- ⚙ 強冷  
(強冷風)
- 關閉

(一些說明書僅使用 EH-NE20 型號插圖來解釋產品。)

## 使用風筒的方法

- 1 使用風筒前，確認電源開關位於「○」位置，然後將插頭插入插座並打開電源開關。
- 2 使用電源開關選擇風力強度，然後將頭髮吹乾。
- 3 將電源開關調至「○」位置，然後從家用插座上拔除插頭。

### ▶造型風咀

為了對頭髮進行簡易造型和吹乾，可以在風筒上安裝造型風咀。

- 造型風咀有助於將風力集中在頭髮的特定區域。

## 關於負離子（僅限 EH-NE20 型產品）

負離子是帶負電荷的氧氣與空氣中的濕氣結合所產生的分子，並且無法以肉眼看見。

（負離子產生方法：高壓放電）

### ▶註

- 使用風筒時可能會聞到一種特別的氣味。這對人體無害。
- 以下髮型的人可能感覺不到負離子的效果：  
有波浪形的頭髮、牢固的捲髮、特別平順的頭髮、短髮，或三四個月前曾燙直過頭髮的人。

## 關於高溫防護

這種模式提供持續且較暖的溫度，以防止過熱的溫度對頭髮和頭皮造成傷害。

## 保養風筒

請務必關閉電源開關並從家用插座拔除插頭。（對出風口進行保養時除外）

### 風筒的保養

風筒髒污時，清潔本機主體。

請以自來水或肥皂水稍微浸濕的軟布來清潔外殼。

#### ▶ 註

- 切勿使用酒精、洗甲水或清潔劑（洗手液等）。
  - 否則可能導致產品故障、零件破裂或褪色等。
- 不去除黏附在風筒手把或機身上的髮型用品或化妝品，可能會使塑料分解，導致產品褪色或破裂及導致產品故障。

### 入風口的保養

清潔入風口，每月一次或以上。

- 請使用衛生紙或牙刷將入風口的棉絮、頭髮或其他東西擦拭乾淨。

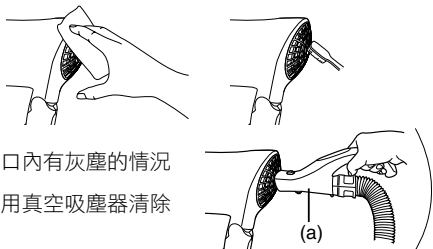

#### ▶ 註

- 切勿使用指甲或其他尖銳物體按壓或摩擦入風口。
  - 否則可能會損壞入風口。

## 出風口的保養

清潔出風口，每月一次或以上。  
刷去塵埃、頭髮等阻擋網孔的物體。

- 若僅保養出風口時，才應該將風筒插入到家用電源插座。
- 將電源開關調至「❄️」使用冷風，再用牙刷刷出灰塵時將其吹走。

#### ▶ 註

- 保養期間，切勿以手或其他物件阻擋入風口。
- 在保養出風口期間或之後，灰塵等可能會四處都是。在使用前確保風筒不會從出風口吹出灰塵等。（切勿向出風口內看。）

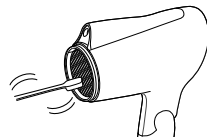

（使用市售的牙刷。）

## 負離子出風口的保養（僅限 EH-NE20 型產品）

清潔負離子出風口，約每 6 個月一次。

這項保養可使風筒長期保持產生負離子的水平。

- 使用市面上有售的棉花棒。（建議使用嬰兒適用的薄棉花棒。）
- 輕輕插入棉花棒直至停止（約 6 mm），然後輕輕轉動 2 或 3 次。

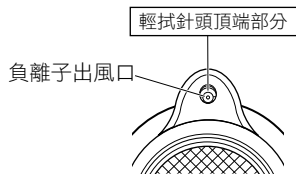

## 疑難排解

問題	導致故障原因	措施
使用「熱風」模式時，如果頻繁地切換到冷風，可能會在本機內部看見火花。 (這些火花是因恆溫開關、保護裝置造成，不會造成危險。)	棉絮堆積在入風口或出風口。 在入風口有堵塞頭髮或其他東西。	清除堆積的棉絮。 切勿堵塞入風口。
熱風反復變為冷風。		
熱風異常高溫。		
插頭異常高溫。	與家用插座的連接鬆動。	請使用能穩固固定的家用插座。
在負離子出風口內部產生火花。 (僅限 EH-NE20 型產品)	由於電極髒污所造成的異常(針尖部位)。	請進行負離子出風口保養。
負離子出風口有異音(爆裂聲)。 (僅限 EH-NE20 型產品)		

如果仍然無法解決問題，請與您購買本機的商店聯繫，或聯絡 Panasonic 直屬服務站進行維修。

## 規格

產品名稱	風筒		
產品機型	EH-NE20, EH-ND30		
電源	220 V~ 50 - 60 Hz	230 V~ 50 - 60 Hz	240 V~ 50 - 60 Hz
消耗電量	1 500 W	1 650 W	1 800 W
配件	造型風咀		

此產品只適於家居內使用。

# MEMO



文中

## 목차

---

안전 주의사항.....	24	열 보호 정보 .....	29
각부 설명.....	28	헤어 드라이어 유지 관리.....	30
헤어 드라이어 사용 방법.....	29	문제 해결.....	31
이온 정보(EH-NE20만 해당).....	29	사양.....	31

본 Panasonic 제품을 구입해 주셔서 감사합니다.

본 기기를 작동하기 전에 본 설명서를 자세히 읽고 나중에 사용할 수 있도록 보관하십시오.

## 안전 주의사항

부상, 사망, 감전, 화재 및 재산 손실 위험을 방지하려면 항상 다음 안전 주의사항을 준수하십시오.

### 기호 설명

다음 기호는 지침을 무시하고 잘못 사용할 경우 발생할 수 있는 부상이나 재산 손실의 위험도를 분류하고 설명하는 데 사용됩니다.

 **경고** 중상이나 사망에 이를 수 있는 잠재적 위험을 나타냅니다.

 **주의** 경상을 입거나 재산이 손실될 수 있는 위험을 나타냅니다.

다음 기호는 준수해야 하는 지침 유형을 분류하고 설명하는 데 사용됩니다.

 이 기호는 수행해서는 안 되는 특정 작동 절차를 사용자에게 알려줍니다.

 이 기호는 기기를 안전하게 작동하기 위해 따라야 하는 특정 작동 절차를 사용자에게 알려주는 데 사용됩니다.

"안전 주의사항" 표시는 실제 제품과는 다를 수 있습니다.

## 경고

 어린이나 유아가 접근할 수 있는 장소에 보관하지 마십시오. 어린이나 유아가 사용하지 않도록 하십시오.  
- 화상을 입거나 감전되거나 부상을 당할 수 있습니다.

 개조하거나 분해하거나 수리하지 마십시오.  
- 비정상적인 작동으로 인해 화재가 발생하거나 부상을 당할 수 있습니다.  
공인 서비스 센터에 수리를 의뢰하십시오.

 코드를 손상 또는 변형시키거나 무리하게 구부리거나 당기거나 꼬지 마십시오. 또한 코드 위에 무거운 물건을 올려놓거나 코드가 끼이지 않도록 하십시오.  
- 합선으로 인해 감전되거나 화재가 발생할 수 있습니다.

 코드를 묶어서 사용하지 마십시오.  
- 화재가 발생하거나 감전될 수 있습니다.

**보관 시 본체에 코드를 감지**  
마십시오.

 - 부하로 인해 전선이 파손되고 합선으로 인해 감전되거나 화재가 발생할 수 있습니다.

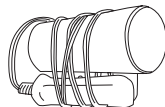

 플러그나 코드가 손상되었거나 뜨거운 경우 사용하지 마십시오.  
- 합선으로 인해 화상을 입거나 감전되거나 화재가 발생할 수 있습니다.



## ⚠ 경고

❌ 플러그를 가정용 콘센트에 헐겁게 꽂은 상태로 기기를 사용하지 마십시오.

- 합선으로 인해 화상을 입거나 감전되거나 화재가 발생할 수 있습니다.

❌ 젖은 손으로 가정용 콘센트에 플러그를 꽂거나 뽑지 마십시오.

- 감전되거나 부상을 당할 수 있습니다.

❌ 젖은 손으로 기기를 사용하지 마십시오.

- 합선으로 인해 감전되거나 화재가 발생할 수 있습니다.

❌ 전원 스위치가 켜진 상태에서 자리를 비우지 마십시오.

- 화재가 발생할 수 있습니다.

❌ 욕실이나 습도가 높은 장소에 기기를 보관하지 마십시오. 또한 물이 스며들 수 있는 장소에 두지 마십시오(세면대 위 등).

- 감전되거나 화재가 발생할 수 있습니다.

❌ 공기 흡입구, 공기 배출구 또는 이온 배출구를 막거나 머리핀 또는 기타 이물질을 넣지 마십시오.

- 화재가 발생하거나 감전되거나 화상을 입을 수 있습니다.

❌ 인화성 물질(알코올, 벤젠, 시너, 스프레이, 헤어 케어 제품, 매니큐어 제거제 등) 근처에서 사용하지 마십시오.

- 폭발이나 화재가 발생할 수 있습니다.

❌ 본 기기는 상업용으로 설계되지 않았으며, 적절한 유지 관리 없이는 사용할 수 없습니다.

- 지속적인 부하 또는 과부하로 인해 화상이나 화재가 발생할 수 있습니다.

기기를 물에 담그지 마십시오.

물 근처에서 기기를 사용하지 마십시오.

❌ 욕조, 샤워 시설, 세면기 또는 물이 들어 있는 기타 용기가 가까이에서 기기를 사용하지 마십시오.

- 감전되거나 화재가 발생할 수 있습니다.



기기에 표시된 이 기호는 “물 근처에서 기기를 사용하지 말 것”을 의미합니다.

오작동이나 작동 불량 시 즉시 사용을 멈추고 플러그를 뽑으십시오.

- 화재가 발생하거나 감전되거나 부상을 당할 수 있습니다.

❗ <오작동 또는 작동 불량일 경우>

• 바람이 나오지 않습니다.

• 기기가 이따금 멈춥니다.

• 내부가 빨갛게 뜨거워지고 연기가 납니다.

- 즉시 공인 서비스 센터에 점검이나 수리를 요청하십시오.

가정용 콘센트만 사용하십시오. 연장 코드를 사용하지 마십시오.

❗ 플러그를 확실하게 꽂으십시오.

항상 기기에 표시된 정격 전압과 일치하는 콘센트에만 연결해 사용하십시오.

- 그렇지 않으면 화재가 발생하거나 감전될 수 있습니다.

❗ 온풍 설정으로 사용하는 동안 공기 배출구 주위에서 스파크가 발생한 경우 사용을 멈추고 공기 배출구와 공기 흡입구에서 보풀을 제거하십시오.

- 그렇지 않으면 화상을 입거나 화재가 발생할 수 있습니다.

## 경고

**사용 후 항상 전원 스위치를 끄고 가정용 콘센트에서 플러그를 뽑으십시오.**



- 그렇지 않으면 화재가 발생하거나 화상을 입을 수 있습니다.

**코드를 당기지 말고 플러그를 잡고 뽑으십시오.**



- 그렇지 않으면 전선이 파손되고 합선으로 인해 화상을 입거나 감전되거나 화재가 발생할 수 있습니다.

**정기적으로 플러그를 청소하여 먼지가 쌓이지 않도록 하십시오.**



- 그렇지 않으면 습기로 인해 절연되지 않아서 화재가 발생할 수 있습니다.  
플러그를 뽑고 마른 천으로 닦으십시오.

**기기 전원이 꺼져 있더라도 물 근처는 위험하므로 욕실에서 기기를 사용하는 경우 사용 후에 플러그를 뽑으십시오.**



- 그렇지 않으면 사고가 발생하거나 부상을 입을 수 있습니다.

**더 안전한 사용을 위해 화장실에 공급되는 전기 회로에 잔류 작동 전류가 30 mA를 넘지 않는 잔류 전류 차단 장치(RCD)를 설치하는 것이 좋습니다. 전문가에게 설치를 의뢰하십시오.**



- 그렇지 않으면 사고가 발생하거나 부상을 입을 수 있습니다.

이 기기는 신체, 감각, 정신 능력이 결여되어 있거나 경험과 지식이 부족하여 감독이나 지시 없이 안전하게 기기를 사용할 수 없는 사람(어린이 포함)이 사용하도록 만들어지지 않았다.



어린이가 기기를 가지고 놀지 않도록 어린이를 감시하는 것이 좋다.

- 이렇게 하지 않으면 사고나 부상을 초래할 수 있습니다.

**전원 코드가 파손된 경우 위험을 피하기 위해 제조사나 공식 서비스 센터 또는 기타 자격을 갖춘 전문 기술자가 코드를 교체해야 합니다.**



- 그렇지 않으면 사고가 발생하거나 부상을 입을 수 있습니다.

## 주의

**전원 코드가 꼬인 상태로 보관하지 마십시오.**



- 부하로 인해 전선이 파손되고 합선으로 인해 감전되거나 화재가 발생할 수 있습니다.

**떨어뜨리거나 충격을 주지 마십시오.**



- 감전되거나 화재가 발생할 수 있습니다.

**공기 흡입구가 파손된 상태로 사용하지 마십시오.**



- 공기 흡입구에서 머리카락이 꼬여 머리카락이 손상될 수 있습니다.

**공기 배출구와 설정 노즐을 만지지 마십시오. 고온일 수 있습니다.**



- 화상을 입을 수 있습니다.

**유아에게 사용하지 마십시오.**



- 화상을 입을 수 있습니다.

## ⚠ 주의

손잡이를 펴거나 접을 때 아래 그림에서 음영으로 표시된 부분을 만지지 마십시오.

- 손가락이 다칠 수 있습니다.

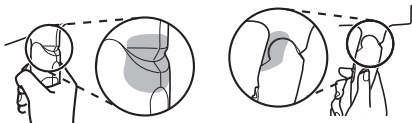

사용 중에 공기 배출구를 쳐다보지 마십시오.

- 헤어 드라이어에서 먼지와 함께 바람이 배출되어 부상을 입을 수 있습니다.



공기 배출구와 머리 사이의 거리를

3 cm 이상으로 유지하십시오.

- 그렇지 않으면 머리카락이 탈 수 있습니다.

머리를 공기 흡입구에서 최소 10 cm 이상 떨어뜨리십시오.

- 공기 흡입구에서 머리카락이 꼬여 머리카락이 손상될 수 있습니다.

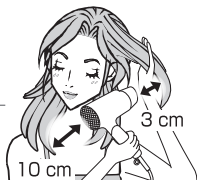

머리카락을 건조시키거나 스타일링할 때에만 사용하십시오. (애완동물에게 사용하거나 옷, 신발 등을 건조시키기 위해 사용하지 마십시오.)

- 그렇지 않으면 화재가 발생하거나 화상을 입을 수 있습니다.

## ▶ 참고

- 본 기기에는 자동 과열 보호 장치가 탑재되어 있습니다. 기기가 과열되면 냉풍 모드로 전환됩니다. 기기 전원을 끄고 가정용 콘센트에서 플러그를 뽑으십시오. 몇 분 동안 기기를 식힌 후 다시 사용하십시오. 공기 흡입구와 공기 배출구에 먼지, 머리카락이 없는지 확인한 후 전원을 다시 켜십시오.

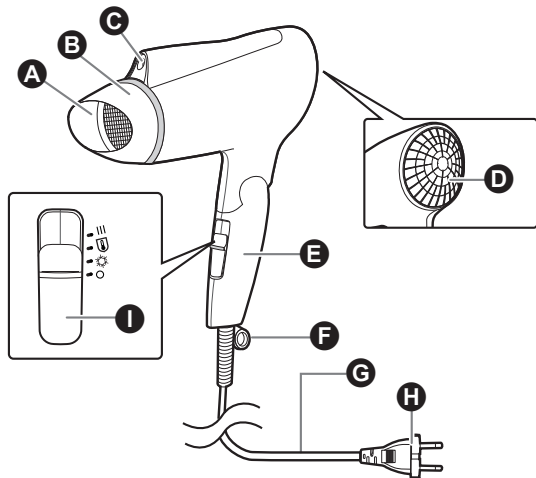

- A 공기 배출구
- B 설정 노즐
- C 이온 배출구 **EH-NE20만 해당**
- D 공기 흡입구

- E 손잡이
- F 걸기용 고리
- G 코드
- H 플러그

플러그 모양은 지역마다 다릅니다.

**I 전원 스위치**

- III 터보  
(매우 뜨거운 바람)
- U 열 보호  
(매우 따뜻한 바람)
- ☀ 냉풍  
(매우 시원한 바람)
- 꺼짐

(일부 지점은 EH-NE20 모델 그림만 사용하여 제품을 설명합니다.)

## 헤어 드라이어 사용 방법

- 1 헤어 드라이어를 사용하기 전에 전원 스위치가 "○" 위치에 있는지 확인한 후 가정용 콘센트에 플러그를 꽂고 전원 스위치를 켭니다.
- 2 전원 스위치로 바람 세기를 선택한 후 머리를 건조시킵니다.
- 3 전원 스위치를 "○" 위치로 설정한 후 가정용 콘센트에서 플러그를 뽑습니다.

### ▶설정 노즐

손쉬운 스타일링과 머리카락 건조를 위해 헤어 드라이어에 설정 노즐을 부착할 수 있습니다.

- 설정 노즐을 통해 머리의 특정 부위에 바람을 직접 쐬 수 있습니다.

## 이온 정보(EH-NE20만 해당)

이온은 음전하 산소와 공기 중의 수분이 결합된 물질이며 육안으로는 볼 수 없습니다.

(이온 생성 방법: 고전압 방출)

### ▶참고

- 헤어 드라이어 사용 중에 특이한 냄새가 날 수 있습니다. 이는 신체에 유해하지 않습니다.
- 다음 사람에게는 이온 효과가 없을 수 있습니다. 곱슬 머리, 컬이 심한 머리카락, 매우 부드러운 머리카락, 단발인 사람 또는 최근 3, 4개월 내에 스트레이트 펴를 한 사람

## 열 보호 정보

이 모드는 열로부터 머리카락과 두피를 보호하기 위해 따뜻한 온도를 일정하게 제공합니다.

## 헤어 드라이어 유지 관리

전원 스위치를 끄고 가정용 콘센트에서 플러그를 뽑으십시오.  
(공기 배출구 유지 관리를 실행하는 경우 제외)

### 헤어 드라이어 유지 관리

헤어 드라이어가 더러워진 경우 본체를 청소하십시오.  
물 또는 비누물을 살짝 적신 부드러운 천으로 하우징만 청소하십시오.

#### ▶참고

- 알코올, 매니큐어 제거제 또는 세제(액체 손 세정제 등)를 사용하지 마십시오.  
- 그렇지 않으면 고장이 발생하거나 부품에 금이 가거나 부품이 변색될 수 있습니다.
- 헤어 제품과 함께 헤어 드라이어를 보관하거나 손잡이 또는 본체에 화장품이 묻어 있으면 플라스틱이 약해져 변색되거나 금이 가거나 고장날 수 있습니다.

### 공기 흡입구 유지 관리

한 달에 한 번 이상 공기 흡입구를 청소하십시오.

- 티슈나 칫솔로 공기 흡입구의 보풀, 머리카락 또는 기타 이물질을 깨끗하게 제거하십시오.

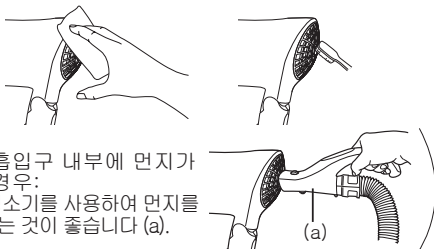

(공기 흡입구 내부에 먼지가 있는 경우:  
진공 청소기를 사용하여 먼지를 제거하는 것이 좋습니다. (a).)

#### ▶참고

- 손톱이나 기타 날카로운 물체로 공기 흡입구를 누르거나 문지르지 마십시오.  
- 공기 흡입구가 손상될 수 있습니다.

## 공기 배출구 유지 관리

한 달에 한 번 이상 공기 배출구를 청소하십시오.  
망울 막고 있는 모든 먼지, 머리카락 등을 문질러 제거하십시오.

- 공기 배출구를 유지 관리하는 경우에만 헤어 드라이어 플러그를 가정용 콘센트에 꽂으십시오.
- 전원 스위치를 "☼"로 설정하고 냉풍을 사용하여 칫솔로 문지른 먼지 등을 날리십시오.

#### ▶참고

- 유지 관리하는 동안 손으로 공기 흡입구를 막지 마십시오.
- 공기 배출구를 유지 관리하는 동안이나 후에는 먼지 등이 흩날릴 수 있습니다. 사용하기 전에 헤어 드라이어에 바람을 불어 공기 배출구에 먼지가 없도록 하십시오. (공기 배출구를 쳐다보지 마십시오.)

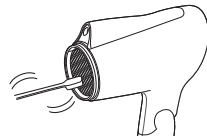

(시중에서 판매하는 칫솔을 사용하십시오.)

### 이온 배출구 유지 관리(EH-NE20만 해당)

6개월에 한 번씩 이온 배출구를 청소하십시오.

이러한 유지 관리를 통해 헤어 드라이어의 이온 성능을 장기간 유지할 수 있습니다.

- 시중에서 판매하는 면봉을 사용하십시오. (유아용으로 제조된 얇은 면봉을 사용하는 것이 좋습니다.)
- 면봉이 멈출 때까지 부드럽게 넣고(약 6 mm) 2, 3회 부드럽게 돌리십시오.

니들 부분의 끝을 부드럽게 문지릅니다.

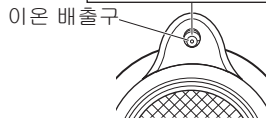

## 문제 해결

문제	원인	조치
"온풍" 모드로 사용 중에 냉풍으로 자주 변경되거나 본체 내에서 스파크를 볼 수 있다. (이러한 스파크는 서모스텝 스위치, 보호 장치로 인해 발생되며 위험하지 않습니다.)	▶ 공기 흡입구나 공기 배출구에 보풀이 쌓여 있습니다. ▶ 머리카락이나 이물질이 공기 흡입구를 막고 있습니다.	▶ 쌓여 있는 보풀을 제거하십시오. ▶ 공기 흡입구를 막지 마십시오.
온풍이 반복해서 냉풍으로 바뀐다.	▶	
온풍이 이상하게 뜨겁다.	▶	
플러그가 이상하게 뜨겁다.	▶ 가정용 콘센트로의 연결이 헐겁습니다.	▶ 확실하게 맞는 가정용 콘센트를 사용하십시오.
이온 배출구 안쪽에서 스파크가 발생한다. (EH-NE20만 해당)	▶	
이온 배출구에서 소음이 발생한다 (딱딱거리는 소리). (EH-NE20만 해당)	▶ 전극(니들 부분)이 더러워져 발생합니다.	▶ 이온 배출구를 유지 관리하십시오.

문제가 해결되지 않으면 기기를 구입처에 문의하시거나 Panasonic 공인 서비스 센터에 수리를 의뢰하십시오.

## 사양

제품명	헤어 드라이어		
제품 모델	EH-NE20, EH-ND30		
전원	220 V ~ 50 - 60 Hz	230 V ~ 50 - 60 Hz	240 V ~ 50 - 60 Hz
소비 전력	1 500 W	1 650 W	1 800 W
액세서리	설정 노즐		

본 제품은 가정용입니다.

# MEMO



19  
10



# Panasonic

คู่มือการใช้งาน  
เครื่องเป่าผม (สำหรับใช้ในบ้าน)  
EH-NE20  
หมายเลขรุ่น  
EH-ND30

## สารบัญ

ข้อควรระวังด้านความปลอดภัย.....	34	อีท โพรเทคชั่น .....	39
ส่วนต่าง ๆ ของอุปกรณ์ .....	38	การบำรุงรักษาเครื่องเป่าผม .....	40
วิธีใช้เครื่องเป่าผม .....	39	วิธีการแก้ปัญหาเครื่องเป่าผม .....	41
ไอออน (EH-NE20 เท่านั้น) .....	39	ข้อมูลทางเทคนิคสินค้า .....	41

ขอขอบคุณที่สั่งซื้อผลิตภัณฑ์ของ Panasonic  
ก่อนใช้งานเครื่องนี้ โปรดอ่านคู่มือการใช้งานโดยละเอียดและเก็บรักษาคู่มือนี้ไว้เพื่อใช้งานในอนาคต

## ข้อควรระวังด้านความปลอดภัย

เพื่อลดความเสี่ยงจากการบาดเจ็บ การเสียชีวิต ไฟฟ้าช็อต ไฟไหม้ และ ความเสียหายต่อทรัพย์สิน ควรศึกษาข้อควรระวังด้านความปลอดภัยต่อไปนี้เสมอ

### คำอธิบายของสัญลักษณ์ต่าง ๆ

สัญลักษณ์ต่อไปนี้ใช้เพื่อจำแนกกลุ่มและอธิบายถึงระดับของอันตราย การบาดเจ็บ และความเสียหายต่อทรัพย์สินอันเนื่องมาจากการละเลยต่อคำเตือน ที่ระบุไว้ และการใช้งานอย่างไม่เหมาะสม



### คำเตือน

อันตรายที่อาจเกิดขึ้นนั้นอาจส่งผลให้ได้รับบาดเจ็บอย่างร้ายแรงหรือเสียชีวิตได้



### ข้อควรระวัง

อันตรายที่อาจส่งผลให้ได้รับบาดเจ็บเล็กน้อยหรือทำให้สิ่งของเสียหาย

สัญลักษณ์ต่อไปนี้ใช้เพื่อจำแนกกลุ่มและอธิบายถึงประเภทของคำแนะนำที่ต้องสังเกต



สัญลักษณ์นี้ใช้เพื่อแจ้งเตือนผู้ใช้ถึงขั้นตอนการทำงานบางลักษณะที่ห้ามใช้งาน



สัญลักษณ์นี้ใช้เพื่อแจ้งเตือนผู้ใช้ถึงขั้นตอนการทำงานบางลักษณะที่ต้องปฏิบัติตามลำดับ เพื่อให้การใช้งานอุปกรณ์มีความปลอดภัย

ภาพประกอบใน "ข้อควรระวังด้านความปลอดภัย" อาจแตกต่างไปจากผลิตภัณฑ์จริง



## คำเตือน



อย่าเก็บไว้ใกล้มือเด็ก หรือทารก ไม่อนุญาตให้เด็กใช้งานอุปกรณ์ - อาจก่อให้เกิดไฟลวก ไฟฟ้าช็อต หรือได้รับบาดเจ็บได้



อย่าตัดแปลง แยกชิ้นส่วน หรือซ่อมแซม - อาจก่อให้เกิดประกายไฟหรือได้รับบาดเจ็บอันเนื่องมาจากการใช้งานที่ผิดพลาด  
ติดต่อศูนย์บริการที่ได้รับอนุญาตเพื่อซ่อมแซม



อย่าทำให้เกิดความเสียหาย หรือตัดแปลง หรืออง ดิ่ง หรือบิด สายไฟแรง ๆ อย่างรุนแรงของที่มีน้ำหนักมากหรือกดสายไฟ - อาจทำให้เกิดไฟฟ้าช็อต หรือไฟไหม้เนื่องจากไฟฟ้าลัดวงจรได้



อย่าใช้ในขณะที่สายไฟม้วนรวมกันอยู่ - อาจก่อให้เกิดไฟไหม้ หรือไฟฟ้าช็อตได้

ในการเก็บอุปกรณ์อย่าพันสายไฟเข้ากับตัวเครื่อง





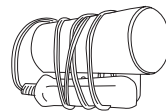







- อาจทำให้เส้นลวดภายในสายไฟขาดและอาจทำให้เกิดไฟฟ้าช็อต หรือไฟไหม้เนื่องจากไฟฟ้าลัดวงจรได้



อย่าใช้งานเมื่อปลั๊ก หรือสายไฟร้อนหรือเสียหาย - อาจทำให้เกิดการไหม้ ไฟฟ้าช็อต หรือไฟไหม้เนื่องจากไฟฟ้าลัดวงจรได้

## คำเตือน

-  อย่าใช้อุปกรณ์ หากมีการเสียบปลั๊กเข้ากับเต้ารับภายในบ้าน  
ไม่สนิท
  - อาจทำให้เกิดการไหม้ ไฟฟ้าช็อต หรือไฟไหม้เนื่องจากไฟฟ้าลัดวงจรได้
-  อย่าใช้มือที่เปียกเสียบ หรือถอดปลั๊กออกจากเต้ารับไฟภายในบ้าน
  - อาจทำให้เกิดไฟฟ้าช็อต หรือเกิดการบาดเจ็บได้
-  อย่าใช้อุปกรณ์ในขณะที่มือเปียกน้ำ
  - อาจทำให้เกิดไฟฟ้าช็อต หรือไฟไหม้เนื่องจากไฟฟ้าลัดวงจรได้
-  อย่าเปิดอุปกรณ์ทิ้งไว้แล้วออกไปที่อื่น
  - เนื่องจากอาจทำให้เกิดเพลิงไหม้ได้
-  อย่าเก็บอุปกรณ์ไว้ในห้องน้ำ หรือไว้ในที่มีความชื้นสูง และ  
อย่าวางอุปกรณ์ไว้ในที่ที่อาจมีน้ำหกได้ (เช่น บนโต๊ะเครื่องแป้ง)
  - อาจทำให้เกิดไฟฟ้าช็อต หรือไฟไหม้ได้
-  อย่าปิด สอดก๊ีบ หรือสิ่งแปลกปลอมเข้าไปในช่องอากาศเข้า  
ช่องอากาศออก หรือช่องปล่อยไอออน
  - อาจก่อให้เกิดไฟไหม้ ไฟฟ้าช็อต หรือไฟลวกได้
-  ห้ามใช้อุปกรณ์ในบริเวณใกล้เคียงกับวัสดุที่ติดไฟได้ (เช่น  
แอลกอฮอล์ น้ำมันเบนซิน ทินเนอร์ สเปร์ย ผลิตภัณฑ์ดูแลผม  
น้ำยาล้างเล็บ)
  - อาจก่อให้เกิดการระเบิด หรือไฟไหม้ได้
-  อุปกรณ์ที่ไม่ได้ออกแบบให้ใช้งานในเชิงพาณิชย์ และไม่เหมาะที่จะ  
ใช้งานโดยไม่ดูแลรักษาอย่างถูกต้อง
  - อาจทำให้เกิดผลไหม้ หรือไฟไหม้เนื่องจากการใช้งานต่อเนื่องหรือ  
ใช้งานมากเกินไป

-  อย่าจุ่มอุปกรณ์ให้ในน้ำ
-  อย่าใช้อุปกรณ์ให้ใกล้กับน้ำ
-  อย่าใช้อุปกรณ์ให้ใกล้อ่างอาบน้ำ ฝักบัว อ่างล้างหน้า หรือภาชนะ  
บรรจุน้ำอื่น ๆ
  - การทำเช่นนั้น อาจทำให้เกิดไฟฟ้าช็อต หรือไฟไหม้ได้



สัญลักษณ์บนอุปกรณ์หมายถึง “อย่าใช้อุปกรณ์ให้ใกล้กับน้ำ”

หยุดการใช้งานทันทีและถอดปลั๊กออก หากพบว่าอุปกรณ์มีการใช้  
งานที่ผิดปกติหรือไม่ทำงาน

- การไม่ปฏิบัติตามเช่นนั้น อาจก่อให้เกิดไฟไหม้ ไฟฟ้าช็อต หรือได้รับ  
บาดเจ็บได้



<กรณีที่อุปกรณ์ใช้งานผิดปกติ หรือไม่ทำงาน>

- ไม่มีลมออกมา
- ตัวเครื่องหยุดการทำงานเป็นช่วง ๆ
- ภายในตัวเครื่องร้อนมาก และมีควันลอยออกมา
- ติดต่อเพื่อขอตรวจสอบ หรือซ่อมแซมที่ศูนย์บริการที่ได้รับอนุญาตทันที

ใช้เต้ารับไฟภายในบ้านเพียงอย่างเดียว: อย่าย้ายสายไฟพ่วง  
เสียบปลั๊กให้แน่น



ตรวจสอบให้แน่ใจว่า อุปกรณ์ทำงานจากแหล่งจ่ายไฟฟ้าที่ตรงกับ  
อัตราแรงดันไฟฟ้าที่ระบุไว้บนตัวอุปกรณ์

- การไม่ปฏิบัติตามเช่นนั้น อาจก่อให้เกิดไฟไหม้ หรือไฟฟ้าช็อตได้





เมื่อคุณเห็นประกายไฟรอบ ๆ ช่องอากาศออกในขณะที่ใช้ลมร้อน  
ให้หยุดการใช้งาน และนำเส้นใยออกจากช่องอากาศออกและ

ช่องอากาศเข้า

- การไม่ปฏิบัติตามเช่นนั้น อาจก่อให้เกิดบาดเจ็บจากไฟลวกหรือไฟไหม้ได้

## ⚠ คำเตือน

- 

ปิดสวิตช์เปิดปิดและถอดปลั๊กออกจากเต้ารับไฟภายในบ้าน  
หลังการใช้งานเสมอ  
- มิฉะนั้น อาจก่อให้เกิดไฟไหม้ หรือไฟลวกได้
- 

ถอดปลั๊กโดยการจับที่ตัวปลั๊ก แทนการดึงที่สายไฟ  
- มิฉะนั้น อาจทำให้เส้นลวดภายในสายไฟขาดและอาจทำให้เกิดแผลไหม้  
ไฟฟ้ายืด หรือไฟไหม้เนื่องจากไฟฟ้าลัดวงจรได้
- 

ทำความสะอาดปลั๊กอย่างสม่ำเสมอเพื่อป้องกันฝุ่นผงสะสม  
- มิฉะนั้น อาจทำให้เกิดไฟไหม้เนื่องจากฉนวนใช้งานไม่ได้เนื่องจาก  
ความชื้น  
ถอดปลั๊กและเช็ดด้วยผ้าแห้ง
- 

เมื่อใช้เครื่องเป่าผมในห้องน้ำ ให้ถอดปลั๊กออกหลังจากใช้งาน  
เพราะบริเวณที่ใกล้น้ำอาจเป็นอันตราย แม้จะปิดสวิตช์เครื่องแล้ว  
- มิฉะนั้น อาจทำให้เกิดอุบัติเหตุหรือการบาดเจ็บได้
- 

เพื่อเพิ่มการป้องกัน ขอแนะนำให้ติดตั้งอุปกรณ์ป้องกันไฟดูด-รั่ว  
(RCD) ที่มีค่ากระแสไฟฟ้ารั่วตามกำหนดไม่เกิน 30 มิลลิแอมแปร์  
สำหรับวงจรไฟฟ้าที่ใช้ในห้องน้ำ หรือทดสอบสอบถามคำแนะนำจาก  
ผู้ติดตั้ง  
- มิฉะนั้น อาจทำให้เกิดอุบัติเหตุ หรือการบาดเจ็บได้

อุปกรณ์นี้ไม่ได้ผลิตขึ้นมาสำหรับบุคคล (รวมถึงเด็ก ๆ) ที่มีร่างกาย  
ประสาทรับความรู้สึก หรือสภาพทางจิตใจบกพร่อง หรือขาด  
ประสบการณ์และความรู้ เว้นแต่จะได้รับการดูแลหรือคำแนะนำ  
เกี่ยวกับการใช้งานอุปกรณ์นี้โดยผู้ที่ดูแลความปลอดภัยของ  
พวกเขา



ควรดูแลไม่ให้เด็กนำอุปกรณ์นี้มาเล่น  
- การไม่ปฏิบัติตามเช่นนั้น อาจทำให้เกิดอุบัติเหตุ หรือการบาดเจ็บได้



หากสายไฟที่ไหม้ชำรุด ต้องนำไปเปลี่ยนกับผู้ผลิต ศูนย์บริการ  
หรือผู้ให้บริการลักษณะเดียวกันเพื่อป้องกันการเกิดอันตราย  
- การไม่ปฏิบัติตามเช่นนั้น อาจทำให้เกิดอุบัติเหตุ หรือการบาดเจ็บได้



## ⚠ ข้อควรระวัง



อย่าเก็บสายไฟโดยการม้วนหรือบิด  
- อาจทำให้เส้นลวดภายในสายไฟขาดและอาจทำให้เกิดไฟฟ้ายืด หรือ  
ไฟไหม้เนื่องจากไฟฟ้าลัดวงจรได้



อย่าตัดกรง หรือทำให้ได้รับแรงกระแทก  
- อาจทำให้เกิดไฟฟ้ายืด หรือเกิดประกายไฟได้



อย่าใช้งานหากช่องอากาศเข้าได้รับความเสียหาย  
- เส้นผมของคุณอาจติดอยู่ในช่องอากาศเข้า ซึ่งอาจก่อให้เกิดความ  
เสียหายต่อเส้นผมได้



ห้ามสัมผัสช่องอากาศออกและชุดหัวเป่าซึ่งจะมีอุณหภูมิสูงขึ้นมา  
- การทำเช่นนั้น อาจก่อให้เกิดไฟลวกได้



อย่าใช้อุปกรณ์นี้กับทารก  
- การทำเช่นนั้น อาจก่อให้เกิดไฟลวกได้

## ⚠️ ข้อควรระวัง

ในขณะที่ตั้งหรือพับด้ามจับ อย่าสัมผัสบริเวณที่แรงตามที่ปรากฏ  
ในรูปภาพที่แสดงไว้ด้านล่าง

- เนื่องจากอาจก่อให้เกิดการบาดเจ็บที่นิ้วมือได้

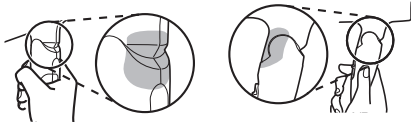

อย่ามองที่ช่องอากาศออกขณะใช้งาน

- เครื่องเป่าผมอาจเป่าเอาฝุ่น ฯลฯ ซึ่งอาจทำให้เกิดการบาดเจ็บได้



โปรดรักษาระยะห่างมากกว่า 3 ซม.

ระหว่างช่องอากาศออกและเส้นผม

- การไม่ปฏิบัติตามดังกล่าวอาจทำให้เส้นผมไหม้ได้

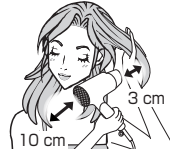

ควรให้เส้นผมของคุณอยู่ห่างจาก

ช่องอากาศเข้าอย่างน้อย 10 ซม.



- เส้นผมของคุณอาจเข้าไปพันในช่องอากาศ  
เข้า ซึ่งอาจก่อให้เกิดความเสียหายต่อเส้นผม  
ได้



ใช้สำหรับการเป่าผมหรือการจัดแต่งทรงผมเท่านั้น (อย่าใช้เครื่อง  
เป่าผมกับสัตว์เลี้ยง หรือเสื้อผ้า รองเท้า ฯลฯ)

- การไม่ปฏิบัติตามเช่นนั้น อาจก่อให้เกิดไฟไหม้ หรือไฟลวกได้

## ►หมายเหตุ

- อุปกรณ์นี้มีอุปกรณ์ตัดไฟอัตโนมัติเพื่อป้องกันความร้อนที่สูงเกินไป หากอุปกรณ์  
เกิดความร้อนที่สูงเกินไป เครื่องจะสับสวิตช์ไปเป็นระบบเป่าลมเย็น ให้เปิด  
สวิตช์อุปกรณ์และถอดปลั๊กออกจากเต้ารับไฟภายในบ้าน ปลดปล่อยให้เครื่อง  
เป่าลมเย็นลงประมาณ 2 - 3 นาที แล้วจึงเริ่มใช้งานอีกครั้ง ตรวจสอบว่าไม่มี  
ฝุ่นผง เส้นผม หรืออื่น ๆ ติดอยู่ที่ช่องอากาศเข้าและช่องอากาศออกก่อนที่จะ  
เปิดสวิตช์อีกครั้ง

## ส่วนต่าง ๆ ของอุปกรณ์

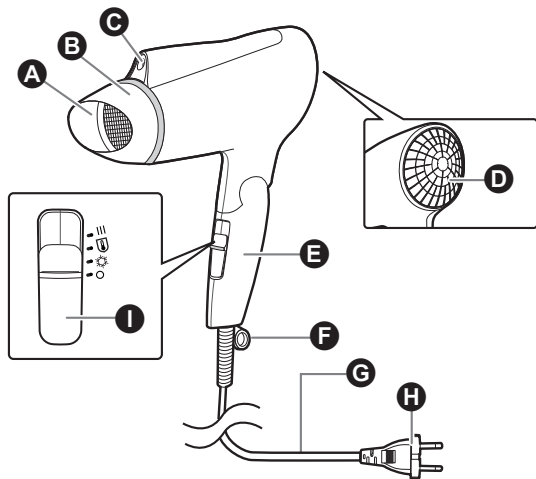

- A ช่องอากาศออก
- B ชุดหัวเป่า
- C ช่องปล่อยไอออน **EH-NE20 เท่านั้น**
- D ช่องอากาศเข้า
- E คัมจับ
- F ห่วงสำหรับแชน
- G สายไฟ
- H ปลั๊ก

รูปทรงของปลั๊กอาจแตกต่างกันในแต่ละพื้นที่

### I สวิตช์เปิดปิด

- III เทอร์โบ (ลมร้อนแบบแรง)
- ☀ ฮีท โปรดักชั่น (ลมอุ่นแบบแรง)
- ☀ ลมเย็นแรง (ลมเย็นแบบแรง)
- ปิด

(คำแนะนำบางอย่างจะใช้ภาพประกอบคำอธิบายผลิตภัณฑ์เป็นรุ่น EH-NE20)

## วิธีใช้เครื่องเป่าผม

**1** ก่อนการใช้งานเครื่องเป่าผม ตรวจสอบให้แน่ใจว่าสวิตช์เปิดปิดอยู่ที่ตำแหน่ง “O” แล้วจึงเสียบปลั๊กเข้ากับเต้ารับไฟภายในบ้านและเปิดสวิตช์เปิดปิด

**2** เลือกระดับความแรงของลมด้วยสวิตช์เปิดปิด แล้วเป่าผมให้แห้ง

**3** ปรับสวิตช์เปิดปิดไปที่ตำแหน่ง “O” แล้วถอดปลั๊กออกจากเต้ารับ

### ▶ ชุดหัวเป่า

หากต้องการจัดแต่งทรงผมให้ง่ายขึ้นและผมแห้งเร็วขึ้น ให้ประกอบชุดหัวเป่าเข้ากับเครื่องเป่าผม

- ชุดหัวเป่าจะช่วยให้ลมเป่าไปยังส่วนของเส้นผมที่ต้องการโดยตรง

## ไอออน (EH-NE20 เท่านั้น)

ไอออน คือ อนุภาคที่รวมออกซิเจนที่เป็นประจุลบกับความชุ่มชื้นในอากาศ และไม่สามารถมองเห็นได้ด้วยตาเปล่า

(กระบวนการสร้างไอออน: การปล่อยประจุที่มีแรงดันไฟฟ้าสูง)

### ▶หมายเหตุ

- อาจมีกลิ่นแปลกๆ ขณะใช้เครื่องเป่าผมนี้ ทั้งนี้ไม่เป็นอันตรายต่อร่างกาย
- บุคคลตั้งต่าไปนี้เมื่อใช้ไอออนแล้วอาจไม่เกิดผล ผู้ที่มีผมดัดเป็นลอน ผมหยิกมาก ผมสั้นมาก ผมสั้น หรือผู้ที่ยึดผมมาภายในสามหรือสี่เดือน

## อีท โพรเทคชั่น

โหมดนี้จะช่วยให้เครื่องมีอุณหภูมิที่อุ่นคงที่เพื่อช่วยปกป้องเส้นผมและหนังศีรษะจากความร้อน

## การบำรุงรักษาเครื่องเป่าผม

ตรวจสอบว่าได้ปิดสวิตช์เปิดและถอดปลั๊กออกจากเต้ารับไฟภายในบ้าน หลังการใช้งานเสมอ (เว้นแต่ขณะที่ทำการบำรุงรักษาของอากาศออก)

### การบำรุงรักษาเครื่องเป่าผม

ทำความสะอาดตัวเครื่องเมื่อเครื่องเป่าผมสกปรก

ทำความสะอาดตัวเครื่องด้วยผ้าที่ชุบน้ำหรือน้ำผสมสบู่พอหมาด ๆ

#### ► หมายเหตุ

- ห้ามใช้แอลกอฮอล์ สารขัด หรือสบู (สบู่เหลว หรืออื่น ๆ)
  - การทำเช่นนั้น อาจทำให้เครื่องทำงานผิดปกติ ชิ้นส่วนแตกร้าว/เปลี่ยนสี เป็นต้น
- การปล่อยให้เครื่องเป่าผมยังคงมีผลิตภัณฑ์ที่ใช้กับเส้นผมหรือเครื่องสำอาง ติดอยู่กับตัวเครื่อง อาจทำให้พลาสติกเสื่อมสภาพเป็นผลทำให้ บริเวณดังกล่าวเปลี่ยนสีหรือแตกร้าว และทำงานผิดปกติได้

### การบำรุงรักษาช่องอากาศเข้า

ทำความสะอาดช่องอากาศเข้าอย่างน้อยเดือนละหนึ่งครั้ง

- เช็ดเส้นใย เส้นผม หรือสิ่งอื่น ๆ ออกจากช่องอากาศเข้าโดยใช้กระดาษทิชชู หรือแปรงสีฟัน

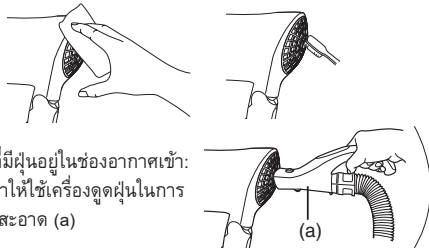

(ในกรณีที่ไม่มีฝุ่นอยู่ในช่องอากาศเข้า: ขอแนะนำให้ใช้เครื่องดูดฝุ่นในการทำความสะอาด (a))

#### ► หมายเหตุ

- อย่ากดหรือถูช่องอากาศเข้าด้วยเล็บหรือวัตถุปลายแหลมอื่น ๆ
  - การทำเช่นนั้น อาจทำความเสียหายต่อช่องอากาศเข้า

## การบำรุงรักษาช่องอากาศออก

ทำความสะอาดช่องอากาศออกอย่างน้อยเดือนละหนึ่งครั้ง

ดูเพื่อขจัดฝุ่น เส้นผม ฯลฯ ที่ติดอยู่กับตะแกรง

- ควรเสียบปลั๊กเครื่องเป่าผมเข้ากับเต้ารับไฟภายในบ้านในกรณีที่ทำการบำรุงรักษาช่องอากาศออกเท่านั้น
- ปรับสวิตช์เปิดปิดไปที่ “” แล้วใช้ลมเย็นเป่าฝุ่น ฯลฯ ออกไปขณะใช้แปรงสีฟันขัดดู

#### ► หมายเหตุ

- ในระหว่างการบำรุงรักษา อย่าให้มือของท่านหรือสิ่งอื่น ๆ กีดขวางช่องอากาศเข้า
- หลังจากการบำรุงรักษาช่องอากาศออก ฝุ่นหรือสิ่งอื่น ๆ อาจกระจายออกมา ต้องแน่ใจว่าเครื่องเป่าผมหยุดเอาฝุ่นหรือสิ่งอื่น ๆ ออกจากช่องอากาศออกแล้วก่อนที่จะเริ่มใช้งานอีกครั้ง (อย่ามองที่ช่องอากาศออก)

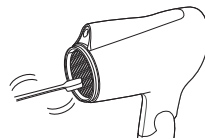

(ใช้แปรงสีฟันที่มีจำหน่ายทั่วไป)

## การบำรุงรักษาช่องปล่อยไอออน (EH-NE20 เท่านั้น)

ทำความสะอาดช่องปล่อยไอออนทุก ๆ 6 เดือน

การบำรุงรักษานี้จะช่วยให้เครื่องเป่าผมรักษาระดับของการสร้างไอออนได้เป็นเวลานาน

- ใช้ก้านสำลิตีที่หาซื้อได้ทั่วไป (ขอแนะนำให้ใช้ก้านสำลิตีขนาดเล็กที่ใช้สำหรับทารก)
- ค่อย ๆ สอดก้านสำลิตีเข้าไปจนสุด (ประมาณ 6 มม.) แล้วหมุนเบา ๆ 2 หรือ 3 ครั้ง





## วิธีการแก้ปัญหาเครื่องเป่าผม

ปัญหา	สาเหตุที่เป็นไปได้	การแก้ไข
เครื่องสลับเป็นลมเย็นบ่อยๆ เมื่อใช้ในโหมด "ร้อน" หรือมองเห็นประกายไฟในตัวเครื่อง (ประกายไฟอาจมีสาเหตุมาจากสวิตช์ควบคุมอุณหภูมิอุปกรณ์ป้องกันเครื่อง และไม่เป็นอันตราย)	▶ มีเส้นใยสะสมในช่องอากาศเข้าหรือช่องอากาศออก ▶ มีเส้นผมหรือสิ่งอื่นอุดตันในช่องอากาศเข้า	▶ นำเส้นใยที่สะสมอยู่ออก ▶ อย่าปิดช่องอากาศเข้า
ลมร้อนเปลี่ยนเป็นลมเย็นซ้ำไปซ้ำมา	▶	
ลมร้อนผิดปกติ	▶	
ปลั๊กไฟร้อนผิดปกติ	▶ ปลั๊กไฟเชื่อมต่อกับเต้ารับไฟภายในบ้านไม่แน่น	▶ ใช้เต้ารับไฟภายในบ้านที่มีขนาดพอดี
มีประกายไฟเกิดขึ้นภายในช่องปลั๊กไอออน (EH-NE20 เท่านั้น)	▶	
ช่องปลั๊กไอออนมีเสียงดัง (เสียงแตกหัก) (EH-NE20 เท่านั้น)	▶ ความผิดปกติอาจเกิดจากความสกปรกของ ▶ อิเล็กโทรด (ส่วนเข็ม)	▶ ทำการบำรุงรักษาช่องปลั๊กไอออน

หากปัญหาเหล่านี้ยังคงไม่สามารถแก้ไขได้ ติดต่อร้านค้าที่คุณซื้อเครื่องเป่าผมนี้ หรือศูนย์บริการที่ได้รับอนุญาตจาก Panasonic เพื่อทำการซ่อมแซม

## ข้อมูลทางเทคนิคสินค้า

ชื่อผลิตภัณฑ์	เครื่องเป่าผม		
รุ่นผลิตภัณฑ์	EH-NE20, EH-ND30		
แหล่งไฟฟ้า	220 V ~ 50 - 60 Hz	230 V ~ 50 - 60 Hz	240 V ~ 50 - 60 Hz
การใช้ไฟ	1 500 W	1 650 W	1 800 W
อุปกรณ์เสริม	ชุดหัวเป่า		

สินค้าสำหรับใช้ในบ้าน

# MEMO



1841

# Panasonic

Hướng dẫn sử dụng  
(Gia dụng) Máy sấy tóc

Mẫu máy EH-NE20  
EH-ND30

## Mục lục

<b>Các lưu ý về an toàn .....</b>	<b>44</b>	<b>Giới thiệu về bảo vệ nhiệt .....</b>	<b>49</b>
<b>Nhận biết các bộ phận .....</b>	<b>48</b>	<b>Bảo trì máy sấy tóc.....</b>	<b>50</b>
<b>Cách sử dụng máy sấy tóc.....</b>	<b>49</b>	<b>Xử lý sự cố.....</b>	<b>51</b>
<b>Giới thiệu về ion (Chỉ dành cho EH-NE20) .....</b>	<b>49</b>	<b>Các thông số kỹ thuật.....</b>	<b>51</b>

Cảm ơn bạn đã mua sản phẩm Máy sấy tóc của Panasonic.  
Trước khi vận hành thiết bị, xin vui lòng đọc toàn bộ hướng dẫn sử dụng và lưu lại tham khảo về sau.

## Các lưu ý về an toàn

Để giảm nguy cơ chấn thương, thiệt mạng, giật điện, hỏa hoạn và hư hỏng cho tài sản, luôn luôn tuân thủ các biện pháp phòng ngừa an toàn sau đây.

### Giải thích các biểu tượng

Các biểu tượng sau đây được sử dụng để phân loại và mô tả các mức độ nguy hiểm, chấn thương và hư hỏng tài sản gây ra bởi việc bỏ qua các dấu hiệu đó và sử dụng không đúng quy định.



## CẢNH BÁO

Biểu hiện mỗi nguy hiểm tiềm ẩn có thể dẫn đến thương tích nghiêm trọng hoặc tử vong.



## THẬN TRỌNG

Biểu hiện mỗi nguy hiểm có thể dẫn đến tổn thương nhẹ hoặc thiệt hại về tài sản.

Các biểu tượng sau đây được sử dụng để phân loại và mô tả các loại hướng dẫn cần được tuân thủ.



Biểu tượng này được sử dụng để cảnh báo người dùng về một thao tác cụ thể không được phép thực hiện.



Biểu tượng này được sử dụng để cảnh báo người dùng về một thao tác cụ thể nên làm theo nhằm vận hành thiết bị an toàn.

Hình minh họa trong "Biện pháp phòng ngừa an toàn" có thể khác với sản phẩm thực tế.



## CẢNH BÁO

**Không bảo quản trong tầm với của trẻ em hoặc trẻ sơ sinh. Không được để cho trẻ sử dụng máy.**



- Làm như vậy có thể gây bỏng, giật điện, hoặc chấn thương.

**Không bao giờ được thay đổi, tháo rời, hoặc sửa chữa.**



- Làm như vậy có thể gây ra cháy hoặc chấn thương do việc vận hành bất thường.  
Xin liên hệ với một trung tâm dịch vụ được ủy quyền để sửa chữa.

**Không được làm hư hỏng hoặc sửa đổi, dùng lực uốn cong, kéo, hoặc xoắn dây điện. Ngoài ra, không được đặt bất cứ vật gì nặng lên trên hoặc kẹp dây điện.**



- Làm như vậy có thể gây điện giật hoặc cháy do chập điện.

**Không được sử dụng khi dây điện đang bị bó lại.**



- Làm như vậy có thể gây ra hỏa hoạn hoặc điện giật.

**Không được quấn dây điện xung quanh thân máy khi cất giữ.**



- Làm như vậy có thể khiến lõi dây bên trong dây điện bị gãy do tải trọng, và có thể gây điện giật hoặc cháy do chập điện.

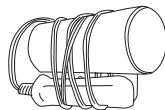

**Không được sử dụng khi phích cắm hoặc dây điện bị hỏng hoặc đang nóng.**



- Làm như vậy có thể gây ra bỏng, điện giật hoặc cháy do chập điện.



## CẢNH BÁO



**Không được sử dụng thiết bị này nếu phích cắm cắm lỏng vào ổ cắm điện tại nhà.**

- Làm như vậy có thể gây ra bỏng, điện giật hoặc cháy do chập điện.



**Không được cắm hoặc rút phích cắm khỏi ổ cắm điện nhà khi tay đang ướt.**

- Làm như vậy có thể gây ra giật điện hoặc chấn thương.



**Không được sử dụng thiết bị khi tay đang ướt.**

- Làm như vậy có thể gây điện giật hoặc cháy do chập điện.



**Không được bỏ đi khi công tắc nguồn vẫn được bật.**

- Làm như vậy có thể gây ra cháy.



**Không được cất thiết bị trong phòng tắm hoặc nơi có độ ẩm cao. Và, không được đặt máy ở nơi nước có thể tràn vào (chẳng hạn như bên trên bộ trong phòng tắm).**

- Làm như vậy có thể gây ra điện giật hoặc cháy.



**Không được bit chặn hoặc đưa ghim kẹp tóc hay các ngoại vật khác vào công hút khí, miệng thổi gió hoặc đầu phun ion.**

- Làm như vậy có thể gây ra cháy, điện giật hoặc bỏng.



**Không được sử dụng gần các vật liệu dễ cháy (chẳng hạn như rượu, ét-xăng, chất pha loãng, chai xịt, sản phẩm dưỡng tóc, chai tẩy sơn móng tay).**

- Làm như vậy có thể gây ra cháy nổ.



**Thiết bị này không được thiết kế cho mục đích sử dụng thương mại và không được dùng nếu không bảo trì thích hợp.**

- Làm như vậy có thể gây cháy hoặc hỏa hoạn do tình trạng tải liên tục hoặc quá tải.



**Không được dim thiết bị này vào nước.**

**Không được sử dụng thiết bị này gần nước.**

**Không sử dụng thiết bị này gần bồn tắm, vòi hoa sen, chậu rửa hoặc các thùng đựng nước khác.**

- Làm như vậy có thể gây ra điện giật hoặc cháy.



**Biểu tượng này trên thiết bị có nghĩa là “Không được sử dụng thiết bị này gần nước”.**

**Ngừng sử dụng ngay lập tức và rút phích cắm nếu có hiện tượng bất thường hay hư hỏng.**

- Không làm như vậy có thể gây cháy, giật điện, hoặc chấn thương.



**<Các trường hợp bất thường hay hư hỏng>**

• Máy không thổi gió

• Máy thỉnh thoảng dừng lại

• Phần bên trong trở nên nóng đỏ và phát ra khói

- Ngay lập tức yêu cầu kiểm tra hoặc sửa chữa tại một trung tâm dịch vụ được ủy quyền.

**Chỉ sử dụng với ổ cắm điện: Không được sử dụng với dây điện nối dài.**

**Cắm thật chặt phích cắm.**



**Luôn luôn đảm bảo thiết bị vận hành với nguồn điện đúng với điện áp định mức được chỉ báo trên thiết bị.**

- Không làm như vậy có thể gây ra cháy hoặc điện giật.



**Khi bạn nhìn thấy các tia lửa điện xung quanh miệng thổi gió khi sử dụng cài đặt khí nóng, hãy ngừng sử dụng và gỡ bỏ xơ vãi trên miệng thổi gió và công hút khí.**

- Không làm như vậy có thể gây ra bỏng hoặc cháy.



## CẢNH BÁO



**Luôn luôn TẮT công tắc nguồn và rút phích cắm ra khỏi ổ cắm điện nhà sau khi dùng xong.**

- Không làm như vậy có thể gây ra cháy hoặc bỏng.



**Rút phích cắm bằng cách nắm giữ và rút phích ra, thay vì kéo dây điện.**

- Không làm như vậy có thể khiến lõi dây bên trong dây điện bị đứt và có thể gây bỏng, điện giật hoặc cháy do chập điện.



**Vệ sinh phích cắm thường xuyên để ngăn ngừa bụi bám tích tụ.**

- Không làm như vậy có thể gây ra cháy do độ ẩm làm hỏng lớp cách nhiệt.

Rút phích cắm và lau sạch bằng vải khô.



**Khi sử dụng thiết bị trong phòng tắm, hãy rút phích cắm sau khi sử dụng vì thiết bị ở gần nước có thể gây ra nguy hiểm ngay cả khi đã tắt nguồn thiết bị.**

- Không làm như vậy có thể gây tai nạn hoặc chấn thương.



**Để tăng thêm sự bảo vệ, nên lắp đặt thiết bị chống giật (thiết bị RCD) để mạch điện hoạt động cung cấp trong phòng tắm không vượt quá 30 mA. Tham khảo ý kiến với người lắp đặt.**

- Không làm như vậy có thể gây tai nạn hoặc chấn thương.



Thiết bị này không dành sử dụng cho những người (kể cả trẻ nhỏ) không đủ điều kiện tiêu chuẩn thể chất, tinh thần, hay thiếu hiểu biết và kinh nghiệm, trừ khi họ được trợ giúp hoặc được hướng dẫn về việc sử dụng máy sấy bởi người có trách nhiệm về sự an toàn của họ.

**Nên trông nom trẻ em cẩn thận để chúng không dùng máy sấy để chơi đùa.**

- Không làm như vậy có thể gây tai nạn hoặc chấn thương.



**Nếu dây nguồn bị hỏng thì phải do nhà sản xuất, đại lý dịch vụ hoặc những nhân viên có đủ tiêu chuẩn thay thế để tránh gặp rủi ro.**

- Không làm như vậy có thể gây tai nạn hoặc chấn thương.



## THẬN TRỌNG



**Không được cắt giữ dây điện bằng cách quấn bó lại.**

- Làm như vậy có thể khiến lõi dây bên trong dây điện bị gãy do tải trọng, và có thể gây điện giật hoặc cháy do chập điện.



**Không được làm rơi hoặc va chạm máy.**

- Làm như vậy có thể gây ra giật điện hoặc phát lửa.



**Không được sử dụng khi công hút khí đang bị hư hỏng.**

- Tóc bạn có thể bị mắc vào công hút khí, khiến tóc có thể hỏng.



**Không được chạm vào miệng thổi gió và đầu sấy tập trung vì những bộ phận này sẽ trở nên rất nóng.**

- Làm như vậy có thể gây ra bỏng.



**Không được sử dụng cho trẻ sơ sinh.**

- Làm như vậy có thể gây ra bỏng.



# THẬN TRỌNG

**Khi mở ra hoặc gấp tay cầm, không được chạm vào các chỗ bóng mờ như minh họa trong hình dưới đây.**

- Làm như vậy có thể gây ra chấn thương.

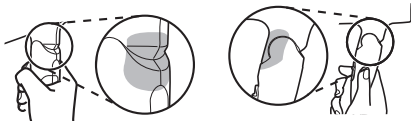

**Không nhìn vào miệng thổi gió trong khi sử dụng.**

- Máy sấy tóc thổi khí kèm với bụi có thể gây chấn thương.



**Đảm bảo giữ khoảng cách trên 3 cm giữa miệng thổi gió và tóc của bạn.**

- Không làm như vậy có thể làm cho tóc của bạn bị đốt cháy.

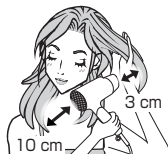

**Hãy nhớ giữ tóc của bạn cách xa cổng hút khí tối thiểu 10 cm.**

- Tóc bạn có thể bị mắc vào cổng hút khí, gây hỏng tóc.



**Chỉ sử dụng để sấy khô hoặc tạo kiểu tóc cho người. (Không được sử dụng cho vật nuôi, hoặc sấy khô quần áo, giày dép, v.v...)**

- Không làm như vậy có thể gây ra cháy hoặc bỏng.



## ► Ghi chú

- Thiết bị này được trang bị bộ phận bảo vệ chống quá nóng tự động. Nếu quá nóng, thiết bị sẽ chuyển sang chế độ phá khí mát. Tắt thiết bị và rút phích cắm ra khỏi ổ cắm điện nhà. Để máy nguội trong vài phút rồi mới sử dụng lại. Kiểm tra để đảm bảo là trong cổng hút khí và miệng thổi gió không có bụi, tóc, v.v. trước khi bật lại máy.

## Nhận biết các bộ phận

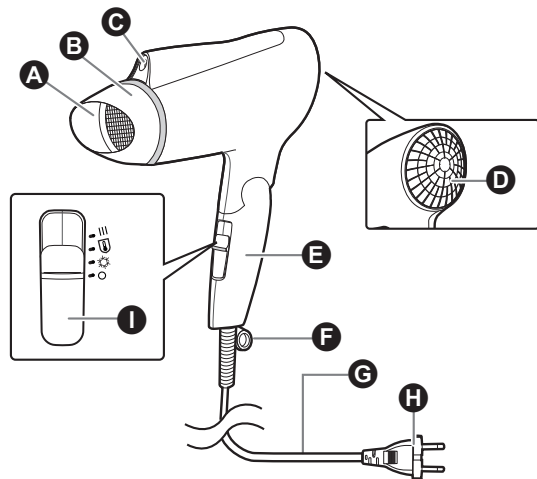

**A** Miệng thổi gió

**B** Đầu sấy tập trung

**C** Đầu phun ion Chỉ dành cho EH-NE20

**D** Cổng hút khí

**E** Tay cầm

**F** Vòng treo

**G** Dây điện

**H** Phích cắm

Hình dạng phích cắm sẽ thay đổi tùy theo khu vực.

**I** Công tắc nguồn

III Turbo  
(Luồng khí nóng phả mạnh)

U Bảo vệ nhiệt  
(Luồng khí ấm phả mạnh)

☀ Khí mát phả mạnh  
(Luồng khí mát phả mạnh)

○ Tắt

(Một số hướng dẫn chỉ sử dụng hình minh họa của mẫu EH-NE20 để giải thích sản phẩm.)



## Cách sử dụng máy sấy tóc

- 1** Trước khi sử dụng máy sấy tóc, hãy bảo đảm rằng công tắc nguồn ở vị trí “O”, sau đó cắm phích vào ổ cắm điện nhà và bật công tắc nguồn.
- 2** Chọn cường độ của luồng khí bằng công tắc nguồn, rồi sấy khô tóc.
- 3** Chuyển công tắc nguồn sang vị trí “O”, rồi rút phích cắm khỏi ổ cắm điện tại nhà.

### ► Đầu sấy tập trung

Để dễ dàng tạo kiểu và sấy khô tóc, gắn đầu sấy tập trung vào máy sấy tóc.

- Đầu sấy tập trung giúp hướng luồng khí vào một vùng tóc cụ thể.

## Giới thiệu về ion (Chỉ dành cho EH-NE20)

Ion là các phân tử kết hợp ôxy mang điện tích âm với độ ẩm trong không khí và mắt thường không thể nhìn thấy được. (Phương pháp tạo ion: Phóng điện áp cao)

### ► Ghi chú

- Bạn có thể thấy mùi đặc trưng khi sử dụng máy sấy tóc này. Mùi này không gây hại cho cơ thể người.
- Những người sau đây có thể không cảm nhận được tác dụng của ion.  
Người có tóc xoăn tự nhiên, tóc xoăn tít, tóc rất thẳng, tóc ngắn hoặc người làm tóc thẳng trong 3 hoặc 4 tháng gần đây nhất.

## Giới thiệu về bảo vệ nhiệt

Chế độ này cung cấp nhiệt độ ấm và ổn định để bảo vệ tóc và da đầu khỏi bị nóng.

## Bảo trì máy sấy tóc

Bảo đảm rằng bạn đã TẮT công tắc nguồn và rút phích cắm ra khỏi ổ cắm điện nhà. (Ngoại trừ khi thực hiện việc bảo trì cho miệng thổi gió)

### Bảo trì máy sấy tóc

Lau sạch phần thân máy khi máy sấy tóc bị bẩn. Chỉ được vệ sinh phần vỏ máy bằng một miếng vải mềm hơi ẩm với nước máy hoặc nước máy pha xà phòng.

#### ► Ghi chú

- Không sử dụng cồn, chất tẩy rửa móng hoặc chất tẩy rửa (xà phòng rửa tay dạng lỏng, v.v).
- Làm như vậy có thể gây ra sự cố, nứt/phai màu các bộ phận v.v...
- Nếu để máy sấy tóc bị các sản phẩm dùng cho tóc hoặc trang điểm dính vào tay cầm hoặc thân máy thì có thể làm xuống cấp phần nhựa, gây phai màu hoặc nứt nẻ và làm máy hư hỏng.

### Bảo trì cổng hút khí

Lau sạch cổng hút khí tối thiểu mỗi tháng một lần.

- Lau để loại bỏ xơ vải, tóc hoặc các vật khác khỏi cổng hút khí bằng khăn giấy hoặc bàn chải đánh răng.

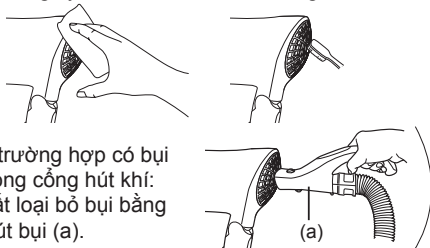

(Trong trường hợp có bụi bên trong cổng hút khí: Đề xuất loại bỏ bụi bằng máy hút bụi (a).)

#### ► Ghi chú

- Không ấn hoặc chà cổng hút khí bằng móng tay hoặc vật nhọn khác.
- Làm như vậy có thể làm hỏng cổng hút khí.

## Bảo trì miệng thổi gió

Lau sạch miệng thổi gió tối thiểu mỗi tháng một lần. Chà nhẹ để loại bỏ bụi, tóc, v.v... chặn mắt lưới.

- Máy sấy tóc này nên được cắm vào ổ điện nhà chỉ trong trường hợp bảo trì miệng thổi gió.
- Chuyển công tắc nguồn sang vị trí “” và dùng luồng khí mát để thổi sạch bụi hoặc các vật khác đi khi bạn chà nhẹ bằng bàn chải đánh răng.

#### ► Ghi chú

- Trong quá trình bảo trì, không được chặn cổng hút khí bằng tay v.v...
- Trong hoặc sau khi bảo trì miệng thổi gió, bụi có thể phân tán. Đảm bảo máy sấy tóc không thổi bụi từ miệng thổi gió trước khi sử dụng. (Không nhìn vào miệng thổi gió.)

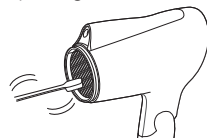

(Sử dụng một bàn chải đánh răng có trên thị trường.)

## Bảo trì đầu phun ion (Chỉ dành cho EH-NE20)

Lau sạch đầu phun ion 6 tháng một lần.

Hoạt động bảo trì này giúp máy sấy tóc duy trì được mức ion đã tạo trong một thời gian dài.

- Sử dụng giẻ lau cotton được bán sẵn. (Nên dùng giẻ lau mỏng bằng cotton được sản xuất để trẻ nhỏ sử dụng.)
- Đưa nhẹ giẻ lau cotton vào cho đến khi dùng lại (khoảng 6 mm) và xoay nhẹ 2 hoặc 3 lần.

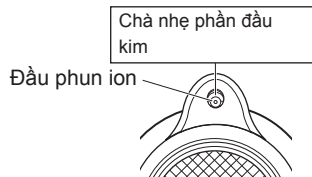

## Xử lý sự cố

Vấn đề	Nguyên nhân có thể	Hành động
Máy thường xuyên chuyển sang không khí mát khi sử dụng ở chế độ "Hot" (không khí nóng), hoặc có thể nhìn thấy tia lửa bên trong thân máy. (Các tia lửa này là do rơ-le nhiệt, thiết bị bảo vệ tạo ra và chúng không gây nguy hiểm.)	▶ Xơ vải đã tích tụ trong cổng hút khí hoặc miệng thổi gió. Tóc hoặc thứ gì đó đang chặn cổng hút khí.	▶ Lau sạch xơ vải tích tụ. Không được bít chặn cổng hút khí.
Khí nóng liên tục chuyển thành khí mát.	▶	
Khí nóng trở nên nóng bất thường.	▶	
Phích cắm trở nên nóng bất thường.	▶ Phích cắm vào ổ cắm điện tại nhà bị lỏng.	▶ Sử dụng ổ cắm điện tại nhà vừa khít một cách an toàn.
Các tia lửa được tạo ra bên trong đầu phun ion. (Chỉ dành cho EH-NE20)	▶	
Đầu phun ion phát ra tiếng ồn (tiếng tanh tách). (Chỉ dành cho EH-NE20)	▶ Hiện tượng bất thường là do điện cực bẩn (phần kim). ▶	▶ Thực hiện bảo trì đầu phun ion.

Nếu vấn đề vẫn không được khắc phục, hãy liên hệ với cửa hàng nơi bạn mua thiết bị đó hoặc với trung tâm dịch vụ được Panasonic ủy quyền để sửa chữa.

## Các thông số kỹ thuật

Tên sản phẩm	Máy sấy tóc		
Mẫu sản phẩm	EH-NE20, EH-ND30		
Nguồn điện	220 V ~ 50 - 60 Hz	230 V ~ 50 - 60 Hz	240 V ~ 50 - 60 Hz
Mức độ tiêu thụ điện	1 500 W	1 650 W	1 800 W
Phụ kiện	Đầu sấy tập trung		

Sản phẩm này chỉ dành để sử dụng trong gia đình.

# MEMO

Tiếng Việt

# Panasonic

## Petunjuk Pengoperasian Pengering Rambut (Rumah Tangga)

Model Nomor **EH-NE20**  
**EH-ND30**

### Konten

---

<b>Tindakan pengamanan .....</b>	<b>54</b>	<b>Tentang pelindung panas .....</b>	<b>59</b>
<b>Identifikasi bagian .....</b>	<b>58</b>	<b>Perawatan pengering rambut.....</b>	<b>60</b>
<b>Cara menggunakan pengering rambut .....</b>	<b>59</b>	<b>Pemecahan masalah .....</b>	<b>61</b>
<b>Tentang ion (khusus EH-NE20) .....</b>	<b>59</b>	<b>Spesifikasi.....</b>	<b>61</b>

Terima kasih telah membeli produk Panasonic ini.

**Sebelum mengoperasikan alat ini, harap baca instruksi secara menyeluruh dan simpanlah untuk penggunaan di masa mendatang.**

## Tindakan pengamanan

Untuk mengurangi risiko cedera, korban jiwa, tersengat listrik, kebakaran, dan kerusakan terhadap harta benda, ambil langkah-langkah berikut untuk keamanan.

### Penjelasan simbol

Simbol-simbol berikut ini digunakan untuk menggolongkan dan menggambarkan tingkat bahaya, cedera, dan kerusakan harta benda yang ditimbulkan ketika petunjuk diabaikan dan alat digunakan secara tidak benar.



## PERINGATAN

Menunjukkan potensi bahaya yang dapat berakibat pada cedera serius atau kematian.



## PERHATIAN

Menunjukkan bahaya yang dapat berakibat pada cedera ringan atau kerusakan harta benda.

Simbol berikut ini digunakan untuk menggolongkan dan menggambarkan jenis instruksi yang harus diikuti.



Simbol ini digunakan untuk memberi tahu pengguna prosedur pengoperasian tertentu yang tidak boleh dilakukan.



Simbol ini digunakan untuk memberi tahu pengguna prosedur pengoperasian tertentu yang harus diikuti untuk mengoperasikan alat ini secara aman.

Ilustrasi dalam “Tindakan pengamanan” dapat berbeda dari produk sebenarnya.



## PERINGATAN



**Jauhkan dari jangkauan anak-anak atau balita. Jangan biarkan mereka menggunakan alat ini.**

- Hal ini dapat menyebabkan luka bakar, sengatan listrik, atau cedera.



**Jangan pernah mengubah, membongkar, atau memperbaiki alat ini.**

- Tindakan semacam itu dapat menyebabkan terpicunya api atau cedera akibat pengoperasian yang tidak normal. Hubungi pusat layanan resmi untuk perbaikan.



**Jangan merusak atau memodifikasi, atau secara paksa membengkokkan, menarik, atau memelintir kabel. Selain itu, jangan menaruh kabel di bawah benda berat atau menjepit kabel.**

- Tindakan tersebut dapat menyebabkan sengatan listrik atau kebakaran karena arus pendek.



**Jangan gunakan apabila kabel dalam kondisi kusut.**

- Tindakan tersebut dapat menyebabkan kebakaran atau kejutan listrik.

**Jangan melilitkan kabel pada bodi utama alat ketika menyimpannya.**





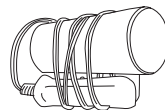





- Tindakan tersebut dapat menyebabkan kawat di dalam kabel patah disertai kebocoran arus, dan dapat menyebabkan sengatan listrik atau kebakaran karena arus pendek.



**Jangan gunakan alat ini apabila steker atau kabel dalam kondisi rusak atau panas.**

- Tindakan tersebut dapat menyebabkan luka bakar, sengatan listrik, atau kebakaran karena arus pendek.

# PERINGATAN

-  **Jangan menggunakan alat ini apabila steker di stopkontak rumah Anda longgar.**
  - Tindakan tersebut dapat menyebabkan luka bakar, sengatan listrik, atau kebakaran karena arus pendek.
-  **Jangan memasang atau mencabut steker dari stopkontak rumah dengan tangan basah.**
  - Tindakan tersebut dapat menyebabkan sengatan listrik atau cedera.
-  **Jangan menggunakan alat dengan tangan basah.**
  - Tindakan tersebut dapat menyebabkan sengatan listrik atau kebakaran karena arus pendek.
-  **Jangan meninggalkan area pemakaian dalam kondisi sakelar daya menyala.**
  - Hal tersebut dapat menyebabkan kebakaran.
-  **Jangan menyimpan alat ini di kamar mandi atau di lokasi dengan kelembapan tinggi. Selain itu, hindari meletakkan alat di lokasi di mana air dapat tumpah lokasi di mana air bisa tumpah (seperti di atas meja rias).**
  - Tindakan tersebut dapat menyebabkan sengatan listrik atau kebakaran.
-  **Jangan menutupi, atau memasukkan jepit rambut atau benda asing lainnya ke dalam lubang udara masuk, lubang udara keluar, atau lubang ion keluar.**
  - Tindakan tersebut dapat menyebabkan kebakaran, sengatan listrik, atau luka bakar.
-  **Jangan gunakan di dekat bahan yang mudah terbakar (seperti alkohol, bensin, tiner, semprotan, produk perawatan rambut, penghapus cat kuku).**
  - Tindakan tersebut dapat menyebabkan ledakan atau kebakaran.
-  **Alat ini tidak dirancang untuk penggunaan komersial, dan tidak dimaksudkan untuk digunakan tanpa pemeliharaan yang sesuai.**
  - Jika dilakukan, ini dapat menyebabkan luka bakar atau kebakaran karena beban yang berkelanjutan atau kelebihan beban.

Jangan masukkan alat ini ke dalam air.

Jangan gunakan alat ini di dekat air.

Jangan gunakan alat ini di dekat bak mandi, shower, bak cuci, atau wadah lain yang berisi air.

- Tindakan tersebut dapat menyebabkan sengatan listrik atau kebakaran.



Simbol pada pengering rambut ini berarti “Jangan gunakan alat ini di dekat air”.

**Segera hentikan penggunaan dan cabut steker apabila terdapat ketidaknormalan atau malfungsi.**

- Terus menggunakannya dalam kondisi tersebut dapat menyebabkan kebakaran, sengatan listrik, atau cedera.

**<Kasus ketidaknormalan atau malfungsi>**

- Udara tidak dikeluarkan
- Alat berhenti secara sporadis
- Bagian dalam menjadi sangat panas dan keluar asap
- Segera upayakan pemeriksaan atau perbaikan di pusat layanan resmi.

**Gunakan stopkontak untuk rumah saja: jangan menggunakan kabel ekstensi.**

**Colokkan steker secara sempurna.**

**Pastikan bahwa pengering rambut dioperasikan dengan sumber listrik yang sesuai dengan tegangan dasarnya yang ditunjukkan pada pengering rambut.**

- Penggunaan kabel ekstensi dapat menyebabkan kebakaran atau sengatan listrik.

**Bila Anda melihat percikan api di sekitar lubang udara keluar saat menggunakan pengaturan udara panas, hentikan penggunaan dan singkirkan benang halus dari lubang udara keluar dan lubang udara masuk.**

- Tetap menggunakannya dapat menyebabkan luka bakar atau kebakaran.





## PERINGATAN

**Selalu MATIKAN sakelar daya dan cabut steker dari stopkontak rumah setelah digunakan.**



- Tidak melakukannya dapat menyebabkan kebakaran atau luka bakar.

**Cabut steker dengan cara memegangnya, bukan menarik kabel.**



- Jika diabaikan dapat menyebabkan kawat di dalam kabel putus, dan bisa menyebabkan luka bakar, sengatan listrik, atau kebakaran akibat arus pendek.

**Secara rutin bersihkan steker agar debu tidak menumpuk.**



- Tumpukan debu dapat menyebabkan kebakaran karena kegagalan insulasi yang disebabkan oleh kelembapan.  
Cabut steker dan seka dengan kain kering.

**Ketika alat ini digunakan di kamar mandi, cabut stekernya setelah digunakan karena dapat menimbulkan bahaya ketika berada di dekat air, meskipun alat ini telah dimatikan.**



- Ini untuk menghindari risiko kecelakaan atau cedera.

**Untuk perlindungan tambahan, disarankan pemasangan RCD (residual current device) yang memiliki arus pengoperasian residu terukur tidak melebihi 30 mA dalam rangkaian listrik untuk penggunaan di kamar mandi. Mintalah saran dari petugas yang memasang alat ini.**



- Ini untuk menghindari risiko kecelakaan atau cedera.

**Alat ini tidak untuk digunakan oleh orang (termasuk anak-anak) dengan kemampuan fisik, indera, dan mental yang kurang, atau kurang pengetahuan dan pengalaman, kecuali yang sudah diberi pengarahan atau petunjuk tentang penggunaan alat ini oleh orang yang bertanggung jawab atas keselamatan mereka. Anak-anak harus diawasi untuk memastikan agar mereka tidak bermain-main dengan alat ini.**



- Ini untuk menghindari risiko kecelakaan atau cedera.

**Kabel daya rusak harus diganti oleh pabrik, agen servis atau petugas yang berkualifikasi sama untuk menghindari bahaya.**



- Ini untuk menghindari risiko kecelakaan atau cedera.



## PERHATIAN

**Jangan menyimpan kabel dalam kondisi terpilin.**



- Tindakan tersebut dapat menyebabkan kawat di dalam kabel patah disertai kebocoran arus, dan dapat menyebabkan sengatan listrik atau kebakaran karena arus pendek.

**Jangan jatuhkan dan hindarkan dari benturan.**



- Jatuh atau terbentur dapat menyebabkan sengatan listrik atau terpicunya api.

**Jangan gunakan bila lubang udara masuk rusak.**



- Rambut Anda dapat terbelit di lubang udara masuk, yang dapat merusak rambut Anda.

**Jangan menyentuh lubang udara keluar, dan nosel yang terpasang, yang akan menjadi sangat panas.**



- Tindakan tersebut dapat menyebabkan luka bakar.

**Jangan gunakan pada bayi.**



- Tindakan tersebut dapat menyebabkan luka bakar.





# PERHATIAN

**Ketika membuka atau melipat gagang, jangan menyentuh area yang diberi bayang-bayang seperti pada gambar di bawah ini.**

- Hal tersebut dapat menyebabkan cedera pada jari.

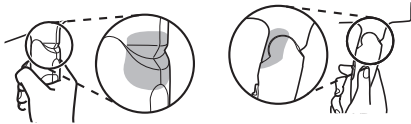

**Jangan melihat ke dalam lubang udara keluar sewaktu alat sedang digunakan.**

- Pengereng rambut mengalirkan udara dengan debu dll. yang dapat menyebabkan cedera.



**Pastikan untuk menjaga jarak lebih dari 3 cm antara lubang udara keluar dan rambut Anda.**

- Kurang dari jarak tersebut, alat dapat menyebabkan rambut Anda terbakar.

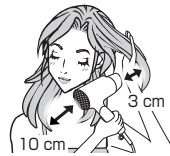

**Pastikan untuk menjaga jarak rambut dari lubang udara masuk alat sekurangnya 10 cm.**

- Rambut Anda dapat terbelit di lubang udara masuk, yang dapat merusak rambut Anda.



**Gunakan hanya untuk mengeringkan atau menata rambut manusia. (Jangan gunakan pada binatang piaraan, atau untuk mengeringkan pakaian, sepatu, dll.)**

- Tidak melakukannya dapat menyebabkan kebakaran atau luka bakar.



## ► Catatan

- Pengereng rambut ini dilengkapi dengan perangkat pelindung panas-berlebih otomatis. Apabila pengereng rambut terlalu panas, alat ini akan beralih ke mode udara dingin. Matikan pengereng rambut dan cabut dari stopkontak rumah. Dinginkan selama beberapa menit sebelum menggunakannya kembali. Pastikan tidak ada debu, rambut, dll. di lubang udara masuk dan lubang udara keluar sebelum menghidupkan alat lagi.

## Identifikasi bagian

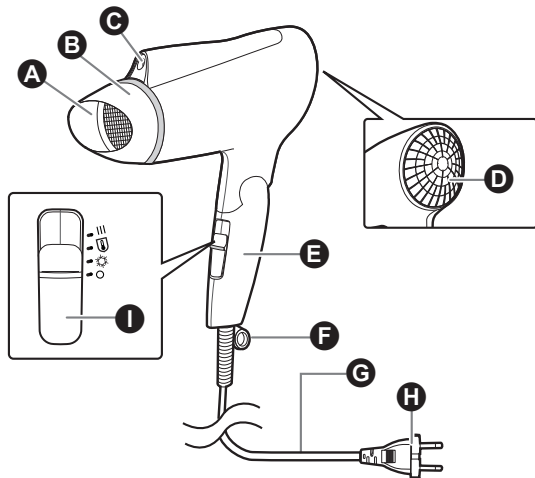

- A** Lubang udara keluar
- B** Setel nosel
- C** Lubang keluar ion **Khusus EH-NE20**
- D** Lubang udara masuk
- E** Gagang
- F** Cincin untuk menggantung
- G** Kabel
- H** Steker

Bentuk steker berbeda- beda tergantung areanya.

### **I** Sakelar daya

- III** Turbo  
(Aliran kuat udara panas)
- U** Pelindung panas  
(Aliran kuat udara hangat)
- ☀** Dingin Kuat  
(Aliran kuat udara dingin)
- O** Mati

(Beberapa petunjuk hanya menggunakan ilustrasi model EH-NE20 untuk menjelaskan produk.)

## Cara menggunakan pengering rambut

- 1** Sebelum menggunakan pengering rambut, pastikan sakelar daya berada pada posisi “○”, lalu tancapkan steker ke stopkontak rumah dan hidupkan sakelar daya.
- 2** Pilih intensitas aliran udara dengan sakelar daya, lalu keringkan rambut Anda.
- 3** Atur sakelar daya ke posisi “○”, lalu cabut steker dari stopkontak rumah.

### ► Setel nosel

Untuk memudahkan penataan rambut dan mengeringkan rambut dengan hembusan udara, pasang nosel pengatur ke pengering rambut.

- Nosel pengatur membantu mengarahkan aliran udara ke area tertentu rambut.

## Tentang ion (khusus EH-NE20)

Ion merupakan partikel yang menggabungkan oksigen bermuatan negatif dan uap air di udara, dan tidak dapat dilihat dengan mata telanjang.

(Metode pembuatan ion: Pelepasan voltase tinggi)

### ► Catatan

- Anda mungkin akan mencium bau khas ketika menggunakan pengering rambut ini. Ini tidak berbahaya bagi tubuh manusia.
- Pengaruh ion dapat tidak terasa oleh orang-orang berikut ini. Orang dengan rambut berombak, rambut sangat keriting, rambut sangat halus, rambut pendek, atau orang yang rambutnya diluruskan dalam tiga atau empat bulan terakhir.

## Tentang pelindung panas

Mode ini memberikan suhu yang konstan dan hangat untuk melindungi rambut dan kulit kepala dari panas.

## Perawatan pengering rambut

Jangan lupa MEMATIKAN sakelar daya dan mencabut steker dari stopkontak rumah. (Kecuali ketika melakukan perawatan pada lubang udara keluar)

### Merawat pengering rambut

Bersihkan bodi utama saat pengering rambut kotor. Bersihkan rumahnya saja dengan kain lembut yang sedikit dibasahi dengan air keran atau air keran bersabun.

#### ► Catatan

- Jangan gunakan alkohol, pembersih cat kuku, atau detergen (sabun tangan cair, dll.).
  - Hal itu dapat menyebabkan kerusakan fungsi, keretakan/ perubahan warna pada komponen alat, dll.
- Membiarkan produk perawatan rambut atau riasan melekat pada gagang atau bodi pengering rambut dapat menurunkan kualitas plastik, yang menyebabkan warna berubah atau retak, dan kerusakan fungsi.

### Merawat lubang udara masuk

Bersihkan lubang udara masuk sebulan sekali atau lebih.

- Usap untuk membersihkan benang halus, rambut, atau bahan lain dari lubang udara masuk dengan tisu atau sikat gigi.

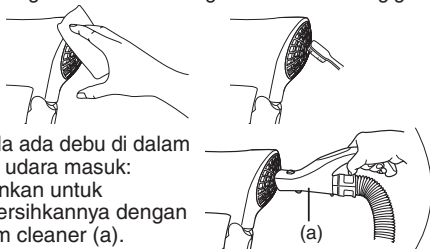

(Apabila ada debu di dalam lubang udara masuk: Disarankan untuk membersihkannya dengan vacuum cleaner (a).)

#### ► Catatan

- Jangan menekan atau menggosok lubang udara masuk dengan kuku atau benda tajam lain.
  - Tindakan demikian dapat merusak lubang udara masuk.

## Merawat lubang udara keluar

Bersihkan lubang udara keluar sekali sebulan atau lebih. Gosok untuk membersihkan debu, rambut, dll. yang menyumbat jala-jala.

- Pengering rambut ini sebaiknya ditancapkan ke stopkontak rumah hanya untuk perawatan lubang udara keluar.
- Atur sakelar daya ke "⚡" dan gunakan aliran udara dingin untuk menghembuskan debu, dsb. sementara Anda menggosoknya dengan sikat gigi.

#### ► Catatan

- Selama perawatan, jangan menghalangi lubang udara masuk dengan tangan, dll.
- Selama atau sesudah perawatan lubang udara masuk, debu dll. dapat tersebar. Pastikan pengering rambut tidak menghembuskan debu, dll dari lubang udara keluar sebelum menggunakan alat. (Jangan melihat ke dalam lubang udara keluar.)

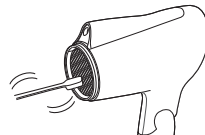

(Gunakan sikat gigi biasa.)

### Merawat lubang keluar ion (Khusus EH-NE20)

Bersihkan lubang keluar ion kira-kira setiap 6 bulan. Dengan perawatan ini, pengering rambut dapat mempertahankan tingkat ion yang dihasilkan dalam waktu yang lama.

- Gunakan kapas korek telinga biasa.

(Kami anjurkan kapas korek telinga tipis untuk bayi.)

- Dengan perlahan masukkan kapas korek telinga sampai berhenti (sekitar 6 mm), dan putar perlahan sebanyak 2 atau 3 kali.



## Pemecahan masalah

Masalah	Kemungkinan penyebab	Tindakan
Alat ini akan sering berganti ke udara sejuk saat digunakan dalam mode “Panas”, atau percikan api dapat terlihat di dalam bodi alat. (Percikan ini disebabkan oleh sakelar termostat, perangkat pelindung, dan tidak berbahaya.)	▶ Benang halus telah menumpuk pada lubang udara masuk atau lubang udara keluar. ▶ Rambut atau sesuatu menyumbat lubang udara masuk.	▶ Singkirkan tumpukan benang halus. ▶ Jangan menutupi lubang udara masuk.
Udara panas secara berulang-ulang berubah menjadi udara sejuk.		
Udara panas menjadi panas secara tidak normal.		
Steker menjadi panas secara tidak normal.	▶ Sambungan ke stopkontak rumah longgar.	▶ Gunakan stopkontak rumah yang sesuai dan kencang.
Keluar percikan api dari dalam lubang keluar ion. (Khusus EH-NE20)	▶ Abnormalitas disebabkan oleh elektroda kotor (bagian jarum).	▶ Lakukan perawatan pada lubang keluar ion.
Lubang keluar ion mengeluarkan bunyi (bunyi keritik). (Khusus EH-NE20)		

Jika masalah masih belum teratasi, hubungi toko tempat Anda membeli alat tersebut atau pusat servis resmi Panasonic untuk perbaikan.

## Spesifikasi

Nama produk	Pengering Rambut		
Model produk	EH-NE20, EH-ND30		
Sumber listrik	220 V ~ 50 - 60 Hz	230 V ~ 50 - 60 Hz	240 V ~ 50 - 60 Hz
Konsumsi listrik	1 500 W	1 650 W	1 800 W
Aksesori	Setel nosel		

Diimpor oleh :  
**PT Panasonic Gobel Indonesia**  
**Jl.Dewi Sartika No.14 (Cawang II),**  
**Jakarta 13630**  
**Telp. (021) 8090108**

Produk ini dimaksudkan untuk penggunaan rumah tangga saja.

# MEMO

**MEMO**

Panasonic Corporation  
<http://www.panasonic.com>  
© Panasonic Corporation 2017