

Model No. **CZ-RTC6BL**  
**CZ-RTC6WBL**

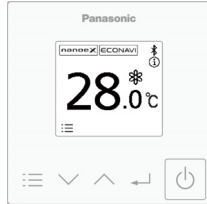

	Page
● Safety Precautions .....	2
● System Overview .....	5
● Part Names (Control panel) .....	6
● Dimensions .....	6
● Installation Precautions .....	7
● Mounting .....	8
● Setting .....	10
● Test run .....	14
● Troubleshooting .....	15
● Specifications .....	16

## ENGLISH

Read through the Installation Instructions before you proceed with the installation.  
In particular, please carefully read the "Safety Precautions".

## Please Read Before Starting

These instructions are all you need for most installation sites and maintenance conditions. If you require help for a special problem, contact our sales/service outlet or your certified dealer for additional instructions.

- **This product is a remote controller that comes equipped with Bluetooth® wireless technology.**

### NOTICE

The English text is the original instructions. Other languages are translations of the original instructions.

## Safety Precautions

We assume no responsibility for accidents or damages resulting from methods other than those described in the Installation Instructions or methods using unspecified parts.

Malfunctions that occur due to unauthorised installation methods are not covered by the product warranty.

- This remote controller must be installed in accordance with National Wiring Regulations.
- Please also read installation instructions of connected devices.
- When relocating or repairing this remote controller, provide the Installation Instructions to the servicing personnel.



### WARNING

This symbol refers to a hazard or unsafe practice which can result in severe personal injury or death.



### CAUTION

This symbol refers to a hazard or unsafe practice which can result in personal injury or product or property damage.



Prohibited matters

## Precautions for Installation setup



### WARNING

- Turn off the circuit breaker of the units before installation.
- Select an installation location which is rigid and strong enough to support or hold this remote controller, and select a location for easy maintenance.
- Use only the parts specified by Panasonic as supplied accessories.
- Ensure cables are installed properly so that external forces cannot affect them.
- Disassembly and modification of this remote controller is not permitted under any circumstances.



## WARNING

- This remote controller must be installed by the sales dealer or installer.
- When installing the remote controller, use appropriate protective equipment and tools for safety.
- This remote controller should be securely installed in accordance with the Installation Instructions.
- Electric work must be performed by authorised personnel in accordance with the local regulations and in accordance with the Installation Instructions.
- To avoid malfunctions caused by radio wave interference, keep the remote controller away from devices such as other wireless device, microwaves and the device that use 2.4 GHz signal. Depending on the area, the module may not be available.
- Attach the electrical cover to the indoor unit securely.
- Make sure to connect the remote controller to the P.C. board and terminal board of the indoor unit properly.
- Do not set up in hospitals or places where electronic medical devices are located.
- If you have a cardiac pacemaker or implantable cardioverter defibrillator, please keep at least 15 cm away from the remote controller.
- Do not use the remote controller near to automatic control equipment (automatic door, fire alarms, etc.).
- In case of an abnormal condition (such as a burning smell), stop the indoor unit and turn the breaker OFF.
- Do not operate with wet hands.
- Do not splash water on the remote controller or use it in the bathroom.



## CAUTION

- Ground yourself to discharge static electricity before performing any wiring.
- Do not install the remote controller in places with direct sunlight or where the ambient temperature is 40 °C or more or is 0 °C or less. Follow specifications. (P.16)
- The connecting cable must not touch piping directly.
- Do not set up where children can reach the remote controller.
- Do not stand on an unstable surface when operating or checking the remote controller.
- Do not use in special environments.  
Use in places with much oil (including machine oil), steam, flammable or corrosive gas, voltage fluctuation, surrounding the metal body, may lead to severe decrease in functionality and damage to parts.
- Do not use the remote controller nearby other wireless devices, microwaves, cordless phones, or facsimiles.

## NOTE

- Install this remote controller vertically.
- When attaching this remote controller, be sure to use the supplied screws and confirm that remote controller is fixed to the surface so that there are no gaps.
- The warranty does not cover the product if it falls from an elevated location.
- Requires a mobile device that is iOS/Android™ compatible.
- The End user should read and accept the Terms of use and Privacy Notice in the contents of “Panasonic H&C Control App”.
- Please avoid to set up multiple remote controller registrations at the same time.
- Users are responsible for all carrier costs associated with installing the “Panasonic H&C Control App” on the mobile device.
- Panasonic Wired Remote Controller is designed for communication to the “Panasonic H&C Control App”.
- Third party Bluetooth® interfaces cannot be connected to the “Panasonic H&C Control App”.
- Updates to the service may mean there are changes to the design of the “Panasonic H&C Control App” screen and display.

### datanavi

This unit supports datanavi.

For details on the usage, supporting regions, etc., visit the following URL.

<https://datanavi.ac.smartcloud.panasonic.com/global/>



## System Overview

Indoor unit (example: 4-way cassette)

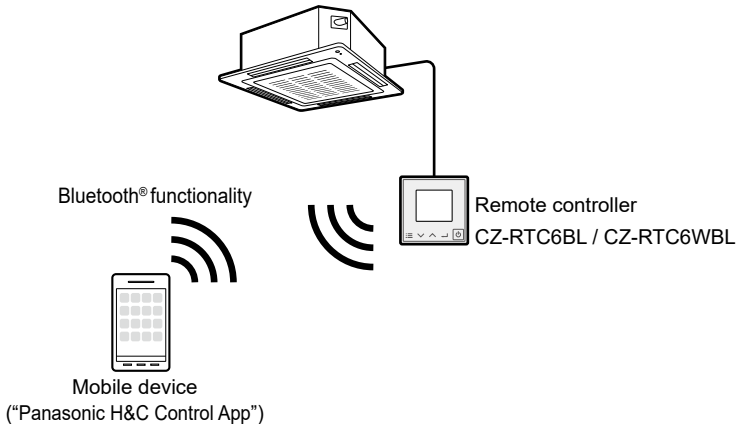

# Part Names (Control panel)

The control panel colour of CZ-RTC6WBL is white.

**1) LCD screen**

**2) Menu button**

- When pressed repeatedly during operation, this shows operating status confirmation, set temperature, operation mode, fan speed, flap, and the menu screen.
- The menu screen is displayed if you press while stopped.

**3) Up/Down buttons**  
Selects an item.

**4) Enter button**  
Fixes the selected content.

**5) Start/Stop button**  
Starts/Stops operation.

**Note**

**Press centre**

**No pen**

**No glove**

## Dimensions

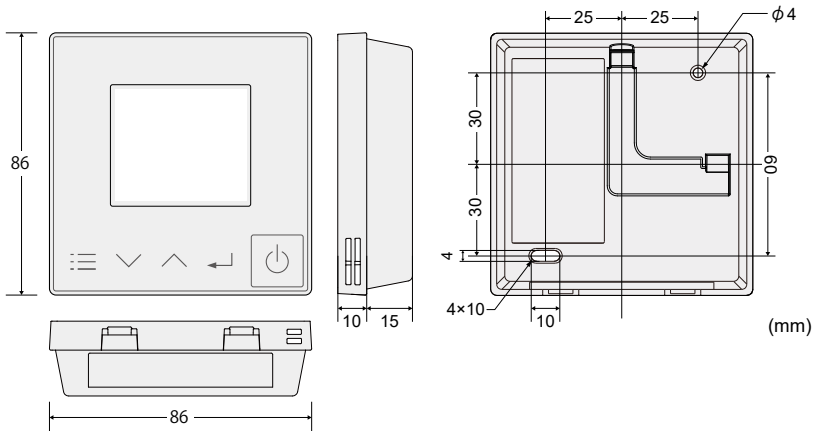

Supplied accessories				
<p><b>Screw</b> M3.8 x 16 (2)</p>	<p><b>Operating Instructions</b> (1)</p>	<p><b>Installation Instructions</b> (1)</p>	<p><b>Instruction</b> (1)</p>	<p><b>Clamper</b> (1)</p>

# Installation Precautions

## Installation location

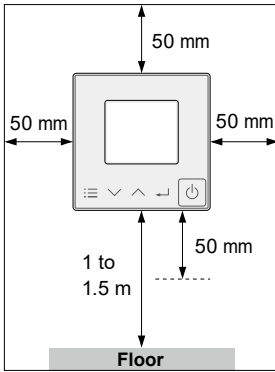

- Install at the height of 1 to 1.5 m from the floor (Location where average room temperature can be detected).
- Keep a space around the remote controller as detailed on the figure shown left.
- Avoid the following locations for installation.
  - In the shadow or backside of objects deviated from the room airflow
  - Location where condensation occurs (The remote controller is not moisture proof or drip proof)
  - Location near heat source
- Keep distance of 1 m or more from the TV, radio and PC. (Image blur or related noise may occur)
- Do not use in special environments. Use in places with much oil (including machine oil), steam, flammable or corrosive gas, voltage fluctuation, surrounding the metal body, may lead to severe decrease in functionality and damage to parts.

## Remote control wiring

### Wiring diagram

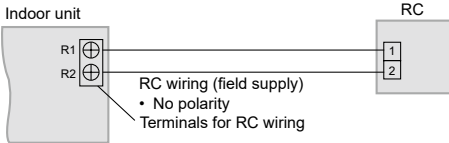

- Type of wiring
  - Use cables of 0.75 to 1.25 mm<sup>2</sup>.
- Total wire length: 500 m or less (The wire length between indoor units should be 200 m or less.)
- Number of connectable units
  - Remote controller:
    - 1 unit connection only
    - When connecting the remote controller to indoor units released in April 2020 and after (PACi NX series and subsequent series), 2 remote controllers can be connected.
    - \* 2 × CZ-RTC6BL (CZ-RTC6WBL) cannot be connected
  - Indoor unit : Max. 8

### Attention

- Use the field supplied RC wiring with at least 1 mm in thickness of insulation part including the sheath.  
Wiring Regulations may differ depending on location. For field wiring rules, please refer to your LOCAL ELECTRICAL CODES.  
You must ensure that installation complies with relevant rules and regulations.
- Be careful not to connect cables to other terminals of indoor units (e.g. power source wiring terminal). Malfunction may occur.
- Do not bundle together with the power source wiring or store in the same metal tube. Operation error may occur.
- If noise is induced to the unit power supply, attach a noise filter.

## ■ Using 1 indoor unit

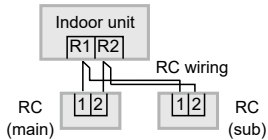

## ■ Using more than 1 indoor unit

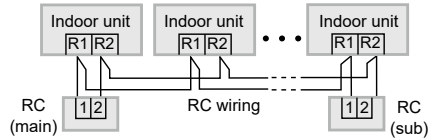

Wiring as shown below is prohibited.

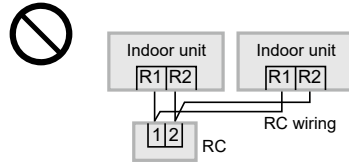
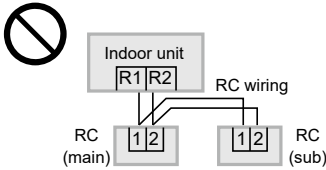

## When setting both the main and sub remote controllers

After installation, set one remote controller to [Main] and the other to [Sub] for [Main/sub] for "Setting". (See "Setting" section - "RC. setting mode")

When using the remote controllers\* in combination, set the CZ-RTC6BL or CZ-RTC6WBL unit to [Main].  
\*CZ-RTC4, CZ-RE2C2, or CZ-RTC6 (CZ-RTC6W)

**Note** Remote controllers can be connected to any indoor unit for operation.

# Mounting

## 1

### Remove the top case.

#### ① Insert the screwdriver to the bottom case.

Insert the flat-blade screwdriver to the claws as show in the figure.

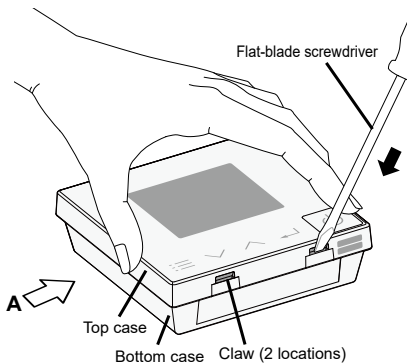

#### ② Push the flat-blade screwdriver in.

Push down the flat-blade screwdriver along with the slope of the claws until the top case comes off.

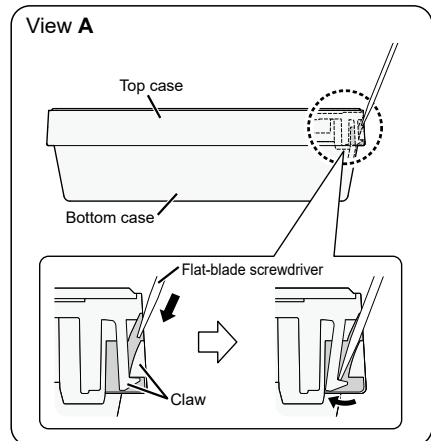



# 2 Mount to the wall.

There are 2 types of wall-mounting methods: Exposed type and Embedded type.

## Attention

### Mounting the bottom case

- Tighten the screws securely until the screw heads touch the bottom case.  
(Otherwise, loose screw heads may hit the PCB and cause malfunction when mounting the top case.)
- Do not over-tighten the screws.  
(The bottom case may be deformed, resulting in the unit becoming detached from the surface it is fixed to.)

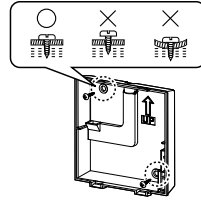

### Connection to the remote controller terminal board

- Depress the push button using a round bar or finger, insert the remote control wiring securely from the wiring insertion slot and release the push button.
- Pull the remote control wiring lightly, and confirm it is secured.
- There is the danger of shorting if copper wire is exposed. Make sure the wire is properly inserted.

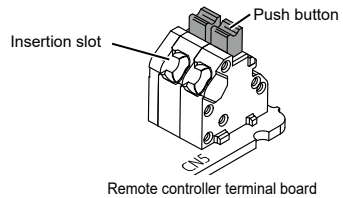

## Exposed type

A protective film is attached on the Control panel.

### 1 Mount the top case.

- Align the claws of the top case and then align the claws of the bottom case.

### 1 Mount the bottom case to the wall.

- Pass the wire through the wiring hole in the bottom case and lay the wire out along the groove.

Remove the coating. Approx. 9 mm

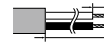

Remove the sheath. Approx. 130 mm

- Make sure the wiring connection is in the correct direction.
- There will be a slight difference in length due to the wiring diameter, so make adjustments on site when performing the installation.

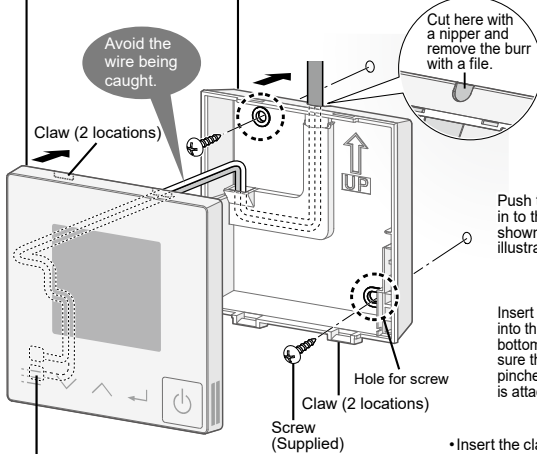

Push the sheath in to the back as shown on the illustration.

Insert the wire properly into the channel on the bottom case; and make sure the wire is not pinched when the case is attached to the wall.

Remote controller terminal board

Clamper (supplied)

- Insert the clamper from the position indicated by the arrow, as shown in the diagram at right.
- Put the locking part of the clamper in the channel as indicated by the arrow.
- If you lock at the top, it may not be possible to close the bottom case.

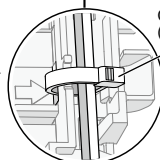

### 2 Connect the remote control wiring.

- Be sure not to allow unnecessary wires to remain in the remote controller case when wiring. Be careful not to allow wires to be in contact with parts on the PCB. For connection method, refer to "Connection to the remote controller terminal board" in "Attention".

\*It is also possible to mount in the order 2-1-3

## Embedded type

A protective film is attached on the Control panel.

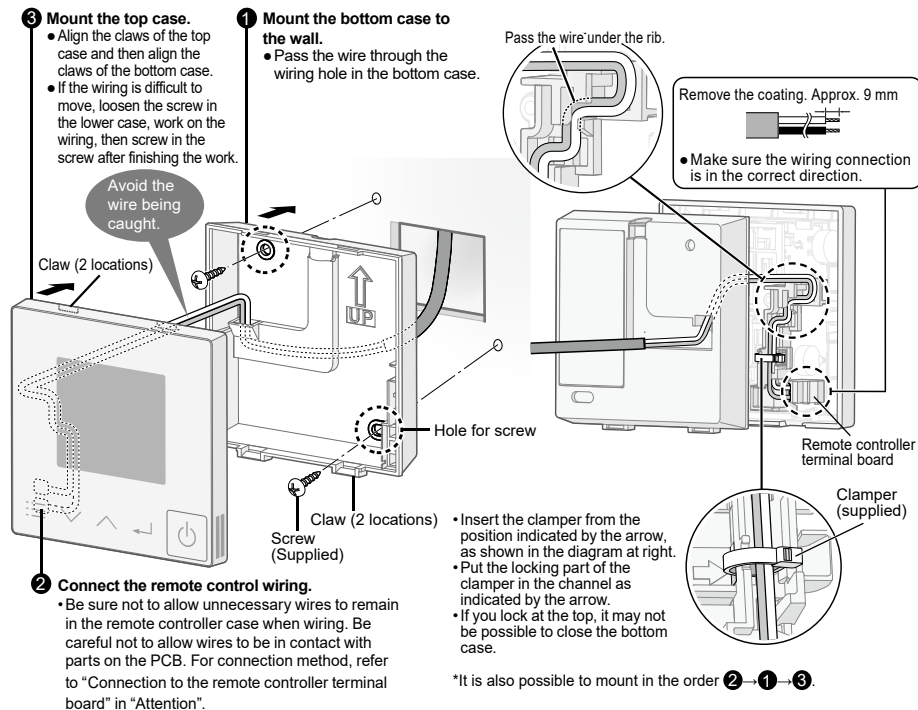

## Setting

**Preparation:** Turn on the circuit breaker of units and then turn the power on. The remote controller starts, and wait until the [Assigning] display disappears.  
(If [Assigning] continues to blink for 10 minutes or more, check the address setting of indoor units. Refer to indoor/outdoor unit installation details.)

## Menu

### ■Language ■Clock ■Bluetooth® functionality

Steps 1 and 2 are common operations for each item.

#### 1 ■When stopped

Press .

#### ■When operating

Press  repeatedly until the menu screen is displayed.

•To return to the top screen, press .

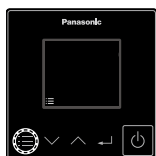

#### 2 Select the item to set.

Press



Total number of items  
Number for the  
selected item



## Language

- 3** Select the language to display from among 7 languages shown on the right.

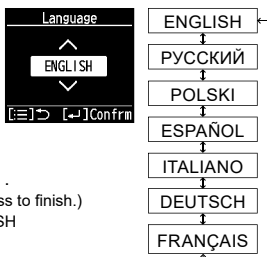

Press → → .  
(Press to finish.)  
• Default setting : ENGLISH

## Clock

- 3** Set the preset date and time.

Press → (Repeat)  
→ . (Press to finish.)

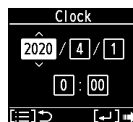

• [-] appears in situations where the clock is reset, such as when power is not supplied to the remote controller for 24 hours or more.

## Bluetooth® functionality

- 3** Select [Enable/disable].

Press → .

Total number of items  
Number for the selected item



- 4** Select [Enable].

Press →   
→ .  
(Press twice to finish.)

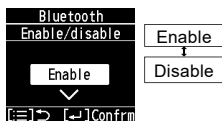

### To disable Bluetooth® functionality

1. Start with step 1 and select [Disable] in Step 4.
2. Press .
3. Press twice to finish.

## ■ Connecting with the “Panasonic H&C Control App”

Before connecting, set Bluetooth® functionality to [Enable].(Step 4)

When connecting, try getting the mobile device as close as possible to the remote controller.

1. Start the “Panasonic H&C Control App”.
2. Select the remote controller you want to operate.

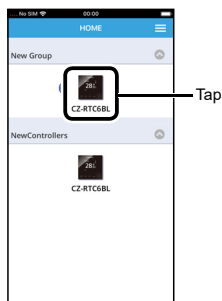

• If the remote controller is not displayed, slide down to update and the remote controller is detected.

- The following Steps 3 and 4 are required only when connecting for the first time.
3. Confirm the numbers on the mobile device match the 6 digits on the remote controller.

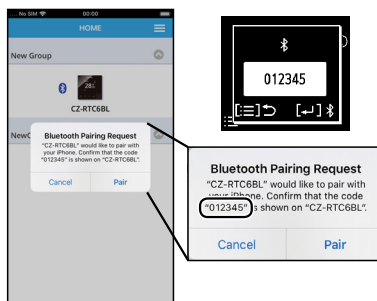

4. Start connecting.

### ■ Mobile device

Tap “Pair”.

### ■ Remote controller

Press .

- is displayed on the top screen when the Bluetooth® connection is established. Once this step is complete, subsequent connections will be made automatically.

When Bluetooth® connection is complete, mobile device information is stored, and the above Steps 3 and 4 are unnecessary next time Bluetooth® connection is made.

# Maintenance func

- RC. setting mode   ■ Auto address   ■ Detailed settings   ■ Sensor info.   ■ Service check
- Set elec. consumption

Check this item as necessary.

Steps 1 and 2 are common operations for each item.

**1** Press and hold the 3 buttons simultaneously, for at least 4 seconds.

Press , , .

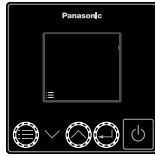

**2** Select the item to set.

Press → .

Total number of items

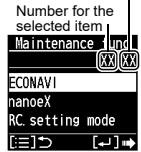

## RC. setting mode

**3** Set.  
(Select the Code no. and Set data.)

Press → . (Repeat)

**4** Press .

- After Selecting [YES], the unit restarts.

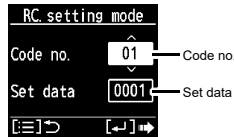

Code no.		Set data
01	Main/sub	Set this when using 2 remote controllers. <ul style="list-style-type: none"> <li>• 0000: Sub</li> <li>• 0001: Main (factory setting)</li> </ul>
2F	Password change	Set the administrator password. <ul style="list-style-type: none"> <li>• 0000 to 9999</li> <li>• 0000 (factory setting)</li> </ul>

## Auto address

**3** Set.  
(Select the Code no. [A1] and O/D unit no.)

Press → . (Repeat)

**4** Press .

- After Selecting [YES], the unit restarts.

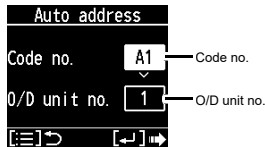

Code no.		O/D unit no.
A1	Set the Auto address for each O/D unit no. Select the O/D unit no. (outdoor unit) for Auto address.	<ul style="list-style-type: none"> <li>• Outdoor unit number</li> </ul>

### Attention

- Set Auto address after all units are turned on and 90 seconds or more have passed.
- Operate the units after Auto address is set and 90 seconds or more have passed.

## Detailed settings

### 3 Set.

(Select the indoor unit number, Code no. and Set data.)  
(When selecting Code no., refer to the following table.)

Press → . (Repeat)

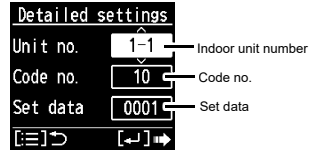

### 4 Press .

• After Selecting [YES], the unit restarts.

Code no.	Set data
31 Vent output setting	Set this when connecting a commercially sold fan, etc. to the ventilation fan output "FAN DRIVE:2P (White)" on the indoor control board. *Dedicated cables (optional) are required.
32 Temp sensor setting	Set this when measuring the room temperature with the room temperature sensor of the remote controller. • When using the main and sub remote controllers, the main one is enabled. • When using with the remote sensor in combination, set the indoor unit setting data. * This setting is not available during group-controlling.
33 Temp display setting	Set the type of temperature display.

\* Depending on the type of indoor unit, Code no. may be displayed with 6 digits. In this case, read as follows.  
e.g. 10 → 000010

## Sensor info.

This displays each sensor temperature of the remote controller, indoor units and outdoor units.

### 3 Select.

(Select the unit number and Code no.)

Press

→ . (Repeat)

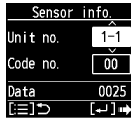

### 4

### Confirm the content.

Press .

• Pressing will return to the Maintenance func screen.

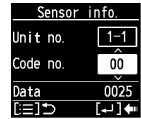

## Service check

This displays the alarm history.

### 3 Confirm the content.

Press .

Information of the last 4 errors is displayed.  
[-] shows that no error has occurred.

• Pressing will return to the Maintenance func screen.

• To delete the error history, press and select [YES].

Service check		
Unit no.	Alarm	
1	1-1	E04
2	1-1	F10
3	1-2	P01

Delete

## Set elec. consumption

### 3 Set.

(Select the power supply voltage of outdoor units.)

Press

→ .

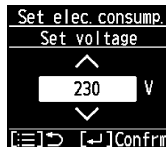

#### Note

- Set the power supply voltage of outdoor units to calculate electric consumption of the Power consumption monitor.
- If the setting differs from the power supply voltage of outdoor units, the electric consumption value of the Power consumption monitor will differ from the actual calculation result by a power meter.
- Depending on the outdoor unit model, this cannot be set.

### 4

Select [YES].

#### ■ When 3-phase model connections are used for outdoor units

Power supply voltage	Setting value
380 V	220 V
400 V	230 V
415 V	240 V

# Test run

**1 Press and hold the 3 buttons simultaneously, for at least 4 seconds.**

Press , , .



**2 Select [Test run].**

Press → .

Total number of items  
Number for the selected item



**3 Select [ON].**

(The unit enters the test operation mode. Then, [TEST] turns on.)

Press → .

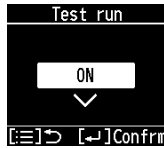

**4 Perform the test operation.**

Press .



Press .

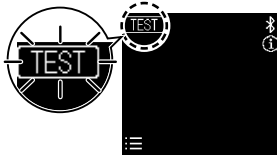

**5 Finish the test operation.**



Perform step 1 and 2, and then select [OFF] in step 3. ([TEST] display disappears.)

- The test operation can be performed in Heat or Cool mode.
- Temperature cannot be changed.
- The test operation mode is automatically turned off in 60 minutes. (To prevent continuous test operation)
- Outdoor units do not operate for approx. 3 minutes after the power is turned on or operation is stopped.

### Attention

- Do not use this mode for purposes other than the test operation. (To prevent overload of the units)
- Read the Installation Instructions supplied with the units.

# Troubleshooting

<p>The “Panasonic H&amp;C Control App” cannot be installed in mobile device.</p>	<ul style="list-style-type: none"> <li>● Check if OS of the mobile device is compatible. The “Panasonic H&amp;C Control App” is not guaranteed to work with all versions of iOS and Android™ OS.</li> </ul> <p>See page 16 for the versions of the OS for mobile devices that are supported by the “Panasonic H&amp;C Control App” and the Bluetooth® versions.</p>
<p>Remote controller and mobile device cannot be connected via Bluetooth® functionality.</p>	<ul style="list-style-type: none"> <li>● Confirm that the remote controller is turned on.</li> <li>● Check the following if “” is not displayed on the top screen. <ul style="list-style-type: none"> <li>– Confirm that the Bluetooth® setting on the remote controller is set to [Enable]. (refer to page 11)</li> <li>– If the mobile device to be connected by Bluetooth® functionality is far away from the remote controller, try getting it as close as possible to the remote controller.</li> <li>– Check the connection method of the remote controller and that of the mobile device (refer to page 11).</li> </ul> </li> </ul>
<p>The remote controller screen displays “” ↔ “”. (alternately)</p>	<ul style="list-style-type: none"> <li>● Bluetooth® module is considered abnormal. →Set Bluetooth® functionality to [Disable] with the remote controller (refer to page 11 ) and contact the retailer or point of purchase with the Model No. and problem.</li> </ul>
<p>Change of mobile device’s model.</p>	<ul style="list-style-type: none"> <li>● Ensure the mobile device compatibility. Install the “Panasonic H&amp;C Control App” and start it. Complete by initial connection setup. (refer to page 11)</li> </ul>
<p>Change of remote controller.</p>	<ul style="list-style-type: none"> <li>● Confirm that the Bluetooth® setting on the remote controller is set to [Enable].</li> <li>● Complete by initial connection setup. (refer to page 11)</li> </ul>

# Specifications

Model No.		CZ-RTC6BL / CZ-RTC6WBL
Dimensions		(H) 86 mm × (W) 86 mm × (D) 25 mm
Weight		0.09 kg
Temperature/Humidity range		0 °C to 40 °C / 20% to 80% (No condensation) *Indoor use only.
Power Source		DC16 V (supplied from indoor unit)
Clock	Precision	± 30 seconds/month (at normal temperature 25 °C) *Adjust periodically.
	Holding time	24 hours (When fully charged) (at normal temperature 25 °C) *Approx. 8 hours are required for full charge.
Number of connected indoor units		Indoor unit: Up to 8 units (Within group-controlling)
OS version on the mobile device for "Panasonic H&C Control App"		Check on the relative app store for supported OS versions.
Bluetooth® version		4.2 or later

- The Bluetooth® word mark and logos are registered trademarks owned by Bluetooth SIG, Inc. and any use of such marks by Panasonic Corporation is under license. Other trademarks and trade names are those of their respective owners.
- iOS is the name of the OS of Apple Inc. IOS is a trademark or registered trademark of Cisco in the US and other countries which has been licensed for use.
- Apple and the Apple logo are trademarks of Apple Inc. that are registered in the US and other countries. App Store is a service mark of Apple Inc.
- Android™, Google Play™ and Google Play™ logos are registered trademarks of Google LLC.

## Maximum radio-frequency power transmitted in the frequency bands

Type of wireless	Frequency band	Max EIRP (dBm)
Bluetooth® functionality	2402 - 2480 MHz	6.7 dBm



