

Panasonic®

Operating Instructions (Household) Rechargeable Body Hair Trimmer

Model No. ER-GK60



Operating Instructions
(Household) Rechargeable Body Hair Trimmer
Model No. ER-GK60

Contents

Safety precautions	4	Troubleshooting	13
Intended use	7	Blade life.....	14
Parts identification	8	Battery life	14
Preparation.....	8	Removing the built-in rechargeable battery.....	14
Read before use.....	9	Specifications	15
Using the trimmer.....	11		
Cleaning the trimmer.....	12		

Thank you for purchasing this Panasonic product.



Before operating this unit, please read these instructions completely and save them for future use.

Safety precautions



To reduce the risk of injury, loss of life, electric shock, fire, and damage to property, always observe the following safety precautions.

Explanation of symbols

The following symbols are used to classify and describe the level of hazard, injury, and property damage caused when the denotation is disregarded and improper use is performed.

 DANGER	Denotes a potential hazard that will result in serious injury or death.
 WARNING	Denotes a potential hazard that could result in serious injury or death.
 CAUTION	Denotes a hazard that could result in minor injury or property damage.

The following symbols are used to classify and describe the type of instructions to be observed.

 This symbol is used to alert users to a specific operating procedure that must not be performed.
 This symbol is used to alert users to a specific operating procedure that must be followed in order to operate the unit safely.

WARNING

► This product

 **This product has a built-in rechargeable battery. Do not throw into flame or heat.**

- Doing so may cause fluid leak, overheating, or explosion.

Do not modify or repair.

 - Doing so may cause fire, electric shock, or injury.

Contact an authorized service center for repair (battery change, etc.).

 **Never disassemble except when disposing of the product.**

- Doing so may cause fire, electric shock, or injury.

► **In case of an abnormality or malfunction**
Immediately stop using and remove the power plug if there is an abnormality or malfunction.

- Failure to do so may cause fire, electric shock, or injury.

<Abnormality or malfunction cases>

-  • **The main unit or AC adaptor is deformed or abnormally hot.**
- **The main unit or AC adaptor smells of burning.**
- **There is abnormal sound during use or charging of the main unit or AC adaptor.**

- Immediately request inspection or repair at an authorized service center.

► Power supply

 **Do not connect or disconnect the power plug to a household outlet with a wet hand.**

- Doing so may cause electric shock or injury.

WARNING

Do not place the AC adaptor over or near water filled sink or bathtub.

Do not immerse the AC adaptor in water or wash with water.

Never use the appliance if the AC adaptor is damaged or if the power plug fits loosely in a household outlet.



Do not damage or modify, or forcefully bend, pull, or twist the cord.

Also, do not place anything heavy on or pinch the cord.

- Doing so may cause electric shock or fire due to a short circuit.

Do not use in a way exceeding the rating of the household outlet or the wiring.



- Exceeding the rating by connecting too many plugs to one household outlet may cause fire due to overheating.

Do not use anything other than the supplied AC adaptor for any purpose.



Also, do not use any other product with the supplied AC adaptor. (See page 8.)

- Doing so may cause burn or fire due to a short circuit.

Always ensure the appliance is operated on an electric power source matched to the rated voltage indicated on the AC adaptor.



Fully insert the power plug.

- Failure to do so may cause fire or electric shock.

Always unplug the power plug from a household outlet when cleaning.



- Failure to do so may cause electric shock or injury.

Regularly clean the power plug and the charging plug to prevent dust from accumulating.



- Failure to do so may cause fire due to insulation failure caused by humidity.

Disconnect the adaptor and wipe with a dry cloth.

▶ Preventing accidents

Do not place within the reach of children or infants.



Do not let them use it.

- Putting parts or accessories in the mouth may cause accidents and injury.

If the oil is consumed accidentally, do not induce vomiting, drink a large amount of water, and contact a physician.



If the oil comes into contact with eyes, immediately wash thoroughly with running water, and contact a physician.

- Failure to do so may result in physical problems.

If you experience skin irritation or pain while using the trimmer, stop using immediately and consult a physician.



- Failure to do so may result in physical injury or injury to the skin.

This appliance is not intended for use by persons (including children) with reduced physical, sensory or mental capabilities, or lack of experience and knowledge, unless they have been given supervision or instruction concerning use of the appliance by a person responsible for their safety. Children should be supervised to ensure that they do not play with the appliance.



- Failure to do so may cause an accident or injury.

The supply cord cannot be replaced. If the cord is damaged, the AC adaptor should be scrapped.



- Failure to do so may cause an accident or injury.



CAUTION

► Protecting the skin

Do not press the blade against the skin.

Do not use this product without an attachment to trim hair in the following areas: bikini zone, buttocks, anus, and surrounding areas.

Do not use the appliance to trim hair in the following areas.

-  · Face or head (hair, beard, etc.)
-  · Areas with rough or bumpy skin (swollen areas, cuts, hemorrhoids, and other protuberances; nipples and surrounding areas)
-  · Moles, bruises, etc.

Do not use this product for any purpose other than trimming body hair.

- Doing so may cause skin injury.

-  **Check that the blades are not damaged or deformed before use.**

- Failure to do so may cause skin injury.

► Note the following precautions

Do not allow metal objects or trash to adhere to the power plug or the charging plug.

-  - Doing so may cause electric shock or fire due to a short circuit.

Do not share your trimmer with your family or other people.

- Doing so may result in infection or inflammation.

Do not drop or hit against other objects.

- Doing so may cause injury.

-  **Do not wrap the cord around the AC adaptor when storing.**

- Doing so may cause the wire in the cord to break with the load, and may cause fire due to short circuit.

-  **Disconnect the power plug from the household outlet when not using.**

- Failure to do so may cause electric shock or fire due to electrical leakage resulting from insulation deterioration.

-  **Disconnect the power plug by holding onto the power plug instead of the cord.**







- Failure to do so may cause electric shock or injury.

Handling of the removed battery when disposing

DANGER

The rechargeable battery is exclusively for use with this trimmer. Do not use the battery with other products.

Do not charge the battery after it has been removed from the product.

-  · Do not throw into fire or apply heat.
-  · Do not solder, disassemble, or modify the battery.
-  · Do not let the positive and negative terminals of the battery get in contact with each other through metallic objects.
-  · Do not carry or store the battery together with metallic jewellery such as necklaces and hairpins.
-  · **Never peel off the tube.**
-  - Doing so may cause fluid leak, overheating, or explosion.

WARNING



After removing the rechargeable battery, do not keep it within reach of children and infants.

- The battery will harm the body if accidentally swallowed. If this happens, consult a physician immediately.

If the battery fluid leaks out, do not touch the battery with your bare hands.

- The battery fluid may cause blindness if it comes in contact with your eyes.



Do not rub your eyes. Wash immediately with clean water and consult a physician.

- The battery fluid may cause inflammation or injury if it comes in contact with the skin or clothes.

Wash it off thoroughly with clean water and consult a physician.

Intended use

- This WET/DRY trimmer can be used for wet trimming or for dry trimming. You can use this watertight trimmer in a shower and clean it with water. The following symbol means that it is suitable for use in a bath or shower.



- Before using an attachment, check that it has been installed correctly. Failure to do so may cause hair to be cut too short.
- The appliance should not be used on animals.
- Before and after each use, apply oil at the places marked with arrows. (See page 13.)
Failure to apply the oil may cause the following problems.
 - The trimmer has become blunt.
 - Shorter operating time.
 - Louder sound.
- Do not use thinner, benzene, alcohol or other chemicals. Doing so may cause failure, cracking or discoloration of the main body. Clean the main body only with a soft cloth slightly dampened with tap water or soapy tap water.
- Store the trimmer in a place with low humidity after use. Failure to do so may cause malfunction due to condensation or rust.
- The following symbol indicates that a specific detachable power supply unit is required for connecting the electrical appliance to the supply mains. The type reference of power supply unit is marked near the symbol.



Parts identification

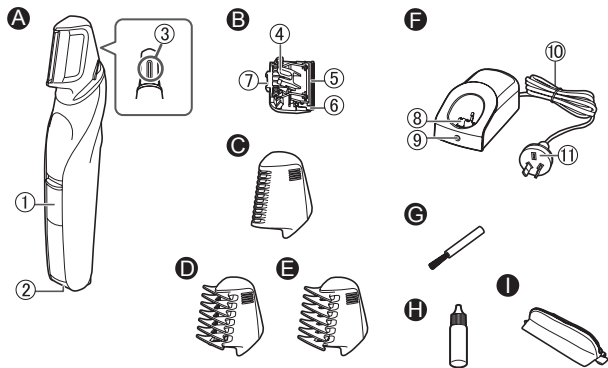

A Main body

- ① Power switch [○ / |]
- ② Appliance socket
- ③ Water inlet

B Blade

- ④ Cleaning lever
- ⑤ Moving blade
- ⑥ Stationary blade
- ⑦ Mounting hook

C Attachment for groin

D Length adjustment comb attachment (3 mm)

E Length adjustment comb attachment (6 mm)

F AC adaptor (RE9-90)

- ⑧ Charging plug
- ⑨ Charge indicator lamp
- ⑩ Cord
- ⑪ Power plug

Accessories

G Cleaning brush

H Oil

I Pouch

- Attach one of the attachments when carrying the trimmer.

Preparation

Charging the trimmer

- Make sure that the trimmer is turned off.
- Wipe off any water droplets on the appliance socket.

1 Place the trimmer on the AC adaptor.

2 Insert the power plug into a household outlet.

- The charging time differs depending on the rated voltage. (See page 15.)
- Check that the charge indicator lamp glows.

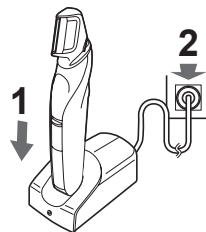

3 Disconnect the power plug after charging is completed.

(for safety and to reduce energy usage)

The charge indicator lamp continues to glow after charging is complete. There is no indication to show that "charging is complete".

You cannot operate the trimmer while charging.







Notes

- If there is noise from the radio or other sources while using or charging the appliance, move to a different location to use the appliance.
- When the appliance is not used for 6 months or more, the battery will weaken (leak battery fluid, etc.). Fully charge the battery once every 6 months.
- When charging the trimmer for the first time or when it has not been in use for more than 6 months, the charging time may change or the lamp on the AC adaptor may not glow for a few minutes, or the operating time may shorten. Please charge it for more than 18 hours in such cases.
- Recommended ambient temperature for charging is 0 °C – 35 °C. Battery performance may decrease outside of the recommended temperature.
- A full charge supplies enough power for approximately 40 minutes of use. (Based on dry using at 20 °C – 30 °C)
The operating time may differ depending on the frequency of use, the operating method and the ambient temperature.
- You can charge the battery before it is completely discharged. However, it is recommended to charge when the battery is completely discharged. The battery life depends strongly on factors such as how it is used and stored.

Read before use

Areas of use

✓ OK ✗ Do not use

Area		When used with an attachment	When used without an attachment
Bikini zone <ul style="list-style-type: none">• Genitalia• Genital area• Crotch		✓	✗
<ul style="list-style-type: none">• Buttocks• Anus• Perianal region		✓	✗
Armpits		✓	✓
Chest		✓	✓
Navel area		✓	✓
Arms, hands		✓	✓
Legs		✓	✓

- Using this trimmer to trim hair in areas that are not visually accessible may result in cuts or injury. Please use with care.

How to use the trimmer

- Using this trimmer to trim hair in the shaded areas () below may result in cuts or injury. Be sure to use an attachment.

Bikini zone



Buttocks



Notes

- Stretch the skin on the areas with loose or flabby skin, or with wrinkles, and lightly apply the edge of the blade or attachment.
- Do not use the attachment on wet hair. Wet hair might clump or stick to the skin, becoming hard to trim. If you use the attachment to trim wet hair, you may not be able to achieve a uniform trim.
- For areas with thick or dense hair growth, trim a bit at a time. Hair sometimes gets caught or builds up in the attachment. When this happens, clean the attachment. (See page 12.)

Without attachment

Apply light pressure and slowly move the trimmer against the direction of hair growth.



- To trim navel hair, lay the blade flat against your skin and then move the trimmer in a gliding motion. This allows you to trim hair down to a length of approximately 0.1 mm.
- It does not matter which side of the blade you lay against your skin.

Attachment for groin



Lightly apply the edge of the attachment for groin against your skin and then slowly move the trimmer.

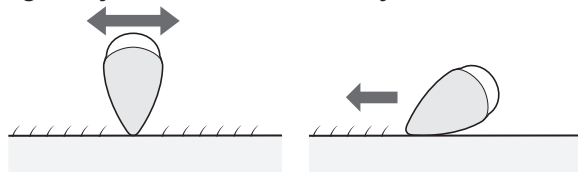

- This allows you to safely trim hair down to a length of approximately 2 mm.

Length adjustment comb attachment



Lightly apply the edge (flat part) of the length adjustment comb attachment against your skin and then slowly move the trimmer.

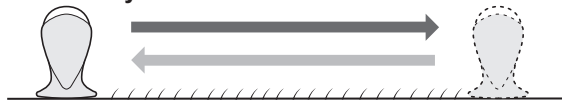

- This allows you to trim hair down to a length of approximately 3 mm or 6 mm.

Removing and mounting the attachments

- Take care not to injure hands, etc., with the blade when removing or mounting the attachment.
- Make sure that the trimmer is turned off.
- All the attachments have the same method of mounting and removing.

Mounting the attachment

Mount the attachment to the main body until it clicks.

- If the attachment is not attached correctly, it may shift and end up cutting too much during use.



Removing the attachment

Firmly grasp the main body in one hand and, with the other hand, firmly pinch the ribbed part of the attachment (a). Pull to remove the attachment from the main body.

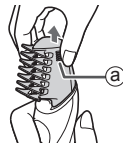

Using the trimmer

- Check that the blades are not damaged or deformed before use.
- Apply the oil to the blade before and after each use. (See page 13.)
- When you finish using the trimmer, turn it off.
- The appliance may not operate in an ambient temperature approximately 0 °C or lower.

Trimming dry hair

- Use the appropriate attachment as needed. (See pages 10 and 11.)

- 1 Slide the power switch on the main body to the “ | ” position to turn on the power.
- 2 Trim.



Trimming wet hair

- Do not use the attachment when trimming wet hair.

- 1 Wet and apply soap to your body.
- 2 Slide the power switch on the main body to the “ | ” position to turn on the power.
- 3 Apply less pressure than you would when trimming dry hair, and move the trimmer in a gliding motion.



Cleaning the trimmer

- Clean the trimmer and the blade after each use. (If not cleaned, the motion will become poor and the sharpness will worsen.)
- Make sure that the trimmer is turned off.
- Remove the trimmer from the AC adaptor.

► With water

Main body, blade and the attachment

To remove light dirt

1. Remove the attachment and turn the trimmer on.
2. Run water down the water inlet at the back of the main body, rinse thoroughly for approximately 20 seconds, and then turn the trimmer off.

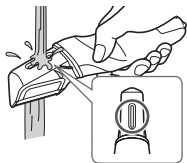

- Rinse with water and shake up and down several times to remove the water.

To remove heavy dirt

1. Remove the attachment and blade.
2. Clean the trimmer, the blade and the attachments with running water.

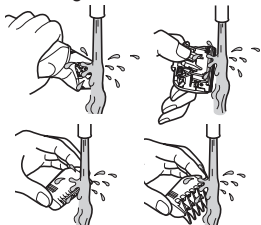

- Rinse with water and shake up and down several times to remove the water.

- Be careful not to hit the main body on the sink or any other object while draining the water. Failure to do so may cause malfunction.

3. Wipe off the water with a towel and let it dry naturally.
 - It will dry faster with the blade removed.
4. Apply the oil to the blade after drying. (See page 13.)
5. Attach the attachment and the blade to the main body.

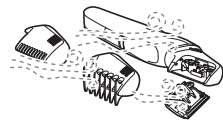

► With the brush

Main body and blade

- Remove the blade. (See page 13.)
- 1. Brush off any hair trimmings from the main body and from around the blade.



2. Brush off the hairs from the blade edge.
3. Brush any hair trimmings out from between the stationary blade and the moving blade while pressing down the cleaning lever (b) to raise the moving blade.

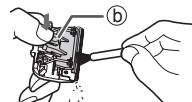

4. Apply the oil to the blade. (See page 13.)
5. Attach the attachment and the blade to the main body.

AC adaptor

Use the cleaning brush to clean hair trimmings and dust in the charging plug or in the hole on the bottom surface.



Lubrication

- Apply the oil to the blade before and after each use.

- 1 Remove the blade.**
- 2 Apply a drop of the oil to each indicated point.**
- 3 Attach the blade to the main body, turn on the power and allow to run for approximately 5 seconds.**

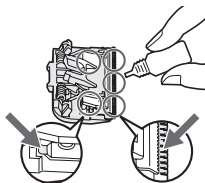

Removing and mounting the blade

Removing the blade

Hold the trimmer and push the blade with your thumb.

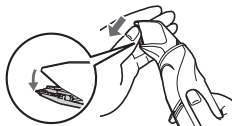

Mounting the blade

Fit the mounting hook (B) into the blade mounting (A) on the trimmer and then push in until you hear a click.

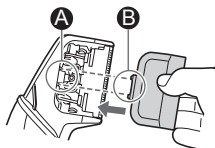

Troubleshooting

Perform the following actions.

If the problems still cannot be solved, contact the store where you purchased the unit or a service center authorized by Panasonic for repair.

Problem	Action
The trimmer has become blunt.	Until problems are solved, please follow each procedure as follows; 1. Charge the trimmer. (See page 8.) ▶ 2. Clean the blade and apply oil. (See pages 12 and 13.) 3. Replace the blade. (See this page.) 4. Contact the store where purchased.
Trimmer stopped functioning.	Charge the battery for approximately 18 hours continuously to rejuvenate it.
Operating time is short.	If few uses remain even after charging, the battery has reached the end of its life. (Fluid may be leaking due to degradation at the end of battery life.) ▶ Contact an authorized service center for repair.
The trimmer cannot be charged.	▶ Mount the main body firmly on the charging plug, and make sure the charge indicator lamp glows.
Makes a loud sound.	▶ Apply oil. (See this page.) ▶ Confirm that the blade is properly attached.

Blade life

Blade life varies according to the frequency and period of use of the trimmer.

For example, the blade life is approximately 3 years when using the trimmer for 10 minutes once a week. Replace the blades if cutting efficiency reduces substantially despite proper maintenance.

Battery life

Battery life will vary according to the frequency and length of use. If the battery is charged once a month, the service life will be approximately 3 years.

If the operating time is significantly shorter even after a full charge, the battery has reached the end of its life.

Removing the built-in rechargeable battery

Remove the built-in rechargeable battery before disposing of the trimmer.

Please make sure that the battery is disposed of at an officially designated location if there is one.

This figure must only be used when disposing of the trimmer, and must not be used to repair it. If you dismantle the trimmer yourself, it will no longer be waterproof, which may cause it to malfunction.

- Remove the trimmer from the AC adaptor.
- Slide the power switch to turn on the power and then keep the power on until the battery is completely discharged.
- Perform steps ① to ⑧ and lift the battery, and then remove it.
- Take care not to short circuit the positive and negative terminals of the removed battery, and insulate the terminals by applying tape to them.

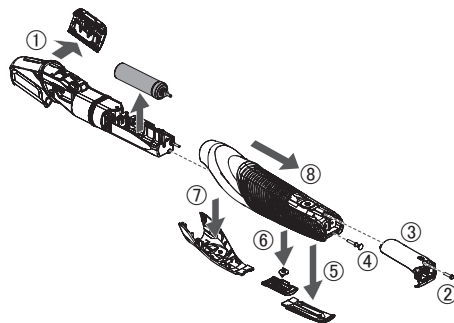

For environmental protection and recycling of materials

This trimmer contains a Nickel-Metal Hydride battery.

Please make sure that the battery is disposed of at an officially assigned location, if there is one in your country.

Specifications

Power source	See the name plate on the AC adaptor.	
Motor voltage	1.2 V ---	
Charging time	240 V \sim	Approx. 8 hours
	230 V \sim	Approx. 10 hours

This product is intended for household use only.

Panasonic Corporation
<http://www.panasonic.com>
© Panasonic Corporation 2017