



# Panasonic®

## Operating Instructions (Household) Rechargeable Shaver

Model No. ES-RT77/ES-RT67/ES-RT47/ES-RT37

English..... 3





Operating Instructions  
(Household) Rechargeable Shaver  
Model No. ES-RT77/ES-RT67/ES-RT47/ES-RT37

## Contents

---

<b>Safety precautions</b> .....	<b>4</b>	<b>Troubleshooting</b> .....	<b>15</b>
<b>Intended use</b> .....	<b>8</b>	<b>Battery life</b> .....	<b>16</b>
<b>Parts identification</b> .....	<b>9</b>	<b>Removing the built-in rechargeable battery</b> .....	<b>16</b>
<b>Charging the shaver</b> .....	<b>9</b>	<b>Specifications</b> .....	<b>16</b>
<b>Using the shaver</b> .....	<b>11</b>		
<b>Cleaning the shaver</b> .....	<b>13</b>		

Thank you for purchasing this Panasonic product.

**Before operating this unit, please read these instructions completely and save them for future use.**

## Safety precautions

To reduce the risk of injury, loss of life, electric shock, fire, and damage to property, always observe the following safety precautions.

### Explanation of symbols

The following symbols are used to classify and describe the level of hazard, injury, and property damage caused when the denotation is disregarded and improper use is performed.



## DANGER

Denotes a potential hazard that will result in serious injury or death.



## WARNING

Denotes a potential hazard that could result in serious injury or death.



## CAUTION

Denotes a hazard that could result in minor injury.

The following symbols are used to classify and describe the type of instructions to be observed.



This symbol is used to alert users to a specific operating procedure that must not be performed.



This symbol is used to alert users to a specific operating procedure that must be followed in order to operate the unit safely.

## IMPORTANT SAFETY INSTRUCTIONS

When using an electrical appliance, basic precautions should always be followed, including the following:

Read all instructions before using this appliance.

### **DANGER** To reduce the risk of electric shock:

1. Do not reach for an appliance that has fallen into water. Unplug immediately.
2. Do not place or store appliance where it can fall or be pulled into a tub or sink. Do not place in or drop into water or other liquid.
3. Except when charging, always unplug this appliance from the electrical outlet immediately after using.
4. Unplug this appliance before cleaning.







### **WARNING** To reduce the risk of burns, fire, electric shock, or injury to persons:

1. Close supervision is necessary when this appliance is used by, on, or near children or invalids.
2. Use this appliance only for its intended use as described in this manual. Do not use attachments not recommended by the manufacturer.

3. Never operate this appliance when it has a damaged cord or plug, when it is not working properly, after it has been dropped or damaged, or after it has been dropped into water. Return the appliance to a service center for examination and repair.
4. Keep the cord away from heated surfaces.
5. Never drop or insert any object into any opening.
6. Do not use outdoors or operate where aerosol (spray) products are being used or where oxygen is being administered.
7. Do not use this appliance with damaged shaving blades and/or foil, as it has the potential to result in facial injury.
8. Always attach plug to appliance first, then to outlet. To disconnect, turn all controls to "off" then remove plug from outlet.

## SAVE THESE INSTRUCTIONS

### **WARNING**

-  **This shaver has a built-in rechargeable battery. Do not throw into fire, apply heat, or charge, use, or leave in a high temperature environment.**  
- Doing so may cause overheating, ignition, or explosion.
-  **Do not connect or disconnect the adaptor to a household outlet with a wet hand.**  
- Doing so may cause electric shock or injury.
-  **Never disassemble except when disposing of the product.**  
- Doing so may cause fire, electric shock, or injury.
-  **Do not use anything other than the supplied AC adaptor. Also, do not charge any other product with the supplied AC adaptor.**  
- Doing so may cause burn or fire due to a short circuit.
-  **Do not modify or repair.**  
- Doing so may cause fire, electric shock, or injury.  
Contact an authorized service center for repair (battery change etc).
-  **Do not store within reach of children or infants. Do not let them use it.**  
- Putting the inner blades, the cleaning brush and/or the oil container in the mouth may cause accidents and injury.
-  **Do not damage, modify, or forcibly bend, pull, or twist the cord.**  
**Also, do not place anything heavy on or pinch the cord.**  
- Doing so may cause electric shock or fire due to a short circuit.

## **WARNING**

-  **Do not use in a way exceeding the rating of the household outlet or the wiring.**
- Exceeding the rating by connecting too many plugs to one household outlet may cause fire due to overheating.

-  **Always ensure the appliance is operated on an electric power source matched to the rated voltage indicated on the AC adaptor.**

**Fully insert the power plug.**  
- Failure to do so may cause fire or electric shock.

-  **Regularly clean the power plug and the appliance plug to prevent dust from accumulating.**

- Failure to do so may cause fire due to insulation failure caused by humidity.  
Disconnect the adaptor and wipe with a dry cloth.

**Immediately stop using and remove the adaptor if there is an abnormality or malfunction.**

- Using it in such conditions may cause fire, electric shock, or injury.

<Abnormality or malfunction cases>

-  **• The main unit, adaptor or cord is deformed or abnormally hot.**
- The main unit, adaptor or cord has burning smell.**
- There is abnormal sound during use or charging of the main unit, adaptor or cord.**
- Immediately request inspection or repair at an authorized service center.

**If oil is consumed accidentally, do not induce vomiting, drink a large amount of water and contact a physician.**

-  **If oil comes into contact with eyes, wash immediately and thoroughly with running water and contact a physician.**
- Failure to follow these instructions may result in physical problems.

**This appliance is not intended for use by persons (including children) with reduced physical, sensory or mental capabilities, or lack of experience and knowledge, unless they have been given supervision or instruction concerning use of the appliance by a person responsible for their safety. Children should be supervised to ensure that they do not play with the appliance.**

- Failure to do so may cause an accident or injury.

-  **The supply cord cannot be replaced. If the cord is damaged, the AC adaptor should be discarded.**

- Failure to do so may cause an accident or injury.

## **CAUTION**

**Do not allow pins or trash to adhere to the power plug or the appliance plug.**

-  **- Doing so may cause electric shock or fire due to a short circuit.**

## CAUTION

 Do not use excessive pressure to apply the system outer foil to your lip or other part of your face. Do not apply the system outer foil directly to blemishes or injured skin.

- Doing so may cause injury to the skin.

 Do not forcefully press the system outer foil. Also, do not touch the system outer foil with fingers or nails when in use.

- Doing so may cause injury to skin or reduce the life of the system outer foil.

 Do not touch the blade section (metallic section) of the inner blade.

- Doing so may cause injury to your hands.

 Do not use this product for hair on head or any other part of the body.

- Doing so may cause injury to skin or reduce the life of the system outer foil.

 Do not share your shaver with your family or other people.

- Doing so may result in infection or inflammation.

 Do not wrap the cord around the adaptor when storing.

- Doing so may cause the wire in the cord to break with the load, and may cause fire due to a short circuit.

 Check the system outer foil for cracks or deformations before use.

- Failure to do so may cause injury to the skin.

 Be sure to place the protective cap on the shaver when carrying around or storing.

- Failure to do so may cause injury to skin or reduce the life of the system outer foil.

 Disconnect the adaptor or the appliance plug by holding onto the adaptor or the appliance plug instead of the cord.

- Failure to do so may cause electric shock or injury.

### ► Disposing of the rechargeable battery

## DANGER

The rechargeable battery is exclusively for use with this shaver. Do not use the battery with other products.

Do not charge the battery after it has been removed from the product.

- Do not throw into fire or apply heat.
- Do not hit, disassemble, modify, or puncture with a nail.

 Do not let the positive and negative terminals of the battery get in contact with each other through metallic objects.

- Do not carry or store the battery together with metallic jewelry such as necklaces and hairpins.
- Do not charge, use, or leave the battery where it will be exposed to high temperatures, such as under direct sunlight or near other sources of heat.
- Never peel off the tube.

- Doing so may cause overheating, ignition, or explosion.

 **WARNING**

**After removing the rechargeable battery, do not keep it within reach of children and infants.**



- The battery will harm the body if accidentally swallowed. If this happens, consult a physician immediately.

**If the battery fluid leaks out, take the following procedures. Do not touch the battery with your bare hands.**



- The battery fluid may cause blindness if it comes in contact with your eyes. Do not rub your eyes. Wash immediately with clean water and consult a physician.
- The battery fluid may cause inflammation or injury if it comes in contact with the skin or clothes. Wash it off thoroughly with clean water and consult a physician.

**Intended use**

- This WET/DRY shaver can be used for wet shaving using shaving lather or for dry shaving. You can use this watertight shaver in the shower and clean with water. The following symbol means suitable for use in a bath or shower.

**► Notes**

- Treat yourself to wet lather shaves for at least three weeks and notice the difference. Your Panasonic WET/DRY shaver requires a little time to get used to because your skin and beard need about a month to adjust to any new shaving method.
- Keep both the inner blades inserted. If only one of the inner blades is inserted, the shaver may be damaged.
- If you clean the shaver with water, do not use salt water or hot water. Do not soak the shaver in water for a long period of time.
- Clean the housing only with a soft cloth slightly dampened with tap water or soapy tap water. Do not use thinner, benzene, alcohol or other chemicals.
- Store the shaver in a place with low humidity after use.
- Do not store the shaver where it will be exposed to direct sunlight or other heat sources.



# Parts identification

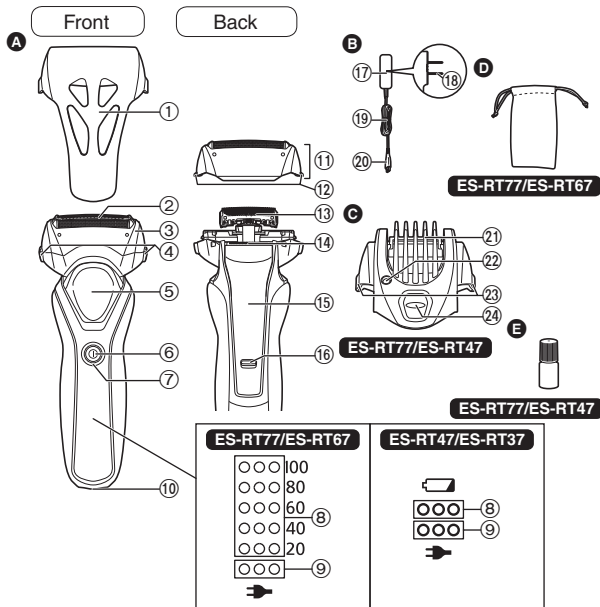

## A Main body

- ① Protective cap
- ② System outer foil
- ③ Foil frame
- ④ Foil frame release buttons
- ⑤ Thumb rest
- ⑥ Power switch
- ⑦ Switch on lamp

### ES-RT77/ES-RT67

- ⑧ Battery capacity lamp
- ⑨ Charge status lamp (➔)
- ⑩ Appliance socket
- ⑪ Outer foil section
- ⑫ System outer foil release buttons
- ⑬ Inner blades
- ⑭ Trimmer
- ⑮ Trimmer handle
- ⑯ Lock release button

## B AC adaptor (RE7-59)

- ⑰ Adaptor
- ⑱ Power plug
- ⑲ Cord
- ⑳ Appliance plug

## C Comb attachment

### ES-RT77/ES-RT47

- ㉑ Comb
- ㉒ Trimming height window
- ㉓ Comb attachment release buttons
- ㉔ Trimming height switch button

## Accessories

## D Travel pouch

### ES-RT77/ES-RT67

## E Oil ES-RT77/ES-RT47

# Charging the shaver

## 1 Insert the appliance plug into the shaver.

- Turn the shaver off before inserting.

## 2 Plug in the adaptor into a household outlet.

- Wipe off any water droplets on the appliance socket.

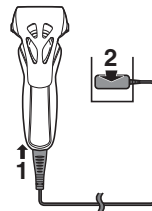

## 3 Disconnect the adaptor after charging is completed.

- Charging is completed after approx. 1 hour.  
The charging time may differ with the charging capacity.

- Charging the battery for more than 1 hour will not affect battery performance.
- Top-up charging will not cause reductions in battery performance.
- If the shape of the plug does not fit the power outlet, use an attachment plug adaptor of the proper configuration.

**Note**

You cannot operate the shaver while charging.

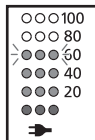
**While charging****ES-RT77/ES-RT67**

The charge status lamp (⇒) glows.

The number of the battery capacity lamp will increase as charging progresses.

**ES-RT47/ES-RT37**

The charge status lamp (⇒) glows.

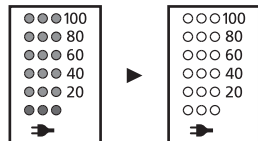
**After charging is completed****ES-RT77/ES-RT67**

All the battery capacity lamps light up for 5 seconds and then all lamps turn off.

**ES-RT47/ES-RT37**

The charge status lamp (⇒) turns off.

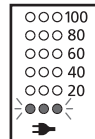
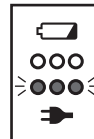
**Abnormal charging****ES-RT77/ES-RT67****ES-RT47/ES-RT37**

The charge status lamp (⇒) blinks twice every second.

- After charging is completed, turning the power switch ON with the shaver plugged in will cause the charge status lamp (⇒) to light up and then turn off after 5 seconds. This shows that the shaver is fully charged.
- Recommended ambient temperature for charging is 10 – 35 °C (50 – 95 °F). It may take longer to charge or the battery may fail to charge properly in extremely high or low temperatures. Charge the shaver within the recommended ambient temperature range.
- When charging the shaver for the first time or when it has not been in use for more than 6 months, the charging time may change or the charge status lamp (⇒) may not glow for a few minutes. It will eventually glow if kept connected.

## Using the shaver

- Do not place your fingers on the power switch while using the shaver. This may cause the shaver to turn off. Place your fingers on the thumb rest while using the shaver.
- We recommend using the shaver in an ambient temperature range of 5 – 35 °C (41 – 95 °F). If used outside this range, the appliance may stop operating.

### 1 Press the power switch.

- The switch on lamp glows. **ES-RT77/ES-RT67**

### 2 Hold the shaver as illustrated and shave.

- Start shaving by applying gentle pressure to your face. Stretch your skin with your free hand and move the shaver back and forth in the direction of your beard. You may gently increase the amount of pressure as your skin becomes accustomed to this shaver. Applying excessive pressure does not provide a closer shave.

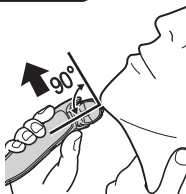

## Using the trimmer

### ► Trimming sideburns

Slide the trimmer handle up. Turn the shaver on and place at a right angle to your skin and move downwards to trim your sideburns.

- Press and hold the lock release button and slide the trimmer handle down to lower the trimmer.

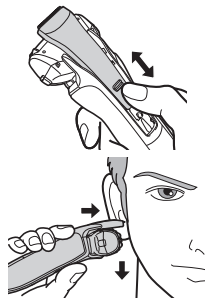

### ► Pre-shave

The trimmer can be used for a pre-shave of long beards.

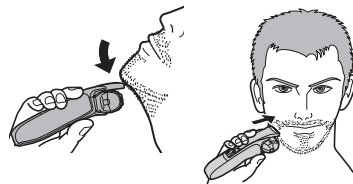

### ► Above the lips

Turn the shaver on and place at a right angle to your skin and trim around your moustache.

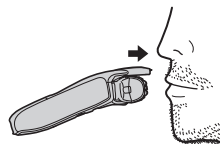

### ► Trimming the edge of beard

Cut your beard gradually with the power switch facing opposite side of your skin, taking care not to cut too much.

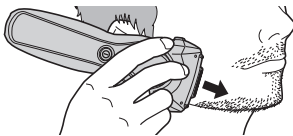

### Using the comb attachment **ES-RT77/ES-RT47**

#### Note

Apply the oil to the trimmer before and after each use. (See page 14.)

Failure to apply the oil may cause the following problems due to rust, wear or burn out.

- The trimmer has become blunt.
- Shorter operating time.
- Louder sound.

Make sure that the shaver is turned off.

### 1 Mount the comb attachment to the main body until it clicks.

- Press and hold the comb attachment release buttons to remove.

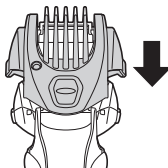

### 2 Slide the trimmer handle up until it clicks.

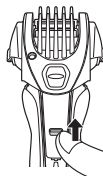

### 3 While pressing and holding the trimming height switch button, move the comb vertically to the desired trimming length (between 1 mm (1/32") and 7 mm (9/32")).



Trimming height (approx.)	mm	1.0	2.5	4.0	5.5	7.0
	inch	1/32	3/32	5/32	7/32	9/32
Indicator		1.0	2.5	4.0	5.5	7.0

- Actual hair length will be a little longer than the height you set.

### 4 Lightly push the comb attachment to ensure that it has locked into place.



### 5 Turn the shaver on, bring the comb of the comb attachment into contact with the skin, and cut the beard by moving the trimmer back against the flow of the beard.

**Notes**

- Be careful not to cut your hand on the blade when attaching and removing the comb attachment.
- Do not use with shaving creams applied or when the beard is wet. Wet beard can stick to the skin or clump making it difficult for the blade to cut.
- Comb beard and sideburns before trimming.
- Hair trimmings may collect inside the comb attachment when a large volume of beard is cut, so discard hair trimmings after each use.
- If the comb attachment is not attached properly, it may become loose during use resulting in excessive cutting.

**Reading lamps when using**

During use

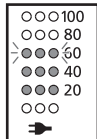
**ES-RT77/ES-RT67**

Approximate amount of battery charge is displayed as 20 – 100.

- It turns off after approximately 5 seconds.

**ES-RT47/ES-RT37**

All lamps disappear while using.

When the battery capacity is low

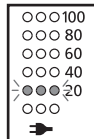
**ES-RT77/ES-RT67**

“20” blinks for 5 seconds when the power switch is pressed.

**ES-RT47/ES-RT37**

The battery capacity lamp blinks for 5 seconds when the power switch is pressed.

- You can shave 2 to 3 times after “20” blinks. (This will differ depending on usage.) **ES-RT77/ES-RT67**
- You can shave 2 to 3 times after the battery capacity lamp blinks. (This will differ depending on usage.) **ES-RT47/ES-RT37**
- A full charge will supply enough power for approx. 18 shaves of 3 minutes each. (This will differ depending on usage.)

**Cleaning the shaver**

1. Disconnect the cord from the shaver.
2. Apply some hand soap and some water to the system outer foil.
3. Turn the shaver on.
4. Turn off the shaver after 10 to 20 seconds.



5. Remove the outer foil section.

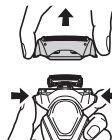

6. Clean the shaver, the outer foil section, the trimmer, and the comb attachment with running water.

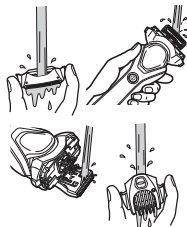

7. Wipe off any drops of water with a dry cloth.

8. Dry the outer foil section, the shaver, the trimmer, and the comb attachment completely.



9. Attach the outer foil section to the shaver.

10. Lubricate the shaver.

## Lubrication (Oil included for ES-RT77/ES-RT47)

To maintain shaving comfort for a long time, it is recommended that the oil provided with the shaver is used.

1. Switch off the shaver.
2. Apply one drop of oil to each system outer foil.
3. Raise the trimmer and apply one drop of oil.
4. Switch the shaver on, and run it for approximately five seconds.
5. Switch off the shaver, and wipe off any excess oil from the system outer foil with a soft cloth.

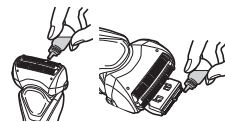

## Replacing the system outer foil and the inner blades

system outer foil	once every year
inner blades	once every two years

### ► Removing the outer foil section

Press the foil frame release buttons and lift the outer foil section upwards.

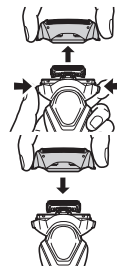

### ► Attaching the outer foil section

Securely attach the outer foil section to the shaver until it clicks.

### ► Replacing the system outer foil

- Press the system outer foil release buttons and pull down the system outer foil.
- Insert the system outer foil until it clicks.
  - Always attach the system outer foil in proper direction.
  - Always insert the system outer foil to the foil frame when attaching to the shaver.

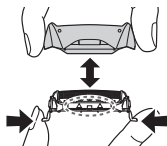

### ► Replacing the inner blades

- Remove the inner blades one at a time.
  - Do not touch the edges (metal parts) of the inner blades to prevent injury to your hand.
- Insert the inner blades one at a time until they click.

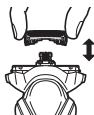

### ► Replacement parts

Replacement parts are available at your dealer or Service Center.

Replacement parts for ES-RT77/ES-RT67/ ES-RT47/ES-RT37	System outer foil and inner blades	WES9013
	System outer foil	WES9087
	Inner blades	WES9068

## Troubleshooting

Problem	Action
Shavings fly all over.	► This can be improved by cleaning every time after shaving.
	► Clean the inner blades.

Problem	Action
System outer foil gets hot.	► Apply oil. (See page 14.)
	► Replace the system outer foil if it is damaged or deformed. (See this page.)
Operating time is short even after charging.	► Apply oil.
	► When the number of operations per charge starts to decrease, the battery is nearing the end of its life.
Makes a loud sound.	► Apply oil.
	► Confirm that the blades are properly attached.
	► Clean the system outer foil.
The odor is getting stronger.	► This can be improved by cleaning every time after shaving.
	► This can be improved by cleaning every time after shaving.
You do not get as close a shave as before.	► Replace the system outer foil and/or inner blades. Expected life of system outer foil and inner blades: System outer foil: Approximately 1 year Inner blades: Approximately 2 years
	► Apply oil.

Problem	Action
Shaver stopped functioning.	▶ Recommended ambient temperature for operation is 5 – 35 °C (41 – 95 °F). The shaver may stop functioning when out of recommended ambient temperature range.
	▶ The battery has reached the end of its life.

If the problems still cannot be solved, contact the store where you purchased the unit or a service center authorized by Panasonic for repair.

## Battery life

The life of the battery is 3 years. The battery in this shaver is not intended to be replaced by consumers.

## Removing the built-in rechargeable battery

### ATTENTION:

A lithium ion battery that is recyclable powers the product you have purchased. Please call 1-800-8-BATTERY for information on how to recycle this battery.



**Remove the built-in rechargeable battery before disposing of the shaver.**

This figure must only be used when disposing of the shaver, and must not be used to repair it. If you dismantle the shaver yourself, it will no longer be waterproof, which may cause it to malfunction.

- Remove the shaver from the AC adaptor.
- Press the power switch to turn on the power and then keep the power on until the battery is completely discharged.
- Perform steps ① to ⑤ and lift the battery, and then remove it.
- Please take care not to short-circuit the battery.

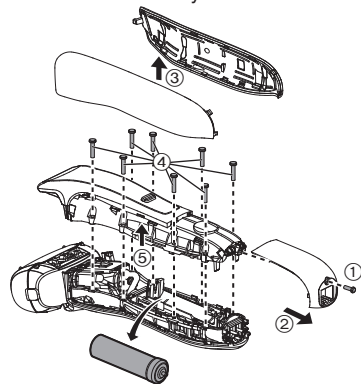

## Specifications

Power source	See the name plate on the AC adaptor. (Automatic voltage conversion)
Motor voltage	3.6 V---
Charging time	Approx. 1 hour

This product is intended for household use only.



**Federal Communication Commission Interference Statement**

This equipment has been tested and found to comply with the limits for a Class B digital device, pursuant to Part 15 of the FCC Rules. These limits are designed to provide reasonable protection against harmful interference in a residential installation. This equipment generates, uses and can radiate radio frequency energy and, if not installed and used in accordance with the instructions, may cause harmful interference to radio communications. However, there is no guarantee that interference will not occur in a particular installation. If this equipment does cause harmful interference to radio or television reception, which can be determined by turning the equipment off and on, the user is encouraged to try to correct the interference by one of the following measures:

- Reorient or relocate the receiving antenna.
- Increase the separation between the equipment and receiver.
- Connect the equipment into an outlet on a circuit different from that to which the receiver is connected.
- Consult the dealer or an experienced radio/TV technician for help.

FCC Caution: To assure continued compliance, install and use in accordance with provided instructions. Any changes or modifications not expressly approved by the party responsible for compliance could void the user's authority to operate this equipment.

This device complies with part 15 of the FCC Rules. Operation is subject to the following two conditions: (1) This device may not cause harmful interference, and (2) this device must accept any interference received, including interference that may cause undesired operation.

**Personal Care & Beauty Care Products****FOR USA AND PUERTO RICO ONLY****30-Day Quality  
Satisfaction Guarantee**

If you are dissatisfied with any Panasonic Personal Care & Beauty Care Products for any reason, simply return it to the place of purchase with a dated proof of purchase, in the original packaging, with all accessories, parts and instructions, within 30 days of the date of purchase, for a full refund, or call Panasonic at 1-800-338-0552.

Abuse or misapplication of this product voids the guarantee.

**FOR YOUR CONVENIENCE, WE HAVE ESTABLISHED A  
TOLL-FREE (IN USA ONLY) NATIONAL ACCESSORY  
PURCHASE HOT LINE AT 1-800-332-5368.**

**IN USA CONTACT:**

Panasonic Corporation of North America  
Two Riverfront Plaza, Newark, NJ 07102-5490

**IN CANADA CONTACT:****AU CANADA, COMMUNIQUEZ AVEC:**

Panasonic Canada Inc.  
5770 Ambler Drive, Mississauga, Ontario L4W 2T3  
www.panasonic.com

**EN MEXICO CONTACTE CON:**

Panasonic de México S.A. de C.V.  
Félix Cuevas No. 6 Piso 2 y 3  
Col. Tlacoquemecatl Del Valle  
Del. Benito Juárez  
México, D.F. C.P.03200  
01 (55) 5488-1000

**EN PANAMA CONTACTE CON:**

Panasonic Latin America. S.A.  
P.O. Box 0816-03164  
Panama, Republic of Panama  
(507) 229-2955

**Service • Assistance • Accessories**  
**Dépannage • Assistance • Accessoires**

**Call 1-800-338-0552 (In USA)**

**<http://shop.panasonic.com/personal-care> <http://shop.panasonic.com/support>**

**[www.panasonic.ca/english/support](http://www.panasonic.ca/english/support) (In Canada)**

**[www.panasonic.ca/french/support](http://www.panasonic.ca/french/support) (Au Canada)**

**<http://www.panasonic.com>**